



Citrix Virtual Apps and Desktops 7 2402 LTSR

Contents

Citrix Virtual Apps and Desktops 7 2402 LTSR	14
Fixed issues	22
Known issues	25
Deprecation	29
System requirements	43
Technical overview	54
Databases	64
Delivery methods	71
Network ports	76
HDX	76
Citrix ICA virtual channels	86
Double hop in Citrix Virtual Apps and Desktops	96
Install and configure	99
Machine identities	101
Active Directory joined	103
Hybrid Azure Active Directory joined	106
Prepare to install	109
AWS cloud environments	119
XenServer virtualization environments	125
Google Cloud environments	126
HPE Moonshot virtualization environments	138
Microsoft Azure Resource Manager cloud environments	140
Microsoft System Center Configuration Manager environments	141

Microsoft System Center Virtual Machine Manager virtualization environments	143
Nutanix virtualization environments	146
Nutanix cloud and partner solutions	147
VMware virtualization environments	149
VMware cloud and partner solutions	150
Install core components	177
Install using the command line	190
Install Web Studio	206
Install VDAs	214
Configure Windows Defender Access Control related to VDA Installation	232
Install VDAs using scripts	234
Install VDAs using SCCM	236
Create a site	240
Create and manage connections and resources	244
Connection to AWS	260
Connection to XenServer	273
Connection to Google cloud environments	276
Connection to HPE Moonshot	289
Connection to Microsoft Azure	293
Connection to Microsoft System Center Virtual Machine Manager	313
Connection to Nutanix	314
Connection to Nutanix cloud and partner solutions	315
Connection to VMware	317
Connection to VMware cloud and partner solutions	325

Image management (Preview)	325
Create machine catalogs	344
Create an AWS catalog	372
Create a XenServer catalog	383
Create a Google Cloud Platform catalog	386
Create an HPE Moonshot machine catalog	409
Create a Microsoft Azure catalog	411
Create a Microsoft System Center Virtual Machine Manager catalog	476
Create a Nutanix catalog	479
Create a VMware catalog	481
Create catalogs of different join types	486
Create Hybrid Azure Active Directory joined catalogs	487
Manage machine catalogs	490
Manage an AWS catalog	514
Manage a XenServer catalog	518
Manage a Google Cloud Platform catalog	519
Manage an HPE Moonshot catalog	524
Manage a Microsoft Azure catalog	525
Manage a Microsoft System Center Virtual Machine Manager catalog	540
Manage a VMware catalog	541
Power Management	545
Power manage AWS VMs	546
Power manage Azure VMs	549
Security policies	563

Security groups	563
Secure boot	564
Encryption capabilities	566
Create delivery groups	567
Manage delivery groups	575
Create application groups	602
Manage application groups	610
Remote PC Access	617
Publish content	634
Server VDI	638
User personalization layer	640
Remove components	657
Upgrade and migrate	658
Upgrade a deployment	662
Secure	685
FIDO2 and WebAuthn authentication	686
Integrate Citrix Virtual Apps and Desktops with Citrix Gateway	690
Security considerations and best practices	691
Smart cards	699
Smart card deployments	707
Pass-through authentication and single sign-on with smart cards	713
Transport Layer Security (TLS)	715
Transport Layer Security (TLS) on Universal Print Server	732
Virtual channel allow list	743

WebSocket communication between VDA and Delivery Controller	746
HDX connectivity	748
Adaptive transport	749
Enlightened Data Transport	752
Troubleshooting	753
HDX Direct (Preview)	757
NAT Compatibility	763
Troubleshooting	765
Virtual channel allow list	769
Troubleshooting	772
Known third-party virtual channels	775
Devices	776
Scanning	777
TWAIN Redirection	778
WIA devices	780
Generic USB devices	781
Configuration	782
Composite Devices and Device Splitting	786
Troubleshooting	790
USB Diagnostics Tool	795
Legacy USB Redirection Configuration	800
Client Drive Mapping (CDM)	805
Support for mobile and touch screen client devices	807
Serial ports	810

Specialty keyboards	815
Webcams	817
Graphics	818
10-Bit High Dynamic Range (HDR)	820
HDX 3D Pro	822
GPU acceleration for Windows multi-session OS	825
GPU acceleration for Windows single-session OS	827
Thinwire	833
Text-based session watermark	842
Screen sharing	843
Virtual display layout	847
Adaptive Refresh Rate	850
Loss tolerant mode for graphics	852
Multimedia	852
Audio features	856
Browser content redirection	867
HDX video conferencing and webcam video compression	877
HTML5 multimedia redirection	880
Optimization for Microsoft Teams	883
Monitor, troubleshoot, and support Microsoft Teams	926
Windows Media redirection	934
General content redirection	934
Client folder redirection	935
Client location redirection	936

Bidirectional content redirection	938
Host to client redirection	940
Local App Access and URL redirection	944
Generic USB redirection and client drive considerations	952
Print	962
Printing configuration example	971
Best practices, security considerations, and default operations	974
Printing policies and preferences	976
Provision printers	978
Maintain the printing environment	988
Policies	992
Work with policies	994
Policy templates	998
Create policies	1002
Policy sets	1009
Compare, prioritize, and troubleshoot policies	1011
Default policy settings	1016
Policy settings reference	1045
ICA policy settings	1049
Auto client reconnect policy settings	1059
Audio policy settings	1061
Bandwidth policy settings	1063
Bidirectional content redirection policy settings	1068
Browser content redirection policy settings	1076

Client sensors policy settings	1083
Desktop UI policy settings	1084
End user monitoring policy settings	1085
Enhanced desktop experience policy setting	1086
File Redirection policy settings	1087
Graphics policy settings	1092
Caching policy settings	1099
Framehawk policy settings	1099
Keep alive policy settings	1100
Local App Access policy settings	1101
Mobile experience policy settings	1102
Multimedia policy settings	1103
Multi-stream connections policy settings	1111
Port redirection policy settings	1114
Printing policy settings	1115
Client printers policy settings	1119
Drivers policy settings	1123
Universal Print Server policy settings	1124
Universal printing policy settings	1131
Security policy settings	1134
Server limits policy settings	1135
Session limits policy settings	1136
Session reliability policy settings	1138
Session watermark policy settings	1140

Time zone control policy settings	1143
TWAIN devices policy settings	1145
USB devices policy settings	1146
Virtual channel allow list policy settings	1155
Visual display policy settings	1157
Moving images policy settings	1158
Still images policy settings	1160
WebSockets policy settings	1162
WIA devices policy settings	1163
HDX features managed through the registry	1163
Load management policy settings	1179
Profile Management policy settings	1181
Advanced policy settings	1181
Basic policy settings	1189
Cross-platform policy settings	1194
File system policy settings	1195
Exclusions policy settings	1196
Synchronization policy settings	1198
Folder redirection policy settings	1200
AppData(Roaming) policy settings	1200
Contacts policy settings	1201
Desktop policy settings	1201
Documents policy settings	1202
Downloads policy settings	1203

Favorites policy settings	1203
Links policy settings	1204
Music policy settings	1205
Pictures policy settings	1205
Saved Games policy settings	1206
Start menu policy settings	1207
Searches policy settings	1207
Video policy settings	1208
Log policy settings	1209
Profile handling policy settings	1214
Registry policy settings	1218
Streamed user profiles policy settings	1219
User personalization layer policy settings	1221
Virtual Delivery Agent policy settings	1221
HDX 3D Pro policy settings	1223
Monitoring policy settings	1224
Virtual IP policy settings	1229
Configure COM Port and LPT Port Redirection settings using the registry	1230
Connector for Configuration Manager 2012 policy settings	1231
Manage	1234
Applications	1236
App packages	1247
Universal Windows Platform Apps	1258
Autoscale	1261

Getting started with Autoscale	1262
Schedule-based and load-based settings	1269
Dynamic session timeouts	1287
Autoscaling tagged machines (cloud burst)	1289
User logoff notifications (formerly force user logoff)	1299
Broker PowerShell SDK commands	1301
Citrix Insight Services	1304
Citrix Scout	1315
Collect a Citrix Diagnostic Facility (CDF) trace at system startup	1339
Delegated administration	1342
Delivery Controllers	1351
IPv4/IPv6 support	1355
Licensing for Citrix Virtual Apps and Desktops using Web Studio	1356
Multi-type licensing	1361
FAQ for licensing	1369
Load balance machines	1381
Local Host Cache	1382
Manage security keys	1397
Sessions	1411
Tags	1418
Use Search in Studio	1429
Settings	1433
User profiles	1437
VDA registration	1443

Virtual IP and virtual loopback	1454
Zones	1458
Monitor	1470
Configuration logging	1471
Event logs	1478
Director	1479
Install and configure	1484
Advanced configuration	1486
Configure PIV smart card authentication	1490
Configure network analysis	1496
Delegated administration and Director	1498
Secure Director deployment	1501
Configuring on-premises sites with Citrix Analytics for Performance	1504
Site Analytics	1511
Alerts and notifications	1521
Filter data to troubleshoot failures	1531
Monitor historical trends across a site	1533
Monitor Autoscale-managed machines	1539
Troubleshoot deployments	1541
Troubleshoot applications	1542
Troubleshoot machines	1545
Troubleshoot user issues	1553
Diagnose session startup issues	1559
Diagnose user logon issues	1564

Diagnose Session Performance issues	1571
Shadow users	1575
Send messages to users	1576
Resolve application failures	1577
Restore desktop connections	1578
Restore sessions	1579
Run HDX channel system reports	1579
Reset a user profile	1580
Record sessions	1584
Feature compatibility matrix	1587
Data granularity and retention	1591
Citrix Director failure reasons and troubleshooting	1598
Third party notices	1619
SDKs and APIs	1619

Citrix Virtual Apps and Desktops 7 2402 LTSR

April 11, 2024

About the release

The Long Term Service Release (LTSR) program for Citrix Virtual Apps and Desktops provides stability and long-term support for Citrix Virtual Apps and Desktops releases.

LTSRs are also available for Citrix Virtual Apps and Desktops 2203 and 1912.

This Citrix Virtual Apps and Desktops release includes new versions of the Windows Virtual Delivery Agents (VDAs) and new versions of several core components. You can:

- **Install or upgrade a site:** Use the ISO for this release to install or upgrade core components and VDAs. Installing or upgrading to the latest version allows you to use the latest features.
- **Install or upgrade VDAs in an existing site:** If you already have a deployment and aren't ready to upgrade your core components, you can still use several of the latest HDX features by installing (or upgrading to) a new VDA. Upgrading only the VDAs can be helpful when you want to test enhancements in a non-production environment.

After upgrading your VDAs to this version, you do not need to update the machine catalog's functional level. For more information, see [VDA versions and functional levels](#).

For installation and upgrade instructions:

- If you are building a new site, follow the sequence in [Install and configure](#).
- If you are upgrading a site, see [Upgrade a deployment](#).

Citrix Virtual Apps and Desktops 7 2402 LTSR

New HDX Graphics policy - Allow Windows screen lock

With the new **Allow Windows** screen lock policy in HDX Graphics, you now have the option to modify Windows display timeouts in a Citrix Virtual Desktop session on Workstation OS as per your requirement.

For more information, see [Allow Windows screen lock](#).

New loss tolerant mode for audio policy

Loss tolerant mode for audio is now available to allow audio delivery through the loss tolerant mode policy.

For more information, see [Loss tolerant mode for audio](#).

Signed third-party binaries

Binaries distributed by Citrix are now signed. Signed binaries indicate that they are validated by either Citrix-generated certificates or authentic third-party certificates. For more information, see [Install VDAs](#).

Enhanced system logs for browser content redirection

With the enhancements to the system logs, browser content redirection now allows admins to monitor the feature status. For more information, see [How to troubleshoot browser content redirection](#).

Enhanced bidirectional content redirection configuration

Previously, configuring bidirectional content redirection involved managing three distinct policies: Allow bidirectional content redirection, Allow redirection of URLs to VDA, and Allow redirection of URLs to the Client. These policies require configurations on both the server side and the client side (configured through Group Policies). Starting with this release, we have consolidated all three policies into a single, unified policy. It not only simplifies and enhances the configuration process but also eliminates the requirement for client-side configurations.

For more information, see [Bidirectional content redirection configuration](#).

Citrix Secure Private Access for on-premises

Citrix Secure Private Access for on-premises is now generally available as part of the Citrix Virtual Apps and Desktops 2402 release. The Secure Private Access on-premises solution includes a full-service admin console UI with a similar look and feel as the Secure Private Access service. For details, see [Citrix Secure Private Access for on-premises –General Availability](#).

HDX Reducer

You can now configure the version of the HDX compression algorithm, or Reducer, that you want to use in the session host.

For more information, see [HDX Reducer](#).

New HDX registry setting for configuring EDT timeout

You now have the option to configure EDT timeout by setting the registry. For more information, see [Configure EDT timeout](#).

Microsoft Teams Optimization - whitelisted registry entry

Starting with Citrix Virtual Apps and Desktops 2402, you no longer need to manually configure the `msedgewebview2.exe` registry entry as it is now whitelisted by default.

For more information, see the [Microsoft](#) documentation.

Virtual Delivery Agents (VDAs) 2402 LTSR

Option to install, upgrade, or uninstall Citrix Workspace App during VDA installation, upgrade, or uninstallation

This feature allows you to choose to install, upgrade, or uninstall the Citrix Workspace App during a VDA installation, upgrade, or uninstallation in the following scenarios:

- During a VDA installation, you can choose to install the Citrix Workspace App. By default, Citrix Workspace App is not installed during the VDA installation.
- During a VDA upgrade, if Citrix Workspace App is not already installed in the VDA, you can choose to install Citrix Workspace App.
- During a VDA upgrade, if the version of Citrix Workspace App can be upgraded, then the option to upgrade Citrix Workspace App is displayed.
- During a VDA uninstallation, you can choose to not uninstall the Citrix Workspace App. By default, the Citrix Workspace App is uninstalled during the VDA uninstallation. For more information, see [Select the components to install and the installation location](#) and [Command-line options for installing a VDA](#)

WebSocket support for VDAs

Citrix Virtual Apps and Desktops now allow you to use WebSocket technology over the Citrix Brokering Protocol (CBP) to facilitate communication between VDAs and Delivery Controllers. This feature offers the following benefits:

- Requires only the TLS port 443 for communication from the VDA to the Delivery Controller.
- Access non-domain joined VDAs also through Citrix Virtual Apps and Desktops.

For more information, see [WebSocket communication between VDA and Delivery Controller](#).

Support VDA Updates from a local file share that VDAs have access (Preview)

You can now support VDA updates from a local file share and specify the VDA installer location through PowerShell commands. For more information, see [Support VDA updates from Local File Share](#).

Web Studio

Support for provisioning VMware VMs using machine profiles

When provisioning VMware VMs using the Machine Creation Service (MCS), you can now select an existing template as the machine profile, letting the VMs within the catalog inherit settings from the selected template.

The inherited settings include:

- Tags placed on the template
- Custom attributes
- vSAN Storage policies
- Virtual hardware version
- vSphere Virtual TPM (vTPM)
- CPU count and core per socket
- NIC count

For more information, see [Creating machine catalogs](#).

Managing prepared images with the Images node

An **Images** node is now available in Web Studio, letting you prepare an MCS image (prepared image) from a single source image and deploy it across various MCS machine catalogs. This node facilitates complete image lifecycle management, enabling you to create image definitions, versions, and catalogs.

Images prepared using this node can only be used in Azure and VMware environments. For detailed information on image management, see [Image management \(Preview\)](#).

Alternatively, you can also create catalogs with prepared images using the **Machine Catalogs** node. For more information, see [Creating machine catalogs](#).

Deprecated features

The following features and settings have been deprecated in Web Studio:

- Azure environments:

Provisioning VMs using a master image from a different region has been deprecated. We recommend using Azure Compute Gallery to replicate the master image to the region where the VMs will be created.

- AWS environments:

The option **Apply machine template properties to virtual machines**, on the **Machine Catalog Setup > Machine Template** page, has been deprecated. We recommend using machine profiles to specify machine properties for VMs instead.

- All hypervisor and cloud service environments:

Configuring the write-back cache with only a disk cache and no memory cache has been deprecated. We recommend setting the memory cache size to a value greater than zero.

Citrix Director

Secure Private Access integration with Director (Preview)

The Secure Private Access integration with Director allows help desk admin or full admin to monitor and troubleshoot all Secure Private Access sessions in Director. To support this feature, you must use the 2402 or later versions of Director, Secure Private Access, Citrix Workspace app, and VDA.

Available actions include viewing the details of the following:

- Secure Private Access active sessions for a user under the **Select a Session** popup > **Sessions** tab > **Web Apps and SaaS Apps**
- Secure Private Access failed or blocked enumerations and failed app launches under the **Select a Session** popup > **Denied Access** tab
- Session and application details view for active and failed app launches
- Session and application details view for failed and blocked enumerations

For more information, see [Secure Private Access integration with Director \(Preview\)](#) page.

Enhanced Performance Metrics panel

The **Performance Metrics** panel has an enhanced visualization of the real-time metrics. When you click the **Session Performance** tab, along with the real time data, you can view the last 15-minutes data without waiting for the page load time. This enhancement helps to reduce mean time for resolution by enabling admins to be able to correlate multiple component performance metrics in a single view. For more information, see [Performance metrics](#) section.

Support for newer version of Microsoft Teams

Citrix Monitor now supports Microsoft Teams version 2.1 or earlier.

Machine Creation Services (MCS)

Image management (Preview)

With the image management functionality, MCS separates the mastering phase from the overall provisioning workflow.

You can prepare an MCS image (Prepared Image) from a single source image and use it across multiple different MCS machine catalogs. This implementation significantly reduces the storage and time costs, and simplifies the VM deployment and image update process.

The benefits of using this image management functionality are:

- Generate prepared images in advance without creating a catalog.
- Reuse prepared images in multiple scenarios, such as creating and updating a catalog.
- Significantly reduce catalog creation or update time.

For detailed information on image management, see [Image management \(Preview\)](#).

Check for multiple NICs in VMware

In VMware environments, we have introduced various pre-flight checks when the hosting unit and machine profile template have multiple networks, and the `-NetworkMapping` parameter is used in the `New-ProvScheme` and `Set-ProvScheme` commands. For more information on the pre-flight checklist for multiple NICs, see [Check for multiple NICs](#).

Support for creating Windows 11 VMs in GCP

You can now create Windows 11 VMs in GCP. If you install Windows 11 on the master image, then you must enable vTPM during the master image creation process. Also, you must enable vTPM on the machine profile source (VM or instance template).

This feature is applicable to:

- Persistent and Non-persistent MCS machine catalogs
- Only sole-tenant node group

For information on creating Windows 11 VMs on the sole-tenant node, see [Create Windows 11 VMs on the sole-tenant node](#).

Profile Management

For information about new features, see the [What's new](#) article in its own document.

Linux VDA

For information about new features, see the [What's new](#) article in its own document.

Session Recording

For information about new features, see the [What's new](#) article in its own document.

Workspace Environment Management

For information about new features, see the [What's new](#) article in its own document.

Citrix Provisioning

For information about new features, see the [What's new](#) article in its own document.

Federated Authentication Service

For information about new features, see the [What's new](#) article in its own document.

2402 LTSR initial release baseline components

2402 baseline component	Version as shown in Programs and Features	Documentation
Single-session VDA	2402.0.4000.4310	Single-session VDA
Multi-session VDA	2402.0.4000.4310	Multi-session VDA
Delivery Controller	2402.0.4000.4310	Delivery Controller
Citrix Studio	7.33.4000.15	Citrix Studio
Citrix Director	7.33.4000.26	Citrix Director
Citrix Group Policy Management	7.33.4000.2	Citrix Group Policy Management

2402 baseline component	Version as shown in Programs and Features	Documentation
Citrix Group Policy Client-Side Extension	7.33.4000.5	
Citrix StoreFront	2402.0.4000.13	Citrix StoreFront
Citrix Provisioning	7.33.40	Citrix Provisioning
Universal Print Server	7.33.4000.11	Universal Print Server
Session Recording	22.3.4000	Session Recording
Linux VDA	22.03.3000.6	Linux Virtual Delivery Agent
Profile Management	22.3.4000.7	Profile Management
Citrix Federated Authentication Service	10.9.4000.6	Citrix Federated Authentication Service (FAS)
Browser Content Redirection	15.32.4000.12	Browser Content Redirection
Citrix Probe Agent 2305	2305.1.0.0	Download

2402 LTSR initial release compatible components

The following components - at the versions given below - are compatible with LTSR environments. They aren't eligible for the LTSR benefits (extended lifecycle and fix-only cumulative updates). Citrix might ask you to upgrade to a newer version of these components within your 2402 environments.

Compatible components and features	Version as shown in Programs and Features	Documentation
App Layering	2309	Citrix App Layering
HDX RealTime Optimization Pack	2.9.600	HDX RealTime Optimization Pack
License Server	11.17.2.0_BUILD_44000	License Server
User personalization layer	23.9.1	User personalization layer
Session Recording web player	22.3.4000.4	Session recording web player
Microsoft Teams optimization	15.32.3000.9	Microsoft Teams optimization
Workspace Environment Management	22.12.0	Workspace Environment Management

2402 LTSR initial release notable exclusions

The following features, components, and platforms aren't eligible for 2402 lifecycle milestones and benefits. Specifically, cumulative updates and extended lifecycle benefits are excluded. Updates to excluded features and components are available through regular current releases.

Excluded components and features

AppDisks

AppDNA

Citrix SCOM Management Pack

Framehawk

Personal vDisk

StoreFront Citrix Online Integration

Excluded Windows platforms *

Windows 2008 32-bit (for Universal Print Server)

* Citrix reserves the right to update platform support based on third-party vendors' lifecycle milestones.

Fixed issues

April 16, 2024

Citrix Virtual Apps and Desktops 7 2402 LTSR includes the following fixed issues:

General

- When the name of the audio device is more than 200 characters, the device might fail to redirect to the virtual session. [HDX-58341]
- For webcam redirection, the RDP client to the second hop is not supported. [HDX-55630]
- When you scan an image in a desktop session with the environment configured as described below, the image might not get scanned. This issue is intermittent.

- Scanner driver and imaging application installation.
- USB direction policy enabled on DDC.
- Environment setup:
 - * DDC: Win2k19 + 7.33CU4
 - * VDA: Win2k19/Win2k16+ 7.40.0.191
 - * Client: Win10x64 22H2 + CWA 24.1.0.597

[HDX-58888]

- Launch of a second seamless app fails if SSL is enabled and session reliability is turned off. If a seamless app is launched, the subsequent launch of another seamless app to the same server must be launched in the existing session (session sharing), while the client tends to launch the app in a new session causing an unexpected validate request to be sent to the broker. [HDX-52439].
- If you are using mono audio for stereo audio streams, you might hear only one audio channel in one earpiece instead of receiving both channels on both ears. [HDX-56344]

Delivery Controller

- Updates on the MonitorData.ResourceUtilization table in the monitoring database are delayed. [CVADHELP-24523]

Graphics

For Windows 11 version 22H2, when moving a Windows Media Player window within a session, only the bottom half of the video is displayed. As a workaround, select: Settings > System > Multitasking > Snap windows > Show snap layouts when I drag a window to the top of my screen [HDX-42092]

Policy

- After you upgrade Citrix Virtual Apps and Desktops from version 1912 LTSR CU3 to version CU4 or CU5, VDAs might not register with Delivery Controller and remain unregistered. [CVADHELP-19834]

Studio

- Custom admins who do not have the 'All' scope cannot edit or delete policies from the default policy set. As a workaround, add a scope to the default policy that the custom admin can access. [GP-1569]

- When using both *Citrix Studio* and *Web Studio* in your deployment, you might encounter: if you create an application folder in *Citrix Studio* but don't add any applications to it, that empty folder doesn't appear in *Web Studio*. [STUD-27526]
- While creating a hosting connection to Azure using the Web Studio, if you click **Create service principal** on the **Connection Details** page and click **Next**, you might get an error. To resolve the issue, allow third-party cookies in the browser. [STUD-24463]

VDA for single-session OS

- While using the Windows VDA, you might experience a keyboard mapping error when you switch from the Japanese to the Korean keyboard. [HDX-59307]
- The `SaveRsoptoFile`, `SaveRsoptoMemory`, and `SaveRsoptoRegistry` values under the `HKEY_LOCAL_MACHINE\SOFTWARE\Citrix\GroupPolicy` registry key might not be restored. [CVADHELP-23184]
- After you upgrade a VDA to version 2203, the Skype for Business app might become unresponsive at the splash screen. [CVADHELP-21021]
- `CSEngine.exe` is consuming more memory than expected on the VDA. [CVADHELP-19916]
- A deadlock in Broker Agent stops machines from re-registering on a DNS IP change. [CVADHELP-18952]
- This fix introduces a command-line option `/no_pending_reboot_check` that prevents checking for a pending restart from a previous Windows installation on the machine when installing or upgrading core components. [CVADHELP-21686]
- The `WebSocketService.exe` process fails to start after a VDA reboot. [CVADHELP-24771]

VDA for multi-session OS

- The `WebSocketService.exe` process might consume more memory than expected on the VDAs. [CVADHELP-23870]
- `CSEngine.exe` is consuming more memory than expected on the VDA. [CVADHELP-19916]
- A deadlock in Broker Agent stops machines from re-registering on a DNS IP change. [CVADHELP-18952]
- The `WebSocketService.exe` process fails to start after a VDA reboot. [CVADHELP-24771]

Profile Management

- [Profile Management 2402 LTSR documentation](#) provides specific information about the updates in this release.

Linux VDA

- [Linux VDA 2402 LTSR documentation](#) provides specific information about the updates in this release.

Session Recording

- [Session Recording 2402 LTSR documentation](#) provides specific information about the updates in this release.

Workspace Environment Management

- [Workspace Environment Management 2402 LTSR documentation](#) provides specific information about the updates in this release.

Citrix Provisioning

- [Citrix Provisioning 2402 LTSR documentation](#) provides specific information about the updates in this release.

Federated Authentication Service

- [Federated Authentication Service 2402 LTSR documentation](#) provides specific information about the updates in this release.

Known issues

April 16, 2024

Citrix Virtual Apps and Desktops 7 2402 LTSR includes the following known issues:

Notes

- If a known issue has a workaround, it is provided after the description of the issue.
- The following warning applies to any workaround that suggests changing a registry entry:

Warning:

Editing the registry incorrectly can cause serious problems that might require you to re-install your operating system. Citrix cannot guarantee that problems resulting from the incorrect use of the Registry Editor can be solved. Use the Registry Editor at your own risk. Be sure to back up the registry before you edit it.

General

- If you launch the app bar and then open the Connection Center menu in Citrix Workspace app for Windows, the app bar doesn't appear under the server that hosts it. [HDX-27504]
- If you use Citrix Workspace app for Windows and launch the app bar in a vertical position, the bar covers the Start menu or the system clock tray. [HDX-27505]
- The combo box might not display properly when a user selects a combo box that is already in focus on the host. As a workaround, select another UI element and then select the combo box. [HDX-21671]
- The Citrix Desktop Service might fail to start after performing an in-place OS upgrade from Windows 10 to Windows 11. To resolve the issue, restart the machine. [HDX-58399]
- The **Session limits** settings for multi-session VDAs are declined in session hosts running Windows Server 2022, Windows 10 Enterprise multi-session, and Windows 11 Enterprise multi-session.
As a workaround, you can configure **RDS Session Time Limits** through GPO. [HDX-47001]
- The Windows Security dialog box associated with FIDO2 will not be displayed in front of the ICA session window if you are running the application with administrator privileges. It is by the operating system design that the Windows Security dialog box will be hidden behind the ICA session window if it is running as an elevated process. [HDX-26794]
- Clipboard copy and paste may fail for data larger than 100MB from client to ICA session. Large buffer copies are not supported. [HDX-59028]
- Though a restore point is created, a VDA cannot be restored if a VDA installation failed on the Windows 10 or Windows 11 multi-session platform. The VDA installation was initiated through the UI or command line. [HDX-58915]
- Windows 10 or Windows 11 Multi-session OS does not support Windows System Restore. Hence, the option to create a restore point is unavailable in the UI. The command line options

`/EnableRestore` or `/EnableRestoreCleanup` are ignored and the **Disabling System Restore** as not currently supported on Windows 10/11 Multi Session OS's" message is logged. [HDX-58915]

- Citrix signs both Citrix-generated and third-party binaries. This means, the binaries are authenticated by Citrix. The versions of the third-party binaries remain the same as they are procured from third parties. If a binary is already installed, a VDA upgrade does not install the binaries because the versions match. To avoid this limitation:
 1. Include the binaries in an **allow list**. This eliminates the need for signing the binaries.
 2. Uninstall the older VDA and install the new VDA. This resembles a fresh VDA install and the signed versions are applied.

[HDX-62302]

- In some scenarios, when you use the Client IP policy filter, the IP address used to evaluate the policy is incorrect. [HDX-62375]
- When you use Enhanced domain pass-through for single sign-on, SSO into the session might fail if the client device or session host is running Windows 11. [HDX-62973]

Graphics

- If you start a video preview using a 64-bit webcam app over Theora compression, the session might crash. [HDX-21443]
- You might notice extra webcams that are connected to the remote desktop in the Skype for desktop app. These extra webcams' preview are blocked and might show a black screen due to security reasons. You can ignore the extra webcam and continue using the webcam for endpoint. [HDX-58807]
- H265 444 on Intel and some NVIDIA GPUs might result in artifacts being visible in the session. For issues related to Intel GPUs, there is a temporary workaround to resize the session or toggle fullscreen mode. [PMCS-41084]

Machine Creation Services

- In a VMware environment hosted on AWS, the MCS machine catalog creation fails if the master image is vTPM enabled. This issue affects all Citrix Virtual Apps and Desktops versions. For VMware support, see [Get Support](#). [PMCS-37603]

Printing

- Universal Print Server printers selected on the virtual desktop do not appear in the **Devices and Printers** window in the control panel. However, when users are working on applications, they can use those printers. This issue occurs only on Windows 10. For more information, see [CTX213540](#). [HDX-5043, 335153]
- The default printer might not be marked correctly in the printing dialog window. This issue does not affect print jobs sent to the default printer. [HDX-12755]
- Some print jobs from load-balanced network printers may fail when SSL connections to the Universal Print Servers are enabled. This happens when print jobs are fired rapidly one after the other. [HDX-58316]

Third-party issues

- Chrome supports UI Automation only for toolbars, tabs, menus, and buttons around a webpage. Because of this Chrome issue, the automatic keyboard display feature might not work in a Chrome browser on touch devices. As a workaround, run `chrome --force-renderer-accessibility` or you can open a new browser tab, type `chrome://accessibility`, and enable **Native accessibility API** support for specific or all pages. In addition, when you publish a seamless app, you can publish Chrome with the `--force-renderer-accessibility` switch. [HDX-20858]
- You may see a black screen when launching a session if you have FSLogix 2201 HF1 installed on the session host. To address this issue, you must upgrade FSLogix to a newer version. [HDX-46159]

Profile Management

- [Profile Management 2402 LTSR documentation](#) provides specific information about the updates in this release.

Linux VDA

- [Linux VDA 2402 LTSR documentation](#) provides specific information about the updates in this release.

Session Recording

- [Session Recording 2402 LTSR documentation](#) provides specific information about the updates in this release.

Workspace Environment Management

- [Workspace Environment Management 2402 LTSR documentation](#) provides specific information about the updates in this release.

Citrix Provisioning

- [Citrix Provisioning 2402 LTSR documentation](#) provides specific information about the updates in this release.

Federated Authentication Service

- [Federated Authentication Service 2402 LTSR documentation](#) provides specific information about the updates in this release.

Deprecation

April 16, 2024

The announcements in this article are intended to give you advanced notice of platforms, Citrix products, and features that are being phased out so that you can make timely business decisions. Citrix monitors customer use and feedback to determine when they are withdrawn. Announcements can change in subsequent releases and might not include every deprecated feature or functionality. For details about product lifecycle support, see the [Product Lifecycle Support Policy](#) article. For information about the Long Term Service Release (LTSR) servicing option, see <https://support.citrix.com/article/CTX205549>.

Deprecations and removals

The following table shows the platforms, Citrix products, and features that are deprecated or removed. Dates in **bold** face indicate changes at this release.

Deprecations

Deprecation means we intend to remove the feature or capability from a future release. The feature or capability will continue to work and is fully supported until it is officially removed. This deprecation notification can span a few months or years. After removal, the feature or capability will no longer work. This notice is to allow you sufficient time to plan and update your code before the feature or capability is removed. Alternatives for deprecated items are suggested where possible.

Item	Deprecation announced in version	Alternative
Support for Delivery Controller, Web Studio, Citrix Director, Citrix License Server, Citrix StoreFront, Server VDI for single-session OS, VDA for multi-session OS, Active Directory forest and domain, and Universal Print Server on Windows Server 2016	2402	Upgrade to the latest version of Windows Server.
Support for Microsoft SQL Server versions 2016 and 2017 for the site configuration, configuration logging, and monitoring databases	2402	Upgrade to the latest version of Microsoft SQL Server.
Support for configuring the write-back cache to include only a disk cache and no memory cache	2402	Use the memory cache size configuration option and allocate a non-zero size.
Support for Azure catalogs created before on-demand provisioning feature (“legacy” catalogs)	2402	Recreate Azure legacy catalog VMs. The catalogs are provisioned as on-demand and thereby, save storage cost.
The Target Minimum Frame Rate policy	2311	Use Graphics Status Indicator to modify the target minimum frame rate.
Support for Citrix Connector 3.1 for System Center Configuration Manager	2311	Do image or application update manually.

Item	Deprecation announced in version	Alternative
Support for using a master image in a region different from the region where the catalog is created	2311	Use Azure Compute Gallery to replicate the master image to the desired region.
HDX Graphics Display Memory Limit setting	2311	The minimum amount of memory required is allocated to ensure the client's display layout is fully accommodated.
Progressive mode support in HDX Graphics	2311	Use Thinwire. See Progressive mode .
Support for browser content redirection in Internet Explorer 11	2311	Use Google Chrome-based browser content redirection.
Removed the support for AWS volume worker	2311	Use Direct disk upload and download. See Direct disk upload and download .
Support for SQL Server 2016 in Broker	2308	Use the latest versions. For more information, see System Requirements .
Support for XenApp 5.x in Director	2308	—
Support for XenApp 6.x in Director	2308	—
SCOM Pack for alerts in Director	2308	—
Support for plug-in in Director	2308	—
Support for WebRTC SDP format (Plan B)	2308	Upgrade the Citrix Workspace App to a supported version.
Support for Single Window mode in Microsoft Teams Optimization	2308	Upgrade the Citrix Workspace App to a version that supports MultiWindow mode. For more information, see Feature matrix and version support .
Support for <code>AwsCaptureInstanceProperties</code> used in AWS environments	2308	Use a machine profile. See Create a catalog using a machine profile .

Item	Deprecation announced in version	Alternative
Schedule-ProvVMUpdate PowerShell command	2305	Use Set-ProvVMUpdateTimeWindow .
Request-ProvVMUpdate PowerShell command	2305	Use Set-ProvVMUpdateTimeWindow with -StartsNow and -DurationInMinutes -1 parameters.
Cancel-ProvVMUpdate PowerShell command	2305	Use Clear-ProvVMUpdateTimeWindow .
DedicatedTenancy parameter used in New-ProvScheme command	2303	Use TenancyType parameter.
License Server VPX	2206	—
Unmanaged disk to provision VMs in Azure environments.	2206	Use managed disks.
Host to Client (URL) redirection	2203	Bidirectional content redirection.
Support for four AWS specific commands: Revoke-HypSecurityGroupIngress , Revoke-HypSecurityGroupEgress , Grant-HypSecuritygroupegress , and Grant-HypSecurityGroupIngress used in Cloud and on-premises environment.	2203	—
Citrix Files for Windows and Citrix Files for Outlook from the VDA metainstaller.	2203	Use the standalone installers.

Item	Deprecation announced in version	Alternative
WEM Agent component from the VDA metainstaller.	2203	—
SCCM-integrated Wake on LAN option for Remote PC Access.	2012	Use the standalone Wake on LAN feature .
Citrix SCOM Management Packs for XenApp and XenDesktop, Provisioning Services, and StoreFront. For the product versions that can be monitored, see Citrix SCOM Management Packs documentation .	1912	Use Director for monitoring and managing your deployment. For more information on SCOM EOL and alternatives, see https://support.citrix.com/article/CTX266943 .
Mobility SDK / Mobile SDK (from the former Citrix Labs)	7.16	Superseded by mobile experience policy settings, and native experiences for hosted desktops/apps.

Removals

Removed items are either removed, or are no longer supported, in Citrix Virtual Apps and Desktops.

Item	Deprecation		Alternative
	announced in version	Removed in version	
Citrix Workspace app for Windows 1912	—	2402	Use the latest versions.
HDX Graphics FullScreen + Text optimization	2311	2311	
Support for NVIDIA Frame Buffer Capture (NVFBC) with HDX 3D Pro	2308	2311	Use Desktop Duplication API (DDAPI).

Item	Deprecation		Alternative
	announced in version	Removed in version	
VDA support for policy setting “Automatic installation of in-box printer drivers”.	7.16	2311	None. Policy setting supported with VDAs on earlier OSs only (Windows 7, Windows Server 2012 R2 and earlier).
NVIDIA GPU hardware encoding (NVENC) with: vGPU 11 and older, and driver version 466.77 and older.	2305	2305	Use currently supported NVIDIA drivers: vGPU 13 or newer, version 471.41 or newer.
Citrix Supportability Tools (Supportability-Tool_x64 .msi) from the VDA Meta-Installer.	—	2212	—
Citrix License Administration Console (last included in the Windows License Server 11.16.3 build 30000 and removed in the Windows License Server v11.16.6 build 31000).	2003	2006	Use the Citrix Licensing Manager.
Citrix Indirect Display Driver (IDD) graphics adapter support on Windows 10 version 1709 and earlier.	2003	2003	Use Citrix Virtual Apps and Desktops 7 1912 LTSR VDAs.

Item	Deprecation		Alternative
	announced in version	Removed in version	
Hardware encoding with NVIDIA GPUs (NVENC) using GRID 9 or earlier display drivers.	2003	2003	Use GRID 10 display drivers with Citrix Virtual Apps and Desktops 7 2003 or later VDAs, or use Citrix Virtual Apps and Desktops 7 1912 LTSR VDAs.
Self-Service Password Reset (SSPR) feature.	2003	2006	—
Support for Microsoft .NET Framework versions prior to version 4.8 for VDAs and core server components. Includes Delivery Controller, Studio, Director, and StoreFront.	1912	2003	Upgrade to .NET Framework version 4.8.
VDAs on Windows Server 2012 R2.	1912	2003	Install VDAs on a supported operating system.
AppDNA application migration component of Citrix Virtual Apps and Desktops Premium edition.	1909	2003	—
Installing Studio on 32-bit (x86) machines.	1909	2003	Install on a supported x64 operating system.
Support for the Excel hook in seamless applications. This was used for creating separate taskbar icons for each Microsoft Excel 2010 workbook.	1909	1909	—

Item	Deprecation		Alternative
	announced in version	Removed in version	
Core server components on Windows Server 2012 R2 (including Service Packs). Includes: Delivery Controller, Studio, and Director.	1906	2003	Install on a newer supported operating system.
Support for Site Configuration, Configuration Logging, and Monitoring databases on Microsoft SQL Server versions 2008 R2, 2012, and 2014 (including all Service Packs and editions).	1906	2003	Install databases on a supported Microsoft SQL Server version.
Support for VDAs on Windows 10 on x86 platforms.	1906	1909*	Install VDAs on a supported x64 operating system. *This feature is still supported in Citrix Virtual Apps and Desktops 7 1912 LTSR.
Removal of Citrix Smart Tools Agent from Citrix Virtual Apps and Desktops installation media.	1903	1906	—
Removal of Delivery Controller options for the following end-of-life products within StoreFront: VDI-in-a-Box, and XenMobile (9.0 and earlier).	1903	1903	—

Item	Deprecation		Alternative
	announced in version	Removed in version	
Support for Linux VDA on Red Hat Enterprise Linux/CentOS 7.5.	1903	1903	Install Linux VDA on a later version of Red Hat Enterprise Linux.
StoreFront support for TLS 1.0, and TLS 1.1 protocols between Citrix Virtual Apps and Desktops (formerly XenApp and XenDesktop) and Citrix Receiver, and Workspace Hub.	7.17	2203	Upgrade Citrix Receivers to a Citrix Workspace app that supports the TLS 1.2 protocol. For more information on Citrix Workspace app, see https://docs.citrix.com/en-us/citrix-workspace-app .
VDA support for policy setting “Automatic installation of in-box printer drivers”.	7.16	2311	None. Policy setting supported with VDAs on earlier OSs only (Windows 7, Windows Server 2012 R2 and earlier).
StoreFront support for users to access desktops on Desktop Appliance sites	1811	1912	Use Desktop Lock for nondomain-joined use cases.
Support for Framehawk display remoting technology	1811	1903	Use Thinwire with adaptive transport enabled.
Support for Citrix Smart Scale in all Citrix Virtual Apps and Desktops (and XenApp and XenDesktop) versions. This functionality will reach End of Life on 31 May 2019.	1808	1906	Consider using the Virtual Apps and Desktops Service on Citrix Cloud for improved power management functionality.

Item	Deprecation		Alternative
	announced in version	Removed in version	
Support for Microsoft .NET Framework versions 4.5.1, 4.5.2, 4.6, 4.6.1, 4.6.2, and 4.7 by Citrix StoreFront, Citrix VDAs, Citrix Studio, Citrix Director, and Citrix Delivery Controller.	7.18	1808	Upgrade to .NET Framework version 4.7.1 or later. (The installer automatically installs .NET Framework 4.7.1 if it is not already installed.)
Support for Linux VDA on Red Hat Enterprise Linux 7.3.	7.18	1808	Install Linux VDA on a later version of Red Hat Enterprise Linux.
Support for the Linux VDA on SUSE Linux Enterprise Server 11 Service Pack 4.	7.16	7.16	Install Linux VDA on supported SUSE version.
Support for Citrix WDDM driver on VDAs	7.16	7.16	The Citrix WDDM driver is no longer installed with VDAs.
VDAs on Windows 10 version 1511 (Threshold 2) and earlier Windows Single-session OS releases, including Windows 8.x and Windows 7 (see https://www.citrix.com/blogs/2018/01/08/the-citrix-strategy-for-windows-7-virtual-desktop-users/).	7.15 LTSR (and 7.12)	7.16	Install Single-session OS VDAs on Windows 10 minimum version 1607 (Redstone 1) or newer Semi-Annual Channels. If using 1607 LTSB, we recommend a 7.15 VDA. See CTX224843 .
VDAs on Windows Server 2008 R2 and Windows Server 2012 (including Service Packs)	7.15 LTSR (and 7.12)	7.16	Install VDAs on a supported operating system.

Item	Deprecation		Alternative
	announced in version	Removed in version	
Desktop Composition Redirection (previously known as DirectX Command Remoting) (DCR)	7.15 LTSR	7.16	Use Thinwire .
Citrix Receiver for Web classic experience (“green bubbles” user interface)	7.15 LTSR (and StoreFront 3.12)	1903	Citrix Receiver for Web unified experience.
Core components on Windows Server 2012 and Windows Server 2008 R2 (including Service Packs). Includes: Delivery Controller, Studio, Director, StoreFront, License Server, and Universal Print Server.	7.15 LTSR	7.18	Install components on a supported operating system.
Self-Service Password Reset (SSPR) feature on Windows Server 2012 and Windows Server 2008 R2 (including Service Packs)	7.15 LTSR	7.18	Install on a newer supported operating system.
Studio on Windows 7, Windows 8, and Windows 8.1 (including Service Packs)	7.15 LTSR	7.18	Install Studio on a supported operating system.

Item	Deprecation		Alternative
	announced in version	Removed in version	
Flash Redirection	7.15 LTSR	1912	Create video content as HTML5 Video. Use HTML5 Video Redirection for managed content, and Browser Content Redirection for public websites. For more information, see the Flash Redirection End of Life note.
Citrix Online Integration (Goto product) with StoreFront	7.14 (and StoreFront 3.11)	StoreFront 3.12	—
The user account, CtxAppVCOMAdmin, which was created during VDA installation and added to the Local Administrators Group on the VDA machine, is no longer created. The underlying “COM” mechanism is also removed.	7.14	7.14	The Windows service CtxAppVService performs the same function. It is automatically installed and configured and requires no user interaction.
Universal Print Server UpsServer component support on Windows Server 2008 32-bit	7.14	7.14	Install on a newer supported operating system.
StoreFront and Receiver for Web on Internet Explorer 8	7.13	7.13	—

Item	Deprecation		Alternative
	announced in version	Removed in version	
VDA command line installation option /no_appv to prevent installation of the Citrix App-V components	7.13	7.13	Use the command line installation option /exclude "Citrix Personalization for App-V –VDA".
The full-product installer no longer installs the Citrix.Common.Commands snap-in on new installations and automatically removes it when upgrading existing installations.	7.13	7.13	Some PowerShell commands that were provided by the Citrix.Common.Commands snap-in are still available in the XenApp 6.5 SDK.
Partial functionality to manipulate icon data that was provided by *-CtxIcon cmdlets.	7.13	7.13	Now provided by *-BrokerIcon cmdlets in the Broker Service.
Legacy Thinwire mode	7.12	7.16	Use Thinwire . If you are using Legacy Thinwire mode on Windows Server 2008 R2, migrate to Windows Server 2012 R2 or Windows Server 2016, and use Thinwire.
In-place upgrades from StoreFront 2.0, 2.1, 2.5, and 2.5.2	7.13	7.16	Upgrade from one of these versions to a later supported version and then to XenApp and XenDesktop 7.16.

Item	Deprecation		Alternative
	announced in version	Removed in version	
In-place upgrades from XenDesktop 5.6 or 5.6 FP1	7.12	7.16	Migrate your XenDesktop 5.6 or 5.6 FP1 deployment to the current XenDesktop version. To do this, first upgrade to XenDesktop 7.6 LTSR (with the latest CU), then upgrade to the latest Citrix Virtual Desktops (formerly XenDesktop) release or LTSR version.
Installing Delivery Controller, Director, StoreFront, or License Server on 32-bit (x86) machines.	7.12	7.16	Install on a supported x64 operating system.
Connection leasing	7.12	7.16	Use Local Host Cache .
XenDesktop 5.6 used on Windows XP. VDA installations on Windows XP are not supported.	7.12	7.16	Install VDAs on a supported operating system.
Support for CloudPlatform connections	7.12	2003	Use a different supported hypervisor or cloud service.
Support for Azure Classic (also known as Azure Service Management) connections	7.12	2003	Consider using the Virtual Apps and Desktops Service on Citrix Cloud.
AppDisks functionality (and the AppDNA integration into Studio, which supports it)	7.13	2003	Use Citrix App Layering.

Item	Deprecation		Alternative
	announced in version	Removed in version	
Personal vDisk functionality	7.15	2006†	Use Citrix App Layering user layer or user personalization layer technology.

† At Citrix Virtual Apps and Desktops 7 2003, the Personal vDisk driver was removed from the VDA installer. At Citrix Virtual Apps and Desktops 7 2006, the Personal vDisk driver workflow was removed from Studio.

System requirements

February 12, 2024

Introduction

The system requirements in this document were valid when this product version was released. Updates are made periodically. System requirements for components not covered here (such as host systems, Citrix Workspace app, and Citrix Provisioning) are described in their respective documentation.

Review [Prepare to install](#) before beginning an installation.

Except where noted, the component installer deploys software prerequisites automatically (such as .NET and C++ packages) if the required versions are not detected on the machine. The Citrix installation media also contains some of this prerequisite software.

The installation media contains several third-party components. Before using the Citrix software, check for security updates from the third party, and install them.

For globalization information, see Knowledge Center article [CTX119253](#).

For components and features that can be installed on Windows Servers, Nano Server installations are not supported, unless noted. Server Core is supported only for Delivery Controllers and Director.

Hardware requirements

RAM and disk space values are in addition to requirements for the product image, operating system, and other software on the machine. Your performance varies, depending on your configuration. Your

configuration includes the features that you use, plus the number of users, and other factors. Using only the minimum can result in slow performance.

The following table lists the minimum requirements for core components.

Component	Minimum
All core components and StoreFront on one server, for an evaluation only, not a production deployment	5 GB RAM
All core components and StoreFront on one server, for a test deployment or a small production environment	12 GB RAM
Delivery Controller (more disk space required for Local Host Cache)	5 GB RAM, 800 MB hard disk, database: see Sizing guidance
Studio	1 GB RAM, 100 MB hard disk
Director	2 GB RAM, 200 MB hard disk
StoreFront	2 GB RAM, see the StoreFront documentation for disk recommendations
License Server	2 GB RAM; see the Licensing documentation for disk recommendations

Sizing of VMs that deliver desktops and applications

Specific recommendations cannot be provided because of the complex and dynamic nature of hardware offerings, and every deployment has unique needs. Generally, sizing a Citrix Virtual Apps VM is based on the hardware and not the user workloads. The exception is RAM. You need more RAM for applications that consume more.

For more information:

- [Citrix Tech Zone](#) contains guidance on sizing.
- [Citrix Virtual Apps and Desktops Single Server Scalability](#) discusses how many users or VMs can be supported on a single physical host.

Microsoft Visual C++

When installing a Delivery Controller, Virtual Delivery Agent (VDA), or Universal Print Server, the Citrix installer automatically installs the Microsoft Visual C++ 2015–2022 Redistributable.

- If the machine contains an earlier version of that runtime (such as 2015-2019), the Citrix installer upgrades it.
- If the machine contains a version earlier than 2015, Citrix installs the newer version in parallel.

Delivery Controller

Supported operating systems:

- Windows Server Core 2022
- Windows Server 2022
- Windows Server 2019, Standard and Datacenter Editions, and with the Server Core option
- Windows Server 2016, Standard and Datacenter Editions, and with the Server Core option

Requirements:

- Microsoft .NET Framework 4.8 is installed automatically if it (or a later version) is not already installed.
- Windows PowerShell 3.0, 4.0, or 5.0.
- Microsoft Visual C++ 2015–2019 Redistributable.

Databases

Supported Microsoft SQL Server versions for the site configuration, configuration logging, and monitoring databases:

- SQL Server 2022, Express, Standard, and Enterprise Editions.
- SQL Server 2019, Express, Standard, and Enterprise Editions.
- SQL Server 2017, Express, Standard, and Enterprise Editions.
 - For new installations: By default, SQL Server Express 2017 with Cumulative Update 16 is installed when installing the Controller, if an existing supported SQL Server installation is not detected.
 - For upgrades, any existing SQL Server Express version is not upgraded.
- SQL Server 2016 SP2, Express, Standard, and Enterprise Editions.

The following database high availability solutions are supported (except for SQL Server Express, which supports only standalone mode):

- SQL Server AlwaysOn Failover Cluster Instances
- SQL Server AlwaysOn Availability Groups (including Basic Availability Groups)
- SQL Server Database Mirroring

Windows authentication is required for connections between the Controller and the SQL Server site database.

Local Host Cache considerations: Microsoft SQL Server Express LocalDB is a feature of SQL Server Express that Local Host Cache uses on a standalone basis. Local Host Cache does not require any components of SQL Server Express other than SQL Server Express LocalDB.

- When installing a Controller, Microsoft SQL Server Express LocalDB 2019 with Cumulative Update 15 is installed for use with the Local Host Cache feature. (This installation is separate from the default SQL Server Express installation for the site database.)
- When upgrading a Controller, the existing Microsoft SQL Server Express LocalDB version is not automatically upgraded. For replacement requirements and procedures, see [Replace SQL Server Express LocalDB](#).

More database information:

- [Databases](#)
- [CTX114501](#) lists the most currently supported databases
- [Database sizing guidance](#)
- [Local Host Cache](#)

Web Studio

Note:

- You can manage your Citrix Virtual Apps and Desktops deployment using two management consoles: Web Studio (web-based) and Citrix Studio (Windows-based). This article covers only Web Studio. For information about Citrix Studio, see the equivalent article in Citrix Virtual Apps and Desktops 7 2212 or earlier.
- Web Studio is a web-based management console that lets you configure and manage your on-premises Citrix Virtual Apps and Desktops deployment. It's designed for an improved user experience and generally responds faster than Citrix Studio, the Windows-based management console. See [Install Web Studio](#).

Supported operating systems:

- Windows Server Core 2022
- Windows Server 2022
- Windows Server 2019, Standard and Datacenter Editions, and with the Server Core option
- Windows Server 2016, Standard and Datacenter Editions, and with the Server Core option

Citrix Director

Supported operating systems:

- Windows Server Core 2022
- Windows Server 2022
- Windows Server 2019, Standard and Datacenter Editions, and with the Server Core option
- Windows Server 2016, Standard and Datacenter Editions, and with the Server Core option

Requirements:

- Microsoft .NET Framework 4.8 is installed automatically if it (or a later version) is not already installed.
- Microsoft Internet Information Services (IIS) 7.0 and ASP.NET 2.0. Ensure that the IIS server role has the Static Content role service installed. If this software is not already installed, you are prompted for the Windows Server installation media. Then, that software is installed for you.
- To view the event logs on machines where Citrix Director is installed, you must install Microsoft .NET Framework 2.0.

Citrix Profile Management:

- Ensure that the Citrix Profile Management and Citrix Profile Management WMI Plug-in are installed on the VDA (**Additional Components** page in the installation wizard) and that the Citrix Profile Management Service is running to view the user profile details in Director.

System Center Operations Manager (SCOM) integration requirements:

- System Center 2012 R2 Operations Manager

Supported browsers for viewing Director:

- Internet Explorer 11. Compatibility mode is not supported for Internet Explorer. Use the recommended browser settings to access Director. When you install Internet Explorer, accept the default to use the recommended security and compatibility settings. If you already installed the browser and chose not to use the recommended settings, go to **Tools > Internet Options > Advanced > Reset** and follow the instructions.
- Microsoft Edge.
- Firefox ESR (Extended Support Release).
- Chrome.

The recommended optimal screen resolution for viewing Director is 1440 x 1024.

Virtual Delivery Agent (VDA) for single-session OS

Supported operating systems:

- Windows 11
- Windows 10 (x64 only), any version that is currently in mainstream support.
 - For edition support, see Knowledge Center article [CTX224843](#).

Requirements:

- Microsoft .NET Framework 4.8 is installed automatically if it (or a later version) is not already installed.
- Microsoft Visual C++ 2015–2019 Redistributable.

Remote PC Access uses this VDA, which you install on physical office PCs. This VDA supports Secure Boot for Citrix Virtual Desktops Remote PC Access on Windows 11 and Windows 10.

Several multimedia acceleration features (such as HDX MediaStream Windows Media Redirection) require that Microsoft Media Foundation be installed on the machine on which you install the VDA. If the machine does not have Media Foundation installed, the multimedia acceleration features are not installed and do not work. Do not remove Media Foundation from the machine after installing the Citrix software. Otherwise, users cannot log on to the machine. On most supported Windows single-session OS editions, Media Foundation support is already installed and cannot be removed. However, N editions do not include certain media-related technologies; you can obtain that software from Microsoft or a third party. For more information, see [Prepare to install](#).

For Linux VDA information, see the [Linux Virtual Delivery Agent](#) articles.

To use the Server VDI feature, you can use the command-line interface to install a VDA for Windows single-session OS on a supported Windows Server machine. See [Server VDI](#) for guidance.

For information about installing a VDA on a Windows 7 machine, see [Earlier operating systems](#).

Virtual Delivery Agent (VDA) for multi-session OS

Supported operating systems:

- Windows 11 (supported only with Citrix DaaS)
- Windows 10 (x64 only; supported only with Citrix DaaS), any version that is currently in mainstream support.
- Windows Server 2022
- Windows Server 2019, Standard, and Datacenter Editions
- Windows Server 2016, Standard, and Datacenter Editions

The installer automatically deploys the following requirements, which are also available on the Citrix installation media in the **Support** folders:

- Microsoft .NET Framework 4.8 is installed automatically if it (or a later version) is not already installed.
- Microsoft Visual C++ 2015–2019 Redistributable.

The installer automatically installs and enables Remote Desktop Services role services, if they are not already installed and enabled.

Several multimedia acceleration features (such as HDX MediaStream Windows Media Redirection) require that the Microsoft Media Foundation be installed on the machine on which you install the VDA. If the machine does not have Media Foundation installed, the multimedia acceleration features are not installed and do not work. Do not remove Media Foundation from the machine after installing the Citrix software; otherwise, users will not be able to log on to the machine. On most Windows Server versions, the Media Foundation feature is installed through the Server Manager. For more information, see [Prepare to install](#).

If the Media Foundation is not present on the VDA, these multimedia features do not work:

- Windows Media Redirection
- HTML5 Video Redirection
- HDX RealTime Webcam Redirection

For Linux VDA information, see the [Linux Virtual Delivery Agent](#) articles.

For information about installing a VDA on a Windows Server 2008 R2 machine, see [Earlier operating systems](#).

Hosts / virtualization resources

The following host/virtualization resources (listed alphabetically) are supported. Where applicable, the *major.minor* versions are supported, including updates to those versions. Knowledge Center article [CTX131239](#) contains current version information, plus links to known issues.

Some features might not be supported on all host platforms or all platform versions. See the feature documentation for details.

The Remote PC Access Wake on LAN feature requires Microsoft System Center Configuration Manager minimum 2012.

Supported hypervisors:

- **XenServer (formerly Citrix Hypervisor)**

[CTX131239](#) contains current version information, plus links to known issues.

For more information, see [XenServer virtualization environments](#).

- **Microsoft System Center Virtual Machine Manager**

Includes any version of Hyper-V that can register with the supported System Center Virtual Machine Manager versions.

[CTX131239](#) contains current version information, plus links to known issues.

For more information, see [Microsoft System Center Virtual Machine Manager virtualization environments](#).

- **Nutanix Acropolis**

[CTX131239](#) contains current version information, plus links to known issues.

For more information, see [Nutanix virtualization environments](#).

- **VMware vSphere (vCenter + ESXi)**

No support is provided for vSphere vCenter Linked Mode operation.

[CTX131239](#) contains current version information, plus links to known issues.

For more information, see [VMware virtualization environments](#).

Supported public cloud hosts:

- **Amazon Web Services (AWS)**

For information about using AWS to provision virtual machines, see [Amazon Web Services virtualization environments](#).

- **Google Cloud Platform**

For more information, see [Google Cloud Platform virtualization environments](#) and [Getting Started with Citrix DaaS on Google Cloud](#).

- **Microsoft Azure Resource Manager**

For information about using Microsoft Azure Resource Manager to provision virtual machines, see [Microsoft Azure Resource Manager virtualization environments](#).

- **Nutanix cloud and partner solutions**

For information about using Nutanix cloud and partner solutions, see [Nutanix cloud and partner solutions](#).

- **VMware cloud and partner solutions**

For information about using VMware cloud and partner solutions, see [VMware cloud and partner solutions](#).

When adding public cloud host connections to your deployment, consider the following:

- You need Hybrid Rights License. For information about Hybrid Rights License, see [Transition and Trade-Up \(TTU\) with Hybrid Rights](#). For information about adding a license, see [Create a site](#).
- The information sources direct you to the Citrix DaaS documentation. If you are familiar with the public cloud hosts in the Citrix DaaS product, the on-premises version has several differences.
 - In Citrix DaaS, the management interface is known as Full Configuration. In on-premises Citrix Virtual Apps and Desktops, the management interface is known as Web Studio.
 - Updates are rolled out to Citrix DaaS approximately every four weeks. So, you might find that certain features available with Citrix DaaS are not available with the on-premises version.

Active Directory functional levels

The following functional levels for the Active Directory forest and domain are supported:

- Windows Server 2016
- Windows Server 2012
- Windows Server 2008 R2
- Windows Server 2008

HDX

Audio

UDP audio for Multi-Stream ICA is supported on Citrix Workspace app for Windows and Citrix Workspace app for Linux 13.

Echo cancellation is supported on Citrix Workspace app for Windows.

See the specific HDX feature support and requirements. For more information on HDX features and Citrix Workspace apps, see the [Feature matrix](#).

HDX Windows Media delivery

The following clients are supported for Windows Media client-side content fetching, Windows Media redirection, and real-time Windows Media multimedia transcoding: Citrix Workspace app for Windows, Citrix Workspace app for iOS, and Citrix Workspace app for Linux.

To use Windows Media client-side content fetching on Windows 8 devices, set the Citrix Multimedia Redirector as a default program: in **Control Panel > Programs > Default Programs > Set your default programs**, select **Citrix Multimedia Redirector** and click either **Set this program as default**

or **Choose defaults for this program**. GPU transcoding requires an NVIDIA CUDA-enabled GPU with Compute Capability 1.1 or higher; see <https://developer.nvidia.com/cuda/cuda-gpus>.

HDX 3D Pro

The VDA for Windows single-session OS detects the presence of GPU hardware at runtime.

The physical or virtual machine hosting the application can use GPU Passthrough or Virtual GPU (vGPU):

- GPU Passthrough is available with:
 - XenServer
 - Nutanix AHV
 - VMware vSphere and VMware ESX, where it is referred to as virtual Direct Graphics Acceleration (vDGA)
 - Microsoft Hyper-V in Windows Server 2016 where it is referred to as Discrete Device Assignment (DDA).
- vGPU is available with:
 - XenServer
 - Nutanix AHV
 - VMware vSphere

See <https://docs.citrix.com/en-us/citrix-virtual-apps-desktops/graphics/hdx-3d-pro>.

Citrix recommends that the host computer has at least 4 GB of RAM and four virtual CPUs with a clock speed of 2.3 GHz or higher.

Graphical Processing Unit (GPU):

- For virtualized graphics acceleration using the NVIDIA GRID API, you can use HDX 3D Pro with all the NVIDIA GRID GPUs supported by the NVIDIA Virtual GPU (vGPU) software version 13 and up, see <https://docs.nvidia.com/grid/index.html>.
For a detailed list of supported Hypervisors and supported hardware, see the [NVIDIA vGPU software](#) documentation.
- Virtualized graphics acceleration is supported on the Intel Xeon Processor E3 Family of data center graphics platforms and the Intel data center GPU Flex series. For more information, see [GPU Flex series](#).
- AMD GPUs are supported with AMD's mxGPU virtualization. For more information on supported hardware, see [AMD documentation](#).

User device:

- Citrix supports up to 8 4k monitors, depending on the hardware resources. Depending on the GPU used, there can be other hardware restrictions on this maximum.
- Citrix recommends that user devices have at least 4 GB of RAM and a CPU with a clock speed of 1.6 GHz or higher. For optimum performance, we recommend that user devices have at least 8 GB of RAM and a dual-core CPU with a clock speed of 3 GHz or higher.
- For multi-monitor access, Citrix recommends user devices with quad-core CPUs.
- Citrix Workspace app must be installed.

For more information, see the [HDX 3D Pro articles](#) and www.citrix.com/xenapp/3d.

Universal Print Server

The Universal Print Server comprises client and server components. The UpsClient component is included in the VDA installation. You install the UpsServer component on each print server where shared printers reside that you want to provision with the Citrix Universal Print Driver in user sessions.

The UpsServer component is supported on:

- Windows Server 2022
- Windows Server 2019
- Windows Server 2016

Requirements:

- Microsoft Visual C++ 2015–2019 Redistributable
- Microsoft .NET Framework 4.8 (minimum)

For VDAs for Multi-session OS, user authentication during printing operations requires the Universal Print Server to be joined to the same domain as the VDA.

Standalone client and server component packages are also available for download.

For more information, see [Provision printers](#).

Other

Only Citrix License Server 11.17.2 and later are supported. For more information, see [Licensing](#).

See the [Product Matrix](#) for more information about version compatibility.

For supported StoreFront versions, see the [StoreFront system requirements](#).

The Microsoft Group Policy Management Console (GPMC) is required if you store Citrix policy information in Active Directory rather than the site configuration database. If you install `CitrixGroupPolicyManagement_x64.msi` separately (for example, on a machine that does

not have a Citrix Virtual Apps and Desktops core component installed), that machine must have Visual Studio 2015 runtime installed. For more information, see the Microsoft documentation.

If you want to edit domain GPOs using GPMC, enable the Group Policy Management feature (in the Windows Server Manager) on all machines containing Delivery Controllers.

Multiple NICs are supported.

By default, the Citrix Workspace app for Windows is not installed when you install a current VDA. For more information, see the [Citrix Workspace app for Windows documentation](#).

See [Local App Access](#) for supported browser information for that feature.

This version of Citrix Virtual Apps and Desktops requires a minimum of HDX RealTime Connector 2.9 LTSR. For more information, see [the HDX RealTime Optimization Pack documentation](#).

This product supports PowerShell versions 3 through 5.

Technical overview

March 14, 2024

Citrix Virtual Apps and Desktops are virtualization solutions that give IT control of virtual machines, applications, licensing, and security while providing anywhere access for any device.

Citrix Virtual Apps and Desktops allow:

- End users to run applications and desktops independently of the device's operating system and interface.
- Administrators to manage the network and control access from selected devices or from all devices.
- Administrators to manage an entire network from a single data center.

Citrix Virtual Apps and Desktops share a unified architecture called FlexCast Management Architecture (FMA). FMA's key features are the ability to run multiple versions of Citrix Virtual Apps or Citrix Virtual Desktops from a single site and integrated provisioning.

[Learn about product name changes.](#)

Key components

This article is most helpful if you're new to Citrix Virtual Apps and Desktops.

This illustration shows the key components in a typical deployment, which is called a site.

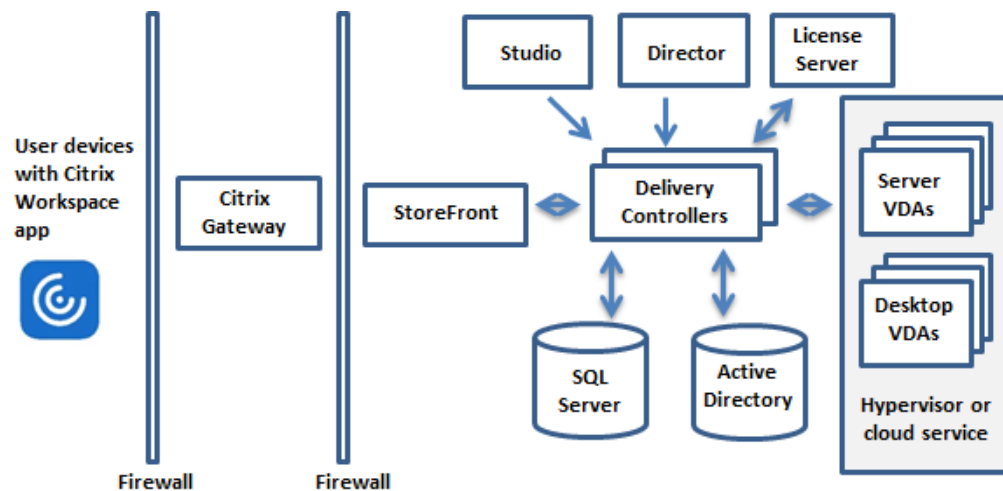

Delivery Controller

The Delivery Controller is the central management component of a site. Each site has one or more Delivery Controllers. It is installed on at least one server in the data center. For site reliability and availability, install Controllers on more than one server. If your deployment includes a hypervisor or other service, the Controller services communicate with it to:

- Distribute applications and desktops
- Authenticate and manage user access
- Broker connections between users and their desktops and applications
- Optimize user connections
- Load balance the connections

The Controller's Broker Service tracks which users are logged on and where, what session resources the users have, and if users need to reconnect to existing applications. The Broker Service runs PowerShell cmdlets and communicates with a broker agent on the VDAs over TCP port 80. It does not have the option to use TCP port 443.

The Monitor Service collects historical data and places it in the monitoring database. This service uses TCP port 80 or 443.

Data from the Controller services is stored in the site database.

The Controller manages the state of desktops, starting and stopping them based on demand and administrative configuration.

Database

At least one Microsoft SQL Server database is required for every site to store configuration and session information. This database stores the data collected and managed by the services that make up the

Controller. Install the database within your data center, and ensure it has a persistent connection to the Controller.

The site also uses a configuration logging database and a monitoring database. By default, those databases are installed in the same location as the site database, but you can change this.

Virtual Delivery Agent (VDA)

The VDA is installed on each physical or virtual machine in your site that you make available to users. Those machines deliver applications or desktops. The VDA enables the machine to register with the Controller, which in turn allows the machine and the resources it is hosting to be made available to users. VDAs establish and manage the connection between the machine and the user device. VDAs also verify that a Citrix license is available for the user or session, and apply policies that are configured for the session.

The VDA communicates session information to the Broker Service in the Controller through the broker agent in the VDA. The broker agent hosts multiple plug-ins and collects real-time data. It communicates with the Controller over TCP port 80.

The word “VDA” is often used to refer to the agent and the machine on which it is installed.

VDAs are available for single-session and multi-session Windows operating systems. VDAs for multi-session Windows operating systems allow multiple users to connect to the server at a time. VDAs for single-session Windows operating systems allow only one user to connect to the desktop at a time. [Linux VDAs](#) are also available.

Citrix StoreFront

StoreFront authenticates users and manages stores of desktops and applications that users access. It can host your enterprise application store, which gives users self-service access to the desktops and applications that you make available to them. It also keeps track of users’ application subscriptions, shortcut names, and other data. This helps ensure that users have a consistent experience across multiple devices.

Citrix Workspace app

Installed on user devices and other endpoints (such as virtual desktops), Citrix Workspace app provides users with quick, secure, self-service access to documents, applications, and desktops. Citrix Workspace app provides on-demand access to Windows, web, and Software as a Service (SaaS) applications. For devices that can’t install the device-specific Citrix Workspace app software, Citrix Workspace app for HTML5 provides a connection through an HTML5-compatible web browser.

Studio

You can manage your Citrix Virtual Apps and Desktops deployment using two management consoles: Web Studio (web-based) and Citrix Studio (Windows-based). This product documentation covers only Web Studio. For information about Citrix Studio, see Citrix Virtual Apps and Desktops 7 2212 or earlier.

Web Studio Web Studio is a web-based management console that lets you configure and manage your on-premises Citrix Virtual Apps and Desktops deployment. It's designed for an improved user experience and generally responds faster than Citrix Studio, the Windows-based management console. See [Install Web Studio](#).

Citrix Studio Citrix Studio is the management console where you configure and manage your Citrix Virtual Apps and Desktops deployment. Citrix Studio eliminates the need for separate management consoles for managing delivery of applications and desktops. Citrix Studio provides wizards to guide you through environment setup, creating workloads to host applications and desktops, and assigning applications and desktops to users. You can also use Studio to allocate and track Citrix licenses for your site.

Citrix Studio gets the information it displays from the Broker Service in the Controller, communicating over TCP port 80.

Secure Private Access

Citrix Secure Private Access on-premises solution enhances an organization's overall security and compliance posture with the ability to easily deliver Zero Trust Network Access to browser-based apps (internal web apps and SaaS apps) using StoreFront as a unified access portal to web and SaaS apps, along with virtual apps and desktops as an integrated part of Citrix Workspace. The solution is compatible with existing releases of NetScaler and StoreFront without any changes to the versions. For details, see [Secure Private Access for on-premises](#).

Citrix Director

Director is a web-based tool that enables IT support and help desk teams to monitor an environment, troubleshoot issues before they become system-critical, and perform support tasks for end users. You can use one Director deployment to connect to and monitor multiple Citrix Virtual Apps or Citrix Virtual Desktops sites.

Director displays:

- Real-time session data from the Broker Service in the Controller, which includes data the Broker Service gets from the broker agent in the VDA.
- Historical site data from the Monitor Service in the Controller.

Director uses the ICA performance and heuristics data captured by the Citrix Gateway device to build analytics from the data and then presents it to the administrators.

You can also view and interact with a user's sessions through Director, using Windows Remote Assistance.

Citrix License Server

The License Server manages your Citrix product licenses. It communicates with the Controller to manage licensing for each user's session and with Studio to allocate license files. A site must have at least one license server to store and manage your license files.

Hypervisor or other service

The hypervisor or other service hosts the virtual machines in your site. These can be the VMs you use to host applications and desktops, and VMs you use to host the Citrix Virtual Apps and Desktops components. A hypervisor is installed on a host computer dedicated entirely to running the hypervisor and hosting virtual machines.

Citrix Virtual Apps and Desktops support various hypervisors and other services.

Although many deployments require a hypervisor, you don't need one to provide Remote PC Access. A hypervisor is also not required when you are using Provisioning Services (PVS) to provision VMs.

Additional components

The following components can also be included in Citrix Virtual Apps and Desktops deployments. For more information, see their documentation.

Citrix Provisioning

Citrix Provisioning (formerly Provisioning Services) is an optional component that is available with some editions. It provides an alternative to MCS for provisioning virtual machines. Whereas MCS creates copies of a master image, PVS streams the master image to user devices. PVS doesn't require a hypervisor to do this, so you can use it to host physical machines. PVS communicates with the Controller to provide users with resources.

Citrix Gateway

When users connect from outside the corporate firewall, Citrix Virtual Apps and Desktops can use Citrix Gateway (formerly Access Gateway and NetScaler Gateway) technology to secure these connections with TLS. The Citrix Gateway or VPX virtual appliance is an SSL VPN appliance that is deployed in the demilitarized zone (DMZ). It provides a single secure point of access through the corporate firewall.

Citrix SD-WAN

In deployments where virtual desktops are delivered to users at remote locations such as branch offices, Citrix SD-WAN technology can be employed to optimize performance. Repeaters accelerate performance across WANs. With repeaters in the network, users in the branch office experience LAN-like performance over the WAN. Citrix SD-WAN can prioritize different parts of the user experience so that, for example, the user experience does not degrade in the branch location when a large file or print job is sent over the network. HDX WAN optimization provides tokenized compression and data deduplication, dramatically reducing bandwidth requirements and improving performance.

How typical deployments work

A site is made up of machines with dedicated roles that allow for scalability, high availability, and failover, and provide a solution that is secure by design. A site consists of VDA-installed servers and desktop machines, and the Delivery Controller, which manages access.

Deployment Overview

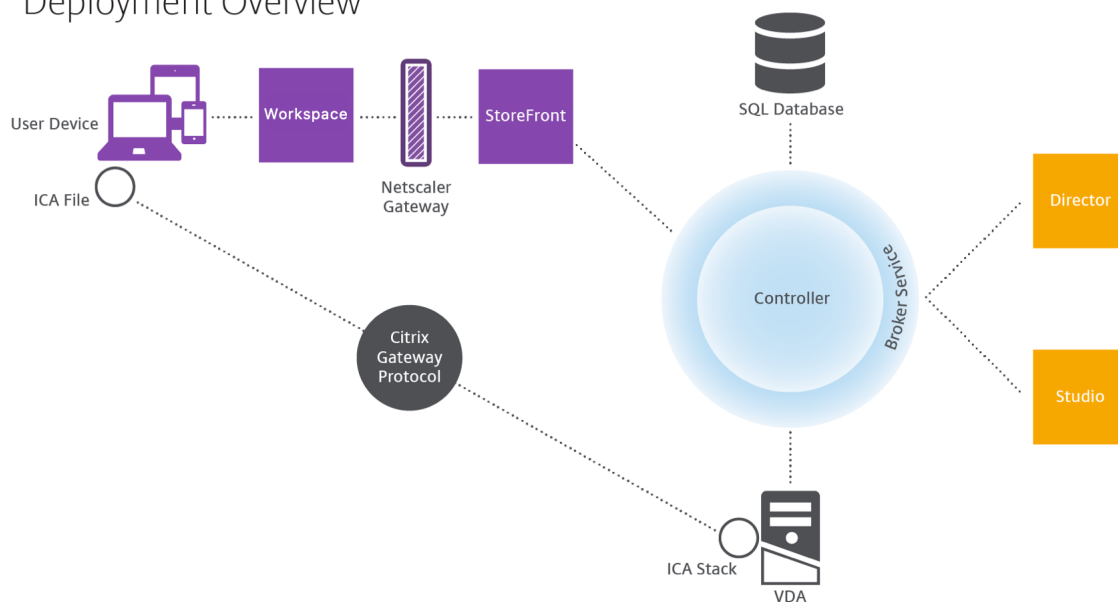

The VDA enables users to connect to desktops and applications. It is installed on virtual machines in the data center for most delivery methods, but it can also be installed on physical PCs for Remote PC Access.

The Controller is made up of independent Windows services that manage resources, applications, and desktops, and optimize and balance user connections. Each site has one or more Controllers. Because sessions are affected by latency, bandwidth, and network reliability, place all Controllers on the same LAN, if possible.

Users never directly access the Controller. The VDA serves as an intermediary between users and the Controller. When users log on using StoreFront, their credentials pass through to the Broker Service on the Controller. The Broker Service then obtains profiles and available resources based on the policies set for them.

How user connections are handled

To start a session, the user connects either through Citrix Workspace app installed on the user’s device, or a StoreFront website.

The user selects the physical or virtual desktop or virtual application that is needed.

The user’s credentials move through this pathway to access the Controller, which determines which resources are needed by communicating with a Broker Service. Citrix recommends that administrators place an SSL certificate on StoreFront to encrypt the credentials coming from Citrix Workspace app.

User connections

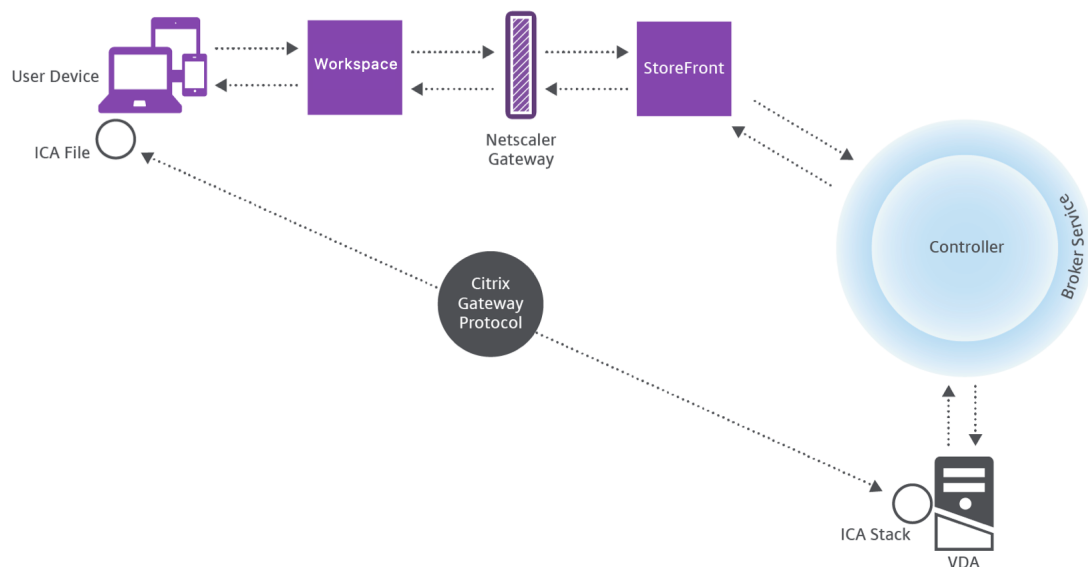

The Broker Service determines which desktops and applications the user is allowed to access.

After the credentials are verified, information about available applications or desktops is sent back to the user through the StoreFront-Citrix Workspace app pathway. When the user selects applications or desktops from this list, that information goes back down the pathway to the Controller. The Controller then determines the proper VDA to host the specific applications or desktop.

The Controller sends a message to the VDA with the user's credentials, and then sends all the data about the user and the connection to the VDA. The VDA accepts the connection and sends the information back through the same pathways to Citrix Workspace app. A set of required parameters is collected on StoreFront. These parameters are then sent to Citrix Workspace app either as part of the Citrix-Workspace-app-StoreFront protocol conversation, or converted to an Independent Computing Architecture (ICA) file and downloaded. As long as the site was properly set up, the credentials remain encrypted throughout this process.

The ICA file is copied to the user's device and establishes a direct connection between the device and the ICA stack running on the VDA. This connection bypasses the management infrastructure (Citrix Workspace app, StoreFront, and Controller).

The connection between Citrix Workspace app and the VDA uses the Citrix Gateway Protocol (CGP). If a connection is lost, the Session Reliability feature enables the user to reconnect to the VDA rather than having to relaunch through the management infrastructure. Session Reliability can be enabled or disabled in Citrix policies.

After the client connects to the VDA, the VDA notifies the Controller that the user is logged on. The Controller then sends this information to the site database and starts logging data in the monitoring database.

How data access works

Every Citrix Virtual Apps and Desktops session produces data that IT can access through Studio or Director. Using Studio, administrators can access real-time data from the Broker Agent to manage sites. Director accesses the same data plus historical data stored in the monitoring database. It also accesses HDX data from NetScaler Gateway for help desk support and troubleshooting.

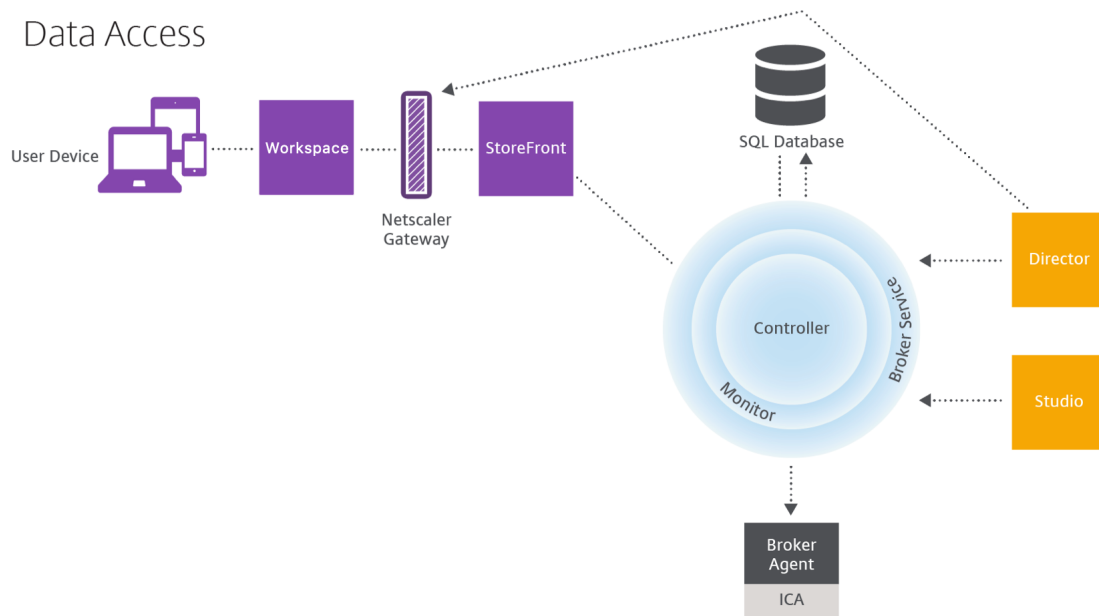

Within the Controller, the Broker Service reports session data for every session on the machine providing real-time data. The Monitor Service also tracks the real-time data and stores it as historical data in the monitoring database.

Studio communicates only with the Broker Service. It accesses only real-time data. Director communicates with the Broker Service (through a plug-in in the Broker Agent) to access the site database.

Director can also access Citrix Gateway to get information on the HDX data.

Deliver desktops and applications

You set up the machines that deliver applications and desktops with machine catalogs. Then, you create delivery groups that specify the applications and desktops that will be available (using machines in the catalogs), and which users can access them. Optionally, you can then create application groups to manage collections of applications.

Machine catalogs

Machine catalogs are collections of virtual or physical machines that you manage as a single entity. These machines, and the application or virtual desktops on them, are the resources you provide to your users. All the machines in a catalog have the same operating system and the same VDA installed. They also have the same applications or virtual desktops.

Typically, you create a master image and use it to create identical VMs in the catalog. For VMs you can specify the provisioning method for the machines in that catalog: Citrix tools (Citrix Provisioning

or MCS) or other tools. Alternatively, you can use your own existing images. In that case, you must manage target devices on an individual basis or collectively using third-party electronic software distribution (ESD) tools.

Valid machine types are:

- **Multi-session OS:** Virtual or physical machines with a multi-session operating system. Used for delivering Citrix Virtual Apps published apps (also known as server-based hosted applications) and Citrix Virtual Apps published desktops (also known as server-hosted desktops). These machines allow multiple users to connect to them at one time.
- **Single-session OS:** Virtual or physical machines with a single-session operating system. Used for delivering VDI desktops (desktops running single-session OSs that can optionally be personalized), VM hosted apps (applications from single-session OSs), and hosted physical desktops. Only one user at a time can connect to each of these desktops.
- **Remote PC Access:** Enables remote users to access their physical office PCs from any device running Citrix Workspace app. The office PCs are managed through the Citrix Virtual Desktops deployment, and require user devices to be specified in an allow list.

For more information, see [Citrix Virtual Apps and Desktops Image Management](#) and [Create machine catalogs](#).

Delivery groups

Delivery groups specify which users can access which applications, desktops, or both on which machines. Delivery groups contain machines from your machine catalogs, and Active Directory users who have access to your site. You might assign users to your delivery groups by their Active Directory group, because Active Directory groups and delivery groups are ways to group users with similar requirements.

Each delivery group can contain machines from more than one catalog, and each catalog can contribute machines to more than one delivery group. However, each individual machine can only belong to one delivery group at a time.

You define which resources users in the delivery group can access. For example, to deliver different applications to different users, you might install all the applications on the master image for one catalog and create enough machines in that catalog to distribute among several delivery groups. You can then configure each delivery group to deliver a different subset of applications that are installed on the machines.

For more information, see [Create delivery groups](#).

Application groups

Application groups provide application management and resource control advantages over using more delivery groups. Using the tag restriction feature, you can use your existing machines for more than one publishing task, saving the costs associated with deployment and managing more machines. A tag restriction can be thought of as subdividing (or partitioning) the machines in a delivery group. Application groups can also be helpful when isolating and troubleshooting a subset of machines in a delivery group.

For more information, see [Create application groups](#).

More information

- [Citrix Virtual Apps and Desktops diagrams](#)
- [Network ports](#)
- [Databases](#)
- [Supported hypervisors and other services](#)

Databases

March 24, 2023

Note:

You can manage your Citrix Virtual Apps and Desktops deployment using two management consoles: Web Studio (web-based) and Citrix Studio (Windows-based). This article covers only Web Studio. For information about Citrix Studio, see the equivalent article in Citrix Virtual Apps and Desktops 7 2212 or earlier.

A Citrix Virtual Apps or Citrix Virtual Desktops site uses three SQL Server databases:

- **Site:** (also known as site configuration) stores the running site configuration, plus the current session state and connection information.
- **Logging:** (also known as Configuration Logging) stores information about site configuration changes and administrative activities. This database is used when the configuring logging feature is enabled (default = enabled).
- **Monitoring:** stores data used by Director, such as session and connection information.

Each Delivery Controller communicates with the site database. Windows authentication is required between the Controller and the databases. A Controller can be unplugged or turned off without affecting other Controllers in the site. This means, however, that the site database forms a single point

of failure. If the database server fails, existing connections continue to function until a user either logs off or disconnects. For information about connection behavior when the site database becomes unavailable, see [Local Host Cache](#).

Citrix recommends the following regarding databases:

- **Back up regularly.** Back up the databases regularly so that you can restore from the backup if the database server fails. The backup strategy for each database can differ. For more information, see [CTX135207](#); note, however, that it refers to CitrixXenDesktopDB, which is no longer supported or available to customers.
- **Back up and restore the Site, Monitoring and Logging SQL Server databases regularly.** For specific information about SQL Server databases, see [Creating Full and Differential Backups of a SQL Server Database](#).

If your site contains more than one zone, ensure that the primary zone always contains the site database. Controllers in every zone communicate with that database.

High availability

There are several high availability solutions to consider for ensuring automatic failover:

- **AlwaysOn Availability Groups (including Basic Availability Groups):** This enterprise-level high availability and disaster recovery solution introduced in SQL Server 2012 enables you to maximize availability for one or more databases. AlwaysOn Availability Groups requires that the SQL Server instances reside on Windows Server Failover Clustering (WSFC) nodes. For more information, see [Windows Server Failover Clustering with SQL Server](#).
- **SQL Server database mirroring:** Mirroring the database ensures that, if you lose the active database server, an automatic failover process happens in a matter of seconds, so that users are generally unaffected. This method is more expensive than other solutions because full SQL Server licenses are required on each database server. You cannot use SQL Server Express edition in a mirrored environment.
- **SQL clustering:** The Microsoft SQL clustering technology can be used to automatically allow one server to take over the tasks and responsibilities of another server that has failed. However, setting up this solution is more complicated, and the automatic failover process is typically slower than alternatives such as SQL mirroring.
- **Using the hypervisor's high availability features:** With this method, you deploy the database as a virtual machine and use your hypervisor's high availability features. This solution is less expensive than mirroring because it uses your existing hypervisor software and you can also use SQL Server Express edition. However, the automatic failover process is slower, as it can take time for a new machine to start for the database, which might interrupt the service to users.

The Local Host Cache feature supplements the SQL Server high availability best practices. Local Host Cache enables users to connect and reconnect to applications and desktops even when the site database is not available. For more information, see [Local Host Cache](#).

If all Controllers in a site fail, you can configure the VDAs to operate in high availability mode, which allows users to continue to access their desktops and applications. In high availability mode, the VDA accepts direct ICA connections from users, rather than connections brokered by the Controller. Use this feature only on the rare occasion when communication with all Controllers fails. The feature is not an alternative to other high availability solutions. For more information, see [CTX 127564](#).

Installing a Controller on a node in an SQL clustering or SQL mirroring installation is not supported.

Install database software

By default, SQL Server Express edition is installed when you install the first Delivery Controller if another SQL Server instance is not detected on that server. That default action is usually sufficient for proof of concept or pilot deployments. However, SQL Server Express does not support Microsoft high availability features.

The default installation uses the default Windows service accounts and permissions. See the Microsoft documentation for details of these defaults, including the addition of Windows service accounts to the sysadmin role. The Controller uses the Network Service account in this configuration. The Controller does not require any additional SQL Server roles or permissions.

If necessary, you can select **Hide instance** for the database instance. When configuring the address of the database in Web Studio, enter the instance's static port number, rather than its name. See the Microsoft documentation for details about hiding an instance of SQL Server Database Engine.

For most production deployments, and any deployment that uses Microsoft high availability features, we recommend using only supported non-Express editions of SQL Server. Install SQL Server on machines other than the server where the first Controller is installed. [System requirements](#) lists the supported SQL Server versions. The databases can reside on one or more machines.

Ensure the SQL Server software is installed before creating a site. You don't have to create the database, but if you do, it must be empty. Configuring Microsoft high availability technologies is also recommended.

Use Windows Update to keep SQL Server up-to-date.

Set up the databases from the site creation wizard

Specify the database names and addresses (location) on the **Databases** page in the site creation wizard. (See Database address formats.) To avoid potential errors when Director queries the Monitor Service, do not use whitespace in the name of the monitoring database.

The **Databases** page offers two options for setting up the databases: automatic and using scripts. Generally, you can use the automatic option if you (the Web Studio user and Citrix administrator) have the required database privileges. (See [Permissions required to set up databases](#).)

You can change the location of the configuration logging and monitoring database later, after you create the site. See [Change database locations](#).

To configure a site to use a mirror database, complete the following and then proceed with the automatic or scripted setup procedures.

1. Install the SQL Server software on two servers, A and B.
2. On Server A, create the database intended to be used as the principal. Back up the database on Server A and then copy it to server B.
3. On Server B, restore the backup file.
4. Start mirroring on server A.

To verify mirroring after creating the site, run the PowerShell cmdlet `get-configdbconnection` to ensure that the Failover Partner has been set in the connection string to the mirror.

If you later add, move, or remove a Delivery Controller in a mirrored database environment, see [Delivery Controllers](#).

Automatic setup

If you have the required database privileges, select **Create and set up databases from Studio** on the **Databases** page of the site creation wizard. Then provide the names and addresses of the principal databases.

If a database exists at an address you specify, it must be empty. If databases don't exist at a specified address, you are informed that a database cannot be found, and then asked if you want the database to be created for you. When you confirm that action, Web Studio automatically creates the databases, and then applies the initialization scripts for the principal and replica databases.

Scripted setup

If you do not have the required database rights, request assistance from someone who does, such as a database administrator. Here is the sequence:

1. On the **Databases** page in the site creation wizard, select **Generate scripts to manually set up**. This action generates the following three types of scripts for each of the following principal and the replica databases: site, monitoring, and logging databases.
 - *Script containing "SysAdmin" in its name.* A script that creates the databases and the Delivery Controller login. These tasks require securityadmin rights.

- *Script containing “DbOwner” in its name.* A script that creates the user roles in the database, adds the logins, and then creates the database schemas. These tasks require `db_owner` rights.
- *Script containing “Mixed” in its name.* All tasks in one script, regardless of required rights.

You can indicate where to store the scripts.

Note:

In enterprise environments, database setup includes scripts that might be handled by different teams with different roles (rights): `securityadmin` or `db_owner`. If applicable, you first have “SysAdmin” scripts run by administrators with the `securityadmin` role and then “DbOwner” scripts run by administrators with `db_owner` rights. To generate those scripts, you can also use PowerShell. For details, see [Preferred database rights scripts](#).

2. Give those scripts to your database administrator. The site creation wizard stops automatically at this point. You are prompted when you return later to continue the site creation.

The database administrator then creates the databases. Each database must have the following characteristics:

- Use a collation that ends with `_CI_AS_KS`. We recommend using a collation that ends with `_100_CI_AS_KS`.
- For optimum performance, enable the SQL Server Read-Committed Snapshot. For details, see [CTX 137161](#).
- Configured high availability features, if applicable.
- To configure mirroring, first set the database to use the full recovery model (simple model is the default). Back up the principal database to a file and copy it to the mirror server. Then, restore the backup file on the mirror server. Finally, start mirroring on the principal server.

The database administrator uses the SQLCMD command-line utility or SQL Server Management Studio in SQLCMD mode to:

- Run each of the `xxx_Replica.sql` scripts on the high availability SQL Server database instances (if high availability is configured)
- Run each of the `xxx_Principal.sql` scripts on the principal SQL Server database instances.

See the Microsoft documentation for SQLCMD details.

When all the scripts complete successfully, the database administrator gives the Citrix administrator the three principal database addresses.

Web Studio prompts you to continue the site creation. You are returned to the **Databases** page. Enter the addresses. If any of the servers hosting a database cannot be contacted, an error message appears.

Permissions required to set up databases

You must be a local administrator and a domain user to create and initialize the databases (or change the database location). You must also have certain SQL Server permissions. The following permissions can be explicitly configured or acquired by Active Directory group membership. If your Web Studio user credentials do not include these permissions, you are prompted for SQL Server user credentials.

Operation	Purpose	Server role	Database role
Create a database	Create a suitable empty database	<code>dbcreator</code>	
Create a schema	Create all service-specific schemas and add the first Controller to the site	<code>securityadmin*</code>	<code>db_owner</code>
Add a Controller	Add a Controller (other than the first) to the site	<code>securityadmin*</code>	<code>db_owner</code>
Add a Controller (mirror server)	Add a Controller login to the database server currently in the mirror role of a mirrored database	<code>securityadmin*</code>	
Remove Controller	Remove controller from site	**	<code>db_owner</code>
Update a schema	Apply schema updates or hotfixes		<code>db_owner</code>

* While technically more restrictive, in practice, you can treat the `securityadmin` server role as equivalent to the `sysadmin` server role.

** When a Controller is removed from a site, the Controller logon to the database server is not removed. This is to avoid potentially removing a logon being used by services other than this Citrix product on the same machine. The logon must be removed manually if it is no longer required. This action requires `securityadmin` server role membership.

When using Web Studio to perform these operations, the Web Studio user must either have a database server account that is explicitly a member of the appropriate server roles, or be able to provide credentials of an account that is.

Preferred database rights scripts

In enterprise environments, database setup includes scripts that must be handled by different teams with different roles (rights): `securityadmin` or `db_owner`.

Using PowerShell, you can specify the preferred database rights. Specifying a nondefault value results in the creation of separate scripts. One script contains tasks that need the `securityadmin` role. The other script requires only `db_owner` rights and can be run by a Citrix administrator, without having to contact a database administrator.

In the `get-DBSchema` cmdlets, the `-DatabaseRights` option has the following valid values:

- **SA**: Generates a script that creates the databases and the Delivery Controller login. These tasks require `securityadmin` rights.
- **DBO**: Generates a script that creates the user roles in the database, adds the logins, and then creates the database schemas. These tasks require `db_owner` rights.
- **Mixed**: (Default) All tasks in one script, regardless of required rights.

For more information, see the cmdlet help.

Database address formats

You can specify a database address in one of the following forms:

- `ServerName`
- `ServerName\InstanceName`
- `ServerName,PortNumber`

For an AlwaysOn Availability Group, specify the group's listener in the location field.

Change database locations

After you create a site, you can change the location of the configuration logging and monitoring databases. (You cannot change the location of the site database.) When you change the location of a database:

- The data in the previous database is not imported to the new database.
- Logs cannot be aggregated from both databases when retrieving logs.

- The first log entry in the new database indicates that a database change occurred, but it does not identify the previous database.

You cannot change the location of the configuration logging database when mandatory logging is enabled.

To change the location of a database:

1. Ensure a supported version of Microsoft SQL Server is installed on the server where you want the database to reside. Set up high availability features as needed.
2. Sign in to Web Studio, and then select **Settings** in the left pane.
3. Locate the **Database** tile and select **Edit**.
4. On the **Manage Database** page, select the database for which you want to specify a new location and then select **Change Database** in the action bar.
5. Specify the new location and the database name.
6. If you want Web Studio to create the database and you have the appropriate permissions, click **Done**. When prompted, click **Done**, and then Web Studio creates the database automatically. Web Studio attempts to access the database using your credentials. If that fails, you are prompted for the database user's credentials. Web Studio then uploads the database schema to the database. The credentials are retained only for the database creation time frame.
7. If you do not want Web Studio to create the database, or you do not have sufficient permissions, click **Generate database script**. The generated scripts include instructions for manually creating the database and a mirror database, if needed. Before uploading the schema, ensure that the database is empty and that at least one user has permission to access and change the database.

More information

- [Database sizing tool](#).
- [Sizing the site database](#) and [configuring connection strings](#) when using SQL Server high availability solutions.

Delivery methods

March 23, 2023

Citrix Virtual Apps and Desktops offers various delivery methods. A single delivery method will likely not meet all of your requirements.

Introduction

Choosing the appropriate application delivery method helps improve scalability, management, and user experience.

- **Installed app:** The application is part of the base desktop image. The install process involves dll, exe, and other files copied to the image drive, in addition to registry modifications. For details, see [Create machine catalogs](#).
- **Streamed app (Microsoft App-V):** The application is profiled and delivered to the desktops across the network on demand. Application files and registry settings are placed in a container on the virtual desktop and isolated from the base operating system and each other. This isolation helps address compatibility issues. For details, see [Deploy and deliver App-V applications](#).
- **Layered app (Citrix App Layering):** Each layer contains a single application, agent, or operating system. By integrating one OS layer, one platform layer (VDA, Citrix Provisioning agent) and many application layers, an administrator can easily create new, deployable images. Layering simplifies ongoing maintenance, as an OS, agent, and application exists in a single layer. When you update the layer, all deployed images containing that layer are updated. For details, see [Citrix App Layering](#).
- **Hosted Windows app:** An application installed on a multi-user Citrix Virtual Apps host and deployed as an application and not a desktop. A user accesses the hosted Windows app seamlessly from the VDI desktop or endpoint device, hiding the fact that the app is executing remotely. For details, see [Create delivery groups](#).
- **Local app:** An application deployed on the endpoint device. The application interface appears within the user's hosted VDI session, even though it executes on the endpoint. For details, see [Local App Access and URL redirection](#).

For desktops, consider published desktops or VDI desktops.

Citrix Virtual Apps published apps and desktops

Use multi-session OS machines to deliver Citrix Virtual Apps and Desktops published apps and published desktops.

Use case:

- You want inexpensive server-based delivery to minimize the cost of delivering applications to many users, while providing a secure, high-definition user experience.
- Your users perform well-defined tasks and do not require personalization or offline access to applications. Users can include task workers such as call center operators and retail workers, or users that share workstations.
- Application types: any application.

Benefits and considerations:

- Manageable and scalable solution within your data center.
- Most cost effective application delivery solution.
- Hosted applications are managed centrally and users cannot modify the application. This provides a user experience that is consistent, safe, and reliable.
- Users must be online to access their applications.

User experience:

- User requests one or more applications from StoreFront, their **Start** menu, or a URL you provide.
- Applications are delivered virtually and display seamlessly in high definition on user devices.
- Depending on profile settings, user changes are saved when the user's application session ends. Otherwise, the changes are deleted.

Process, host, and deliver applications:

- Application processing takes place on hosting machines, rather than on the user devices. The hosting machine can be a physical or a virtual machine.
- Applications and desktops reside on a multi-session OS machine.
- Machines become available through machine catalogs.
- Machines from machine catalogs are organized into delivery groups that deliver the same set of applications to groups of users.
- Multi-session OS machines support delivery groups that host either desktops or applications, or both.

Session management and assignment:

- Multi-session OS machines run multiple sessions from a single machine to deliver multiple applications and desktops to multiple, simultaneously connected users. Each user requires a single session from which they can run all their hosted applications.

For example, a user logs on and requests an application. One session on that machine becomes unavailable to other users. A second user logs on and requests an application which that machine hosts. A second session on the same machine is now unavailable. If both users request more applications, no additional sessions are required because a user can run multiple applications using the same session. If two more users log on and request desktops, and two sessions are available on that same machine, that single machine is now using four sessions to host four different users.

- Within the delivery group to which a user is assigned, a machine on the least loaded server is selected. A machine with session availability is randomly assigned to deliver applications to a user when that user logs on.

VM hosted apps

Use single-session OS machines to deliver VM hosted applications

Use case:

- You want a client-based application delivery solution that is secure, provides centralized management, and supports many users per host server. You want to provide those users with applications that display seamlessly in high definition.
- Your users are internal, external contractors, third-party collaborators, and other provisional team members. Your users do not require offline access to hosted applications.
- Application types: Applications that might not work well with other applications or might interact with the operation system, such as Microsoft .NET Framework. These types of applications are ideal for hosting on virtual machines.

Benefits and considerations:

- Applications and desktops on the master image are securely managed, hosted, and run on machines within your data center, providing a more cost-effective application delivery solution.
- On logon, users can be randomly assigned to a machine within a delivery group that is configured to host the same application. You can also statically assign a single machine to deliver an application to a single user each time that user logs on. Statically assigned machines allow users to install and manage their own applications on the virtual machine.
- Running multiple sessions is not supported on single-session OS machines. Therefore, each user consumes a single machine within a delivery group when they log on, and users must be online to access their applications.
- This method can increase the amount of server resources for processing applications and increase the amount of storage for users' data.

User experience:

- The same seamless application experience as hosting shared applications on multi-session OS machines.

Process, host, and deliver applications:

- The same as multi-session OS machines except they are virtual single-session OS machines.

Session management and assignment:

- Single-session OS machines run a single desktop session from a single machine. When accessing applications only, a single user can use multiple applications (and is not limited to a single application) because the operating system sees each application as a new session.

- Within a delivery group, when users log on they can access either a statically assigned machine (each time the user logs on to the same machine), or a randomly assigned machine that is selected based on session availability.

VDI desktops

Use single-session OS machines to deliver Citrix Virtual Apps and Desktops VDI desktops.

VDI desktops are hosted on virtual machines and provide each user with a desktop operating system.

VDI desktops require more resources than published desktops, but do not require that applications installed on them support server-based operating systems. Also, depending on the type of VDI desktop you choose, these desktops can be assigned to individual users. This allows users a high level of personalization.

When you create a machine catalog for VDI desktops, you create one of these types of desktops:

- **Random non-persistent desktop, also known as pooled VDI desktop:** Each time a user logs on to one of these desktops, that user connects to a desktop selected from a pool of desktops. That pool is based on a single master image. All changes to the desktop are lost when the machine restarts.
- **Static non-persistent desktop:** During the first logon, a user is assigned a desktop from a pool of desktops. (Each machine in the pool is based on a single master image.) After the first use, each time a user logs on to use a desktop, that user connects to the same desktop that was assigned on first use. All changes to the desktop are lost when the machine restarts.
- **Static persistent desktop:** Unlike other types of VDI desktops, users can fully personalize these desktops. During the first logon, a user is assigned a desktop from a pool of desktops. Subsequent logons from that user connect to the same desktop that was assigned on first use. Changes to the desktop are retained when the machine restarts.

Remote PC Access

Remote PC Access is a feature of Citrix Virtual Apps and Desktops that enables organizations to easily allow their employees to access corporate resources remotely in a secure manner. The Citrix platform makes this secure access possible by giving users access to their physical office PCs. If users can access their office PCs, they can access all the applications, data, and resources they need to do their work. Remote PC Access eliminates the need to introduce and provide other tools to accommodate teleworking. For example, virtual desktops or applications and their associated infrastructure.

Remote PC Access uses the same Citrix Virtual Apps and Desktops components that deliver virtual desktops and applications. As a result, the requirements and process of deploying and configuring

Remote PC Access are the same as those required for deploying Citrix Virtual Apps and Desktops for the delivery of virtual resources. This uniformity provides a consistent and unified administrative experience. Users receive the best user experience by using Citrix HDX to deliver their office PC session.

For more information, [Remote PC Access](#).

Network ports

March 24, 2021

Complete network port information is provided in [Communication Ports Used by Citrix Technologies](#).

When Citrix components are installed, the operating system's host firewall is also updated, by default, to match the default network ports.

You might need port information:

- For regulatory compliance.
- If there is a network firewall between the Citrix Virtual Apps and Desktops components and other Citrix products or components, so you can configure that firewall appropriately.
- If you use a third-party host firewall, such as one provided with an anti-malware package, rather than the operating system's host firewall.
- If you alter the configuration of the host firewall on these components (usually Windows Firewall Service).
- If you reconfigure component features to use a different port or port range, and then want to disable or block ports that aren't used in your configuration.

Some of the ports are registered with the Internet Assigned Numbers Authority (IANA). Details about these assignments are available at <http://www.iana.org/assignments/port-numbers>. However, the descriptive information held by IANA does not always reflect today's usage.

Also, the operating systems on the VDA and Delivery Controller require incoming ports for their own use. See the Microsoft Windows documentation for details.

HDX

February 12, 2024

Warning:

Editing the registry incorrectly can cause serious problems that might require you to reinstall your operating system. Citrix cannot guarantee that problems resulting from the incorrect use of Registry Editor can be solved. Use Registry Editor at your own risk. Be sure to back up the registry before you edit it.

Citrix HDX represents a broad set of technologies that deliver a high-definition experience to users of centralized applications and desktops, on any device and over any network.

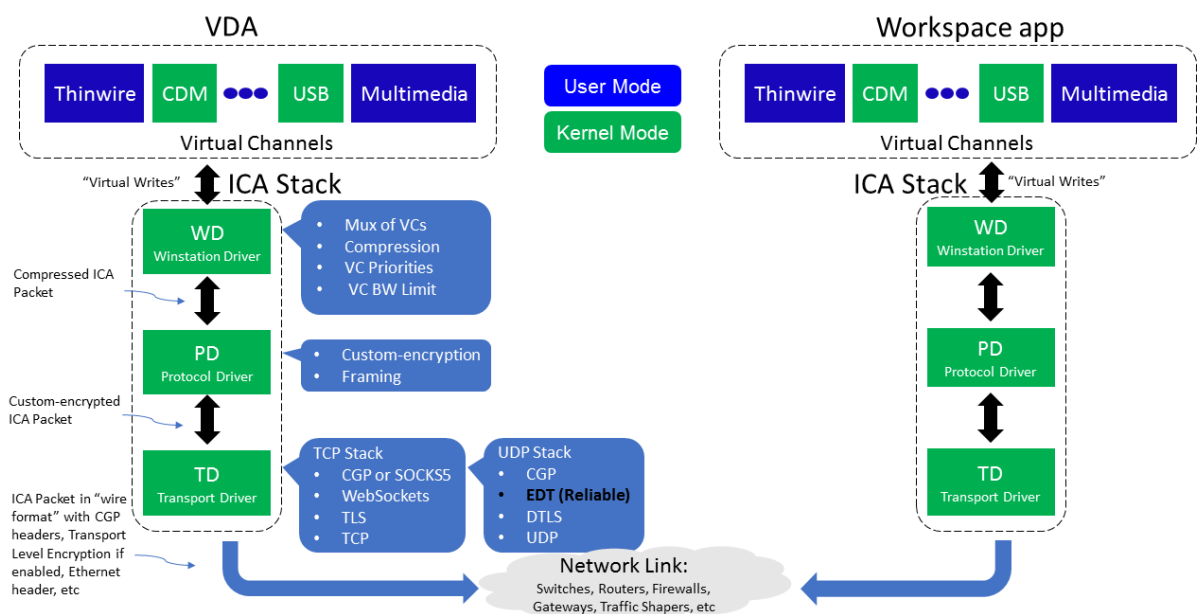

HDX is designed around three technical principles:

- Intelligent redirection
- Adaptive compression
- Data de-duplication

Applied in different combinations, they optimize the IT and user experience, decrease bandwidth consumption, and increase user density per hosting server.

- **Intelligent redirection** - Intelligent redirection examines screen activity, application commands, endpoint device, and network and server capabilities to instantly determine how and where to render an application or desktop activity. Rendering can occur on either the endpoint device or hosting server.
- **Adaptive compression** - Adaptive compression allows rich multimedia displays to be delivered on thin network connections. HDX first evaluates several variables, such as the type of input, device, and display (text, video, voice, and multimedia). It chooses the optimal compression

codec and the best proportion of CPU and GPU usage. It then intelligently adapts based on each unique user and basis. This intelligent adaptation is per user, or even per session.

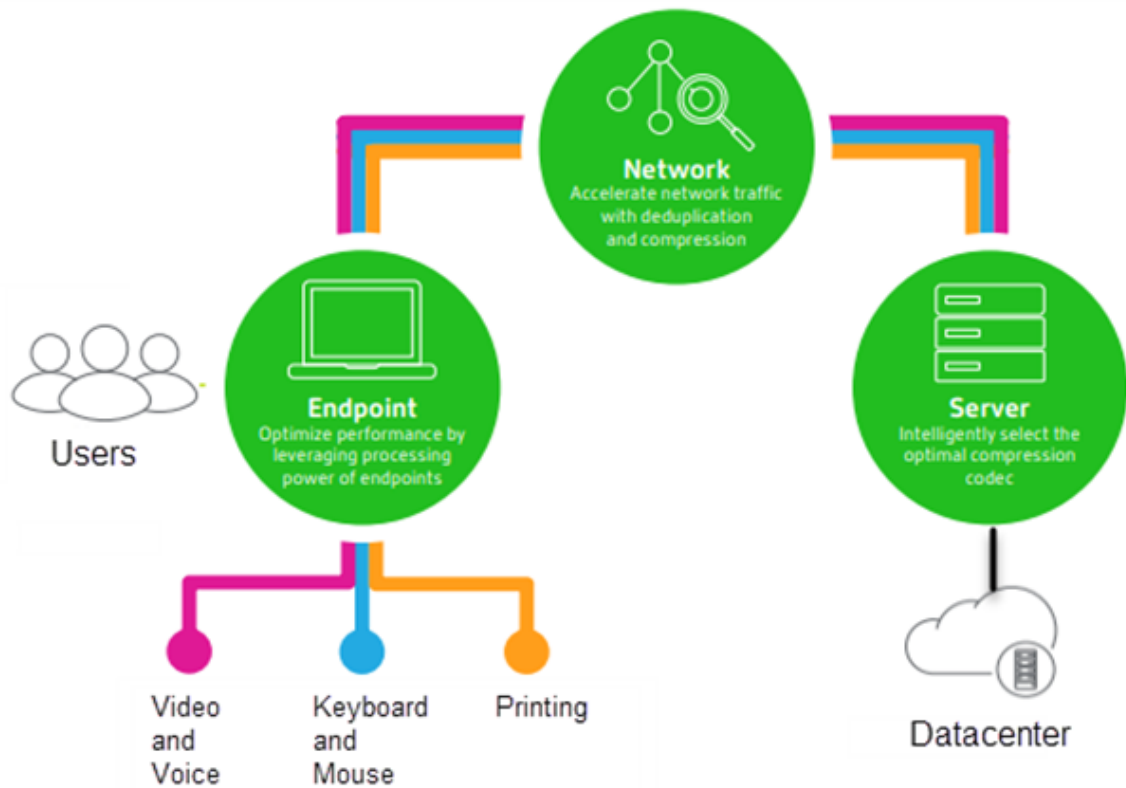

- **Data de-duplication** - De-duplication of network traffic reduces the aggregate data sent between client and server. It does so by taking advantage of repeated patterns in commonly accessed data such as bitmap graphics, documents, print jobs, and streamed media. Caching these patterns allows only the changes to be transmitted across the network, eliminating duplicate traffic. HDX also supports multicasting of multimedia streams, where a single transmission from the source is viewed by multiple subscribers at one location, rather than a one-to-one connection for each user.

For more information, see [Boost productivity with a high-definition user workspace](#).

At the device

HDX uses the computing capacity of user devices to enhance and optimize the user experience. HDX technology ensures that users receive a smooth, seamless experience with multimedia content in their virtual desktops or applications. Workspace control enables users to pause virtual desktops and applications and resume working from a different device at the point where they left off.

On the network

HDX incorporates advanced optimization and acceleration capabilities to deliver the best performance over any network, including low-bandwidth and high-latency WAN connections.

HDX features adapt to changes in the environment. The features balance performance and bandwidth. They apply the best technologies for each user scenario, whether the desktop or application is accessed locally on the corporate network or remotely from outside the corporate firewall.

In the data center

HDX uses the processing power and scalability of servers to deliver advanced graphical performance, regardless of the client device capabilities.

HDX channel monitoring provided by Citrix Director displays the status of connected HDX channels on user devices.

HDX Insight

HDX Insight is the integration of NetScaler Network Inspector and Performance Manager with Director. It captures data about ICA traffic and provides a dashboard view of real-time and historical details. This data includes client-side and server-side ICA session latency, bandwidth use of ICA channels, and the ICA round-trip time value of each session.

You can enable NetScaler to use the HDX Insight virtual channel to move all the required data points in an uncompressed format. If you disable this feature, the NetScaler device decrypts and decompresses the ICA traffic spread across various virtual channels. Using the single virtual channel lessens complexity, enhances scalability, and is more cost effective.

Minimum requirements:

- NetScaler version 12.0 Build 57.x
- Citrix Workspace app for Windows 1808
- Citrix Receiver for Windows 4.10
- Citrix Workspace app for Mac 1808
- Citrix Receiver for Mac 12.8

Enable or disable HDX Insight virtual channel

To disable this feature, set the Citrix NetScaler Application Flow service properties to Disabled. To enable, set the service to Automatic. In either case, we recommend that you restart the server machine after changing these properties. By default, this service is enabled (Automatic).

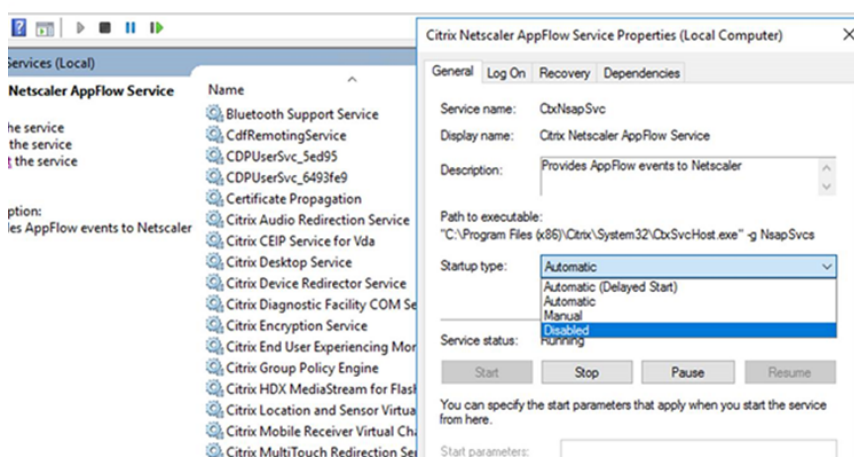

Experience HDX capabilities from your virtual desktop

- To see how browser content redirection, one of four HDX multimedia redirection technologies, accelerates delivery of HTML5 and WebRTC multimedia content:
 1. Download the [Chrome browser extension](#) and install it on the virtual desktop.
 2. To experience how browser content redirection accelerates the delivery of multimedia content to virtual desktops, view a video on your desktop from a website containing HTML5 videos, such as YouTube. Users don't know when browser content redirection is running. To see whether browser content redirection is being used, drag the browser window quickly. You'll see a delay or out of frame between the viewport and the user interface. You can also right-click on the webpage and look for **About HDX Browser Redirection** in the menu.
- To see how HDX delivers high definition audio:
 1. Configure your Citrix client for maximum audio quality; see the Citrix Workspace app documentation for details.
 2. Play music files by using a digital audio player (such as iTunes) on your desktop.

HDX provides a superior graphics and video experience for most users by default, and configuration isn't required. Citrix policy settings that provide the best experience for most use cases are enabled by default.

- HDX automatically selects the best delivery method based on the client, platform, application, and network bandwidth, and then self-tunes based on changing conditions.
- HDX optimizes the performance of 2D and 3D graphics and video.
- HDX enables user devices to stream multimedia files directly from the source provider on the internet or intranet, rather than through the host server. If the requirements for this client-side

content fetching are not met, media delivery falls back to server-side content fetching and multimedia redirection. Usually, adjustments to the multimedia redirection feature policies aren't needed.

- HDX delivers rich server-rendered video content to virtual desktops when multimedia redirection is not available: View a video on a website containing high definition videos, such as <http://www.microsoft.com/silverlight/iis-smooth-streaming/demo/>.

Good to know:

- For support and requirements information for HDX features, see the [System requirements](#) article. Except where otherwise noted, HDX features are available for supported Windows Multi-session OS and Windows Single-session OS machines, plus Remote PC Access desktops.
- This content describes how to optimize the user experience, improve server scalability, or reduce bandwidth requirements. For information about using Citrix policies and policy settings, see the [Citrix policies](#) documentation for this release.
- For instructions that include editing the registry, use caution: editing the registry incorrectly can cause serious problems that might require you to reinstall your operating system. Citrix cannot guarantee that problems resulting from the incorrect use of Registry Editor can be solved. Use Registry Editor at your own risk. Be sure to back up the registry before you edit it.

Auto client reconnect and session reliability

When accessing hosted applications or desktops, network interruption might occur. To experience a smoother reconnection, we offer auto client reconnect and session reliability. In a default configuration, session reliability starts and then auto client reconnect follows.

Auto client reconnect:

Auto client reconnect relaunches the client engine to reconnect to a disconnected session. Auto client reconnect closes (or disconnects) the user session after the time specified in the setting. If auto client reconnect is in progress, the system sends an application and desktops network interruption notification to the user as follows:

- **Desktops.** The session window is grayed out and a countdown timer displays the time until the reconnections occur.
- **Applications.** The session window closes and a dialog appears to the user containing a countdown timer showing the time until the reconnections are attempted.

During auto client reconnect, sessions relaunch expecting network connectivity. The user cannot interact with sessions while an auto client reconnect is in progress.

On reconnection, the disconnected sessions reconnect using saved connection information. The user can interact with the applications and desktops normally.

Default auto client reconnect settings:

- Auto client reconnect timeout: 120 seconds
- Auto client reconnect: Enabled
- Auto client reconnect authentication: Disabled
- Auto client reconnect Logging: Disabled

For more information, see [Auto client reconnect policy settings](#).

Session reliability:

Session reliability reconnects ICA sessions seamlessly across network interruptions. Session reliability closes (or disconnects) the user session after the time specified in the setting. After the session reliability timeout, the auto client reconnect settings take effect, attempting to reconnect the user to the disconnected session. When session reliability is in progress, application and desktops network interruption notification are sent to the user as follows:

- **Desktops.** The session window becomes translucent and a countdown timer displays the time until the reconnections occur.
- **Applications.** The window becomes translucent along with connection interrupted pop-ups from the notification area.

While session reliability is active, the user cannot interact with the ICA sessions. However, user actions like keystrokes are buffered for a few seconds immediately after the network interruption and retransmitted when the network is available.

On reconnection, the client and the server resume at the same point where they were in their exchange of protocol. The session windows lose translucency and appropriate notification area pop-ups are shown for applications.

Default session reliability settings

- Session reliability timeout: 180 seconds
- Reconnection UI opacity level: 80%
- Session reliability connection: Enabled
- Session reliability port number: 2598

For more information, see [Session reliability policy settings](#).

NetScaler with auto client reconnect and session reliability:

If Multistream and Multiport policies are enabled on the server and any or all these conditions are true, auto client reconnect does not work:

- Session reliability is disabled on NetScaler Gateway.
- A failover occurs on the NetScaler appliance.
- NetScaler SD-WAN is used with NetScaler Gateway.

HDX adaptive throughput

HDX adaptive throughput intelligently fine-tunes the peak throughput of the ICA session by adjusting output buffers. The number of output buffers is initially set at a high value. This high value allows data to be transmitted to the client more quickly and efficiently, especially in high latency networks. Providing better interactivity, faster file transfers, smoother video playback, higher framerate, and resolution results in an enhanced user experience.

Session interactivity is constantly measured to determine whether any data streams within the ICA session are adversely affecting interactivity. If that occurs, the throughput is decreased to reduce the impact of the large data stream on the session and allow interactivity to recover.

Important:

HDX adaptive throughput changes the way that output buffers are set by moving this mechanism from the client to the VDA, and no manual configuration is necessary.

This feature has the following requirements:

- VDA version 1811 or later
- Workspace app for Windows 1811 or later

Improve the image quality sent to user devices

The following visual display policy settings control the quality of images sent from virtual desktops to user devices.

- Visual quality. Controls the visual quality of images displayed on the user device: medium, high, always lossless, build to lossless (default = medium). The actual video quality using the default setting of medium depends on available bandwidth.
- Target frame rate. Specifies the maximum number of frames per second that are sent from the virtual desktop to the user device (default = 30). For devices that have slower CPUs, specifying a lower value can improve the user experience. The maximum supported frame rate per second is 60.
- Display memory limit. Specifies the maximum video buffer size for the session in kilobytes (default = 65536 KB). For connections requiring more color depth and higher resolution, increase the limit. You can calculate the maximum memory required.

Note:

The **Display Memory Limit** setting has been deprecated. With this change, Citrix now no longer limits the display memory. Instead, the minimum amount of memory required is allocated to ensure the client's display layout is fully accommodated.

Improve video conference performance

Several popular video conferencing applications are optimized for delivery from Citrix Virtual Apps and Desktops through multimedia redirection (see, for example, [HDX RealTime Optimization Pack](#)). For applications that are not optimized, HDX webcam video compression improves bandwidth efficiency and latency tolerance for webcams during video conferencing in a session. This technology streams webcam traffic over a dedicated multimedia virtual channel. This technology uses less bandwidth compared to the isochronous HDX Plug-n-Play USB redirection support, and works well over WAN connections.

Citrix Workspace app users can override the default behavior by choosing the Desktop Viewer Mic & Webcam setting **Don't use my microphone or webcam**. To prevent users from switching from HDX webcam video compression, disable USB device redirection by using the policy settings under ICA policy settings > USB Devices policy settings.

HDX webcam video compression requires that the following policy settings be enabled (all are enabled by default).

- Client audio redirection
- Client microphone redirection
- Multimedia conferencing

If a webcam supports hardware encoding, HDX video compression uses the hardware encoding by default. Hardware encoding might consume more bandwidth than software encoding. To force software compression, add the following DWORD key value to the registry key: HKCU\Software\Citrix\HdxRealTime: DeepCompress_ForceSWEncode=1.

Network traffic priorities

Priorities are assigned to network traffic across multiple connections for a session using Quality of Service supported routers. Four TCP streams and two User Datagram Protocol (UDP) streams are available to carry ICA traffic between the user device and the server:

- TCP streams - real time, interactive, background, and bulk
- UDP streams - voice and Framehawk display remoting

Each virtual channel is associated with a specific priority and transported in the corresponding connection. You can set the channels independently, based on the TCP port number used for the connection.

Multiple channel streaming connections are supported for Virtual Delivery Agents (VDAs) installed on Windows 10, Windows 8, and Windows 7 machines. Work with your network administrator to ensure the Common Gateway Protocol (CGP) ports configured in the **Multi-Port Policy** setting are assigned correctly on the network routers.

Quality of Service is supported only when multiple session reliability ports, or the CGP ports, are configured.

Warning:

Use transport security when using this feature. Citrix recommends using Internet Protocol Security (IPsec) or Transport Layer Security (TLS). TLS connections are supported only when the connections traverse a NetScaler Gateway that supports multi-stream ICA. On an internal corporate network, multi-stream connections with TLS are not supported.

To set Quality of Service for multiple streaming connections, add the following Citrix policy settings to a policy (see [Multi-stream connections policy settings](#) for details):

- Multi-Port policy - This setting specifies ports for ICA traffic across multiple connections, and establishes network priorities.
 - Select a priority from the CGP default port priority list. By default, the primary port (2598) has a High priority.
 - Type more CGP ports in CGP port1, CGP port2, and CGP port3 as needed, and identify priorities for each. Each port must have a unique priority.

Explicitly configure the firewalls on VDAs to allow the additional TCP traffic.

- Multi-Stream computer setting - This setting is disabled by default. If you use Citrix NetScaler SD-WAN with Multi-Stream support in your environment, you do not need to configure this setting. Configure this policy setting when using third-party routers or legacy NetScaler SD-WAN to achieve the desired Quality of Service.
- Multi-Stream user setting - This setting is disabled by default.

For policies containing these settings to take effect, users must log off and then log on to the network.

Show or hide the remote language bar

The language bar displays the preferred input language in an application session. If this feature is enabled (default), you can show or hide the language bar from the **Advanced Preferences > Language bar** UI in Citrix Workspace app for Windows. By using a registry setting on the VDA side, you can disable client control of the language bar feature. If this feature is disabled, the client UI setting doesn't take effect, and the per user current setting determines the language bar state. For more information, see [Improve the user experience](#).

To disable client control of the language bar feature from the VDA:

1. In the registry editor, navigate to HKEY_LOCAL_MACHINE\SYSTEM\CurrentControlSet\Control\Citrix\wfshell
2. Create a DWORD value key, SeamlessFlags, and set it to 0x40000.

Unicode keyboard mapping

Non-Windows Citrix Receivers use the local keyboard layout (Unicode). If a user changes the local keyboard layout and the server keyboard layout (scan code), they might not be in sync and the output is incorrect. For example, User1 changes the local keyboard layout from English to German. User1 then changes the server-side keyboard to German. Even though both keyboard layouts are German, they might not be in sync causing incorrect character output.

Enable or disable Unicode keyboard layout mapping

By default, the feature is disabled on the VDA side. To enable the feature, toggle on the feature by using the registry editor regedit on the VDA. Add the following registry key:

KEY_LOCAL_MACHINE/SOFTWARE/Citrix/CtxKlMap

Name: EnableKlMap

Type: DWORD

Value: 1

To disable this feature, set **EnableKlMap** to 0 or delete the **CtxKlMap** key.

Enable Unicode keyboard layout mapping compatible mode

By default, Unicode keyboard layout mapping automatically hooks some windows API to reload the new Unicode keyboard layout map when you change the keyboard layout on the server side. A few applications cannot be hooked. To keep compatibility, you can change the feature to compatible mode to support these non-hooked applications. Add the following registry key:

HKEY_LOCAL_MACHINE/SOFTWARE/Citrix/CtxKlMap

Name: DisableWindowHook

Type: DWORD

Value: 1

To use normal Unicode keyboard layout mapping, set **DisableWindowHook** to 0.

Citrix ICA virtual channels

February 12, 2024

Warning:

Editing the registry incorrectly can cause serious problems that might require you to reinstall your operating system. Citrix cannot guarantee that problems resulting from the incorrect use of Registry Editor can be solved. Use Registry Editor at your own risk. Be sure to back up the registry before you edit it.

What are ICA virtual channels?

A large portion of the functionality and communication between the Citrix Workspace app and the Citrix Virtual Apps and Desktops servers occurs over virtual channels. Virtual channels are a necessary part of the remote computing experience with the Citrix Virtual Apps and Desktops servers. Virtual channels are used for:

- Audio
- COM ports
- Disks
- Graphics
- LPT ports
- Printers
- Smart cards
- Third-party custom virtual channels
- Video

New virtual channels are sometimes released with new versions of the Citrix Virtual Apps and Desktops servers and Citrix Workspace app products to provide more functionality.

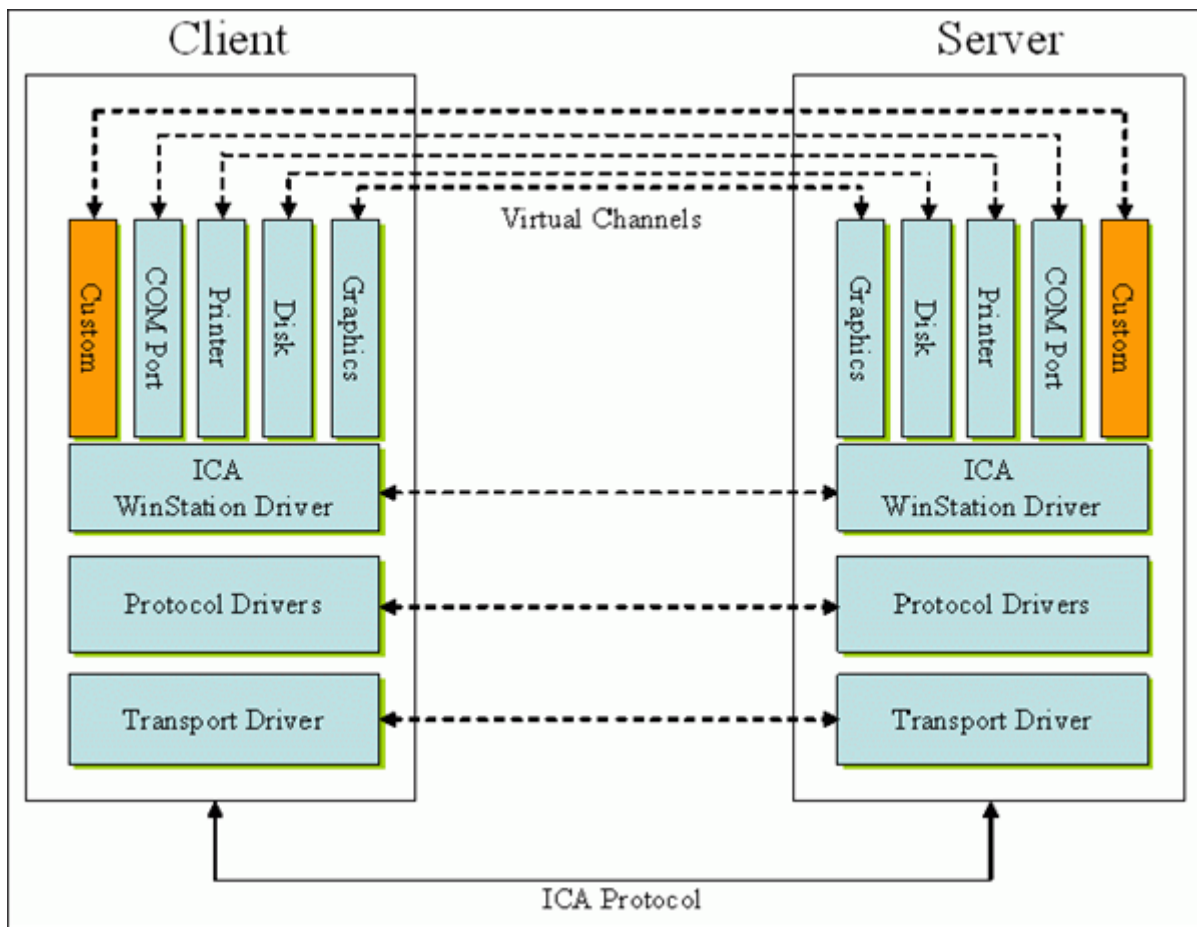

A virtual channel consists of a client-side virtual driver that communicates with a server-side application. Citrix Virtual Apps and Desktops ship with various virtual channels included. They're designed to allow customers and third-party vendors to create their own virtual channels by using one of the provided Software Development Kits (SDKs).

Virtual channels provide a secure way to accomplish various tasks. For example, an application that is running on a Citrix Virtual Apps server that is communicating with a client-side device or an application that is communicating with the client-side environment.

On the client side, virtual channels correspond to virtual drivers. Each virtual driver provides a specific function. Some are required for normal operation, and others are optional. Virtual drivers operate at the presentation layer protocol level. There can be several protocols active at any time by multiplexing channels that are provided by the Windows Station (WinStation) protocol layer.

The following functions are contained in the VirtualDriver registry value under this registry path:

`HKEY_LOCAL_MACHINE\SOFTWARE\Citrix\ICA Client\Engine\Configuration\Advanced\Modules\ICA 3.0`

Or

HKEY_LOCAL_MACHINE\SOFTWARE\WOW6432Node\Citrix\ICA Client\Engine\
Configuration\Advanced\Modules\ICA 3.0 (for 64-bit)

- Thinwire3.0 (Required)
- ClientDrive
- ClientPrinterQueue
- ClientPrinterPort
- Clipboard
- ClientComm
- ClientAudio
- LicenseHandler (Required)
- TWI (Required)
- SmartCard
- ICACTL (Required)
- SSPI
- TwainRdr
- UserEXperience
- Vd3d

Note:

You can disable specific client functionality by removing one or more of these values from the registry key. For example, if you wanted to remove the Client Clipboard, remove the word **Clipboard**.

This list contains the client virtual driver files and their respective functions. Citrix Virtual Apps and Citrix Workspace app for Windows use these files. They are in the form of Dynamic Link Libraries (user mode), and not Windows drivers (kernel mode) except for Generic USB as described in the Generic USB virtual channel.

- vd3dn.dll –Direct3D virtual channel used for desktop composition redirection
- vdcamN.dll –Bidirectional audio
- vdcdm30n.dll –Client drive mapping
- vdcom30N.dll - Client COM port mapping
- vdcpm30N.dll –Client printer mapping
- vdctlN.dll –ICA controls channel
- vddvc0n.dll –Dynamic virtual channel
- vdeuemn.dll - End user experience monitoring
- vdgusbn.dll –Generic USB virtual channel
- vdkbhook.dll –Transparent key pass-through
- vdlfpn.dll –Framehawk display channel over UDP like transport
- vdmn.dll –Multimedia support

- vdmrvc.dll –Mobile Receiver virtual channel
- vdmtn.dll - Multi-touch support
- vdscardn.dll –Smartcard support
- vdsens.dll –Sensors virtual channel
- vdspl30n.dll –Client UPD
- vdsspin.dll –Kerberos
- vdtuin.dll –Transparent UI
- vdtw30n.dll –Client Thinwire
- vdtwin.dll –Seamless
- vdtwn.dll –Twain

Some virtual channels are compiled into other files. For example Clipboard Mapping is available in wfica32.exe

64-bit compatibility

Citrix Workspace app for Windows is 64-bit compatible. As with most of the binaries compiled for 32 bit, these client files have 64-bit compiled equivalents:

- brapi64.dll
- confmgr.dll
- ctxlogging.dll
- ctxmui.dll
- icaconf.exe
- icaconfs.dll
- icafile.dll
- pnipcn64.dll
- pnsson.dll
- ssoncom.exe
- ssonstub.dll
- vdkbhook64.dll

Generic USB virtual channel

Generic USB virtual channel implementation uses two kernel mode drivers along with the virtual channel driver vdgusbn.dll:

- ctxusbm.sys
- ctxusbr.sys

How ICA virtual channels work

Virtual channels are loaded in multiple ways. The Shell (WfShell for the server and PicaShell for the workstation) load some virtual channels. Some virtual channels are hosted as windows services.

Virtual channel modules loaded by the Shell, for example:

- EUEM
- Twain
- Clipboard
- Multimedia
- Seamless session sharing
- Time Zone

Some are loaded as kernel mode, for example:

- CtxDvcs.sys –Dynamic virtual channel
- Icausb.sys –Generic USB redirection
- Picadm.sys –Client drive mapping
- Picaser.sys –COM port redirection
- Picapar.sys –LPT port redirection

Graphics virtual channel on the server side

The `ctxgfx.exe` hosts the graphics virtual channel for both workstation and terminal server based sessions. `ctxgfx` hosts platform specific modules that interact with the corresponding driver (`Icardd.dll` for RDSH and `vdod.dll` and `vidd.dll` for workstation).

For XenDesktop 3D Pro deployments an OEM graphics driver is installed for the corresponding GPU on the VDA. `ctxgfx` loads specialized adaptor modules to interact with the OEM graphics driver.

Hosting specialized channels in windows services

On Citrix Virtual Apps and Desktops servers, various channels are hosted as windows services. Such hosting provides one-to-many semantics for multiple applications in a session and multiple sessions on the server. Examples of such services include:

- Citrix Device Redirector Service
- Citrix Dynamic Virtual Channel Service
- Citrix End User Experience Monitoring Service
- Citrix Location and Sensor Virtual Channel Service
- Citrix MultiTouch Redirection Service

- Citrix Print Manager Service
- Citrix Smartcard Service
- Citrix Audio Redirection Service (Citrix Virtual Desktops only)
- Citrix ICA Status Channel Service

The audio virtual channel on Citrix Virtual Apps is hosted using Windows Audio service.

On the server side, all client virtual channels are routed through the WinStation driver, Wdica.sys. On the client side, the corresponding WinStation driver, built into wfica32.exe, polls the client virtual channels. This image illustrates the virtual channel client-server connection.

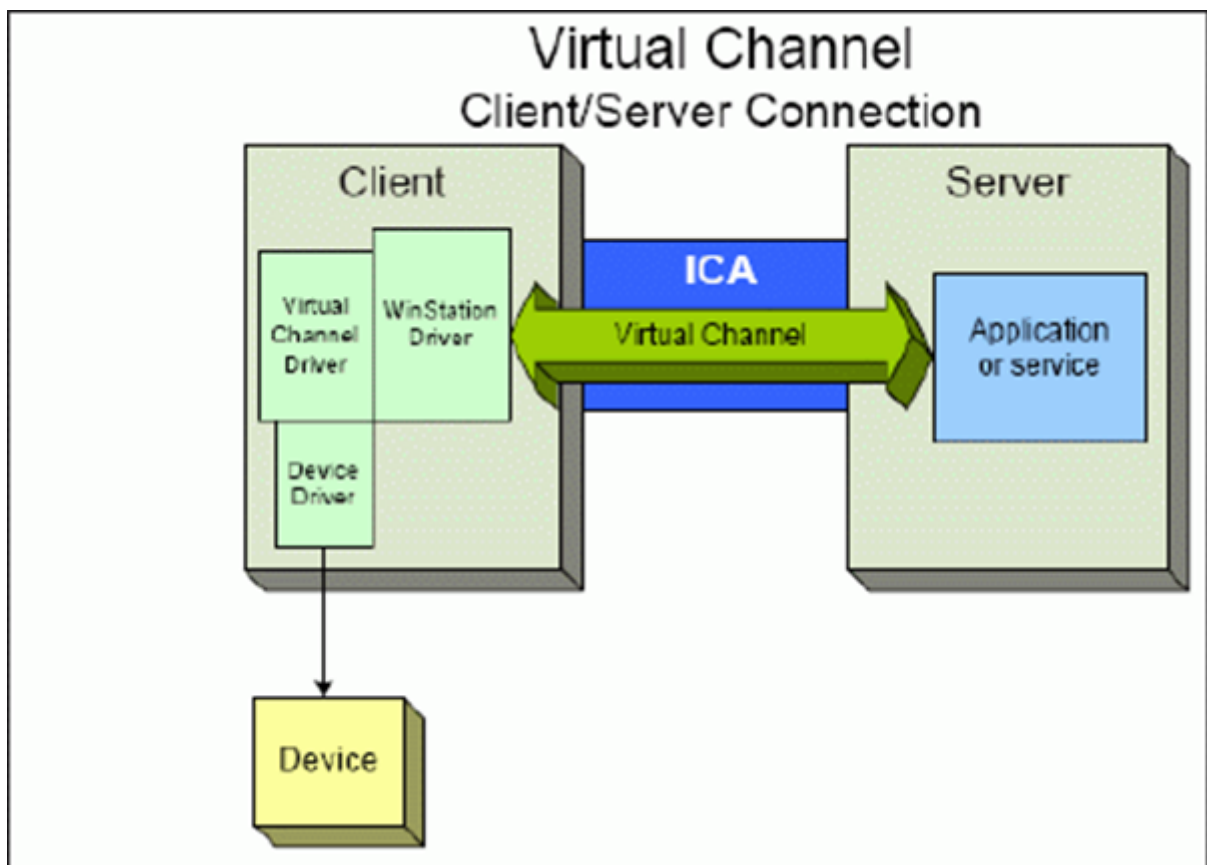

This overview contains a client-server data exchange using a virtual channel.

1. The client connects to the Citrix Virtual Apps and Desktops server. The client passes information about the virtual channels it supports to the server.
2. The server-side application starts, obtains a handle to the virtual channel, and optionally queries for additional information about the channel.
3. The client virtual driver and server-side application pass data using the following two methods:
 - If the server application has data to send to the client, the data is sent to the client immediately. When the client receives the data, the WinStation driver de-multiplexes the virtual channel data from the ICA stream and immediately passes it to the client virtual driver.

- If the client virtual driver has data to send to the server, the data is sent the next time the WinStation driver polls it. When the server receives the data, it is queued until the virtual channel application reads it. There is no way to alert the server virtual channel application that data was received.
4. When the server virtual channel application is completed, it closes the virtual channel and frees any allocated resources.

Creating your own virtual channel using the Virtual Channel SDK

Note:

Citrix SDKs are available in the Citrix Developer portal at <https://developer.cloud.com>.

Creating a virtual channel using the Virtual Channel SDK requires intermediate programming knowledge. Use this method to provide a major communication path between the client and the server. For example, if you are implementing usage of a device on the client side, such as a scanner, to be used with a process in the session.

Note:

- The Virtual Channel SDK requires the WFAPI SDK to write the server side of the virtual channel.
- Because of enhanced security for Citrix Virtual Apps and Desktops, you must specify which virtual channels are allowed to be opened in an ICA session. For more information, see [Virtual channel allow list policy settings](#).

Creating your own virtual channel using the ICA Client Object SDK

Creating a virtual channel using the ICA Client Object (ICO) is easier than using the Virtual Channel SDK. Use the ICO by creating a named object in your program using the **CreateChannels** method.

Important:

Because of enhanced security starting with the 10.00 version of the Citrix Receiver for Windows and later (and Citrix Workspace apps for Windows), you must take an extra step when creating an ICO virtual channel.

Pass-through functionality of virtual channels

Most virtual channels that Citrix provides operate unmodified when you use the Citrix Workspace app for Windows within an ICA session (also known as a pass-through session). There are considerations when using the client in extra hops.

The following functions operate the same way in single or multiple hops:

- Client COM port mapping
- Client drive mapping
- Client printer mapping
- Client UPD
- End user experience monitoring
- Generic USB
- Kerberos
- Multimedia support
- Smartcard support
- Transparent key pass-through
- Twain

As the inherent nature of latency and factors such as compression and decompression and rendering being performed at each hop, performance might be affected with each additional hop that the client undergoes. The affected areas are:

- Bidirectional audio
- File transfers
- Generic USB redirection
- Seamless
- Thinwire

Important:

By default, the client drives mapped by an instance of the client running in a pass-through session are restricted to the client drives of the connecting client.

Pass-through functionality of virtual channels between a Citrix Virtual Desktop session and a Citrix Virtual App session

Most virtual channels provided by Citrix operate unmodified when you use Citrix Workspace app for Windows within an ICA session on a Citrix Virtual Desktops server (also known as a pass-through session).

Specifically, on the Citrix Virtual Desktops server, there is a VDA hook that runs **picaPassthruHook**. This hook makes the client think it's running on a CPS server, and placing the client into its traditional pass-through mode.

We support the following traditional virtual channels and their functionality:

- Client
- Client COM port mapping

- Client drive mapping
- Client printer mapping
- Generic USB (limited due to performance)
- Multimedia support
- Smartcard support
- SSON
- Transparent key pass-through

Security and ICA virtual channels

Securing usage is an important part of planning, developing, and implementing virtual channels. There are several references to specific areas of security located throughout this document.

Best practices

Open virtual channels when you **Connect** and **Reconnect**. Close virtual channels when you log off and **Disconnect**.

Keep the following guidelines in mind when you create scripts that use virtual channel functions.

Naming the Virtual Channels:

You can create a maximum of 32 virtual channels. Seventeen of the 32 channels are reserved for special purposes.

- Virtual channel names must not be more than seven characters in length.
- The first three characters are reserved for the vendor name, and the next four for the channel type. For example, **CTXAUD** represents the Citrix audio virtual channel.

Virtual channels are referred to by a seven-character (or shorter) ASCII name. In some previous versions of the ICA protocol, virtual channels were numbered. The numbers are now assigned dynamically based on the ASCII name, making implementation easier. Users who are developing virtual channel code for internal use only can use any seven-character name that does not conflict with existing virtual channels. Use only numbers and upper and lowercase ASCII. Follow the existing naming convention when adding your own virtual channels. There are several predefined channels. The predefined channels begin with the OEM identifier CTX and are for use only by Citrix.

Double-Hop Support:

Virtual Channel	Is double hop supported?
Audio	No

Virtual Channel	Is double hop supported?
Browser Content Redirection	No
CDM	Yes
CEIP	No
Clipboard	Yes
Continuum (MRVC)	No
Control VC	Yes
HTML5 Video Redirection (v1)	Yes
Keyboard, Mouse	Yes
MultiTouch	No
NSAPVC	No
Printing	Yes
SensVC	No
Smartcard	Yes
Twain	Yes
USB VC	Yes
WAYCOM devices -K2M using USB VC	Yes
Webcam Video Compression	Yes
Windows Media Redirection	Yes

See also

- [ICA Virtual Channel SDK](#)
- The [Citrix Developer Network](#) is the home for all technical resources and discussions involving the use of Citrix SDKs. In this network, you can find access to SDKs, sample code and scripts, extensions and plug-ins, and SDK documentation. Also included are the Citrix Developer Network forums, where technical discussions take place around each of the Citrix SDKs.

Double hop in Citrix Virtual Apps and Desktops

April 8, 2021

In the context of a Citrix client session, the term “double hop” refers to a Citrix Virtual App session that is running within a Citrix Virtual Desktop session. The following diagram illustrates a double hop.

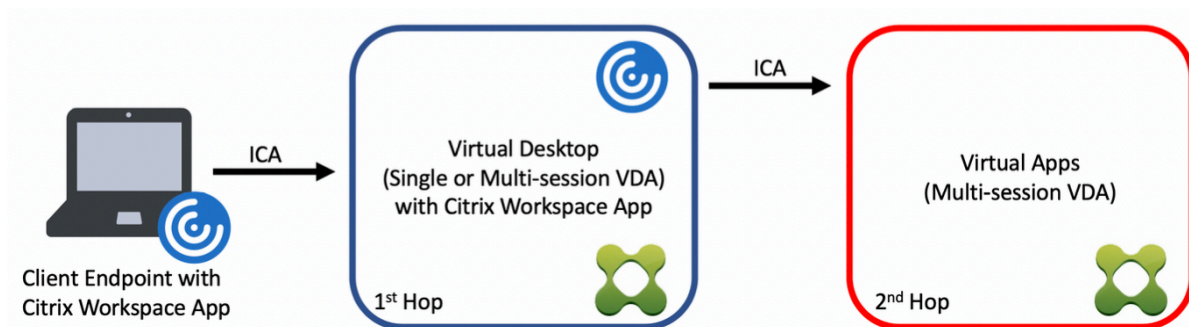

In a double hop scenario, when the user connects to a Citrix Virtual Desktop running on a single-session OS VDA (known as VDI) or a multi-session OS VDA (known as a published desktop), that is considered the first hop. After the user connects to the virtual desktop, the user can launch a Citrix Virtual Apps session. That is considered the second hop.

You can use a double hop deployment model to support various use cases. The case where the Citrix Virtual Desktop and the Citrix Virtual Apps environments are managed by different entities is one common example. This method can also be effective in resolving application compatibility issues.

System requirements

All Citrix Virtual Apps and Desktops editions including the Citrix Cloud service support double hop.

The first hop must use a supported version of the single-session or multi-session OS VDA and the Citrix Workspace App. The second hop must use a supported version of the multi-session OS VDA. See the [Product Matrix](#) page for supported versions.

For best performance and compatibility, Citrix recommends using a Citrix client of the same version or newer than the VDA versions in use.

In environments where the first hop involves a third-party (non-Citrix) virtual desktop solution in combination with a Citrix Virtual Apps session, support is limited to the Citrix Virtual Apps environment. In the event of any issues related to the third-party virtual desktop, including - but not limited to - Citrix Workspace app compatibility, redirection of hardware devices, and session performance, Citrix can provide technical support in a limited capacity. A Citrix Virtual Desktop at the first hop might be required as part of troubleshooting.

Deployment considerations for HDX in double hop

In general, each session in a double hop is unique and client-server functions are isolated to a given hop. This section includes areas that require special consideration by Citrix administrators. Citrix

recommends that customers conduct thorough testing of required HDX capabilities to ensure user experience and performance is adequate for a given environment configuration.

Graphics

Use default graphics settings (selective encoding) on the first and second hops. In the case of [HDX 3D Pro](#), Citrix highly recommends that all applications that require graphics acceleration run locally in the first hop with the appropriate GPU resources available to the VDA.

Latency

End-to-end latency can impact the overall user experience. Consider the added latency between the first and second hops. This is especially important with redirection of hardware devices.

Multimedia

Server-side (in session) rendering of audio and video content performs best in the first hop. Video playback in the second hop requires decoding and re-encoding at the first hop, increasing bandwidth and hardware resource utilization as a result. Audio and video content must be limited to the first hop whenever possible.

USB device redirection

HDX includes generic and optimized redirection modes to support a wide array of USB device types. Pay special attention to the mode in use at each hop and use the following table as reference for best results. For more information about generic and optimized redirection modes, see [Generic USB devices](#).

First hop (VDI or published desktop)	Second hop (Virtual apps)	Support notes
Optimized	Optimized	Recommended (based on device support). For example, USB mass storage, TWAIN scanners, Webcam, Audio.
Generic	Generic	For devices where the optimized option is not available.

First hop (VDI or published desktop)	Second hop (Virtual apps)	Support notes
Generic	Optimized	While technically possible, it is recommended to use the optimized mode across both hops when device support is available.
Optimized	Generic	Not supported

Note:

Due to the inherent chattiness of USB protocols, performance may decrease across hops. Functionality and results vary depending on specific device and application requirements. Validation testing is highly recommended in all cases of device redirection and especially important in double hop scenarios.

Support exceptions

Double hop sessions support most HDX features and capabilities except for the following:

- [Browser content redirection](#)
- [Local App Access](#)
- [RealTime Optimization Pack for Skype for Business](#)
- [Optimization for Microsoft Teams](#)

Install and configure

March 12, 2024

Review the referenced articles before starting each deployment step, to learn about what you see and specify during the deployment.

Use the following sequence to deploy Citrix Virtual Apps and Desktops.

Prepare

Review [Prepare to install](#) and complete any necessary tasks.

- Where to find information about concepts, features, differences from earlier releases, system requirements, and databases.
- Considerations when deciding where to install core components.
- Permission and Active Directory requirements.
- Information about the available installers, tools, and interfaces.

Install core components

Install the Delivery Controller, [Web Studio](#), Citrix Director, and Citrix License Server. You can also install Citrix StoreFront. For details, see [Install core components](#) or [Install using the command line](#).

Create a site

After you install the core components and launch Studio, you are prompted to [create a site](#).

Install one or more Virtual Delivery Agents (VDAs)

Install a VDA on a machine running a Windows operating system, either on a master image or directly on each machine. See [Install VDAs](#) or [Install using the command line](#). Sample [scripts](#) are provided if you want to install VDAs through Active Directory.

For machines with a Linux operating system, follow the guidance in [Linux Virtual Delivery Agent](#).

For a Remote PC Access deployment, install a VDA for a single-session OS on each office PC. If you need only the core VDA services, use the standalone `VDAWorkstationCoreSetup.exe` installer and your existing Electronic Software Distribution (ESD) methods. ([Prepare to install](#) describes the available VDA installers.)

Install optional components

If you plan to use the Citrix Universal Print Server, install its server component on your print servers. See [Install core components](#) or [Install using the command line](#).

To allow StoreFront to use authentication options such as SAML assertions, install the [Citrix Federated Authentication Service](#).

To enable end users to have greater control over their user accounts, install [Self-Service Password Reset](#).

Optionally, integrate more Citrix components into your Citrix Virtual Apps and Desktops deployment.

- [Citrix Provisioning](#) is an optional component that provisions machines by streaming a master image to target devices.
- [Citrix Gateway](#) is a secure application access solution that provides administrators with granular application-level policy and action controls to secure access to applications and data.
- [Citrix SD-WAN](#) is a set of appliances that optimize WAN performance.

Create a machine catalog

After you create a site in Studio, you are guided to [create a machine catalog](#).

A catalog can contain physical or virtual machines (VMs). Virtual machines can be created from a master image. When using a hypervisor or other service to provide VMs, you first create a master image on that host. Then, when you create the catalog, you specify that image, which is used when creating VMs.

Create a delivery group

After you create your first machine catalog in Web Studio, you are guided to [create a delivery group](#).

A delivery group specifies which users can access machines in a selected catalog and the applications available to those users.

Create an application group (optional)

After you create a delivery group, you can optionally [create an application group](#). You can create application groups for applications that are shared across different delivery groups or used by a subset of users within delivery groups.

Known limitation

When you use Citrix Workspace app for Windows version 1912 or earlier, the session drops after a while. This issue is fixed in the newer LTSR and CR versions of Citrix Workspace app.

For more information on the supported release versions, see [Citrix Workspace app for Windows / Citrix Receiver for Windows Long Term Service Releases](#).

Machine identities

September 9, 2023

Each machine must have a unique machine identity, also known as computer account. Machine identities can be created and managed in the machines locally or in a directory, such as on-premises Active Directory (AD) or Azure AD. Citrix supports hosting virtual applications and desktops on machines that are Active Directory joined, Azure Active Directory joined, Hybrid Azure Active Directory joined, or non-domain joined.

Machine identity types

The following machine identity types are supported.

Machine identity type	Description
AD joined	Identities are created and managed in on-premises Active Directory. Provisioned machines are joined to on-premises Active Directory using the assigned machine identities.
Hybrid Azure AD joined	Identities are created in on-premises Active Directory and are synced with Azure AD through Azure AD Connect. Provisioned machines are joined to on-premises Active Directory. The machines are then Hybrid Azure AD joined. For importing a Hybrid Azure AD joined VM, the VM is treated as an Active Directory joined VM by Citrix Virtual Apps and Desktops.

Supported Configurations

The following are details of the supported configurations for each scenario.

Supported infrastructure

Machine identity	Citrix Virtual Apps and Desktops	Citrix Workspace	Citrix StoreFront	Citrix Gateway Service	Citrix Gateway
AD joined	Yes	Yes	Yes	Yes	Yes
Azure AD joined	No	Yes	No	Yes	No

Machine identity	Citrix Virtual Apps and Desktops			Citrix Gateway Service	Citrix Gateway
	Citrix Workspace	Citrix StoreFront			
Hybrid Azure AD joined	Yes	Yes	Yes	Yes	Yes
Non-domain-joined	No	Yes	No	Yes	No

Supported workspace authentication identity providers

Machine identity	Azure Active Directory	Active Directory	Active Directory and Token	Okta	SAML	Citrix Gateway	Adaptive Authentication
	AD joined	Yes	Yes	Yes	Yes	Yes	Yes
Azure AD joined	Yes	No	No	No	No	No	No
Hybrid Azure AD joined	Yes	Yes	Yes	Yes	Yes	Yes	Yes
Non-domain-joined	Yes	Yes	Yes	Yes	Yes	Yes	Yes

Active Directory joined

February 12, 2024

Active Directory is required for authentication and authorization. The Kerberos infrastructure in Active Directory is used to guarantee the authenticity and confidentiality of communications with the Delivery Controllers. For information about Kerberos, see the Microsoft documentation.

The [System requirements](#) article lists the supported functional levels for the forest and domain. To use Policy Modeling, the domain controller must be running on Windows Server 2003 to Windows Server 2012 R2. This does not affect the domain functional level.

This product supports:

- **Deployments in which the user accounts and computer accounts exist in domains in a single Active Directory forest.** User and computer accounts can exist in arbitrary domains within a single forest. All domain functional levels and forest functional levels are supported in this type of deployment.
- **Deployments in which user accounts exist in an Active Directory forest that is different from the Active Directory forest containing the computer accounts of the Controllers and virtual desktops.** In this type of deployment, the domains containing the Controller and virtual desktop computer accounts must trust the domains containing user accounts. Forest trusts or external trusts can be used. All domain functional levels and forest functional levels are supported in this type of deployment.
- **Deployments in which the computer accounts for Controllers exist in an Active Directory forest that is different from one or more additional Active Directory forests that contain the computer accounts of the virtual desktops.** In this type of deployment a bi-directional trust must exist between the domains containing the Controller computer accounts and all domains containing the virtual desktop computer accounts. In this type of deployment, all domains containing Controller or virtual desktop computer accounts must be at “Windows 2000 native” functional level or higher. All forest functional levels are supported.
- **Writable domain controllers.** Read-only domain controllers are not supported.

Optionally, Virtual Delivery Agents (VDAs) can use information published in Active Directory to determine which Controllers they can register with (discovery). This method is supported primarily for backward compatibility, and is available only if the VDAs are in the same Active Directory forest as the Controllers. For information about this discovery method see [Active Directory OU-based discovery](#) and [CTX118976](#).

Note:

Do not change the computer name or the domain membership of a Delivery Controller after the site is configured.

Deploy in a multiple Active Directory forest environment

In an Active Directory environment with multiple forests, if one-way or two-way trusts are in place you can use DNS forwarders or conditional forwarders for name lookup and registration. To allow the appropriate Active Directory users to create computer accounts, use the Delegation of Control wizard. See the Microsoft documentation for details about this wizard.

No reverse DNS zones are necessary in the DNS infrastructure if appropriate DNS forwarders are in place between forests.

The `SupportMultipleForest` key is necessary if the VDA and Controller are in separate forests, regardless of whether the Active Directory and NetBIOS names are different. Use the following information to add the registry key to the VDA and the Delivery Controllers:

Caution:

Editing the registry incorrectly can cause serious problems that might require you to reinstall your operating system. Citrix cannot guarantee that problems resulting from the incorrect use of Registry Editor can be solved. Use Registry Editor at your own risk. Back up the registry before you edit it.

On the VDA, configure: `HKEY_LOCAL_MACHINE\Software\Citrix\VirtualDesktopAgent\SupportMultipleForest`.

- Name: `SupportMultipleForest`
- Type: `REG_DWORD`
- Data: `0x00000001` (1)

On all Delivery Controllers, configure: `HKEY_LOCAL_MACHINE\Software\Citrix\DesktopServer\SupportMultipleForest`.

- Name: `SupportMultipleForest`
- Type: `REG_DWORD`
- Data: `0x00000001` (1)

You might need reverse DNS configuration if your DNS namespace is different than that of Active Directory.

A registry entry has been added to avoid unwanted enabling of NTLM authentication in VDAs, which is less secure than Kerberos. This entry can be used instead of the `SupportMultipleForest` entry, which can still be used for backwards compatibility.

On the VDA, configure: `HKEY_LOCAL_MACHINE\Software\Policies\Citrix\VirtualDesktopAgent`.

- Name: `SupportMultipleForestDdcLookup`
- Type: `REG_DWORD`
- Data: `0x00000001` (1)

This registry key performs a DDC lookup in a two-way trust multiple forest environment that allows you to remove NTLM-based authentication during the initial registration process.

If external trusts are in place during setup, the `ListOfSIDs` registry key is required. The `ListOfSIDs` registry key is also necessary if the Active Directory FQDN is different than the DNS FQDN, or if the domain containing the Domain Controller has a different NetBIOS name than the Active Directory FQDN. To add the registry key, use the following information:

For the VDA, locate the registry key `HKEY_LOCAL_MACHINE\Software\Citrix\VirtualDesktopAgent\ListOfSIDs`.

- Name: `ListOfSIDs`
- Type: `REG_SZ`
- Data: Security Identifier (SID) of the Controllers. (SIDs are included in the results of the `Get-BrokerController` cmdlet.)

When external trusts are in place, make the following change on the VDA:

1. Locate the file `Program Files\Citrix\Virtual Desktop Agent\brokeragent.exe.config`.
2. Make a backup copy of the file.
3. Open the file in a text editing program such as Notepad.
4. Locate the text `allowNtlm="false"` and change the text to `allowNtlm="true"`.
5. Save the file.

After adding the `ListOfSIDs` registry key and editing the `brokeragent.exe.config` file, restart the Citrix Desktop Service to apply the changes.

The following table lists the supported trust types:

Trust type	Transitivity	Direction	Supported in this release
Parent and child	Transitive	Two-way	Yes
Tree-root	Transitive	Two-way	Yes
External	Nontransitive	One-way or two-way	Yes
Forest	Transitive	One-way or two-way	Yes
Shortcut	Transitive	One-way or two-way	Yes
Realm	Transitive or nontransitive	One-way or two-way	No

For more information about complex Active Directory environments, see [CTX134971](#).

Hybrid Azure Active Directory joined

June 27, 2023

This article describes the requirements to create Hybrid Azure Active Directory (HAAD) joined catalogs using Citrix DaaS in addition to the requirements outlined in the Citrix DaaS system requirements section.

Hybrid Azure AD joined machines use on-premises AD as the authentication provider. You can assign them to domain users or groups in on-premises AD. To enable Azure AD seamless SSO experience, you need to have the domain users synced to Azure AD.

Note:

Hybrid Azure AD joined VMs are supported in both federated and managed identity infrastructures.

Requirements

- VDA type: Single-session (desktops only) or multi-session (apps and desktops)
- VDA version: 2212 or later
- Provisioning type: Machine Creation Services (MCS), Persistent and Non-persistent
- Assignment type: Dedicated and pooled
- Hosting platform: Any hypervisor or cloud service

Limitations

- If Citrix Federated Authentication Service (FAS) is used, single sign-on is directed to on-premises AD rather than Azure AD. In this case, it is recommended to configure Azure AD certificate-based authentication so that the primary refresh token (PRT) is generated upon user logon, which facilitates single sign-on to Azure AD resources within the session. Otherwise, the PRT will not be present and SSO to Azure AD resources will not work. For information on achieving Azure AD single sign-on (SSO) to hybrid joined VDAs using Citrix Federated Authentication Service (FAS), see [Hybrid-joined VDAs](#).
- Do not skip image preparation while creating or updating machine catalogs. If you want to skip image preparation, make sure the master VMs are not Azure AD or Hybrid Azure AD joined.

Considerations

- Creating hybrid Azure Active Directory joined machines requires the `Write userCertificate` permission in the target domain. Make sure that you enter credentials of an administrator with that permission during catalog creation.
- The hybrid Azure AD joining process is managed by Citrix. You need to disable `autoWorkplaceJoin` controlled by Windows in the master VMs as follows. The task of manually disabling `autoWorkplaceJoin` is only required for VDA version 2212 or earlier.

1. Run `gpedit.msc`.
 2. Navigate to **Computer Configuration > Administrative Templates > Windows Components > Device Registration**.
 3. Set **Register domain joined computers as devices** to **Disabled**.
- Select the Organizational Unit (OU) that is configured to be synced with Azure AD when you create the machine identities.
 - For Windows 11 22H2 based master VM, create a scheduled task in the master VM that executes the following commands at system startup using SYSTEM account. This task of scheduling a task in the master VM is only required for VDA version 2212 or earlier.

```
1 $VirtualDesktopKeyPath = 'HKLM:\Software\AzureAD\VirtualDesktop'
2 $WorkplaceJoinKeyPath = 'HKLM:\SOFTWARE\Policies\Microsoft\
   WorkplaceJoin'
3 $MaxCount = 60
4
5 for ($count = 1; $count -le $MaxCount; $count++)
6 {
7
8     if ((Test-Path -Path $VirtualDesktopKeyPath) -eq $true)
9     {
10
11         $provider = (Get-Item -Path $VirtualDesktopKeyPath).GetValue(
12             "Provider", $null)
13         if ($provider -eq 'Citrix')
14         {
15             break;
16         }
17
18         if ($provider -eq 1)
19         {
20
21             Set-ItemProperty -Path $VirtualDesktopKeyPath -Name "
22                 Provider" -Value "Citrix" -Force
23             Set-ItemProperty -Path $WorkplaceJoinKeyPath -Name "
24                 autoWorkplaceJoin" -Value 1 -Force
25             Start-Sleep 5
26             dsregcmd /join
27             break
28         }
29     }
30
31     Start-Sleep 1
32 }
33
34
35 <!--NeedCopy-->
```

Where to go next

For more information on creating Hybrid Azure Active Directory joined catalogs, see [Create Hybrid Azure Active Directory joined catalogs](#).

Prepare to install

February 23, 2024

Deploying Citrix Virtual Apps and Desktops begins with installing the following components. This process prepares for the delivery of applications and desktops to users inside your firewall.

- One or more Delivery Controllers
- Citrix Director
- Citrix StoreFront
- Citrix License Server
- One or more Citrix Virtual Delivery Agents (VDAs)
- Optional components and technologies such as the Universal Print Server, the Federated Authentication Service, and Self-Service Password Reset

For users outside your firewall, install and configure an extra component, such as Citrix Gateway. For an introduction, see [Integrate Citrix Virtual Apps and Desktops with Citrix Gateway](#).

Note:

Make sure that the following Microsoft prerequisites are met on the server OS and the workstation OS:

- Microsoft **Volume Shadow Copy** and **Microsoft Software Shadow Copy Provider** services are running. For more information, see [Volume Shadow Copy Service](#).
- The **MS-Defender** version must be higher than 4.18.2105.5. For more information, see [Microsoft Defender Antivirus security intelligence and product updates](#).

If your deployment includes Windows Server workloads, configure a Microsoft RDS License Server.

You can use the full-product installer on the product ISO to deploy many components and technologies. You can use a standalone VDA installer to install VDAs. The standalone VDA installers are available on the Citrix download site. All installers offer graphical and command line interfaces. See [Installers](#).

The product ISO contains sample scripts that install, upgrade, or remove VDAs for machines in an Active Directory. You can also use the scripts to manage images used by Machine Creation Services (MCS) and Citrix Provisioning (formerly Provisioning Services). For details, see [Install VDAs using scripts](#).

Information to review before installation

- [Technical overview](#): To familiarize yourself with the product and its components.
- [Security](#): When planning your deployment environment.
- [Known issues](#): Issues you might come across in this version.
- [Databases](#): Learn about the system databases and how to configure them. During Controller installation, you can install SQL Server Express for use as the site database. You configure most database information when you create a site, after you install the core components.
- [Remote PC Access](#): If you're deploying an environment that enables your users to access their physical machines in the office remotely.
- [Connections and resources](#): If you're using a hypervisor or other service to host or provision VMs for applications and desktops. You can configure the first connection when you create a site (after you install the core components). Set up your virtualization environment before then.
- [Microsoft System Center Configuration Manager](#): If you're using ConfigMgr to manage access to applications and desktops, or if you're using the Wake on LAN feature with Remote PC Access.
- **Public Cloud host connections**: If you have a Hybrid Rights License, you can create host connections to the public cloud. For information related to the Hybrid Rights License, see [Hybrid Rights Renewals](#). For information related to public cloud entitlement and the reasons for this change, see [CTX270373](#).

Where to install components

Review the [System requirements](#) for supported platforms, operating systems, and versions. Component prerequisites are installed automatically, except as noted. See the Citrix StoreFront and the Citrix License Server documentation for their supported platforms and prerequisites.

You can install the core components on the same server or on different servers.

- Installing all the core components on one server can work for evaluation, test, or small production deployments.
- To accommodate future expansion, consider installing components on different servers. For example, installing Studio on a different machine than the server where you installed the Controller allows you to manage the site remotely.
- For most production deployments, installing core components on separate servers is recommended.

Install the Citrix License Server and licenses before installing other components on other servers.

- To install a supported component on a Server CoreOS (such as a Delivery Controller), you must [use the command line](#). That OS type does not offer a graphical interface, so install Studio and other tools elsewhere, and then point them to the Controller server.

You can install both a Delivery Controller and a VDA for multi-session OS on the same server. Launch the installer and select the Delivery Controller (plus any other core components you want on that machine). Then launch the installer again and select the **Virtual Delivery Agent** for multi-session OS.

Make sure that each operating system has the latest updates.

Make sure that all machines have synchronized system clocks. The Kerberos infrastructure that secures communication between the machines requires synchronization.

With XenServers, the virtual machine's power state might appear as unknown even if it appears registered. To resolve this issue, edit the registry key `HostTime` value to disable time synchronization with the host:

```
HKEY_LOCAL_MACHINE\Software\Citrix\XenTools\HostTime="Local"
```

```
HKEY_LOCAL_MACHINE\Software\Wow6432Node\Citrix\XenTools\HostTime="Local"
```

Tip:

The default value is `HostTime="UTC"`. Change this value to something other than UTC, for example, `Local`. This change effectively disables time synchronization with the host.

Optimization guidance for Windows 10 single-session machines is available in [CTX216252](#).

Where NOT to install components:

- Do not install any components on an Active Directory domain controller.
- Installing a Controller on a node in a SQL Server clustering installation, SQL Server mirroring installation, or on a server running Hyper-V is not supported.

If you try to install or upgrade a VDA on a Windows OS that this product version doesn't support, a message guides you to an article describing options.

Permission and Active Directory requirements

You must be a domain user and a local administrator on the machines where you are installing components.

To use a standalone VDA installer, you must have elevated administrative privileges or use **Run as administrator**.

Configure your Active Directory domain before starting an installation.

- [System requirements](#) lists the supported Active Directory functional levels. [Active Directory joined](#) contains more information.

- You must have at least one domain controller running Active Directory Domain Services.
- Do not install any Citrix Virtual Apps and Desktops components on a domain controller.
- Do not use a forward slash (/) when specifying Organizational Unit names in Studio.

The Windows user account used to install the Citrix License Server is automatically configured as a delegated administration full administrator.

For more information:

- [Security best practices](#)
- [Delegated administration](#)
- Microsoft documentation for Active Directory configuration

Installation guidance, considerations, and best practice

During installation of any component

- When installing or upgrading a Delivery Controller, Studio, License Server, or Director from the full-product media, if the Citrix installer detects that a restart is pending from a previous Windows installation on the machine, the installer stops with exit/return code 9. You are prompted to restart the machine.

This is not a Citrix forced restart. It is due to other components installed earlier on the machine. If this occurs, restart the machine and then launch the Citrix installer again.

When using the command-line interface, you can prevent the check for the pending restart by including the `/no_pending_reboot_check` option in the command.

- Usually, if a component has prerequisites, the installer deploys them if they are not present. Some prerequisites might require a machine restart.
- When you create objects before, during, and after installation, specify unique names for each object. For example, provide unique names for networks, groups, catalogs, and resources.
- If a component does not install successfully, the installation stops with an error message. Components that installed successfully are retained. You do not need to reinstall them.
- Citrix Analytics are collected automatically when you install (or upgrade) components. By default, that data is uploaded to Citrix automatically when the installation completes. Also, when you install components, you are automatically enrolled in the Citrix Customer Experience Improvement Program (CEIP), which uploads anonymous data.

During installation, you can also choose to participate in other Citrix technologies that collect diagnostics for maintenance and troubleshooting. For information about these programs, see [Citrix Insight Services](#).

- Google Analytics are collected (and later uploaded) automatically when you install (or upgrade) Studio. After installing Studio, you can change this setting with the registry key `HKLM\Software\Citrix\DesktopStudio\GAEnabled`. A value of **1** enables collection and upload, **0** disables collection and upload.
- If a VDA installation fails, an MSI analyzer parses the failing MSI log, displaying the exact error code. The analyzer suggests a CTX article, if it's a known issue. The analyzer also collects anonymized data about the failure error code. This data is included with other data collected by CEIP. If you end enrollment in CEIP, the collected MSI analyzer data is no longer sent to Citrix.

During VDA installation

- The Citrix Workspace app for Windows is available, but not installed by default when you install a VDA. You or your users can download and install (and upgrade) Citrix Workspace app for Windows and other Citrix Workspace apps from the Citrix website. Alternatively, you can make those Citrix Workspace apps available from your StoreFront server. See the StoreFront documentation.
- The Microsoft Print Spooler Service must be enabled. You cannot successfully install a VDA if that service is disabled.
- Most supported Windows editions come with Microsoft Media Foundation already installed. If the machine does not have Media Foundation (such as N editions), several multimedia features are not installed and will not work.
 - Windows Media Redirection
 - HTML5 Video Redirection
 - HDX RealTime Webcam Redirection

You can acknowledge the limitation, or end the VDA installation and restart it later, after installing Media Foundation. In the graphical interface, this choice is presented in a message. In the command line, you can use the `/no_mediafoundation_ack` option to acknowledge the limitation.

- When you install the VDA, a new local user group called **Direct Access Users** is created automatically. On a VDA for single-session OS, this group applies only to RDP connections. On a VDA for multi-session OS, this group applies to ICA and RDP connections.
- The VDA must have valid Controller addresses with which to communicate. Otherwise, sessions cannot be established. You can specify Controller addresses when you install the VDA or later. Remember that it must be done. For more information, see [VDA registration](#).

VDA supportability tools

Each VDA installer includes a supportability MSI that contains Citrix tools for checking the VDA performance, such as its overall health and the quality of connections. Enable or disable installation of this MSI on the **Additional Components** page of the VDA installer's graphical interface. From the command line, you can disable installation with the `/exclude "Citrix Supportability Tools"` option.

By default, the supportability MSI is installed in `c:\Program Files (x86)\Citrix\Supportability Tools\`. You can change this location on the **Components** page of the VDA installer's graphical interface, or with the `/installdir` command-line option. Keep in mind that changing the location changes it for all installed VDA components, not just the supportability tools.

Current tools in the supportability MSI:

- Citrix Health Assistant: For details, see [CTX207624](#).
- VDA Cleanup Utility: For details, see [CTX209255](#).

If you do not install the tools when you install the VDA, the CTX article contains a link to the current download package.

Restarts after and during VDA installation

A restart is required at the end of the VDA installation. That restart occurs automatically by default.

When you're upgrading a VDA to version 7.17 (or a later supported version), a restart occurs during the upgrade. This cannot be avoided.

To minimize the number of restarts needed during VDA installation:

- Ensure that a supported .NET Framework version is installed before beginning the VDA installation.
- For Windows multi-session OS machines, install and enable the RDS role services before installing the VDA.

If you do not install those prerequisites before installing the VDA:

- If you are using the graphical interface or the command line interface without the `/noreboot` option, the machine restarts automatically after installing the prerequisite.
- If you are using the command line interface with the `/noreboot` option, you must initiate the restart.

When you're upgrading a VDA version, a restart occurs during the upgrade. This cannot be avoided.

Restore on install or upgrade failure

Note:

This feature is available for single-session and multi-session VDAs.

If a single-session VDA installation or upgrade fails, and the “restore on failure” feature is enabled, the machine is returned to a restore point that was set before the installation or upgrade began.

If a multi-session VDA installation or upgrade fails, and the “restore on failure” feature is enabled, the machine is returned to a backup that was performed before the installation or upgrade began.

When a single-session VDA installation or upgrade starts with this feature enabled, the installer creates a system restore point before beginning the actual install or upgrade. If the VDA installation or upgrade fails, the machine is returned to the restore point state. The %temp%/Citrix folder contains deployment logs and other information about the restore.

When a multi-session VDA installation or upgrade starts with this feature enabled, the installer creates a server backup before beginning the actual install or upgrade. If the VDA installation or upgrade fails, the machine is returned to the backup state. The %temp%/Citrix folder contains deployment logs and other information about the restore. The amount of time to create the server backup is based on the size of the backup needed and the amount of resources available to the server. The backup is stored in *C:\WindowsImageBackup\servername*.

By default, this feature is disabled.

If you plan to enable this feature, make sure that system restore is not disabled through a GPO setting ([Computer Configuration](#) > [Administrative Templates](#) > [System](#) > [System Restore](#)).

Note:

This GPO setting does not apply to restoring a multi-session VDA.

To enable this feature when installing or upgrading a single or multi-session VDA:

- When using a VDA installer’s graphical interface (such as using **Autostart** or the [XenDesktopVDASetup.exe](#) command without any restore or quiet options), select the **Enable automatic restore if update fails** check box on the **Summary** page.

If the install/upgrade completes successfully, the restore point/backup is not used, but is retained.

- Run a VDA installer with either the [/enablerestore](#) or [/enablerestorecleanup](#) option using the command line.
 - If you use the [/enablerestorecleanup](#) option, and the install/upgrade completes successfully, the restore point/server backup is removed automatically.

- If you use the `/enablerestore` option, and the install/upgrade completes successfully, the restore point is not used, but is retained.

Installers

Full-product installer

Using the full-product installer provided in the ISO, you can:

- Install, upgrade, or remove core components: Delivery Controller, Studio, Director, and License Server.
- Install or upgrade StoreFront.
- Install or upgrade Windows VDAs for single-session or multi-session operating systems.
- Install the Universal Print Server `UpsServer` component on your print servers.
- Install the [Federated Authentication Service](#).
- Install [Session Recording](#).
- Install [Workspace Environment Management](#).

Note:

The Workspace Environment Management Agent installer is not localized. It is available only in English.

To deliver a desktop from a multi-session OS for one user (for example, for web development), use the full-product installer's command-line interface. For details, see [Server VDI](#).

Standalone VDA installers

Standalone VDA installers are available on the Citrix download pages. (They are not available from the product installation media.) The standalone VDA installers are much smaller than the full-product ISO. They more easily accommodate deployments that:

- Use Electronic Software Distribution (ESD) packages that are staged or copied locally
- Have physical machines
- Have remote offices

By default, files in the self-extracting standalone VDAs are extracted to the **Temp** folder. More disk space is required on the machine when extracting to the **Temp** folder than when using the full-product installer. However, files extracted to the **Temp** folder are automatically deleted after the installation completes. Alternatively, you can use the `/extract` command with an absolute path.

Three standalone VDA installers are available for download.

VDA`ServerSetup.exe`:

Installs a VDA for multi-session OS. It supports all the VDA for multi-session OS options that are available with the full-product installer.

VDA`WorkstationSetup.exe`:

Installs a VDA for single-session OS. It supports all the VDA for single-session OS options that are available with the full-product installer.

VDA`WorkstationCoreSetup.exe`:

Installs a VDA for single-session OS that is optimized for Remote PC Access deployments or core VDI installations. Remote PC Access uses physical machines. Core VDI installations are VMs that are not being used as an image. It installs only the core services necessary for VDA connections such deployments. Therefore, it supports only a subset of the options that are valid with the full-product or `VDAWorkstationSetup.exe` installers.

This installer does not install or contain the components used for:

- App-V.
- Profile Management. Excluding Citrix Profile Management from the installation affects Citrix Director displays. For details, see [Install VDAs](#).
- Machine Identity Service.
- Citrix Supportability Tools.
- Citrix Files for Windows.
- Citrix Files for Outlook.

The `VDAWorkstationCoreSetup.exe` installer does not install or contain a Citrix Workspace app for Windows.

Using `VDAWorkstationCoreSetup.exe` is equivalent to using the full-product or `VDAWorkstationSetup` installer to install a single-session OS VDA and either:

- In the graphical interface: Selecting the Remote PC Access option on the **Environment** page.
- In the command line interface: Specifying the `/remotepc` option.
- In the command line interface: Specifying `/components vda` plus the `/exclude` option that lists all of the valid additional component names.

You can install the omitted components/features later by running the full-product installer. That action enables you to install all missing components.

The `VDAWorkstationCoreSetup.exe` installer automatically installs the Browser Content Redirection MSI. This automatic installation applies to VDA release 2003 and later supported releases.

Citrix installation return codes

The installation log contains the result of component installations as a Citrix return code, not a Microsoft value.

- 0 = Success
- 1 = Failed
- 2 = PartialSuccess
- 3 = PartialSuccessAndRebootNeeded
- 4 = FailureAndRebootNeeded
- 5 = UserCanceled
- 6 = MissingCommandLineArgument
- 7 = NewerVersionFound

For example, when using tools such as Microsoft System Center Configuration Manager, a scripted VDA installation might appear to fail when the installation log contains the return code 3. This can occur when the VDA installer is waiting for a restart that you must initiate (for example, after an RDS role prerequisite installation on a server). A VDA installation is considered successful only after all prerequisites and selected components are installed, and the machine is restarted after the installation.

Alternatively, you can wrap your installation in CMD scripts (which return Microsoft exit codes) or change the success codes in your Configuration Manager package.

Configure a Microsoft RDS License Server for Windows Server workloads

This product accesses Windows Server remote session capabilities when delivering a Windows Server workload, such as Windows 2016. This typically requires a Remote Desktop Services client access license (RDS CAL). The VDA must be able to contact an RDS license server to request RDS CALs. Install and activate the license server. For more information, see the Microsoft document [Activate the Remote Desktop Services License Server](#). For proof of concept environments, you can use the grace period provided by Microsoft.

With this method, you can have this service apply the license server settings. You can configure the license server and per user mode in the RDS console on the image. You can also configure the license server using Microsoft Group Policy settings. For more information, see the Microsoft document [License your RDS deployment with client access licenses \(CALs\)](#).

To configure the RDS license server using Group Policy settings:

1. Install a Remote Desktop Services License Server on an available machine. The machine must always be available. The Citrix product workloads must be able to reach this license server.

2. Specify the license server address and per-user license mode using Microsoft Group Policy. For details, see the Microsoft document [Specify the Remote Desktop Licensing Mode for an RD Session Host Server](#).

Windows 10 workloads require appropriate Windows 10 license activation. We recommend that you follow Microsoft documentation to activate Windows 10 workloads.

More information

For setting up resource location for specific host types:

- [AWS cloud environments](#)
- [XenServer virtualization environments](#)
- [Google Cloud environments](#)
- [Microsoft Azure Resource Manager cloud environments](#)
- [Microsoft System Center Configuration Manager environments](#)
- [Microsoft System Center Virtual Machine Manager virtualization environments](#)
- [Nutanix virtualization environments](#)
- [Nutanix cloud and partner solutions](#)
- [VMware virtualization environments](#)
- [VMware cloud and partner solutions](#)

AWS cloud environments

March 20, 2024

This article walks you through setting up your AWS account as a resource location you can use with Citrix Virtual Apps and Desktops. The resource location includes a basic set of components, ideal for a proof-of-concept, or other deployment that does not require resources spread over multiple availability zones. After you complete these tasks, you can install VDAs, provision machines, create machine catalogs, and create Delivery Groups.

When you complete the tasks in this article, your resource location includes the following components:

- A virtual private cloud (VPC) with public and private subnets inside a single availability zone.
- An instance that runs as both an Active Directory Domain Controller and DNS server, located in the private subnet of the VPC.
- An instance that acts as a bastion host in the public subnet of your VPC. This instance is used to initiate RDP connections to the instances in the private subnet for administration purposes.

After you finish setting up your resource location, you can shut down this instance so it is no longer readily accessible. When you must manage other instances in the private subnet, such as VDA instances, you can restart the bastion host instance.

Task overview

Set up a virtual private cloud (VPC) with public and private subnets. When you complete this task, AWS deploys a NAT gateway with an Elastic IP address in the public subnet. This action enables instances in the private subnet to access the Internet. Instances in the public subnet are accessible to inbound public traffic while instances in the private subnet are not.

Configure security groups. Security groups act as virtual firewalls that control traffic for the instances in your VPC. You add rules to your security groups that allow instances in your public subnet to communicate with instances in your private subnet. You also associate these security groups with each instance in your VPC.

Create a DHCP options set. With an Amazon VPC, DHCP and DNS services are provided by default, which affects how you configure DNS on your Active Directory Domain Controller. Amazon's DHCP cannot be disabled and Amazon's DNS can be used only for public DNS resolution, not Active Directory name resolution. To specify the domain and name servers handed to instances through DHCP, create a DHCP options set. The set assigns the Active Directory domain suffix and specifies the DNS server for all instances in your VPC. To ensure Host (A) and Reverse Lookup (PTR) records are automatically registered when instances join the domain, you configure the network adapter properties for each instance you add to the private subnet.

Add a bastion host and Domain Controller to the VPC. Through the bastion host, you can log on to instances in the private subnet to set up the domain and join instances to the domain.

Task 1: Set up the VPC

1. From the AWS management console, select **VPC**.
2. From the VPC Dashboard, select **Create VPC**.
3. Select **VPC and more**.
4. Under NAT gateways (\$), select **In 1 AZ** or **1 per AZ**.
5. Under DNS options, leave **Enable DNS hostnames** selected.
6. Select **Create VPC**. AWS creates the public and private subnets, Internet gateway, route tables, and default security group.

Task 2: Configure security groups

This task creates and configures the following security groups for your VPC:

- A public security group to associate with the instances in your Public subnet.
- A private security group to associate with the instances in your Private subnet.

To create the security groups:

1. In the VPC Dashboard, select **Security Groups**.
2. Create a security group for the public security group. Select **Create Security Group** and enter a name tag and description for the group. In VPC, select the VPC you created earlier. Select **Yes, Create**.

Configure the Public security group

1. From the security group list, select the Public security group.
2. Select the **Inbound Rules** tab and select **Edit** to create the following rules:

Type	Source
ALL Traffic	Select the Private security group.
ALL Traffic	Select the Public security group.
ICMP	0.0.0.0/0
22 (SSH)	0.0.0.0/0
80 (HTTP)	0.0.0.0/0
443 (HTTPS)	0.0.0.0/0
1494 (ICA/HDX)	0.0.0.0/0
2598 (Session Reliability)	0.0.0.0/0
3389 (RDP)	0.0.0.0/0

3. When finished, select **Save**.
4. Select the **Outbound Rules** tab and select **Edit** to create the following rules:

Type	Destination
ALL Traffic	Select the Private security group.
ALL Traffic	0.0.0.0/0
ICMP	0.0.0.0/0

5. When finished, select **Save**.

Configure the private security group

1. From the security group list, select the Private security group.
2. If you have not setup traffic from the public security group, you must set TCP ports; select the **Inbound Rules** tab and select **Edit** to create the following rules:

Type	Source
ALL Traffic	Select the Private security group.
ALL Traffic	Select the Public security group.
ICMP	Select the Public security group.
TCP 53 (DNS)	Select the Public security group.
UDP 53 (DNS)	Select the Public security group.
80 (HTTP)	Select the Public security group.
TCP 135	Select the Public security group.
TCP 389	Select the Public security group.
UDP 389	Select the Public security group.
443 (HTTPS)	Select the Public security group.
TCP 1494 (ICA/HDX)	Select the Public security group.
TCP 2598 (Session Reliability)	Select the Public security group.
3389 (RDP)	Select the Public security group.
TCP 49152–65535	Select the Public security group.

3. When finished, select **Save**.
4. Select the **Outbound Rules** tab and select **Edit** to create the following rules:

Type	Destination
ALL Traffic	Select the Private security group.
ALL Traffic	0.0.0.0/0
ICMP	0.0.0.0/0
UDP 53 (DNS)	0.0.0.0/0

5. When finished, select **Save**.

Task 3: Launch instances

Do the following steps to create two EC2 instances and decrypt the default Administrator password that Amazon generates:

1. From the AWS management console, select **EC2**.
2. From the EC2 Dashboard, select **Launch Instance**.
3. Select a Windows Server machine image and instance type.
4. On the **Configure Instance Details** page, enter a name for the instance and select the VPC you set up earlier.
5. In **Subnet**, make the following selections for each instance:
 - Bastion host: Select the Public subnet
 - Domain Controller: Select the Private subnet
6. In **Auto-assign Public IP address**, make the following selections for each instance:
 - Bastion host: Select **Enable**.
 - Domain Controller: Select **Use default setting** or **Disable**.
7. In **Network Interfaces**, enter a primary IP address within the IP range of your private subnet for the Domain Controller.
8. If necessary, on the **Add Storage** page, modify the disk size.
9. On the **Tag Instance** page, enter a friendly name for each instance.
10. On the **Configure Security Groups** page, select **Select an existing security group** and then make the following selections for each instance:
 - Bastion host: Select the Public security group.
 - Domain Controller: Select the Private security group.
11. Review your selections and then select **Launch**.
12. Create a new key pair or select an existing one. If you create a new key pair, download your private key (.pem) file and keep it in a safe place. You must supply your private key when you acquire the default Administrator password for the instance.
13. Select **Launch Instances**. select **View Instances** to display a list of your instances. Wait until the newly launched instance has passed all status checks before accessing it.
14. Acquire the default Administrator password for each instance:
 - a) From the instance list, select the instance and then select **Connect**.

- b) Go to the **RDP client** tab, select **Get Password**, and upload your private key (.pem) file when prompted.
 - c) Select **Decrypt Password** to get the human readable password. AWS displays the default password.
15. Repeat the steps from step 2 until you have created two instances:
- One bastion host instance in your public subnet
 - One instance in your private subnet that is for use as a Domain Controller.

Task 4: Create a DHCP options set

1. From the VPC Dashboard, select **DHCP Options Sets**.
2. Enter the following information:
 - Name tag: Enter a friendly name for the set.
 - Domain name: Enter the fully qualified domain name that you use when you configure the Domain Controller instance.
 - Domain name servers: Enter the private IP address you assigned to the Domain Controller instance and the string **AmazonProvidedDNS**, separated by commas.
 - NTP servers: Leave this field blank.
 - NetBIOS name servers: Enter the private IP address of the Domain Controller instance.
 - NetBIOS node type: Enter **2**.
3. Select **Yes, Create**.
4. Associate the new set with your VPC:
 - a) From the VPC Dashboard, select **Your VPCs** and then select the VPC you set up earlier.
 - b) Select **Actions > Edit DHCP Options Set**.
 - c) When prompted, select the new set you created and then select **Save**.

Task 5: Configure the instances

1. Using an RDP client, connect to the public IP address of the bastion host instance. When prompted, enter the credentials for the Administrator account.
2. From the bastion host instance, launch Remote Desktop Connection and connect to the private IP address of the instance you want to configure. When prompted, enter the Administrator credentials for the instance.
3. For all instances in the private subnet, configure the DNS settings:

- a) Select **Start > Control Panel > Network and Internet > Network and Sharing Center > Change adapter settings**. Double-click the network connection displayed.
 - b) Select **Properties > Internet Protocol Version 4 (TCP/IPv4) > Properties**.
 - c) Select **Advanced > DNS**. Ensure that the following settings are enabled and select **OK**:
 - Register this connection's addresses in DNS
 - Use this connection's DNS suffix in DNS registration
4. To configure the Domain Controller:
- a) Using Server Manager, add the Active Directory Domain Services role with all default features.
 - b) Promote the instance to a Domain Controller. During promotion, enable DNS and use the domain name you specified when you created the DHCP options set. Restart the instance when prompted.

Where to go next

- [Install core components](#)
- [Install VDAs](#)
- [Create a site](#)
- For creating and managing a connection in AWS, see [Connection to AWS](#)

More information

- [Create and manage connections and resources](#)
- [Create machine catalogs](#)

XenServer virtualization environments

November 9, 2023

XenServer simplifies your operational management, ensuring a high-definition user experience for intensive workloads.

To set up your XenServer, see [Prepare to install](#).

Where to go next

- [Install core components](#)
- [Install VDAs](#)
- [Create a site](#)
- For creating and managing a connection in XenServer, see [Connection to XenServer](#)

More information

- [Create and manage connections and resources](#)
- [Create machine catalogs](#)

Google Cloud environments

April 4, 2024

Citrix Virtual Apps and Desktops lets you provision and manage machines on Google Cloud.

Requirements

- Citrix Cloud account. The feature described in this article is available only in Citrix Cloud.
- A Google Cloud project. The project stores all compute resources associated with the machine catalog. It can be an existing project or a new one.
- Enable four APIs in your Google Cloud project. For details, see [Enable Google Cloud APIs](#).
- Google Cloud service account. The service account authenticates to Google Cloud to enable access to the project. For details, see [Configure and update service accounts](#).
- Enable Google private access. For details, see [Enable-private-google-access](#).

Enable Google Cloud APIs

To use the Google Cloud functionality through Web Studio, enable these APIs in your Google Cloud project:

- Compute Engine API
- Cloud Resource Manager API
- Identity and Access Management (IAM) API
- Cloud Build API
- Cloud Key Management Service (KMS)

From the Google Cloud console, complete these steps:

1. In the upper left menu, select **APIs and Services > Dashboard**.

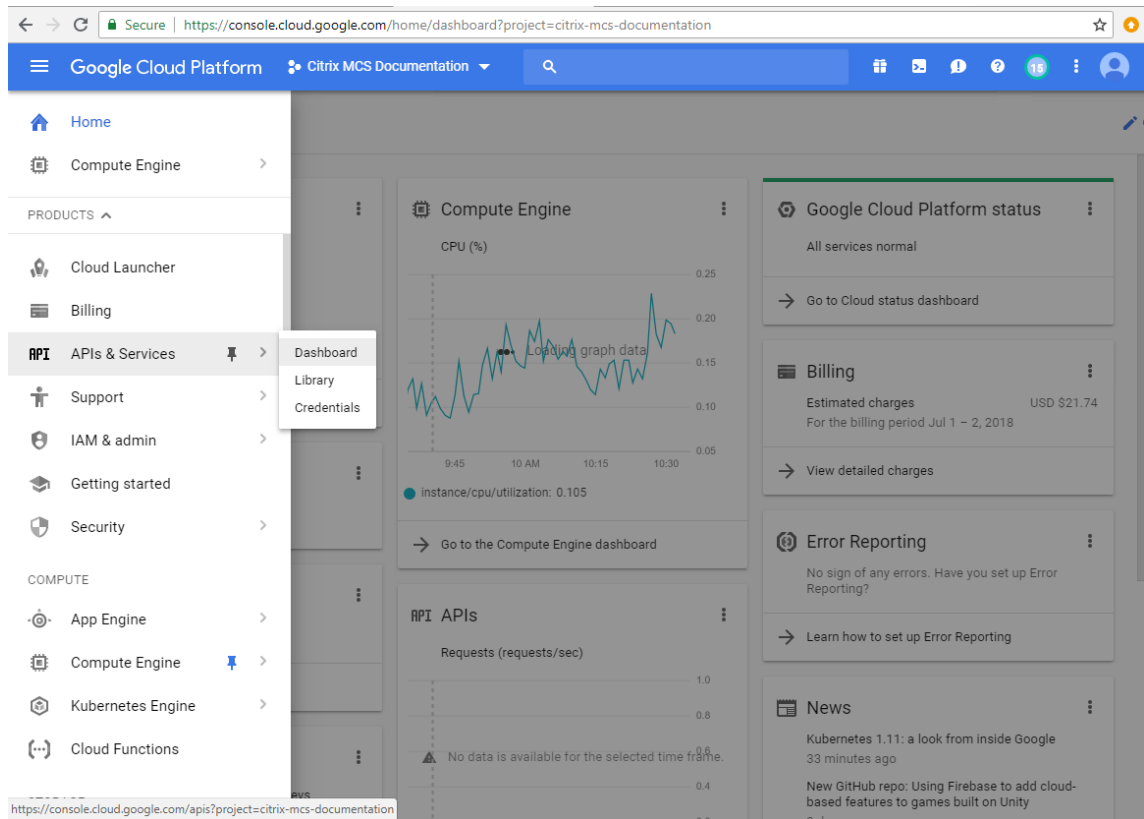

2. On the **Dashboard** screen, ensure that Compute Engine API is enabled. If not, follow these steps:
 - a) Navigate to **APIs and Services > Library**.

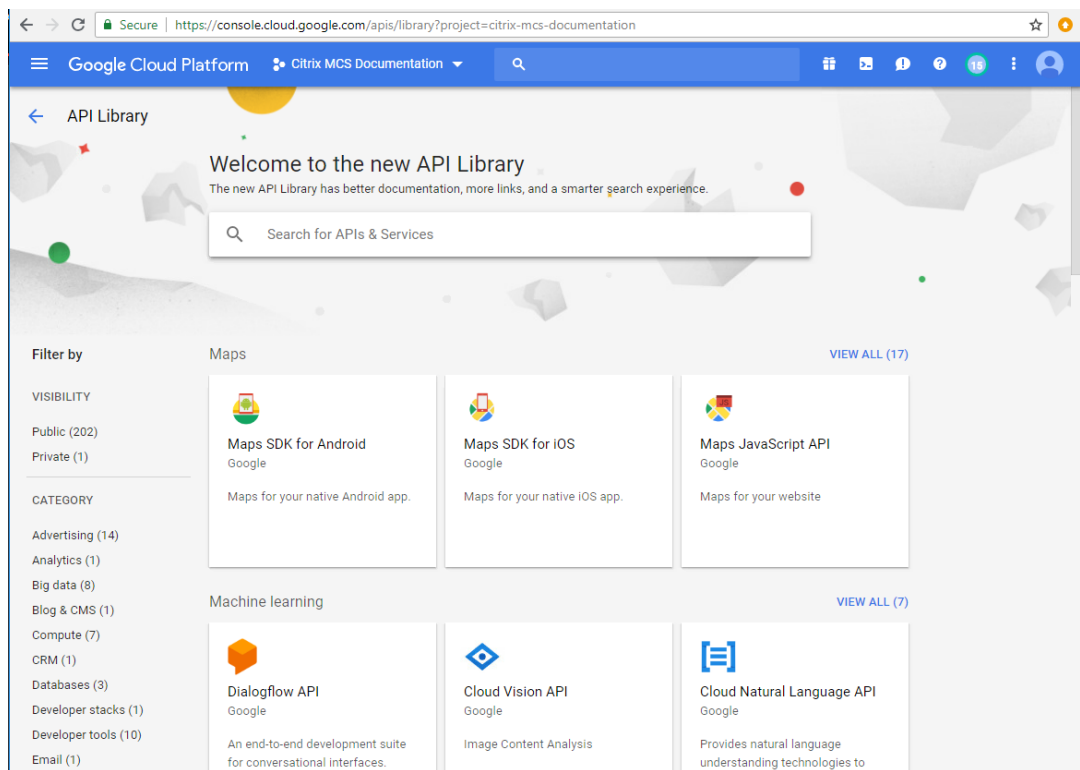

- b) In the search box, type *Compute Engine*.
 - c) From the search results, select **Compute Engine API**.
 - d) On the **Compute Engine API** page, select **Enable**.
3. Enable Cloud Resource Manager API.
 - a) Navigate to **APIs and Services > Library**.
 - b) In the search box, type *Cloud Resource Manager*.
 - c) From the search results, select **Cloud Resource Manager API**.
 - d) On the **Cloud Resource Manager API** page, select **Enable**. The status of the API appears.
4. Similarly, enable **Identity and Access Management (IAM) API** and **Cloud Build API**.

You can also use Google Cloud Shell to enable the APIs. To do this:

1. Open the Google Console and load the Cloud Shell.
2. Run the following four commands in the Cloud Shell:
 - `gcloud services enable compute.googleapis.com`
 - `gcloud services enable cloudresourcemanager.googleapis.com`
 - `gcloud services enable iam.googleapis.com`
 - `gcloud services enable cloudbuild.googleapis.com`

3. Click **Authorize** if the Cloud Shell prompts.

Configure and update service accounts

Note:

GCP is introducing changes to Cloud Build Service's default behavior and use of service accounts after April 29, 2024. For more information, see [Cloud Build Service Account Change](#). Your existing Google projects with Cloud Build API enabled before April 29, 2024 are not affected by this change. However, if you want to have existing Cloud Build Service behavior after April 29, you can create or apply the organization policy to disable the constraint enforcement before you enable the Cloud Build API. As a result, the following content is divided into two: Before April 29, 2024 and After April 29, 2024. If you set the new organization policy, follow the section Before April 29, 2024.

Before April 29, 2024

Citrix Cloud uses three separate service accounts within the Google Cloud project:

- *Citrix Cloud Service Account*: This service account enables Citrix Cloud to access the Google project, provision, and manage machines. This service account authenticates to Google Cloud using a [key](#) generated by Google Cloud.

You must create this service account manually as outlined here. For more information, see [Create a Citrix Cloud Service Account](#).

You can identify this service account with an email address. For example, `<my-service-account>@<project-id>.iam.gserviceaccount.com`.

- *Cloud Build Service Account*: This service account is provisioned automatically after you enable all the APIs mentioned in [Enable Google Cloud APIs](#). To view all automatically created service accounts, navigate to **IAM & Admin > IAM** in the **Google Cloud** console and select the **Include Google-provided role grants** checkbox.

You can identify this service account by an email address that begins with the **Project ID** and the word **cloudbuild**. For example, `<project-id>@cloudbuild.gserviceaccount.com`

Verify if the service account has been granted the following roles. If you must add roles, follow the steps outlined in [Add roles to the Cloud Build Service Account](#).

- Cloud Build Service Account
- Compute Instance Admin
- Service Account User

- *Cloud Compute Service Account*: This service account is added by Google Cloud to instances created in Google Cloud once the Compute API is activated. This account has the IAM basic editor role to do the operations. However, if you delete the default permission to have more granular control, you must add a **Storage Admin** role that requires the following permissions:
 - resourcemanager.projects.get
 - storage.objects.create
 - storage.objects.get
 - storage.objects.list

You can identify this service account by an email address that begins with the **Project ID** and the word **compute**. For example, <project-id>-compute@developer.gserviceaccount.com.

Create a Citrix Cloud Service Account To create a Citrix Cloud Service Account, follow these steps:

1. In the Google Cloud console, navigate to **IAM & Admin > Service accounts**.
2. On the **Service accounts** page, select **CREATE SERVICE ACCOUNT**.
3. On the **Create service account** page, enter the required information, and then select **CREATE AND CONTINUE**.
4. On the **Grant this service account access to project** page, click the **Select a role** drop-down menu and select the required roles. Click **+ADD ANOTHER ROLE** if you want to add more roles.

Each account (personal or service) has various roles defining the management of the project. Grant the following roles to this service account:

- Compute Admin
- Storage Admin
- Cloud Build Editor
- Service Account User
- Cloud Datastore User
- Cloud KMS Crypto Operator

The Cloud KMS Crypto Operator requires the following permissions:

- cloudkms.cryptoKeys.get
- cloudkms.cryptoKeys.list
- cloudkms.keyRings.get
- cloudkms.keyRings.list

Note:

Enable all the APIs to get the complete list of roles available while creating a new service account.

5. Click **CONTINUE**
6. On the **Grant users access to this service account** page, add users or groups to grant them access to perform actions in this service account.
7. Click **DONE**.
8. Navigate to the IAM main console.
9. Identify the service account created.
10. Validate the roles are assigned successfully.

Considerations:

When creating the service account, consider the following:

- The steps **Grant this service account access to project** and **Grant users access to this service account** are optional. If you choose to skip these optional configuration steps, the newly created service account does not display in the **IAM & Admin > IAM** page.
- To display roles associated with a service account, add the roles without skipping the optional steps. This process ensures that roles appear for the configured service account.

Citrix Cloud Service Account key The Citrix Cloud Service Account key is required for creating a connection in Citrix DaaS. The key is contained in a credential file (.json). The file is automatically downloaded and saved to the **Downloads** folder after you create the key. When you create the key, be sure to set the key type to JSON. Otherwise, the Citrix Full Configuration interface cannot parse it.

To create a Service Account Key, navigate to **IAM & Admin > Service accounts** and click the email address of the Citrix Cloud Service Account. Switch to the **Keys** tab and select **Add Key > Create new key**. Make sure to select **JSON** as the key type.

Tip:

Create keys using the **Service accounts** page in the Google Cloud console. We recommend that you change keys regularly for security purposes. You can provide new keys to the Citrix Virtual Apps and Desktops application by editing an existing Google Cloud connection.

Add roles to the Citrix Cloud Service Account To add roles to the Citrix Cloud Service Account:

1. In the Google Cloud console, navigate to **IAM & Admin > IAM**.

2. On the **IAM > PERMISSIONS** page, locate the service account you created, identifiable with an email address.

For example, `<my-service-account>@<project-id>.iam.gserviceaccount.com`

3. Select the pencil icon to edit the access to the principal of the service account.
4. On the **Edit access to “project-id”** page for the selected principal option, select **ADD ANOTHER ROLE** to add the required roles to your service account one by one and then select **SAVE**.

Add roles to the Cloud Build Service Account To add roles to the Cloud Build Service Account:

1. In the Google Cloud console, navigate to **IAM & Admin > IAM**.
2. On the **IAM** page, locate the Cloud Build service account, identifiable with an email address that begins with the **Project ID** and the word **cloudbuild**.

For example, `<project-id>@cloudbuild.gserviceaccount.com`

3. Select the pencil icon to edit the Cloud Build account roles.
4. On the **Edit access to “project-id”** page for the selected principal option, select **ADD ANOTHER ROLE** to add the required roles to your Cloud Build service account one by one and then select **SAVE**.

Note:

Enable all the APIs to get the complete list of roles.

After April 29, 2024

Citrix Cloud uses two separate service accounts within the Google Cloud project:

- *Citrix Cloud Service Account:* This service account enables Citrix Cloud to access the Google project, provision, and manage machines. This service account authenticates to Google Cloud using a [key](#) generated by Google Cloud.

You must create this service account manually.

You can identify this service account with an email address. For example, `<my-service-account>@<project-id>.iam.gserviceaccount.com`.

- *Cloud Compute Service Account:* This service account is provisioned automatically after you enable all the APIs mentioned in [Enable Google Cloud APIs](#). To view all automatically created service accounts, navigate to **IAM & Admin > IAM** in the **Google Cloud** console and select the **Include Google-provided role grants** checkbox. This account has the IAM basic editor role to do

the operations. However, if you delete the default permission to have more granular control, you must add **Storage Admin** role that requires the following permissions:

- resourcemanager.projects.get
- storage.objects.create
- storage.objects.get
- storage.objects.list

You can identify this service account by an email address that begins with the **Project ID** and the word **compute**. For example, <project-id>-compute@developer.gserviceaccount.com.

Verify if the service account has been granted the following roles.

- Cloud Build Service Account
- Compute Instance Admin
- Service Account User

Create a Citrix Cloud Service Account To create a Citrix Cloud Service Account, follow these steps:

1. In the Google Cloud console, navigate to **IAM & Admin > Service accounts**.
2. On the **Service accounts** page, select **CREATE SERVICE ACCOUNT**.
3. On the **Create service account** page, enter the required information, and then select **CREATE AND CONTINUE**.
4. On the **Grant this service account access to project** page, click the **Select a role** drop-down menu and select the required roles. Click **+ADD ANOTHER ROLE** if you want to add more roles.

Each account (personal or service) has various roles defining the management of the project. Grant the following roles to this service account:

- Compute Admin
- Storage Admin
- Cloud Build Editor
- Service Account User
- Cloud Datastore User
- Cloud KMS Crypto Operator

The Cloud KMS Crypto Operator requires the following permissions:

- cloudkms.cryptoKeys.get
- cloudkms.cryptoKeys.list
- cloudkms.keyRings.get

- cloudkms.keyRings.list

Note:

Enable all the APIs to get the complete list of roles available while creating a new service account.

5. Click **CONTINUE**
6. On the **Grant users access to this service account** page, add users or groups to grant them access to perform actions in this service account.
7. Click **DONE**.
8. Navigate to the IAM main console.
9. Identify the service account created.
10. Validate the roles are assigned successfully.

Considerations:

When creating the service account, consider the following:

- The steps **Grant this service account access to project** and **Grant users access to this service account** are optional. If you choose to skip these optional configuration steps, the newly created service account does not display in the **IAM & Admin > IAM** page.
- To display roles associated with a service account, add the roles without skipping the optional steps. This process ensures that roles appear for the configured service account.

Citrix Cloud Service Account key The Citrix Cloud Service Account key is required for creating a connection in Citrix DaaS. The key is contained in a credential file (.json). The file is automatically downloaded and saved to the **Downloads** folder after you create the key. When you create the key, be sure to set the key type to JSON. Otherwise, the Citrix Full Configuration interface cannot parse it.

To create a Service Account Key, navigate to **IAM & Admin > Service accounts** and click the email address of the Citrix Cloud Service Account. Switch to the **Keys** tab and select **Add Key > Create new key**. Make sure to select **JSON** as the key type.

Tip:

Create keys using the **Service accounts** page in the Google Cloud console. We recommend that you change keys regularly for security purposes. You can provide new keys to the Citrix Virtual Apps and Desktops application by editing an existing Google Cloud connection.

Add roles to the Citrix Cloud Service Account To add roles to the Citrix Cloud Service Account:

1. In the Google Cloud console, navigate to **IAM & Admin > IAM**.
2. On the **IAM > PERMISSIONS** page, locate the service account you created, identifiable with an email address.

For example, `<my-service-account>@<project-id>.iam.gserviceaccount.com`
3. Select the pencil icon to edit the access to the principal of the service account.
4. On the **Edit access to “project-id”** page for the selected principal option, select **ADD ANOTHER ROLE** to add the required roles to your service account one by one and then select **SAVE**.

Add roles to the Cloud Compute Service Account To add roles to the Cloud Compute Service Account:

1. In the Google Cloud console, navigate to **IAM & Admin > IAM**.
2. On the **IAM** page, locate the Cloud Compute Service Account, identifiable with an email address that begins with the **Project ID** and the word **compute**.

For example, `<project-id>-compute@developer.gserviceaccount.com`
3. Select the pencil icon to edit the Cloud Build account roles.
4. On the **Edit access to “project-id”** page for the selected principal option, select **ADD ANOTHER ROLE** to add the required roles to your Cloud Build service account one by one and then select **SAVE**.

Note:

Enable all the APIs to get the complete list of roles.

Storage permissions and bucket management

Citrix Virtual Apps and Desktops improves the process of reporting cloud build failures for the [Google Cloud service](#). This service runs builds on the Google Cloud. Citrix Virtual Apps and Desktops creates a storage bucket named `citrix-mcs-cloud-build-logs-{ region } -{ 5 random characters }` where the Google Cloud services captures build log information. An option is set on this bucket that deletes the contents after a period of 30 days. This process requires that the service account used for the connection has Google Cloud permissions set to `storage.buckets.update`. If the service account does not have this permission, Citrix Virtual Apps and Desktops ignores errors and proceeds with the catalog creation process. Without this permission, the size of the build logs increases and requires manual cleanup.

Enable private Google access

When a VM lacks an external IP address assigned to its network interface, packets are only sent to other internal IP addresses destinations. When you enable private access, the VM connects to the set of external IP addresses used by the Google API and associated services.

Note:

Whether private Google access is enabled, all VMs that are with and without public IP addresses, must be able to access Google Public APIs, especially if third-party networking appliances have been installed in the environment.

To ensure that a VM in your subnet can access the Google APIs without a public IP address for MCS provisioning:

1. In Google Cloud, access the **VPC network configuration**.
2. In the Subnet details screen, turn on **Private Google access**.

The screenshot shows the Google Cloud Platform console interface. At the top, there is a blue header with the Google Cloud Platform logo and a navigation menu. Below the header, the main content area is divided into two columns. The left column contains a sidebar with various network-related options: VPC networks, External IP addresses, Firewall, Routes, VPC network peering, Shared VPC, Serverless VPC access, and Packet mirroring. The right column displays the 'Subnet details' for a subnet named 'default'. The details include: VPC Network (default), Region (us-east1), IP address range (10.142.0.0/20), Gateway (10.142.0.1), Private Google access (Off), Flow logs (Off), and Equivalent REST API endpoint. The 'Private Google access' setting is highlighted with a red rectangular box.

For more information, see [Configuring Private Google Access](#).

Important:

If your network is configured to prevent VM access to the Internet, ensure that your organization assumes the risks associated with enabling Private Google access for the subnet to which the VM is connected.

Where to go next

- [Install core components](#)
- [Install VDAs](#)
- [Create a site](#)
- For creating and managing a connection in Google Cloud environments, see [Connection to Google cloud environments](#)

More information

- [Create and manage connections and resources](#)
- [Create machine catalogs](#)

HPE Moonshot virtualization environments

April 16, 2024

Citrix Virtual Apps and Desktops manages your HPE Moonshot workloads through a Citrix-managed HPE Moonshot plug-in present. With this plug-in, you can create connections to your HPE Moonshot chassis, create catalogs, and power manage machines in the catalog.

Requirement

Install the Citrix-managed HPE Moonshot plug-in on the Delivery Controller.

Note:

- If both Citrix-managed and HPE-managed HPE Moonshot plug-ins are installed, then the Delivery Controller uses the Citrix-managed HPE Moonshot plug-in.
- If both Citrix-managed and HPE-managed HPE Moonshot plug-ins are installed, and you want to use HPE-managed Moonshot plug-in, then uninstall Citrix-managed HPE Moonshot plug-in, and update the `RegisterPlugin` cache.

Install the Citrix-managed HPE Moonshot plug-in

To install the Citrix-managed HPE Moonshot plug-in, do the following:

1. Install `E:\x64\Citrix Desktop Delivery Controller\MoonshotPlugin.msi`.
`E:\` is the ISO.
2. Open the PowerShell as an Administrator and run the following command.

```
1 C:\Program Files\Common Files\Citrix\HCLPlugins> .\RegisterPlugins
.exe -pluginsroot .\CitrixMachineCreation\v1.0.0.0\
2 <!--NeedCopy-->
```

3. After the plug-in registration is successful, restart the following services from the **Task Manager**:
 - a) CitrixBrokerService
 - b) CitrixHostService

- c) CitrixMachineCreationService
4. Run `Get-HypervisorPlugins` to check if the plug-in is installed on the Delivery controller. The **DisplayName** field in the output must show as **HPE Moonshot**.

Uninstall Citrix-managed HPE Moonshot plug-in and update the RegisterPlugin cache

If both Citrix-managed and HPE-managed HPE Moonshot plug-ins are installed, and you want to use HPE-managed Moonshot plug-in, then you must uninstall Citrix-managed HPE Moonshot plug-in and update the `RegisterPlugin` cache. To do so:

1. Uninstall Citrix-managed HPE Moonshot plug-in.
2. Open the PowerShell as an Administrator and run the following command:

```
1 cd `C:\Program Files\Common Files\Citrix\HCLPlugins\  
2 C:\Program Files\Common Files\Citrix\HCLPlugins> .\RegisterPlugins  
   .exe -PluginsRoot ` C:\Program Files\Common Files\Citrix\  
   HCLPlugins\ManagedMachine\v2.5.0.0\  
3 <!--NeedCopy-->
```

3. After the plug-in registration is successful, restart the following services from the **Task Manager**:
 - a) CitrixBrokerService
 - b) CitrixHostService
 - c) CitrixMachineCreationService
4. Run `Get-HypervisorPlugins` to check if the plug-in is installed on the Delivery controller. The **DisplayName** field in the output must show as **HPE Moonshot Machine Manager**.

Key steps

1. Set up your HPE environments.
2. Create a connection to the HPE Moonshot chassis.
3. Create a machine catalog.

Note:

Before creating a catalog, ensure to have one or more HPE Moonshot cartridge nodes and install VDAs on those nodes. You can consider the HPE Moonshot chassis as the hypervisor and the cartridge nodes as VMs.

4. Create a delivery group.
5. Migrate the rest of unmanaged HPE Moonshot nodes to the managed catalog or delivery group.

Where to go next

- [Install core components](#)
- [Install VDAs](#)
- [Create a site](#)
- For creating and managing a connection in HPE Moonshot, see [Connection to HPE Moonshot](#)

More information

- [Create and manage connections and resources](#)
- [Create machine catalogs](#)

Microsoft Azure Resource Manager cloud environments

July 28, 2023

When using the Microsoft Azure Resource Manager to provision virtual machines in your Citrix Virtual Apps and Desktops deployment, get familiar with the following:

- Azure Active Directory: <https://docs.microsoft.com/en-in/azure/active-directory/fundamentals/active-directory-what-is/>
- Consent framework: <https://docs.microsoft.com/en-us/azure/active-directory/manage-apps/plan-an-application-integration>
- Service principal: <https://docs.microsoft.com/en-us/azure/active-directory/develop/app-objects-and-service-principals/>

To set up your Microsoft Azure Resource Manager, see [Prepare to install](#).

Where to go next

- [Install core components](#)
- [Install VDAs](#)
- [Create a site](#)
- For creating and managing a connection in Azure environments, see [Connection to Microsoft Azure](#)

More information

- [Create and manage connections and resources](#)

- [Create machine catalogs](#)
- [CTX219211](#): Set up a Microsoft Azure Active Directory account
- [CTX219243](#): Grant XenApp and XenDesktop access to your Azure subscription
- [CTX219271](#): Deploy hybrid cloud using site-to-site VPN

Microsoft System Center Configuration Manager environments

June 26, 2023

Sites using Microsoft System Center Configuration Manager (Configuration Manager) to manage access to applications and desktops can extend that use to Citrix Virtual Apps and Desktops using these options:

- [Install VDAs using SCCM](#).
- **Configuration Manager Wake Proxy feature:** The Remote PC Access Wake on LAN feature is supported with Configuration Manager. For details, see [Wake on LAN - SCCM integrated](#).
- **Citrix Virtual Apps and Desktops properties:** Properties enable you to identify Citrix Virtual Desktops for management through Configuration Manager. (In some versions, Configuration Manager uses the former name of Citrix Virtual Apps and Desktops: XenApp and XenDesktop.)

Properties

Properties are available to Microsoft System Center Configuration Manager to manage virtual desktops.

Boolean properties displayed in Configuration Manager appear as 1 or 0, not true or false.

The properties are available for the `Citrix_virtualDesktopInfo` class in the `Root\Citrix\DesktopInformation` namespace. Property names come from the Windows Management Instrumentation (WMI) provider.

Property	Description
<code>AssignmentType</code>	Sets the value of <code>IsAssigned</code> . Valid values are: <code>ClientIP</code> , <code>ClientName</code> , <code>None</code> , and <code>User</code> (sets <code>IsAssigned</code> to <code>True</code>)
<code>BrokerSiteName</code>	Returns the same value as <code>HostIdentifier</code>
<code>DesktopCatalogName</code>	Machine catalog associated with the desktop.
<code>DesktopGroupName</code>	Delivery group associated with the desktop.

Property	Description
<code>HostIdentifier</code>	Returns the same value as <code>BrokerSiteName</code> .
<code>IsAssigned</code>	<code>True</code> to assign the desktop to a user, set to <code>False</code> for a random desktop
<code>IsMasterImage</code>	Allows decisions about the environment. For example, install applications on the image and not on the provisioned machines. Valid values are: <code>True</code> on a VM that is used as an image. This value is set during installation based on a selection, or cleared on a VM that is provisioned from that image.
<code>IsVirtualMachine</code>	<code>True</code> for a virtual machine, <code>false</code> for a physical machine.
<code>OSChangesPersist</code>	<code>False</code> if the desktop operating system image is reset to a clean state every time it is restarted; otherwise, <code>true</code> .
<code>PersistentDataLocation</code>	The location where Configuration Manager stores persistent data. This is not accessible to users.
<code>BrokerSiteName, DesktopCatalogName, DesktopGroupName, HostIdentifier</code>	Determined when the desktop registers with the Controller. They are null for a desktop that has not fully registered.

To collect the properties, run a hardware inventory in Configuration Manager. To view the properties, use the Configuration Manager Resource Explorer. In these instances, the names include spaces or vary slightly from the property names. For example, `BrokerSiteName` appears as `Broker Site Name`.

- Configure Configuration Manager to collect Citrix WMI properties from the Citrix VDA
- Create query-based device collections using Citrix WMI properties
- Create global conditions based on Citrix WMI properties
- Use global conditions to define application deployment type requirements

You can also use Microsoft properties in the Microsoft class `CCM_DesktopMachine` in the `Root\ccm_vdi` namespace. For more information, see the Microsoft documentation.

Microsoft System Center Virtual Machine Manager virtualization environments

September 20, 2023

Follow this guidance if you use Hyper-V with Microsoft System Center Virtual Machine Manager (VMM) to provide virtual machines.

This release supports the VMM versions listed in [System requirements](#).

Note:

Mixed Hyper-V clusters (containing servers running different Hyper-V versions) are not supported.

You can use Citrix Provisioning (formerly Provisioning Services) and Machine Creation Services to provision:

- Generation 1 supported Desktop or Server OS VMs.
- Generation 2 supported Desktop or Server OS VMs, including Secure Boot support.

Install and configure a hypervisor

Important:

All Delivery Controllers must be in the same forest as the VMM servers.

1. Install Microsoft Hyper-V server and VMM on your servers.
2. Install the System Center Virtual Machine Manager console on all Controllers. The console version must match the management server version. Although an earlier console can connect to the management server, provisioning VDAs fails if the versions differ.
3. Verify the following account information:

The account you use to specify hosts in Studio is a VMM administrator or VMM delegated administrator for the relevant Hyper-V machines. If this account only has the delegated administrator role in VMM, the storage data is not listed in Studio during the host creation process.

The user account used for Studio integration must also be a member of the administrators local security group on each Hyper-V server. This configuration supports VM life cycle management, such as VM creation, update, and deletion.

Installing a Controller on a server running Hyper-V is not supported.

In large deployments where a single SCVMM manages multiple clusters in different data centers, you can limit the host groups scope of delegated admins.

To limit the host groups scope, use the Delegated Admin role in Microsoft System Center Virtual Machine Manager (VMM) console:

1. On **Create User Roles Wizard**, select Fabric Administrator (Delegated Administrator) as a user role.
2. In **Members**, add the user account in the Active Directory that you want to use as delegated admin.
3. In **Scope**, select the host groups you want the delegated admin to have access to.
4. Create a new **Run As Account** using delegated admin user credentials. Use these credentials to create a hypervisor connection later. Do not use the main administrator role accounts.

Provision Azure Stack HCI through SCVMM

Azure Stack HCI is a hyper-converged infrastructure (HCI) cluster solution that hosts virtualized Windows and Linux workloads and their storage in a hybrid, on-premises environment.

Azure hybrid services enhance the cluster with capabilities such as cloud-based monitoring, site recovery, and VM backups. You can also have a central view of all your Azure Stack HCI deployments in the Azure portal.

Integrate Azure Stack HCI with SCVMM

To integrate Azure Stack HCI with SCVMM, you need to first create an Azure Stack HCI cluster, and then integrate that cluster with SCVMM.

1. To create the Azure Stack HCI cluster, see the Microsoft document [Connect Azure Stack HCI to Azure](#).
2. To integrate Azure Stack HCI cluster with SCVMM, do the following:
 - a) Log in to the machine that is prepared to host the SCVMM server and install SCVMM 2019 UR3 or later.

Note:

Install SCVMM 2019 UR3 or later Administrator Console on all controllers.

- b) In the **Settings** page of the VMM console, create a run as account.

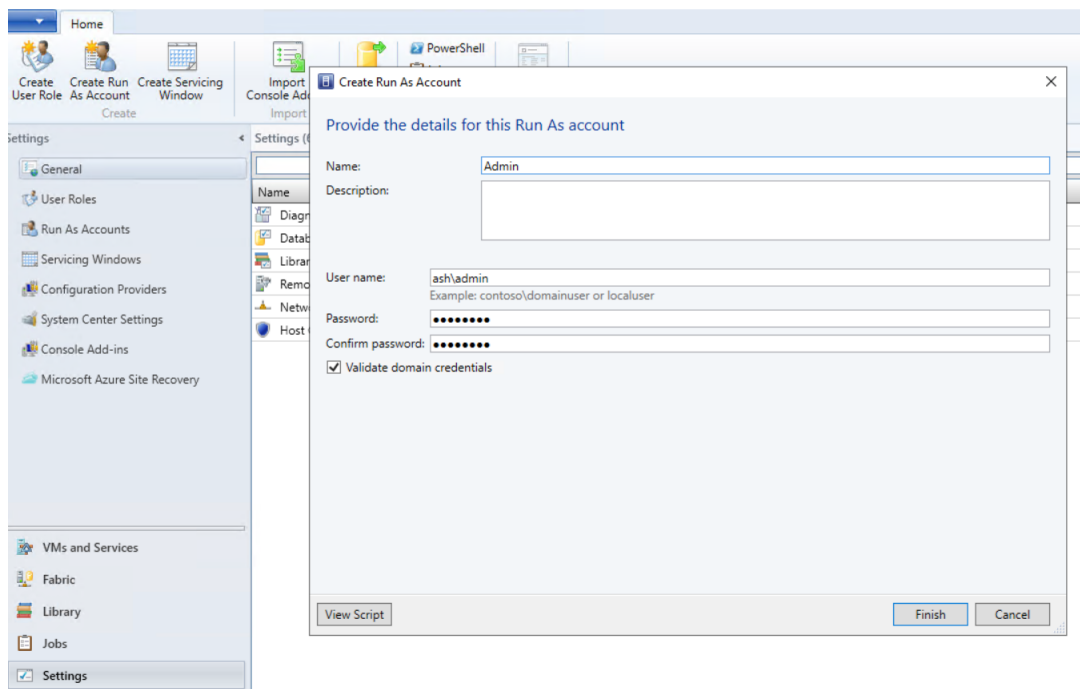

- c) Run the following PowerShell commands with administrative privileges in the SCVMM server to add the Azure Stack HCI cluster as a host:

```

1 $runAsAccountName = 'Admin'
2 $runAsAccount = Get-SCRunAsAccount -Name $runAsAccountName
3 $hostGroupName = 'All Hosts'
4 $hostGroup = Get-SCVMHostGroup -Name $hostGroupName
5 $hostCluster = 'FQDN of Azure Stack HCI cluster'
6 Add-SCVMHostCluster -Name $hostCluster -RunAsynchronously -
  VMHostGroup
7 $hostGroup -Credential $runAsAccount -RemoteConnectEnabled
  $true
8 <!--NeedCopy-->

```

- d) You can now see the Azure Stack HCI cluster along with the nodes in the VMM console.

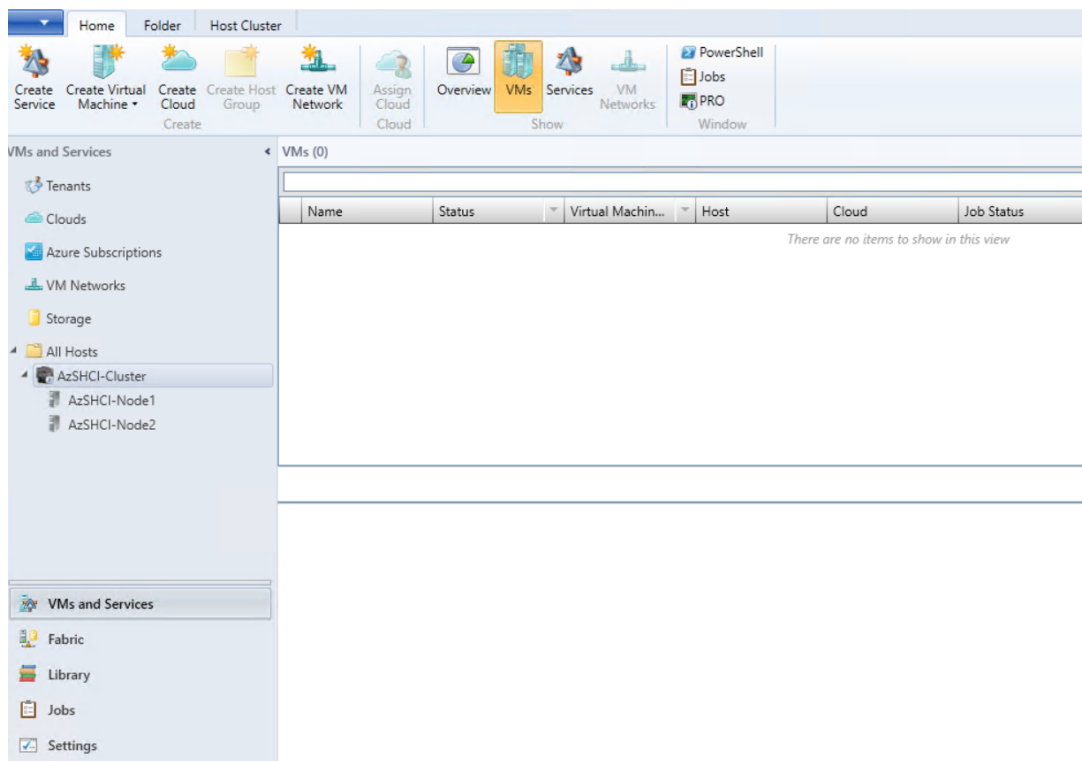

e) Create the SCVMM hosting connection in Web Studio.

Where to go next

- [Install core components](#)
- [Install VDAs](#)
- [Create a site](#)
- For creating and managing a connection in SCVMM, see [Connection to Microsoft System Center Virtual Machine Manager](#)

More information

- [Create and manage connections and resources](#)
- [Create machine catalogs](#)

Nutanix virtualization environments

July 28, 2023

Follow this guidance when using Nutanix Acropolis to provide virtual machines in your Citrix Virtual Apps and Desktops deployment. The setup process includes the following tasks:

- Install and register the Nutanix plug-in in your Citrix Virtual Apps and Desktops environment.
- Create a connection to the Nutanix Acropolis hypervisor.
- Create a machine catalog that uses a snapshot of a master image you created on the Nutanix hypervisor.

For more information, see the Nutanix Acropolis MCS plug-in Installation Guide, available at the [Nutanix Support Portal](#).

Install and register the Nutanix plug-in

Complete the following procedure to install and register the Nutanix plug-in on all your Delivery Controllers. Use Citrix Studio to create a connection to Nutanix. Then, create a machine catalog that uses a snapshot of a master image you created in the Nutanix environment.

Tip:

We recommend that you stop and then restart the Citrix Host Service, the Citrix Broker Service, and the Machine Creation Services when you install or update the Nutanix plug-in.

For information about installing the Nutanix plug-in, see the [Nutanix Documentation site](#).

Where to go next

- [Install core components](#)
- [Install VDAs](#)
- [Create a site](#)
- For creating and managing a connection in Nutanix environments, see [Connection to Nutanix](#)

More information

- [Create and manage connections and resources](#)
- [Create machine catalogs](#)

Nutanix cloud and partner solutions

July 28, 2023

Citrix Virtual Apps and Desktops supports the following Nutanix cloud and partner solution:

- Nutanix Cloud Clusters on AWS

Nutanix Cloud Clusters on AWS

Citrix Virtual Apps and Desktops supports Nutanix Cloud Clusters on AWS. Nutanix clusters simplify how applications are run on private or multiple public clouds. For more information on Nutanix Cloud Clusters on AWS, see [Nutanix Cloud Clusters on AWS Deployment and User Guide](#).

Tip:

This support provides the same functionality as a Nutanix on-premises cluster. Only a single cluster is supported, *Prism Element*. For more information, see [here](#).

Requirements

You need the following to use Nutanix Clusters on AWS:

- A Nutanix account.
- An AWS account with the following permissions:
 - IAMFullAccess
 - AWSConfigRole
 - AWSCloudFormationFullAccess

Create a Nutanix Cluster

To create a Nutanix Cluster:

1. Log in to your Nutanix account.
2. Locate the **Nutanix cluster** option, and click **Launch**. The **Nutanix Console** opens. For more information, see [Get Started with Nutanix Cluster on AWS](#).
3. Choose to create a **new VPC**.

The cluster creation process may fail with the following errors:

- Cluster failed to create within a given time. Deleting cluster.
- Host Nutanix Cluster - Node XXXXXXXXXXXX: Instance i-xxxxxxxxxxxxx: disable network **interface** source/dest check error.
- Host Nutanix Cluster - Node XXXXXXXXXXXX: Unable to obtain instance i-xxxxxxxxxxxxx network **interface** info.

If the cluster failed to create:

- Try to recreate one in a different region.
- Make sure to delete the Nutanix CloudFormation Stack (CFS) before retrying.

In addition to other resources, the Nutanix CFS creates:

- 1 VPC named *Nutanix Cluster xxxxxxxxxxxxxx* 10.0.0.0/16
- 2 subnets 10.0.128.0/24 and 10.0.129.0/24
- 1 Internet gateway
- 1 NAT gateway

Once the cluster is created, retrieve the address of the **Nutanix Prism**:

1. Go to the **Nutanix Console**.
2. In the upper right on the console, mouse over the link **Launch Prism Element** and copy the URL.

Where to go next

- [Install core components](#)
- [Install VDAs](#)
- [Create a site](#)
- For creating and managing a connection of Nutanix cloud and partner solutions, see [Connection to Nutanix cloud and partner solutions](#)

More information

- [Create and manage connections and resources](#)
- [Create machine catalogs](#)

VMware virtualization environments

July 28, 2023

Follow this guidance if you use VMware to provide virtual machines.

Install vCenter Server and the appropriate management tools. (No support is provided for vSphere vCenter Linked Mode operation.)

If you plan to use MCS, do not disable the Datastore Browser feature in vCenter Server (described in <https://kb.vmware.com/s/article/2101567>). When you disable this feature, MCS does not work correctly.

Where to go next

- [Install core components](#)
- [Install VDAs](#)
- [Create a site](#)
- For creating and managing a connection in VMware environments, see [Connection to VMware](#)

More information

- [Create and manage connections and resources](#)
- [Create machine catalogs](#)

VMware cloud and partner solutions

March 8, 2024

Citrix Virtual Apps and Desktops supports the following VMware cloud and partner solutions:

- Azure VMware Solution (AVS)
- Google Cloud VMware Engine
- VMware Cloud on Amazon Web Services (AWS)

Azure VMware Solution (AVS) integration

Citrix Virtual Apps and Desktop service supports [AVS](#). AVS provides cloud infrastructure containing vSphere clusters created by Azure infrastructure. Leverage the Citrix Virtual Apps and Desktop Service to use AVS for provisioning your VDA workload in the same way that you would using vSphere in on-premises environments.

Set up the AVS cluster

To enable the Citrix Virtual Apps and Desktop Service to use AVS, perform the following steps in Azure:

- Request a host quota
- Register the Microsoft.AVS resource provider
- Network Checklist
- Create an Azure VMware Solution private cloud
- Access an Azure VMware Solution private cloud
- Configure networking for your VMware private cloud in Azure
- Configure DHCP for Azure VMware Solution
- Add a network segment in Azure VMware Solution
- Verify Azure VMware Solution environment

Request host quota for Azure Enterprise Agreement customers In the Azure portal's **Help + Support** page select **New support request**, and include the following information:

- Issue type:Technical
- Subscription:Select your subscription
- Service:All services > Azure VMware Solution
- Resource:General question
- Summary:Need capacity
- Problem type:Capacity Management Issues
- Problem subtype:Customer Request for Additional Host Quota/Capacity

In the **Description** of the support ticket, include the following information in the **Details** tab:

- POC or Production
- Region Name
- Number of hosts
- Any other details

Note:

AVS requires a minimum of three hosts, and recommends that you use redundancy of N+1 hosts.

After specifying details for the support ticket, select **Review + Create** to submit the request to Azure.

Register the Microsoft.AVS resource provider After requesting the host quota, register the resource provider:

1. Sign in to the Azure portal.
2. On the Azure portal menu, select **All services**.
3. In the **All services** menu, enter the subscription, and select **Subscriptions**.
4. Select the subscription from the subscription list.
5. Select **Resource providers** and enter **Microsoft.AVS** in the search bar.
6. If the resource provider is not registered, select **Register**.

Networking considerations AVS offers networking services requiring specific network address ranges and firewall ports. See [Networking planning checklist for Azure VMware Solution](#) for more information.

Create an Azure VMware Solution private cloud After considering network requirements for your environment, create a ASV private cloud:

1. Sign in to the Azure portal.
2. Select **Create a new resource**.
3. In the **Search the Marketplace** text box type, *Azure VMware Solution*, and select **Azure VMware Solution** from the list.

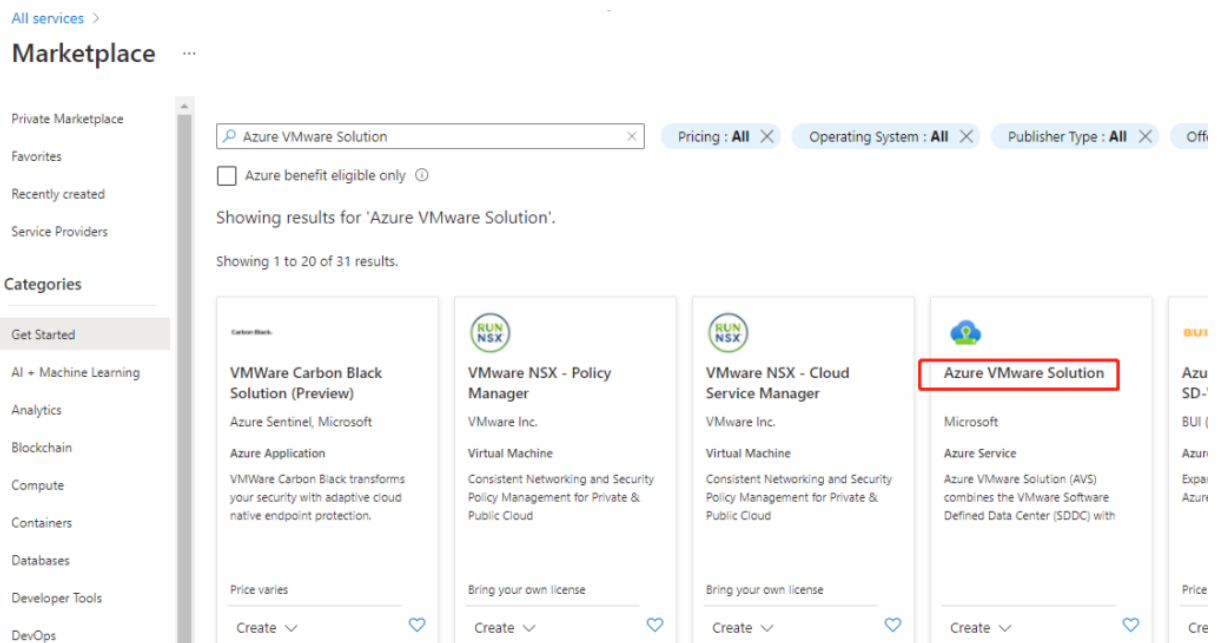

image

In the **Azure VMware Solution** window:

1. Select **Create**.
2. Click the **Basics** tab.
3. Enter values for the fields, using the information in the table below:

Field	Value
Subscription	Select the subscription you plan to use for the deployment. All resources in an Azure subscription are billed together.

Field	Value
Resource group	Select the resource group for your private cloud. An Azure resource group is a logical container into which Azure resources are deployed and managed. Alternatively, you can create a new resource group for your private cloud.
Location	Select a location, such as east us. This is the region you defined during the planning phase.
Resource name	Provide the name of your Azure VMware Solution private cloud.
SKU	Select AV36.
Hosts	Shows the number of hosts allocated for the private cloud cluster. The default value is 3, which can be raised or lowered after deployment.
Address block	Provide an IP address block for the private cloud. The CIDR represents the private cloud management network and will be used for the cluster management services, such as vCenter Server and NSX-T Manager. Use /22 address space, for example, 10.175.0.0/22. The address should be unique and not overlap with other Azure Virtual Networks as well as with on-premises networks.
Virtual Network	Leave this blank because the Azure VMware Solution ExpressRoute circuit is established as a post-deployment step.

In the **Create a private cloud** screen:

1. In the **Location** field, select the region that has the AVS; the resource group region is the same as the AVS region.
2. In the **SKU** field, select **AV36 Node**.
3. Specify an IP address in the **Address Block** field. For example, 10.15.0.0/22.
4. Select **Review + Create**.
5. After reviewing the information, click **Create**.

Create a private cloud ...

* Basics Tags Review + create

Azure settings

Subscription * ⓘ

cc-lab-xac-cp1-ca-aakash.mathai@citrix.com

Resource group * ⓘ

AVS

[Create new](#)

Location * ⓘ

(Asia Pacific) Southeast Asia

General

Resource name * ⓘ

AVSPcloud

SKU * ⓘ

AV36 Node

ESXi hosts * ⓘ

3

i There is no metering for the selected subscription, region, and SKU. No cost data to display.

Address block * ⓘ

10.15.0.0/22

Virtual Network

[Create new](#)

Only Virtual Networks with a valid subnet with the name "GatewaySubnet" are available for selection. For details about adding subnet in a virtual network, refer to details [here](#)

Tip:

Creating a private cloud can take 3-4 hours. Adding a single host to cluster can take 30-45 minutes.

Verify that the deployment was successful. Navigate to the resource group you created and select your private cloud. Once the **Status** is **Succeeded** the deployment is complete.

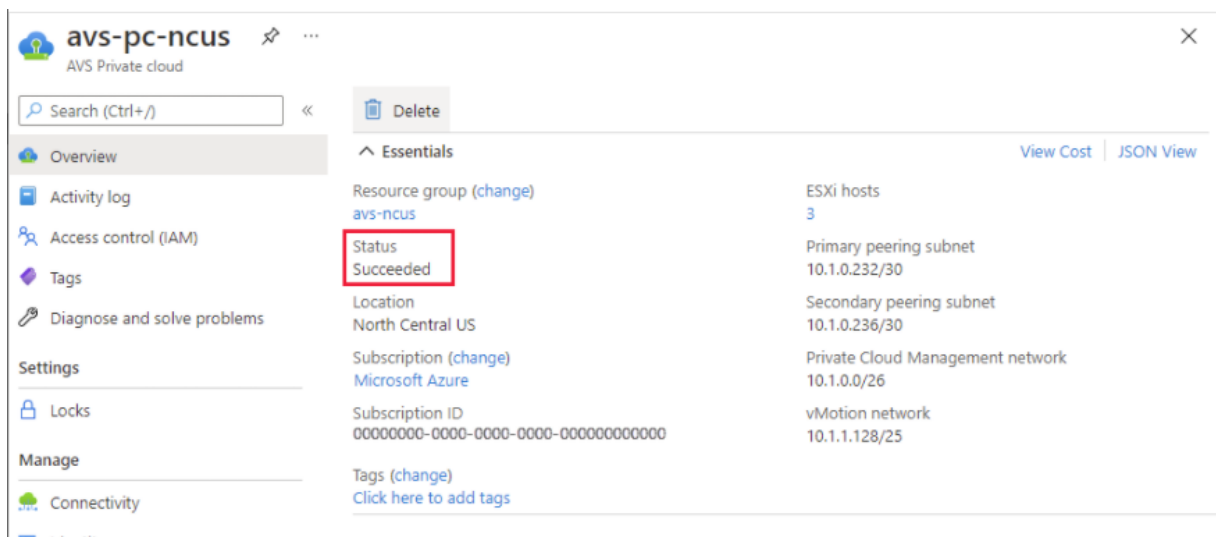

Access an Azure VMware Solution private cloud Once you have created a private cloud, create a Windows VM and connect to the local vCenter of your private cloud.

Create a new Windows virtual machine

1. In the resource group, select **+ Add** then search and select **Microsoft Windows 10/2016/2019**.
2. Click **Create**.
3. Enter the required information, then select **Review + Create**.
4. Once validation passes, select **Create** to start the virtual machine creation process.

Connect to the local vCenter of your private cloud

1. Sign in to **vSphere Client with VMware vCenter SSO** as a cloud administrator.

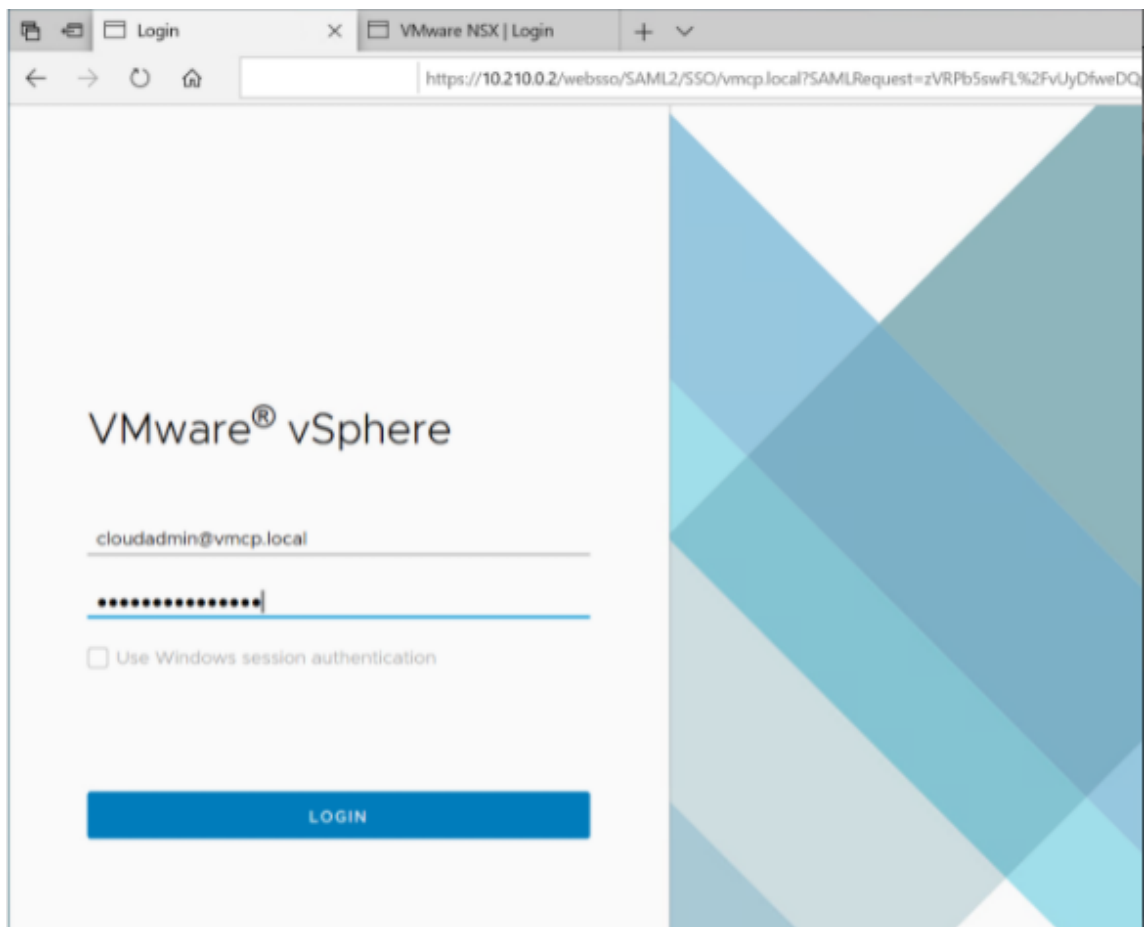

2. In the Azure portal, select your private cloud, and then **Manage> Identity**.

The URLs and user credentials for private cloud vCenter and NSX-T Manager appear:

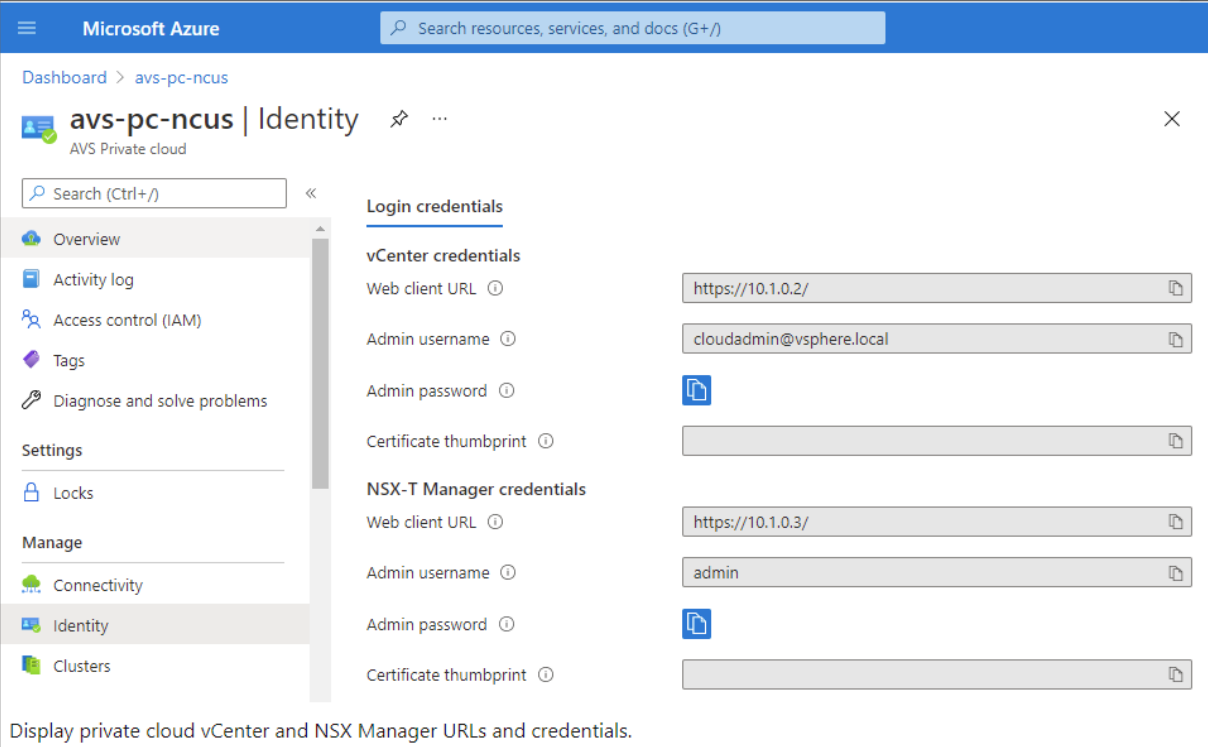

Microsoft Azure

Dashboard > avs-pc-ncus

avs-pc-ncus | Identity

AVS Private cloud

Search (Ctrl+ /)

Overview

Activity log

Access control (IAM)

Tags

Diagnose and solve problems

Settings

Locks

Manage

Connectivity

Identity

Clusters

Login credentials

vCenter credentials

Web client URL

Admin username

Admin password

Certificate thumbprint

NSX-T Manager credentials

Web client URL

Admin username

Admin password

Certificate thumbprint

Display private cloud vCenter and NSX Manager URLs and credentials.

After confirming URLs and user credentials:

1. Navigate to the VM you created in the preceding step and connect to the virtual machine.
2. In the Windows VM, open a browser and navigate to the vCenter and NSX-T Manager URLs in two browser tabs. In the vCenter tab, enter the `cloudadmin@vmcp.local` user credentials from the previous step.

Configure networking for your VMware private cloud in Azure After accessing an ASV private cloud, configure networking by creating a virtual network and gateway.

Create a virtual network

1. Sign in to the Azure portal.
2. Navigate to the previously created resource group.
3. Select **+ Add** to define a new resource.
4. In the **Search the Marketplace** text box, type *virtual network*. Find the virtual network resource and select it.
5. On the **Virtual Network** page, select **Create** to set up the virtual network for your private cloud.
6. On the **Create Virtual Network** page, enter the details for your virtual network.
7. On the **Basics** tab, enter a name for the virtual network, select the appropriate region, and click **Next : IP Addresses**.
8. On the **IP Addresses** tab, under IPv4 address space, enter the previously created address.

Important:

Use an address that does not overlap with the address space you used when you created your private cloud.

After entering the address space:

1. Select **+ Add subnet**.
2. On the **Add subnet** page, give the subnet a name and appropriate address range.
3. Click **Add**.
4. Select **Review + create**.
5. Verify the information and click **Create**. Once the deployment is complete, the virtual network appears in the resource group.

Create a virtual network gateway After creating a virtual network, create a virtual network gateway.

1. In your resource group, select **+ Add** to add a new resource.
2. In the **Search the Marketplace** text box, type *virtual network gateway*. Find the virtual network resource and select it.
3. On the **Virtual Network gateway** page, click **Create**.
4. On the **Basics** tab in the **Create virtual network gateway** page, provide values for the fields.
5. Click **Review + create**.

Home > Resource groups > AVS > Create a resource > Virtual network gateway >

Create virtual network gateway

Project details

Select the subscription to manage deployed resources and costs. Use resource groups like folders to organize and manage all your resources.

Subscription * cc-lab-xac-cp1-ca-aakash.mathai@citrix.com

Resource group ⓘ AVS (derived from virtual network's resource group)

Instance details

Name * AVS_gateway ✓

Region * Southeast Asia

Gateway type * ⓘ VPN ExpressRoute

SKU * ⓘ Standard

Virtual network * ⓘ AVS_vNet

[Create virtual network](#)

ⓘ Only virtual networks in the currently selected subscription and region are listed.

Gateway subnet address range * ⓘ 10.16.1.0/24 ✓

10.16.1.0 - 10.16.1.255 (256 addresses)

Public IP address

Public IP address * ⓘ Create new Use existing

Public IP address name * AVSprivateCloudgatewayIP ✓

Public IP address SKU Basic

Assignment Dynamic Static

After reviewing the virtual network gateway configuration, click **Create** to deploy your virtual network gateway.

Once the deployment completes, connect your **ExpressRoute** connection to the virtual network gateway containing your Azure AVS private cloud.

Connect ExpressRoute to the virtual network gateway After deploying a virtual network gateway, add a connection between it and your Azure AVS private cloud:

1. Request an ExpressRoute authorization key.

2. In the Azure portal, navigate to the **Azure VMware Solution private cloud**. Select **Manage > Connectivity > ExpressRoute** and then select **+ Request an authorization key**.

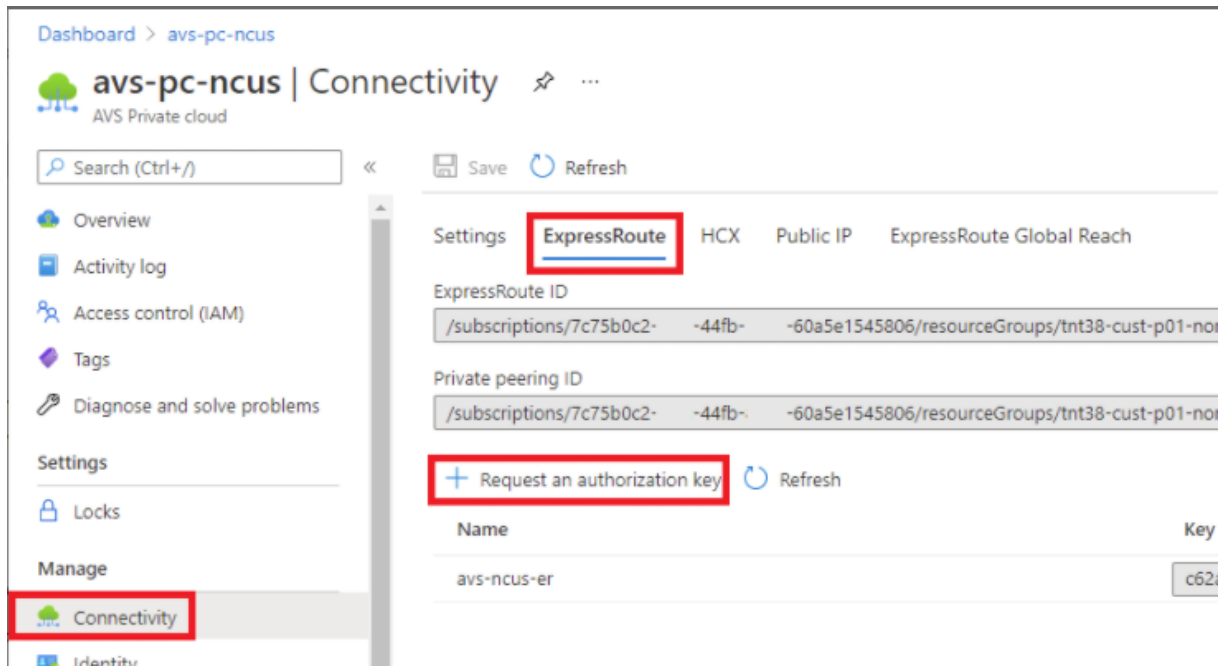

After requesting an authorization key:

1. Enter a name for the key and click **Create**. It may take about 30 seconds to create the key. Once created, the new key appears in the list of authorization keys for the private cloud.
2. Copy the **authorization key** and **ExpressRoute ID**. You'll need them to complete the peering process. The authorization key disappears after some time, so copy it as soon as it appears.
3. Navigate to the **virtual network gateway** you plan to use and select **Connections > + Add**.
4. On the **Add connection** page, provide values for the fields, and select **OK**.

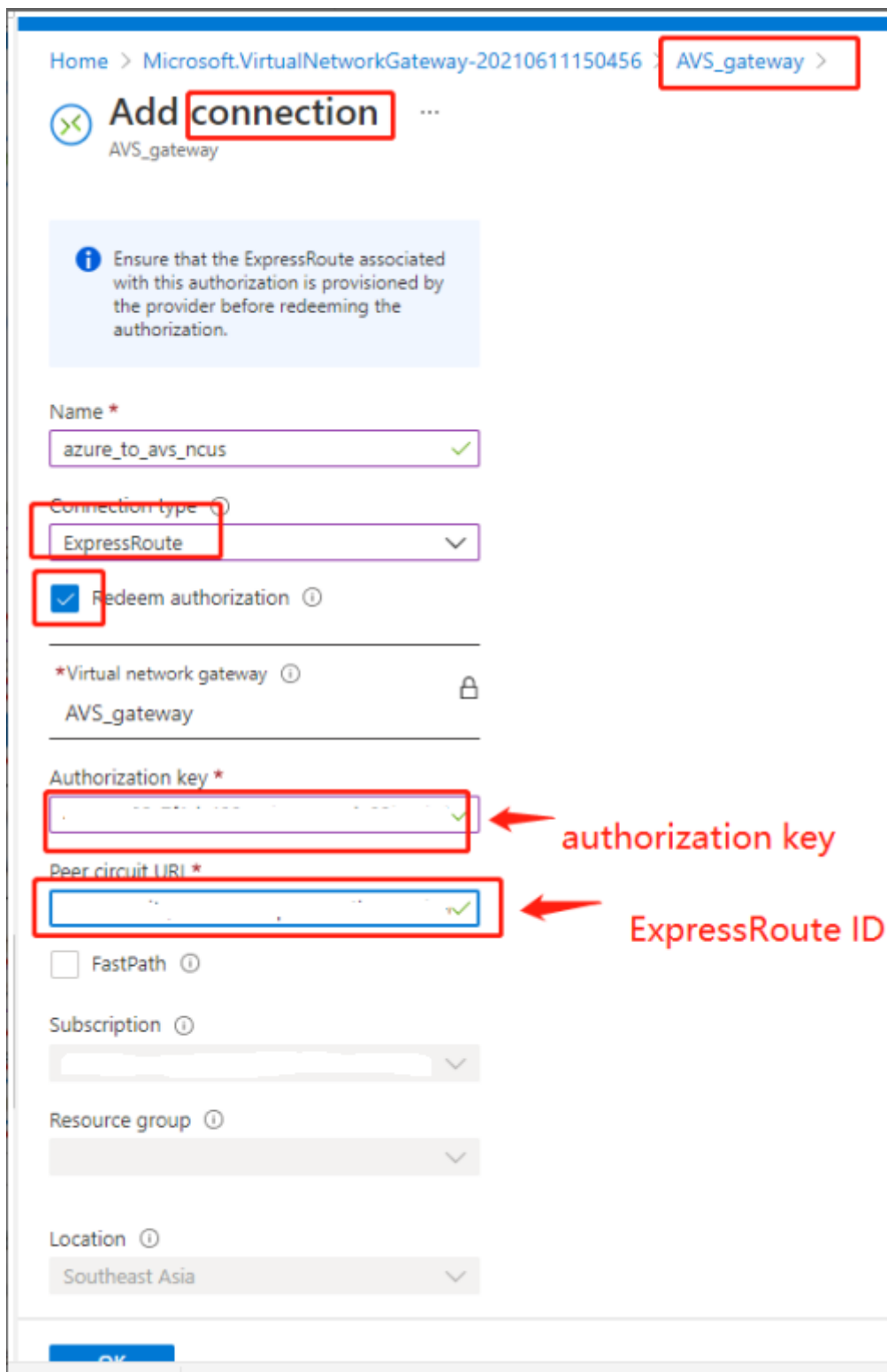

The connection is established between your ExpressRoute circuit and your virtual network:

+ Add Refresh

Search connections

Name	Status	Connection type	Peer
azure_to_aws_ncus	Succeeded	ExpressRoute	tnt47-cust-p01-southeastasia-er

Configure DHCP for Azure VMware Solution After connecting ExpressRoute to the virtual gateway, configure DHCP.

Use NSX-T to host your DHCP server In NSX-T Manager:

1. Select **Networking > DHCP**, and then select **Add Server**.
2. Select **DHCP** for the **Server Type**, provide the server name and IP address.
3. Click **Save**.
4. Select **Tier 1 Gateways**, select the vertical ellipsis on the Tier-1 gateway, and then select **Edit**.
5. Select **No IP Allocation Set** to add a subnet.
6. Select **DHCP Local Server** for the **Type**.
7. For the **DHCP Server**, select **Default DHCP**, and then click **Save**.
8. Click **Save** again and then select **Close Editing**.

ADD SERVER Filter by Name, Path or more

Server Type	Server Name	Server IP Address	Lease Time (seconds)	Edge Cluster	Where Used	Tags
DHCP Server	DHCP	10.16.100.1/24	86400	TNT47-CLSTR		Tag Scott Max 30 allowed. Click (+) to save.

SAVE CANCEL

Add a network segment in Azure VMware Solution After setting up DHCP, add a network segment.

To add a network segment, in NSX-T Manager, select **Networking > Segments**, and then click **Add Segment**.

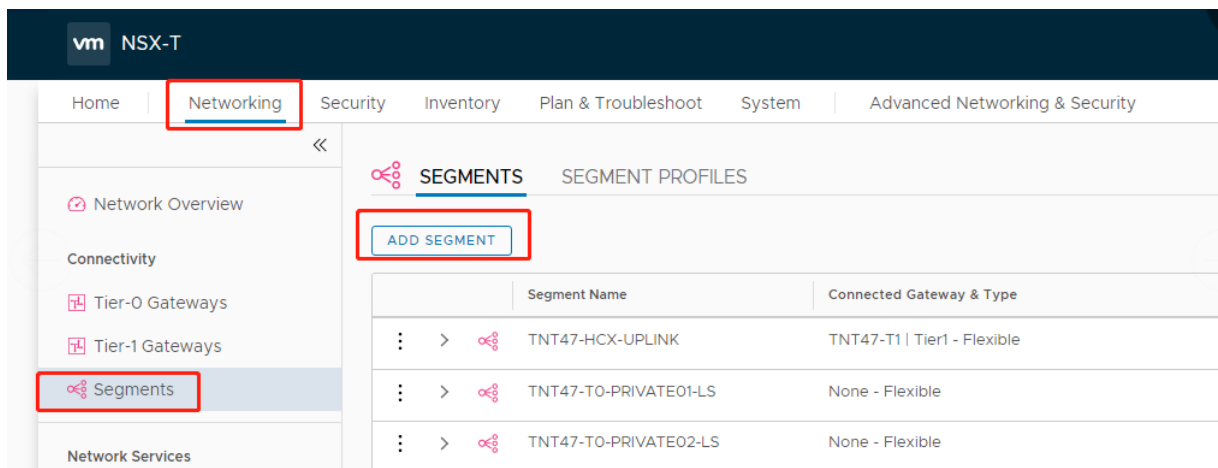

In the **Segments profile** screen:

1. Enter a **name** for the segment.
2. Select the **Tier-1 Gateway (TNTxx-T1)** as the **Connected Gateway** and leave the **Type** as **Flexible**.
3. Select the pre-configured overlay **Transport Zone(TNTxx-OVERLAY-TZ)**.
4. Click **Set Subnets**.

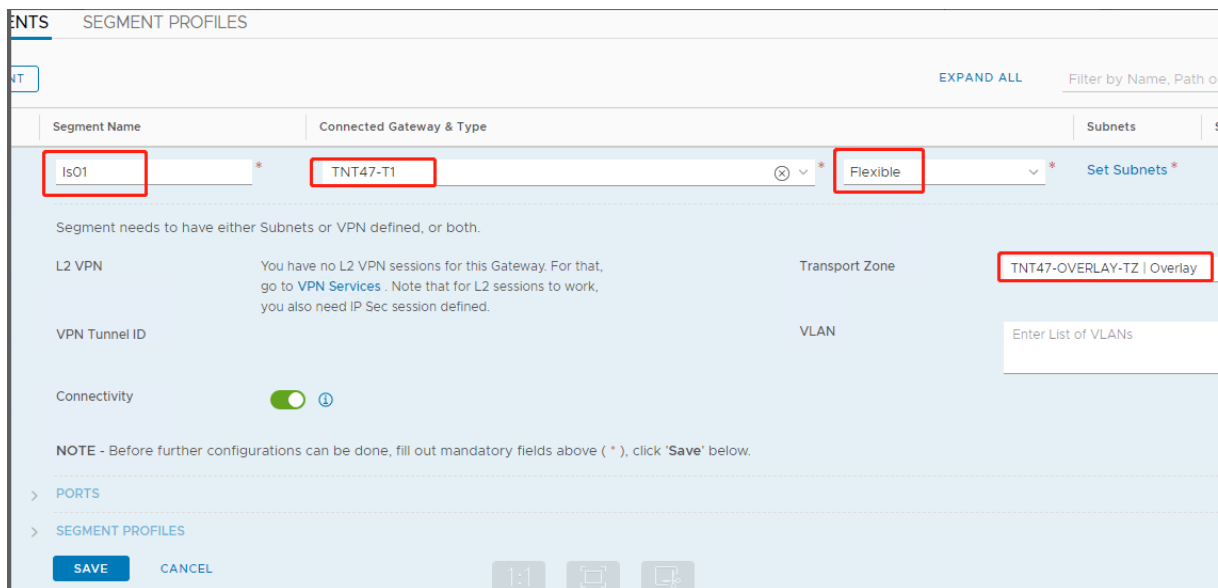

In the **Subnets** section:

1. Enter the gateway IP address.
2. Select **Add**.

Important:

This segment IP address must belong to the Azure gateway IP address, 10.15.0.0/22.

DHCP range should belong to segment IP address:

Segment name ↑↓	Connected gateway ↑↓	Gateway IP ↑↓	DHCP range ↑↓	Port/VIF ↑↓	State ↑↓
NetworkSEG-0	TNT47-T1	10.15.4.1/24	10.15.4.100-10.15.4.200	6	SUCCESS

Select **No** to decline the option to continue configuring the segment:

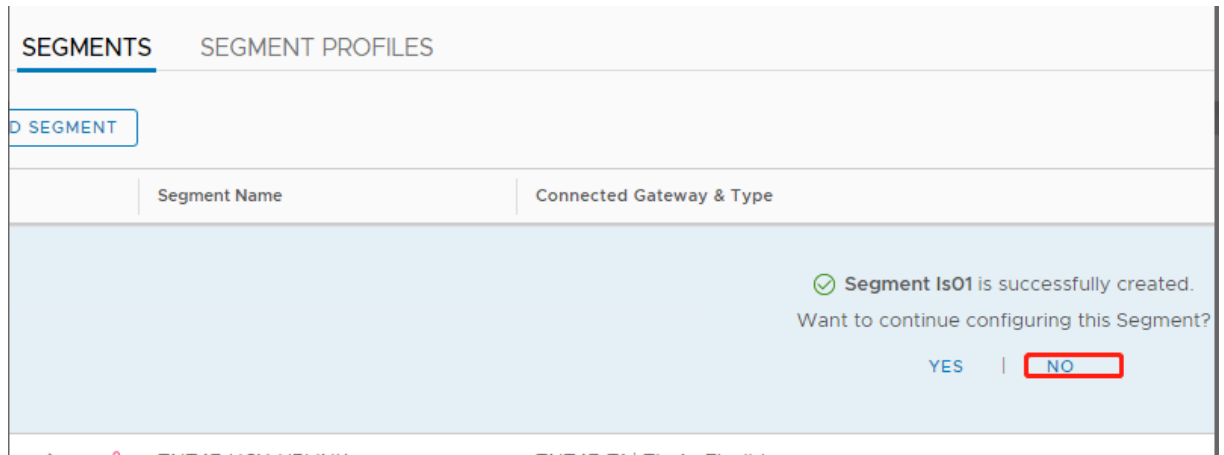

In vCenter, select **Networking > SDDC-Datacenter**:

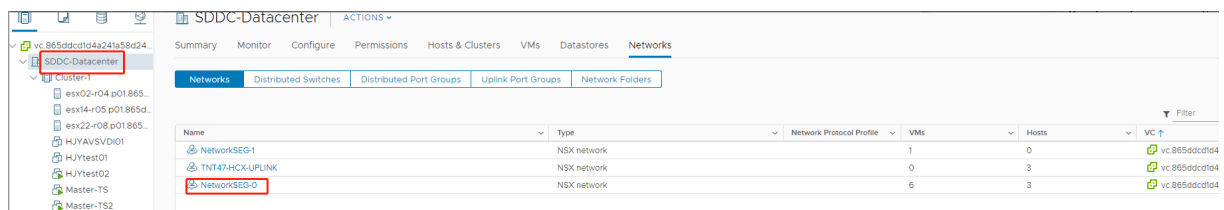

Verify the Azure AVS environment Setup a direct connection and connector in the Azure resource group:

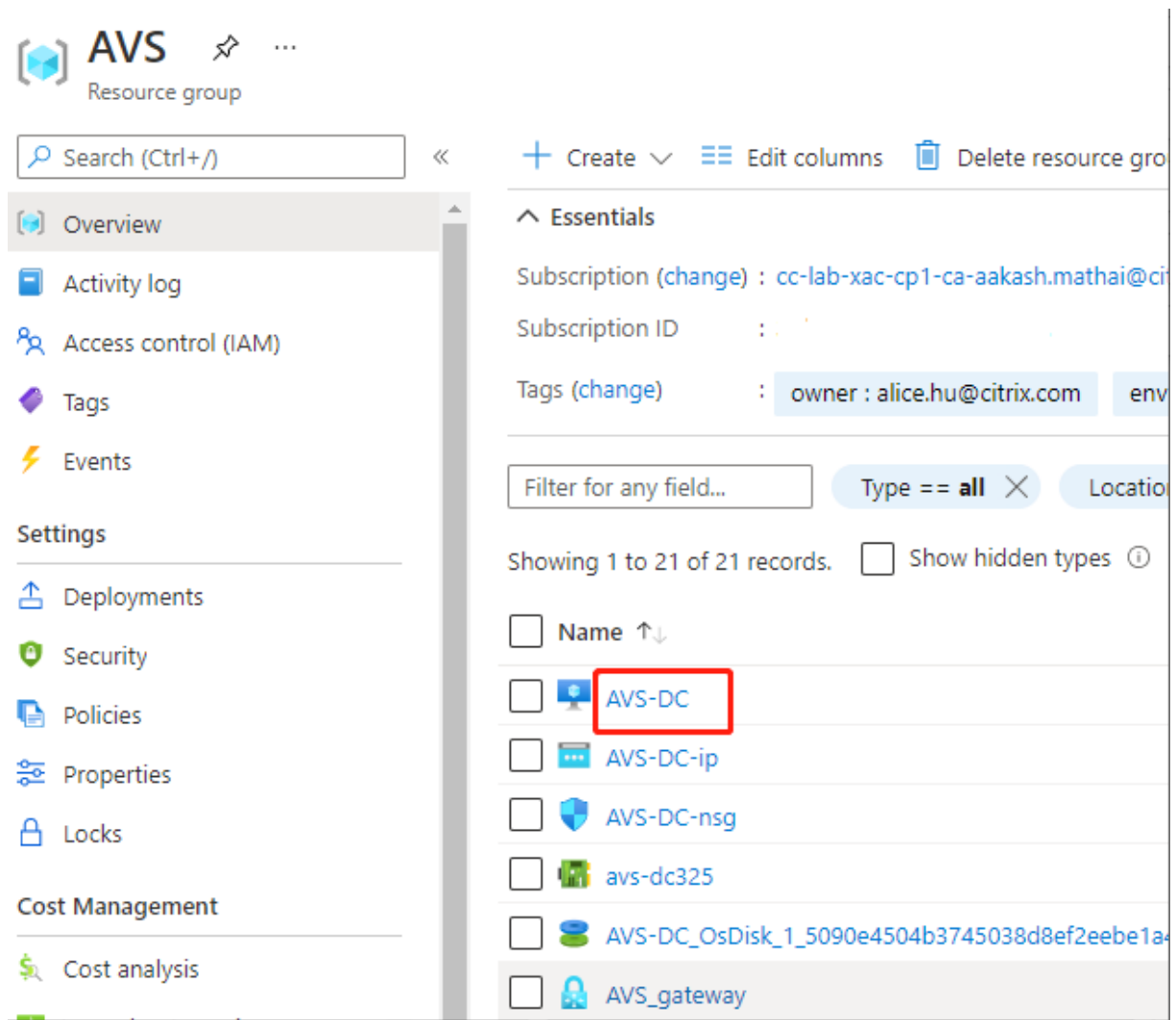

Verify the connection with vCenter credentials:

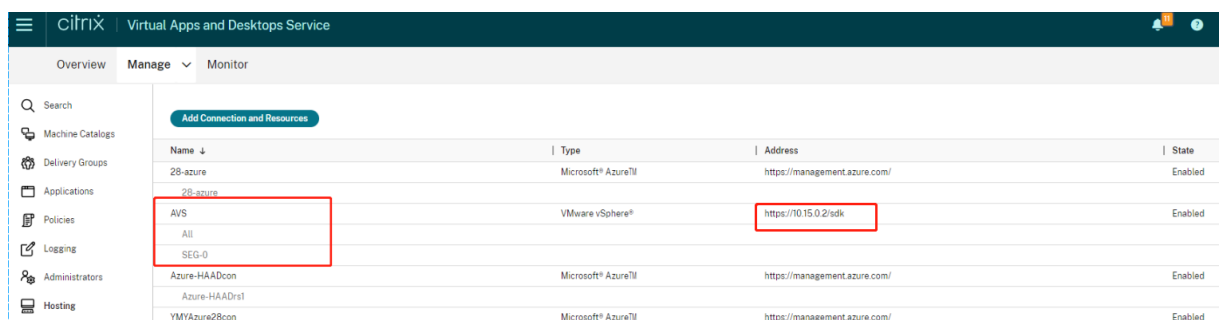

Google Cloud VMware Engine

Citrix Virtual Apps and Desktops lets you migrate VMware-based on-premises Citrix workloads to Google Cloud VMware Engine.

Configure Google Cloud VMware Engine

The following procedure describes how to acquire and set up cluster on Google Cloud VMware Engine.

Access the VMware Engine portal

1. In the **Google Cloud Console**, click the navigation menu.
2. In the **Compute** section, click **VMware Engine** to open VMware Engine in a new browser tab.

Requirements to create first private cloud You must have access to Google Cloud VMware Engine, available VMware Engine node quota, and an appropriate IAM role. Prepare the following requirements before you continue to create your private cloud:

1. Request API access and node quota. For more information, see [Requesting API access and quota](#).
2. Note the address ranges you want to use for VMware management appliances and the HCX deployment network. For more information, see [Networking requirements](#).
3. Get the VMware Engine Service Admin IAM role.

Create your first private cloud

1. Access the VMware Engine portal.
2. On the VMware Engine Home page, click **Create a private cloud**. The hosting location and hardware node types are listed.
3. Select the number of nodes for the private cloud. At least three nodes are required.
4. Enter a Classless Inter-Domain Routing (CIDR) range for the VMware management network.
5. Enter a CIDR range for the HCX deployment network.

Important:

The CIDR range must not overlap with any of your on-premises or cloud subnets. The CIDR range must be /27 or higher.

6. Select **Review and create**.
7. Review the settings. To change any settings, click **Back**.
8. Click **Create** to begin creating the private cloud.

As VMware Engine creates your new private cloud, it deploys several VMware components and sets up initial Autoscale policies for clusters in the private cloud. Private cloud creation can take 30 minutes to 2 hours. After the provisioning is complete, you receive an email.

Set up Google Cloud VMware Engine VPN Gateway To establish an initial connectivity to Google Cloud VMware Engine, you can use a VPN gateway. This is an OpenVPN-based client VPN using which you can connect to your VMware Software Defined Data Center (SDDC) vCenter and do any initial configuration required.

Before deploying VPN gateway, configure the **Edge Services** range for the region where your SDDC is deployed. To do this:

1. Log on to the **Google Cloud VMware Engine** portal, and go to **Network > Regional Settings**. Click **Add Region**.
2. Choose the region where your SDDC is deployed and enable **Internet Access** and **Public IP Service**.
3. Supply the Edge Services range noted during planning and click **Submit**. Enabling these services take 10–15 minutes.

Once complete, the Edge Services show as **Enabled** on the Regional Settings page. Enabling these settings allow Public IPs to be allocated to your SDDC, which is a requirement for deploying a VPN gateway.

To deploy a VPN gateway:

1. In the **Google Cloud VMware Engine** portal, go to **Network > VPN Gateways**. Click **Create New VPN Gateway**.
2. Supply the name for the VPN gateway and the client subnet reserved during planning. Click **Next**.
3. Select users to grant VPN access. Click **Next**.
4. Specify the networks that must be accessible over VPN. Click **Next**.
5. A summary screen is displayed. Verify the selections, and click **Submit** to create the VPN Gateway. The VPN Gateways page is displayed with the status of the new VPN gateway as **Creating**.
6. After the status changes to **Operational**, click the new VPN gateway.
7. Click **Download my VPN configuration** to download a ZIP file containing pre-configured OpenVPN profiles for the VPN gateway. Profiles for connecting through UDP/1194 and TCP/443 are available. Choose your preference and import it into OpenVPN, and then connect.
8. Go to **Resources** and select your SDDC.

Connect the VPN

1. Establish a point-to-site connection between your on-premises network and the private cloud through the VPN Gateway setup. See Set up Google Cloud VMware Engine VPN Gateway.
2. Upload the VPN configuration downloaded in Set up Google Cloud VMware Engine VPN Gateway.
3. Import to your VPN client, for example, OpenVPN Connect.

For more information, see [Connecting using VPN](#).

Create first subnet

Access NSX-T Manager from the VMware Engine portal The process of creating a subnet happens in NSX-T, which you access through VMware Engine. Do the following to access NSX-T Manager.

1. Log on to the **Google Cloud VMware Engine** portal.
2. From the main navigation, go to **Resources**.
3. Click the **Private cloud name** corresponding to the private cloud where you want to create the subnet.
4. On the details page of your private cloud, click the **vSphere Management Network** tab.
5. Click the **FQDN** corresponding to the NSX-T Manager.
6. When prompted, enter your sign-in credentials. If you have set up vIDM and connected it to an identity source, such as Active Directory, use your identity source credentials instead.

Reminder:

You can retrieve generated credentials from the private cloud details page.

Set up DHCP service for the subnet Before you can create a subnet, set up a DHCP service:

In NSX-T Manager:

1. Go to **Networking > DHCP**. The networking dashboard shows that the DHCP service creates one Tier-0 and one Tier-1 gateway.
2. To begin provisioning a DHCP server, click **Add Server**.
3. Select **DHCP** for the **Server Type**, provide the server name and IP address.
4. Click **Save** to create the DHCP service.

Do the following to attach this DHCP service to the relevant Tier-1 gateway. A default Tier-1 gateway is already provisioned by the DHCP service:

1. Select **Tier 1 Gateways**, select the vertical ellipsis on the Tier-1 gateway, and then select **Edit**.
2. In the **IP Address Management** field, select **No IP Allocation Set**.
3. Select **DHCP Local Server** for the **Type**.
4. Select the DHCP server that you created for the **DHCP Server**.
5. Click **Save**.
6. Click **Close Editing**.

You can now create a network segment in NSX-T. For more information about DHCP in NSX-T, see the [VMware documentation for DHCP](#).

Create a network segment in NSX-T For workload VMs, you create subnets as NSX-T network segments for your private cloud:

1. In NSX-T Manager, go to **Networking > Segments**.
2. Click **Add Segment**.
3. Enter a name for the segment.
4. Select the **Tier-1** as the **Connected Gateway** and leave the Type as **Flexible**.
5. Click **Set Subnets**.
6. Click **Add Subnets**.
7. Enter the subnet range in the **Gateway IP/Prefix Length**. Specify the subnet range with **.1** as the last octet. For example, **10.12.2.1/24**.
8. Specify the DHCP Ranges and click **ADD**.
9. In **Transport Zone**, select **TZ-OVERLAY** from the drop-down list.
10. Click **Save**. You can now select this network segment in vCenter when creating a VM.

In a given region, you can set up at most 100 unique routes from VMware Engine to your VPC network using private services access. This includes, for example, private cloud management IP address ranges, NSX-T workload network segments, and HCX network IP address ranges. This limit includes all private clouds in the region.

Note:

There is a Google Cloud configuration issue because of which you need to configure DHCP range setting several times. Therefore, make sure to configure the DHCP range setting after Google Cloud configuration. Click **EDIT DHCP CONFIG** to configure the DHCP ranges.

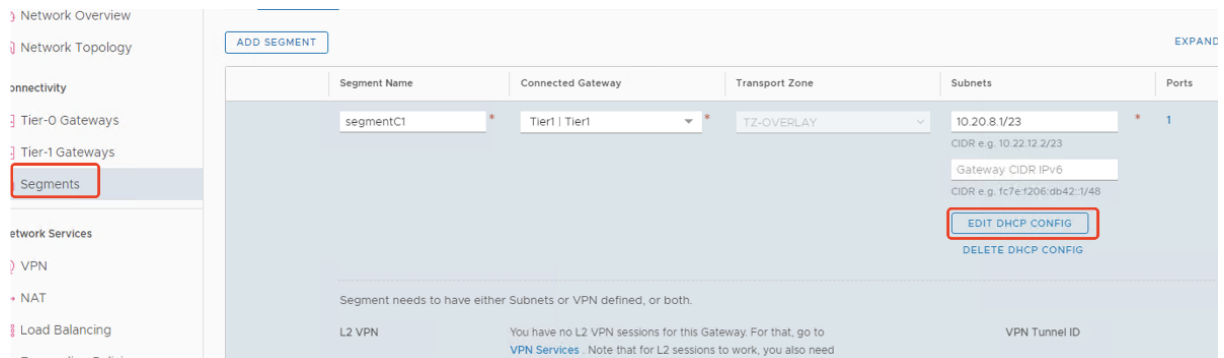

Set DHCP Config

Segment segmentC1

IPv4 Gateway 10.20.8.1/23 #DHCP Ranges ⓘ

IPv6 Gateway Not Set #DHCP Ranges ⓘ

DHCP Type * Gateway DHCP Server ⓘ

DHCP Profile dhcp

ⓘ IPv6 server settings are not supported for Gateway DHCP

IPv4 Server IPv6 Server

Settings | Options

DHCP Config Enabled ⓘ

DHCP Server Address 10.20.6.1/23

DHCP Ranges

99 Maximum | Format 172.16.14.10-172.16.14.100 or 172.16.14.0/24 | Please verify that IP addresses in this range are not in range to avoid duplicate IP address allocation

10.20.8.10-10.20.8.200 X

Belong to subnet CIDR

Enter DHCP Ranges

Lease Time (seconds) 86400

DHCP Servers

Create the Google Cloud VMware connection in Citrix Studio

1. Create a machine in vCenter.
2. Launch the Citrix Studio.
3. Select the hosting node, and click **Add Connection and Resources**.
4. On the **Connection** screen, select **Create a new Connection**, and the following details:

Add Connection and Resources

- 1 Connection
- 2 Storage Manageme...
- 3 Storage Selection
- 4 Network
- 5 Scopes
- 6 Summary

Create a new connection

Connection type: VMware vSphere®

Connection address: https://10.129.0.6/sdk

[Learn about user permissions](#)

User name: CloudOwner@gve.local

Password:

Zone name: VMware-GCP

Connection name: VMware-GCP1

Create virtual machines using:

Citrix provisioning tools (Machine Creation Services or Citrix Provisioning)

Next Cancel

- a) Select **Connection type** as **VMware vSphere**.
 - b) In the **Connection address**, enter the vCenter private IP address.
 - c) Enter the vCenter credentials.
 - d) Enter a connection name.
 - e) Choose the tool to create virtual machines.
5. On the **Network** screen, select the subnet created in NSX-T server.
 6. Complete the wizard.

VMware cloud on Amazon Web Services (AWS)

VMware cloud on Amazon Web Services (AWS) enables you to migrate VMware based on-premises Citrix workloads to AWS Cloud.

This article describes the procedure to set up a VMware cloud on AWS.

Access the VMware cloud environment

1. Log in to VMware cloud services using the URL <https://console.cloud.vmware.com/>.

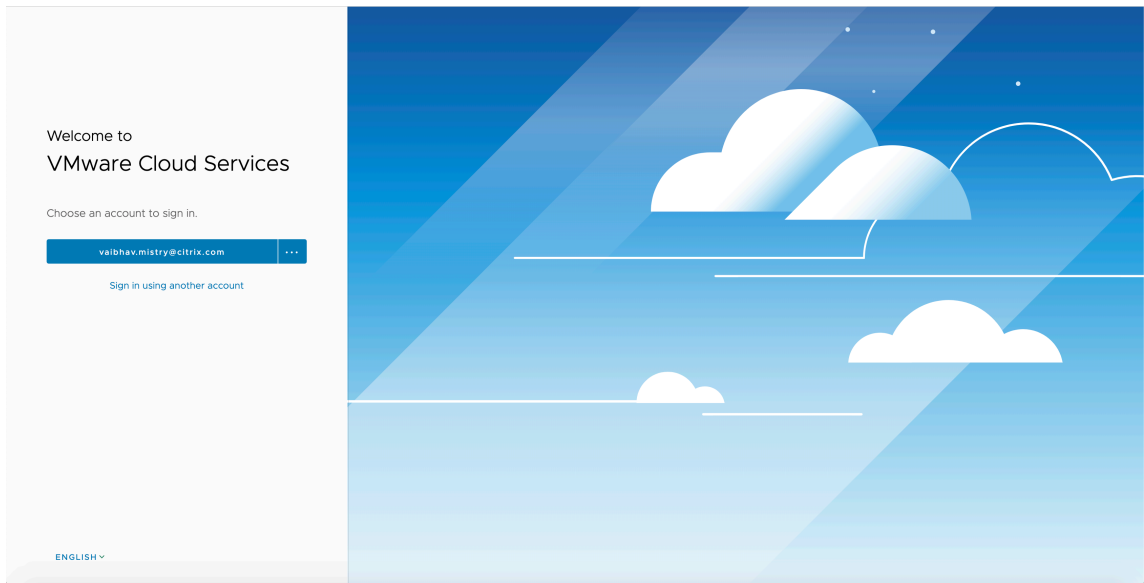

2. Click **VMware Cloud on AWS**. The page Software-Defined Data Centers (SDDC) appears.

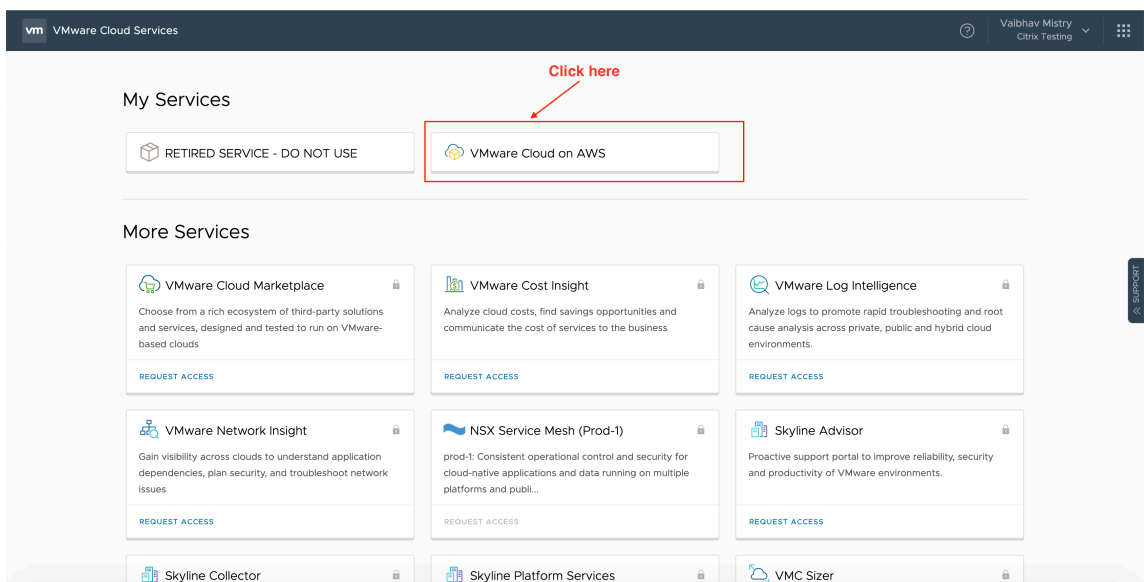

3. Click **OPEN VCENTER**, and then click **SHOW CREDENTIALS**. Note the credentials for later use.

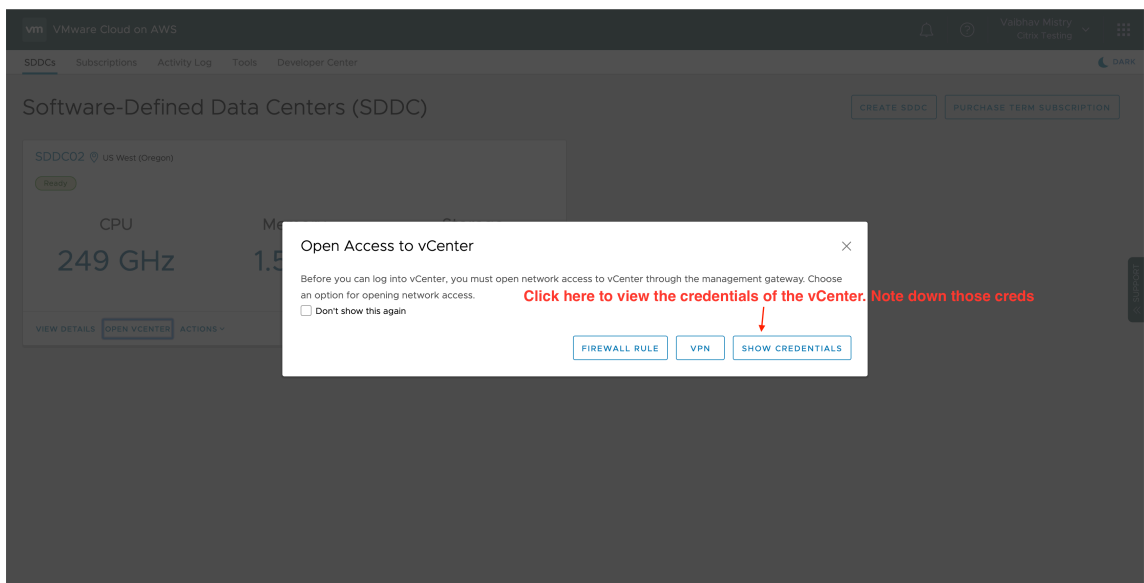
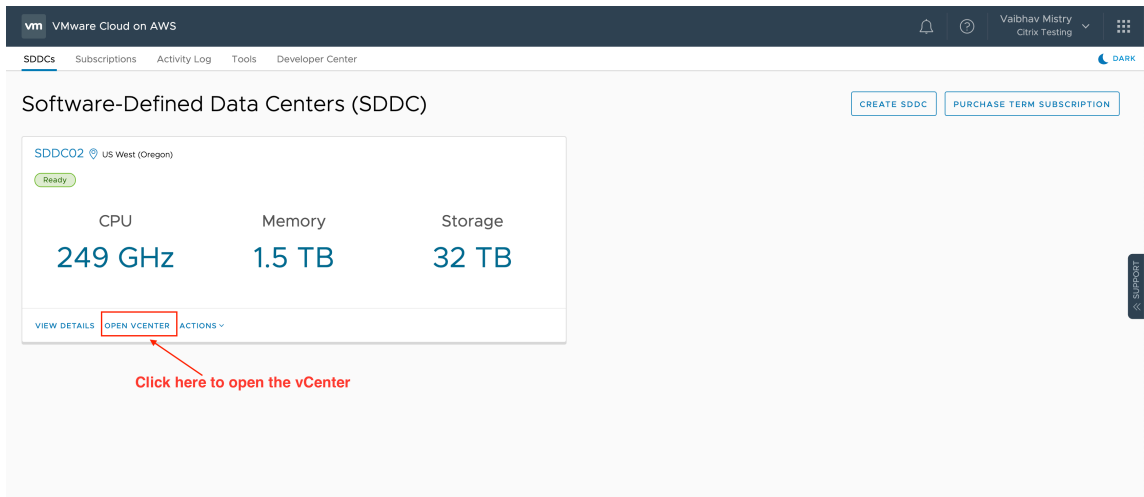

4. Open a Web browser and enter the URL for the vSphere Web Client.
5. Enter the credentials as noted and click **Login**. The vSphere client webpage is similar to the on-premises environment.

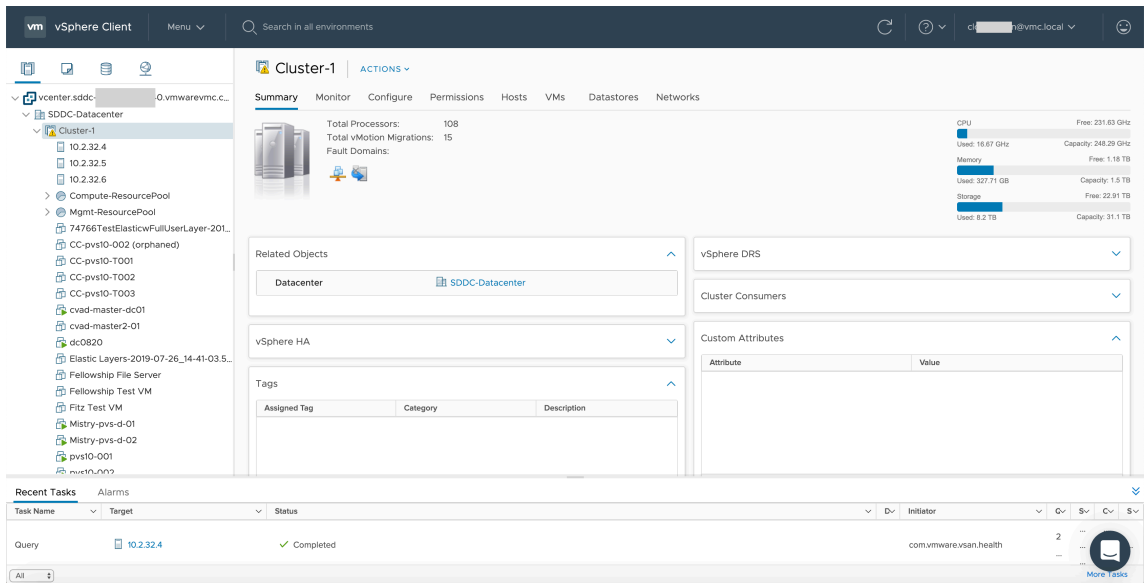

About VMware cloud environment

There are four views on the vSphere client webpage.

- Host and Cluster view: You cannot create a new Cluster, but the cloud admin can create multiple resource pools.

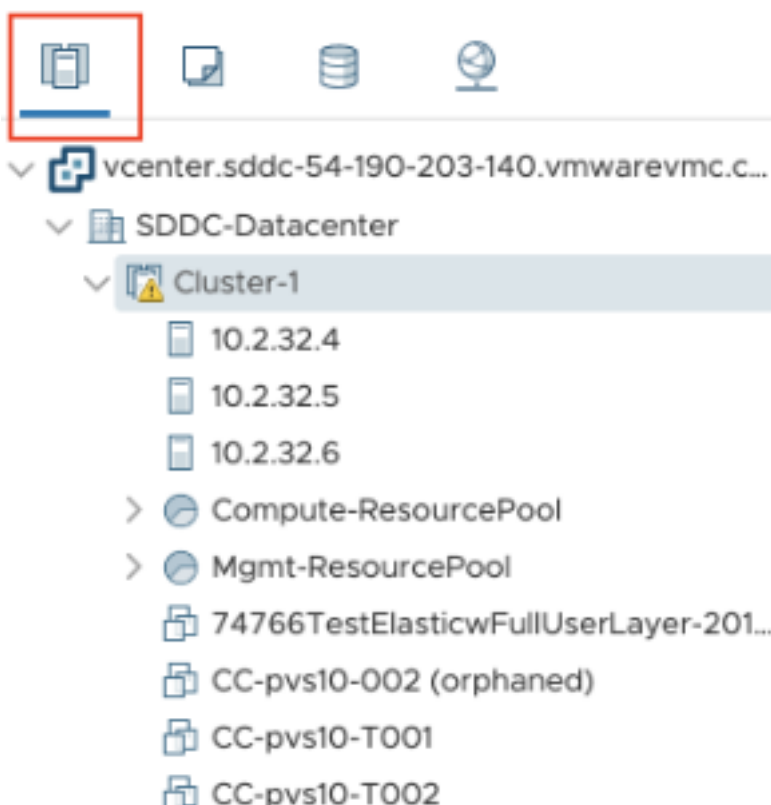

- VM and Template view: Cloud admin can create many folders.

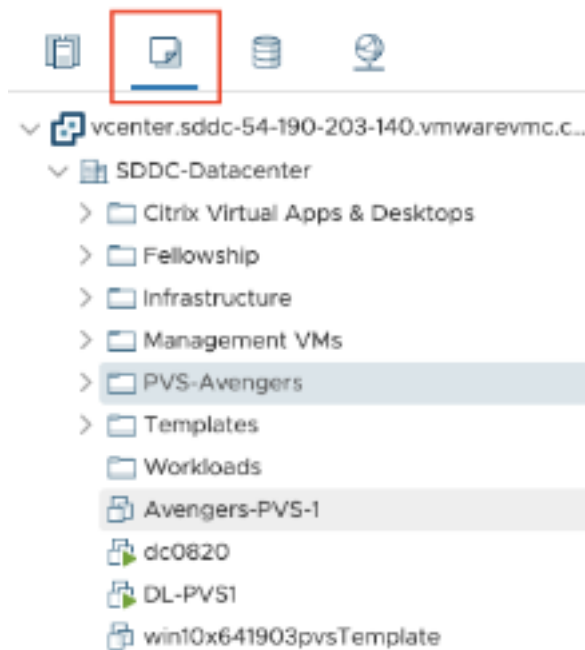

- Storage View: Select **WorkloadDatastore** storage when you add hosting unit in the Citrix Studio because you have access to only Workload Datastore.

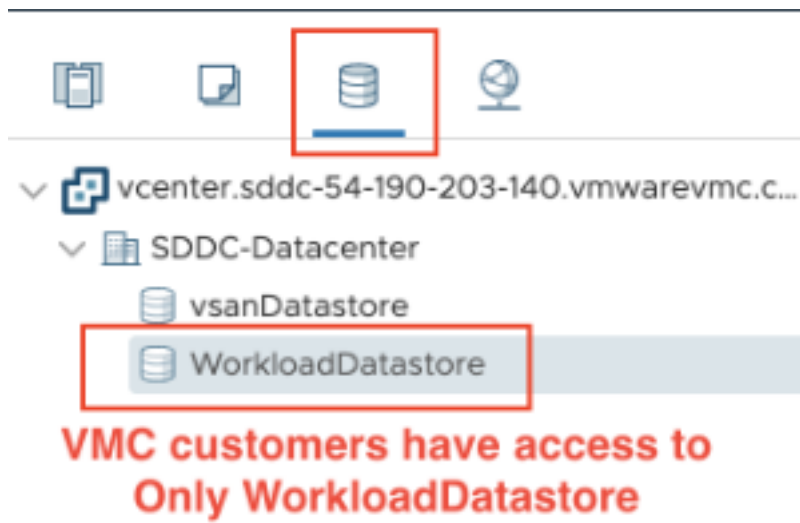

- Network View: The icons are different for VMware cloud networks and opaque networks.

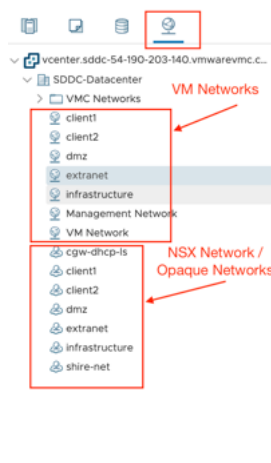

After you set up the cluster, refer to [VMware virtualization environments](#) for adding connections and resources.

Where to go next

- [Install core components](#)
- [Install VDAs](#)
- [Create a site](#)

- For creating and managing a connection, see [Connection to VMware cloud and partner solutions](#)

More information

- [Create and manage connections and resources](#)
- [Create machine catalogs](#)

Install core components

March 13, 2024

Important:

Citrix collects basic licensing data as necessary for its legitimate interests, including license compliance. For more information, see [Citrix Licensing Data](#).

The core components are the Citrix Delivery Controller, Citrix Studio, Web Studio, Citrix Director, and Citrix License Server.

Note:

Citrix Studio is a Windows-based management console that lets you configure and manage your on-premises Citrix Virtual Apps and Desktops deployment. Web Studio is the next generation of Citrix Studio—a web-based management console offering full feature parity with Citrix Studio. For more information about Web Studio, see [Install Web Studio](#).

(In versions before 2003, core components included Citrix StoreFront. You can still install StoreFront by clicking the **Citrix StoreFront** tile or running the command available on the installation media.)

Before you start an installation, review this article and [Prepare to install](#).

This article describes the installation wizard sequence when installing core components. Command-line equivalents are provided. For more information, see [Install using the command line](#).

Step 1. Download the product software and launch the wizard

Use your Citrix account credentials to access the Citrix Virtual Apps and Desktops download page. Download the product ISO file.

Unzip the file. Optionally, burn a DVD of the ISO file.

Log on to the machine where you are installing the core components, using a local administrator account.

Insert the DVD in the drive or mount the ISO file. If the installer does not launch automatically, double-click the **AutoSelect** application or the mounted drive.

Step 2. Choose which product to install

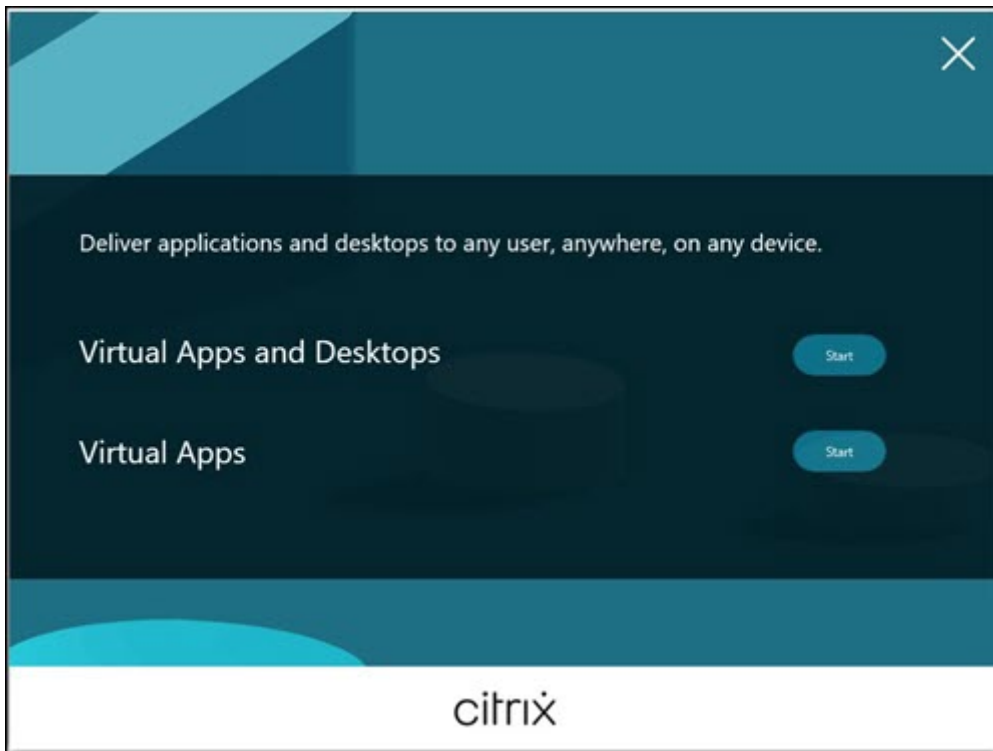

Click **Start** next to the product to install: Virtual Apps or Virtual Apps and Desktops.

(If the machine already has Citrix Virtual Apps and Desktops components installed on it, this page does not appear.)

Command-line option: `/xenapp` to install Citrix Virtual Apps. Citrix Virtual Apps and Desktops is installed if option is omitted.

Step 3. Choose what to install

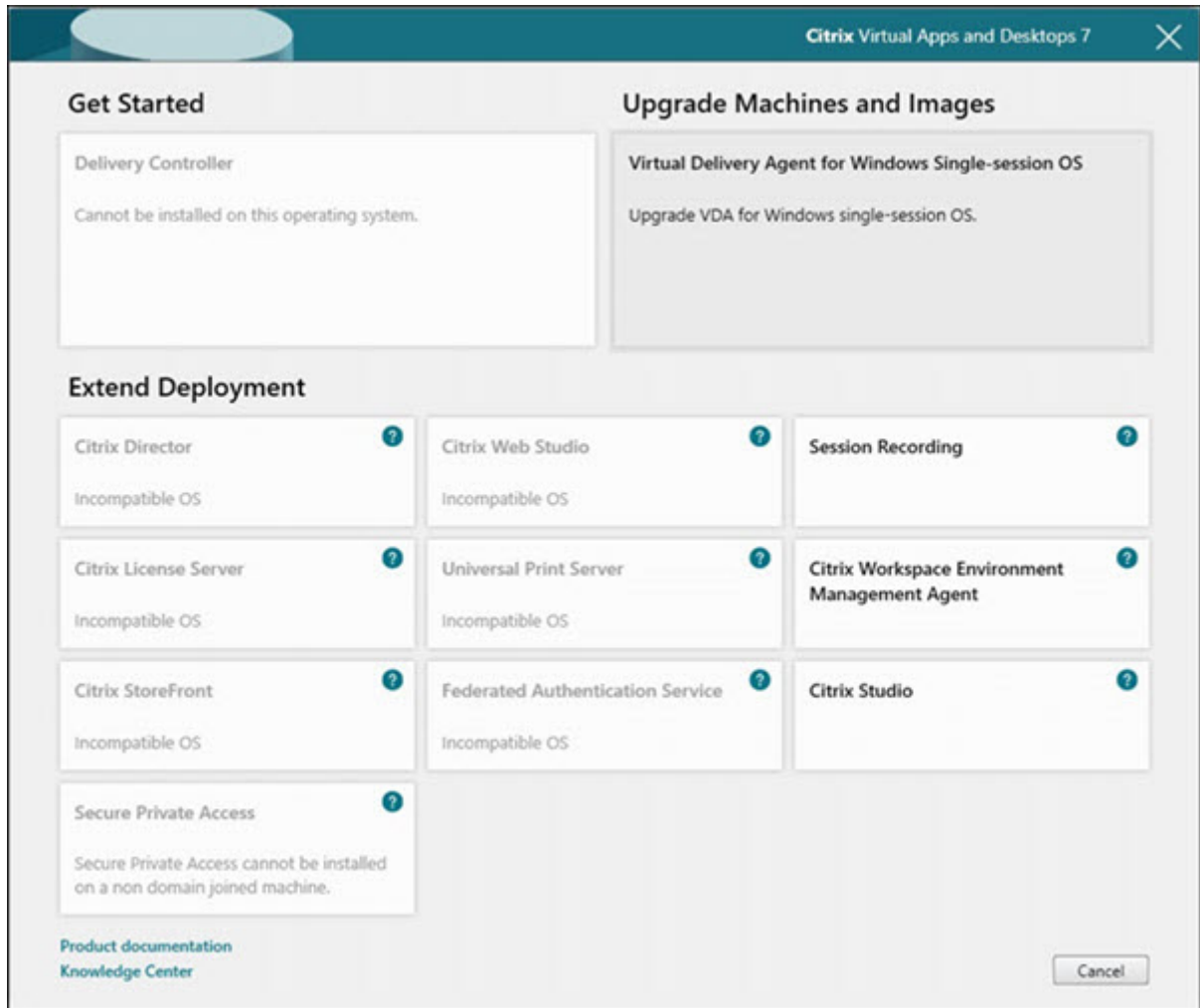

If you're just getting started, select **Delivery Controller**. (On a later page, you select the specific components to install on this machine.)

If you've already installed a Controller (on this machine or another) and want to install another component, select the component from the **Extend Deployment** section.

Command-line option: `/components`

Step 4. Read and accept the license agreement

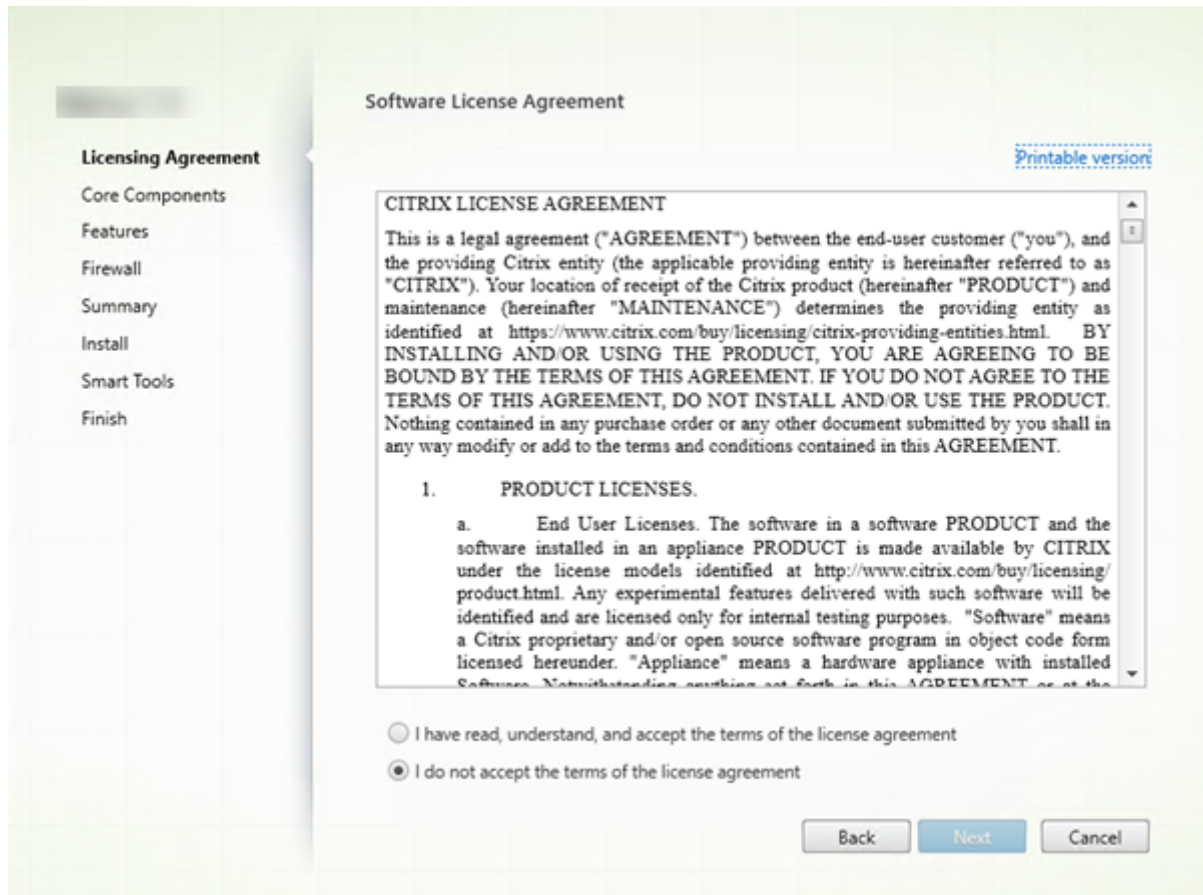

On the **Licensing Agreement** page, after you read the license agreement, indicate that you have read and accepted it. Then click **Next**.

Step 5. Select the components to install and the installation location

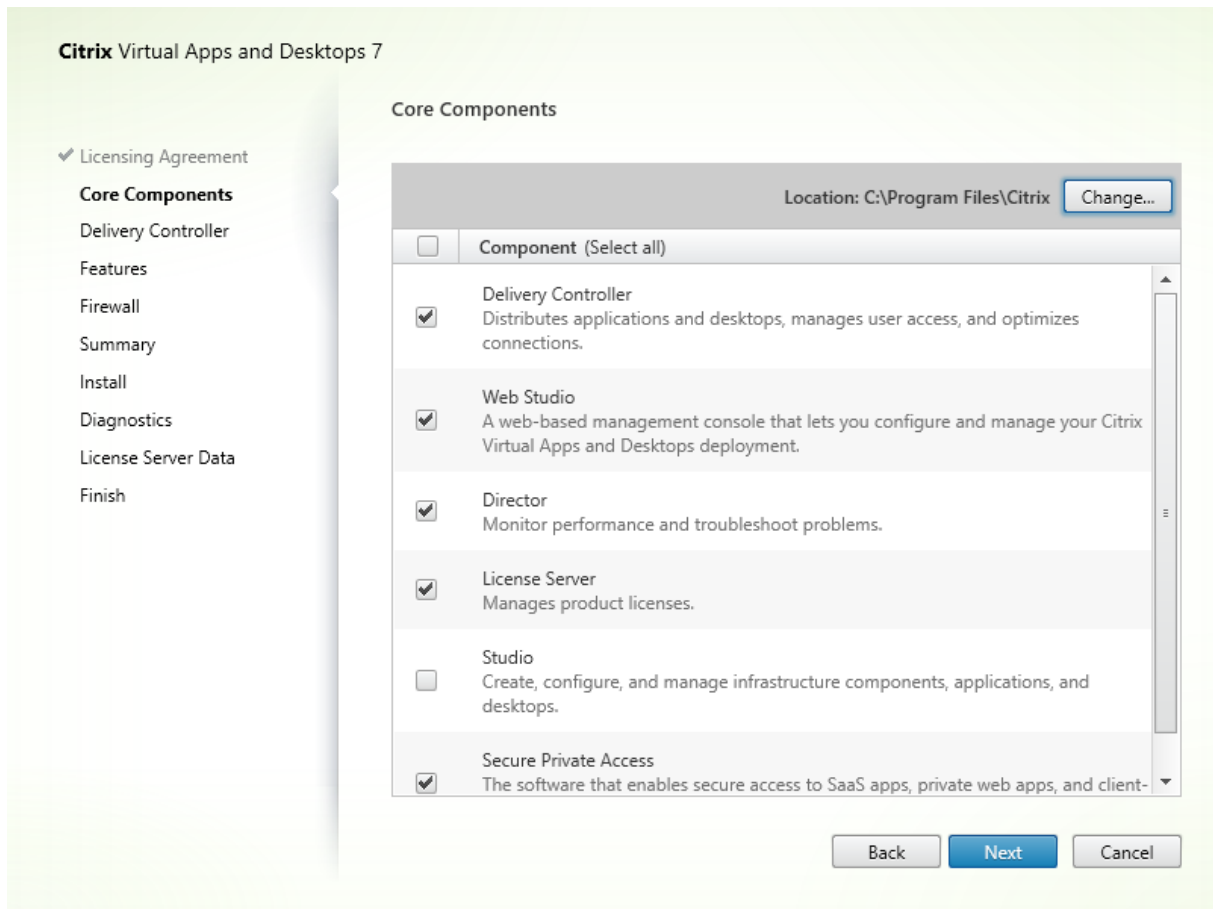

On the **Core components** page:

- **Location:** By default, components are installed in `C:\Program Files\Citrix`. The default is fine for most deployments. If you specify a different location, it must have execute permissions for the network service.
- **Components:** By default, the check boxes for all core components are selected. Installing all of the core components on one server is fine for proof of concept, test, or small production deployments. For larger production environments, Citrix recommends installing Director, StoreFront, Secure Private Access and the License Server on separate servers.

Note:

If you're installing components on more than one server, install the Citrix License Server and licenses first, before installing other components on other servers. For guidance, see the Automatic installation section of the [Licensing Guide for Citrix Virtual Apps and Desktops](#).

An icon alerts you when you choose not to install a required core component on this machine.

That alert reminds you to install that component, although not necessarily on this machine.

Click **Next**.

Command-line options: `/installdir`, `/components`, `/exclude`

Hardware check

When you install or upgrade a Delivery Controller, the hardware is checked. The installer alerts you if the machine has less than the recommended amount of RAM (5 GB), which can affect site stability. For more information, see [Hardware requirements](#).

Graphical interface: A dialog box appears.

- Recommended: Click **Cancel** to stop the installation. Add more RAM to the machine and then start the installation again.
- Alternatively, click **Next** to continue with the installation. The site might have stability issues.

Command-line interface: The install/upgrade ends. The install logs contain a message that describes what was found and the available options.

- Recommended: Add more RAM to the machine and then run the command again.
- Alternatively, run the command again with the `/ignore_hw_check_failure` option to override the warning. Your site might have stability issues.

When upgrading, you're also notified if the OS or SQL Server version is no longer supported. See [Upgrade a deployment](#).

Step 6. Enable or disable features

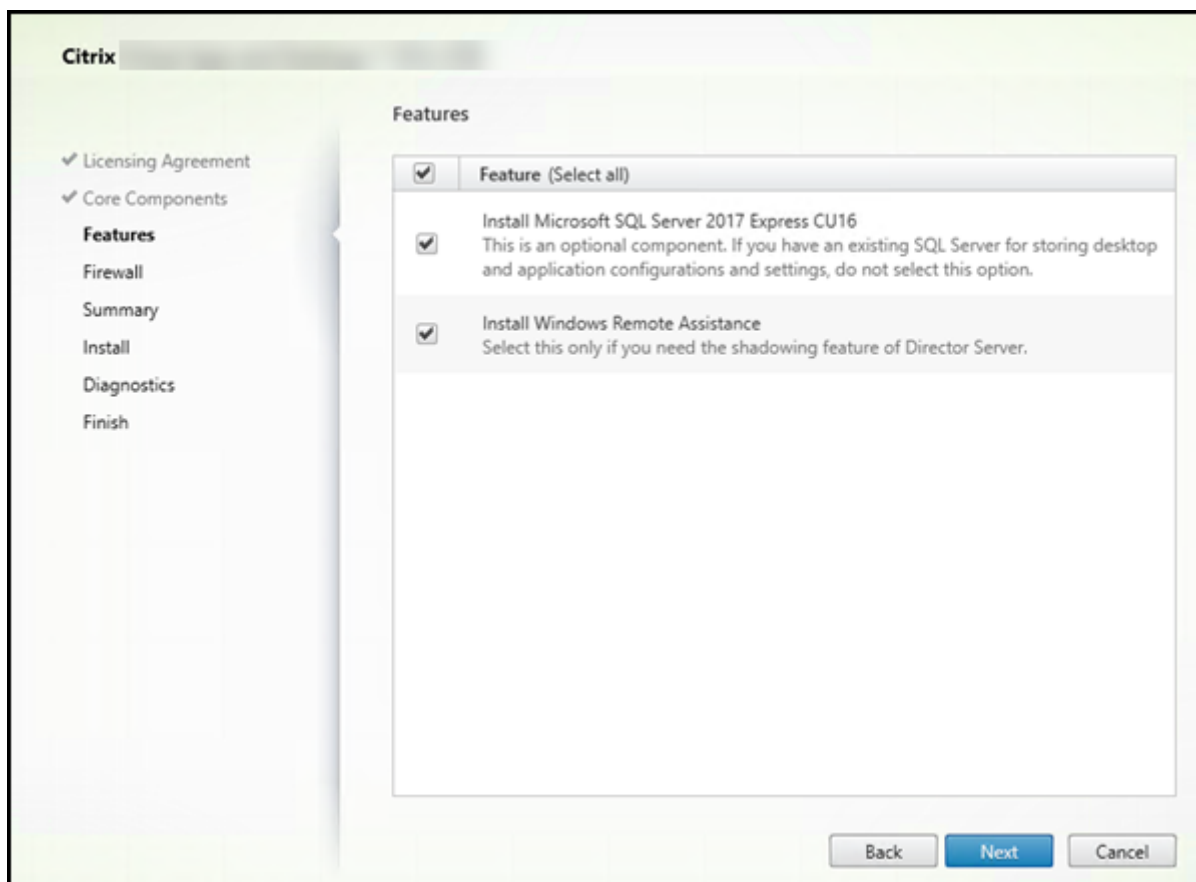

On the **Features** page:

- Choose whether to install Microsoft SQL Server Express for use as the site database. By default, this selection is enabled. If you're not familiar with the Citrix Virtual Apps and Desktops databases, review [Databases](#).
- When you install Director, Windows Remote Assistance is installed automatically. You choose whether to enable shadowing in Windows Remote Assistance for use with Director user shadowing. Enabling shadowing opens TCP port 3389. By default, this feature is enabled. The default setting is fine for most deployments. This feature appears only when you are installing Director.

Click **Next**.

Command-line options: `/nosql` (to prevent installation), `/no_remote_assistance` (to prevent enabling)

Step 7. Open Windows firewall ports

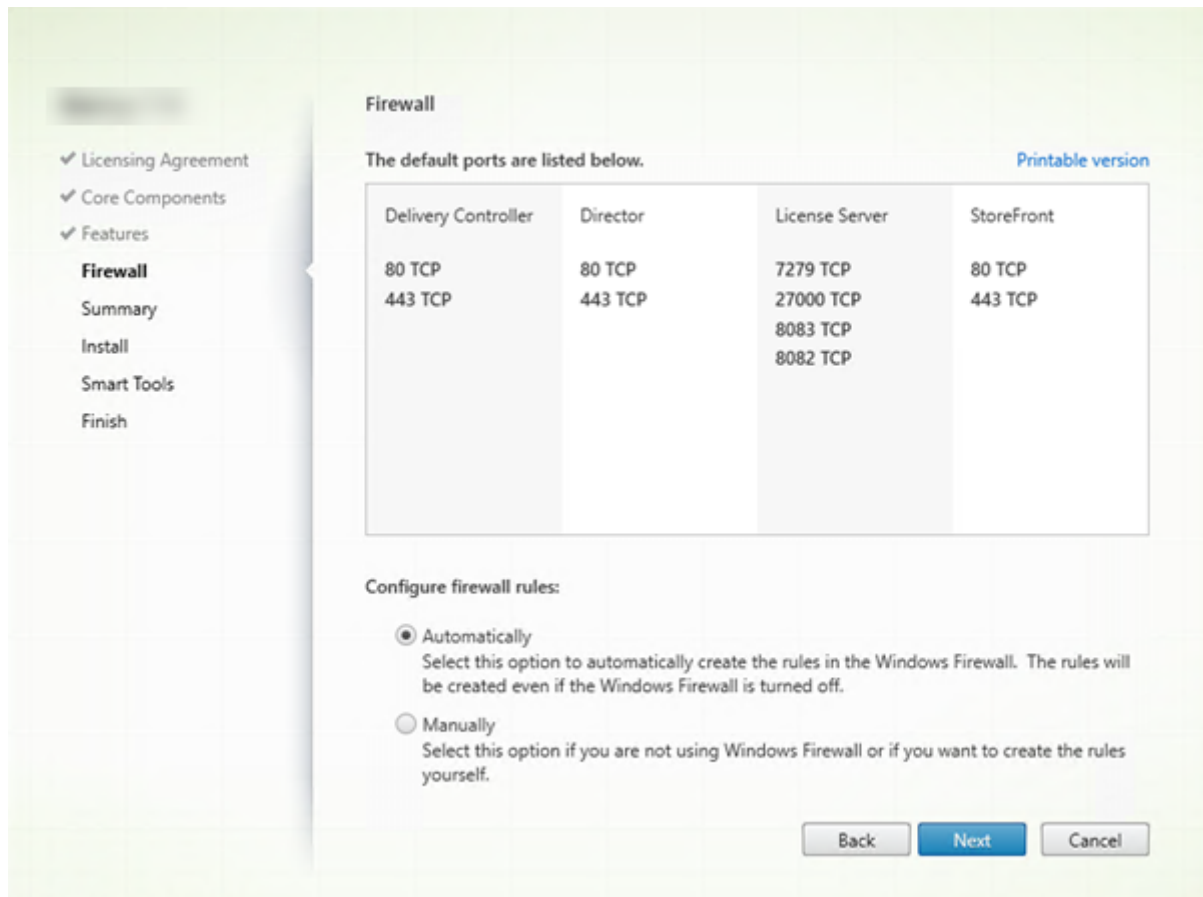

By default, the ports on the **Firewall** page are opened automatically if the Windows Firewall Service is running, even if the firewall is not enabled. The default setting is fine for most deployments. For port information, see [Network ports](#).

Click **Next**.

(The graphic shows the port lists when you install all the core components on this machine. That type of installation is usually for test deployments only.)

Command-line option: `/configure_firewall`

Step 8. Review prerequisites and confirm installation

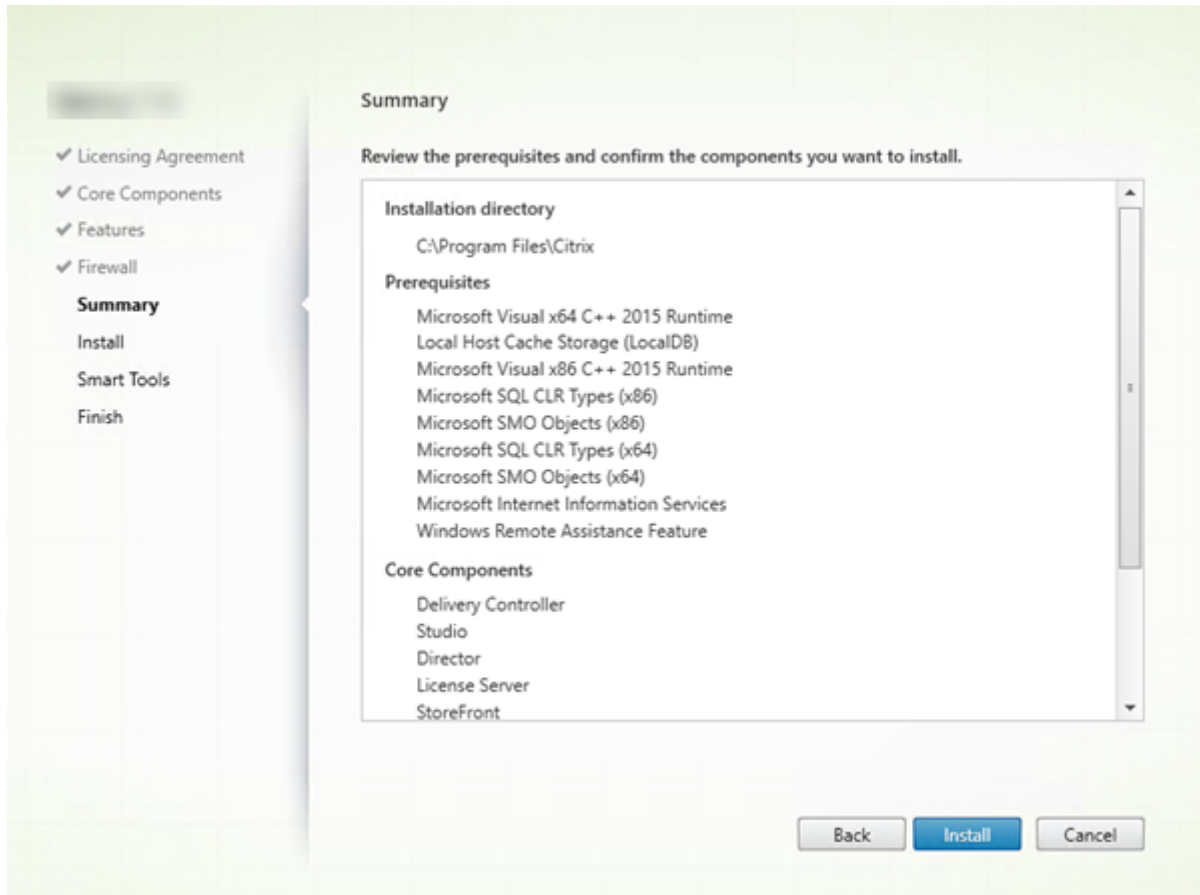

The **Summary** page lists what will be installed. Use the **Back** button to return to earlier wizard pages and change selections, if needed.

When you're ready, click **Install**.

The display shows the progress of the installation:

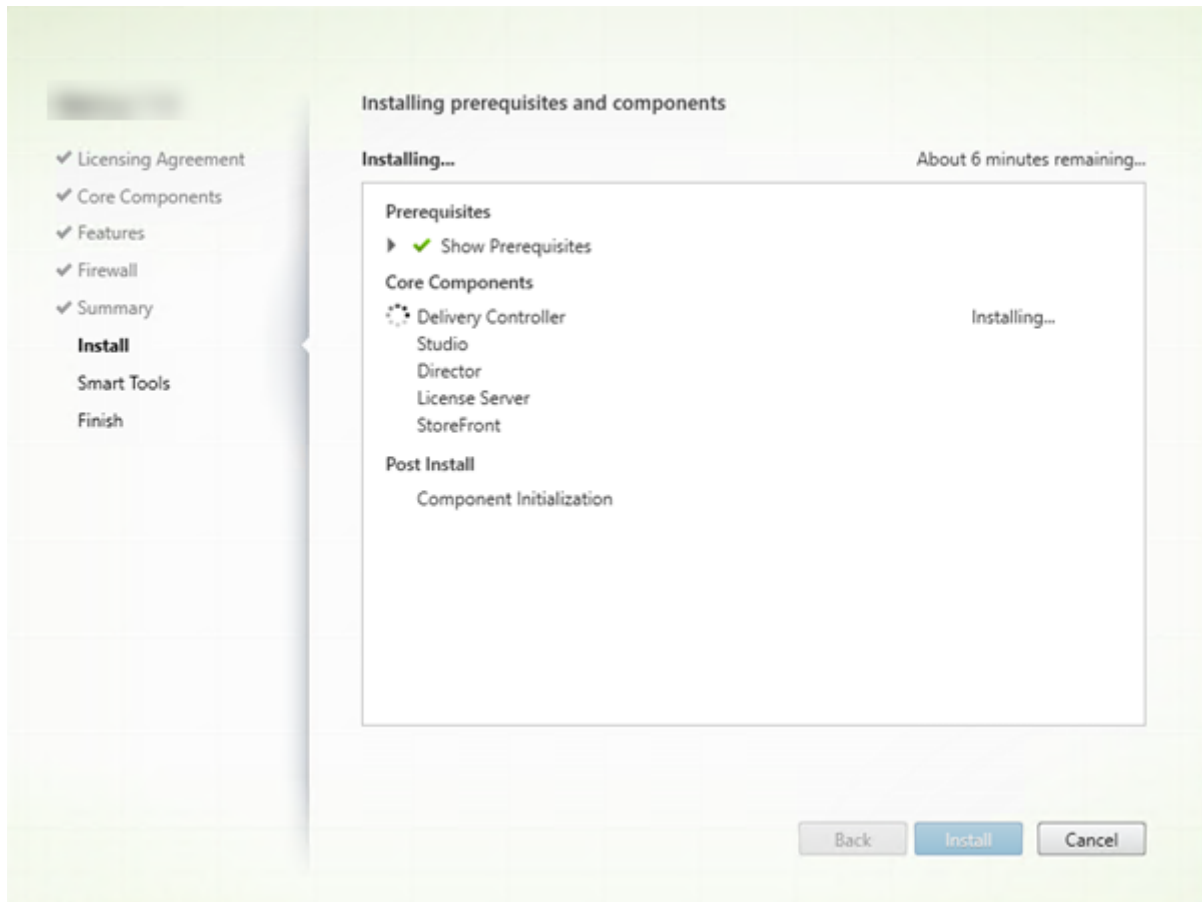

Step 9. Sharing diagnostics information with Cloud Software Group

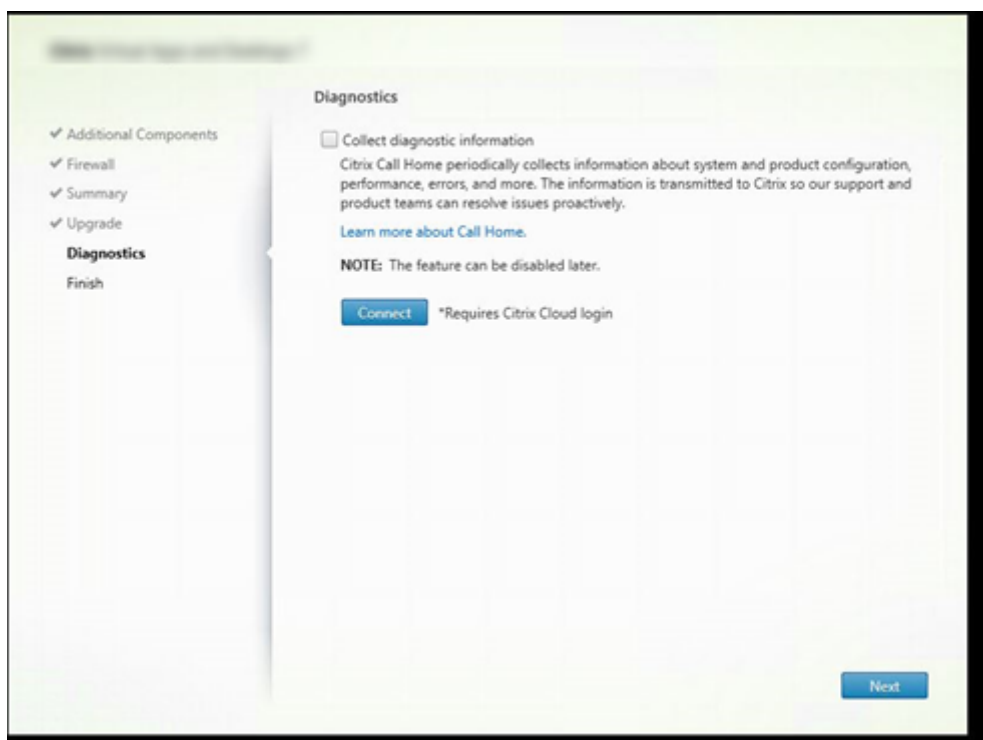

On the **Diagnostics** page, choose whether to participate in Citrix Call Home.

This page appears when installing a Delivery Controller using the graphical interface. When you install StoreFront (but not a Controller), the wizard displays this page. When you install other core components (but not a Controller or StoreFront), the wizard does not display this page.

During an upgrade, this page does not appear if Call Home is already enabled or if the installer encounters an error related to the Citrix Telemetry Service.

If you choose to participate (the default), click **Connect**. When prompted, enter your Citrix account credentials. You can change your enrollment choice later, after installation.

After your credentials are validated (or if you choose not to participate), click **Next**.

If you click **Connect** on the **Diagnostics** page without first selecting **Collect diagnostic information**, after you close the **Connect to Citrix Insight Services** dialog the **Next** button is disabled. You cannot move to the next page. To reenab the **Next** button, select and immediately deselect **Collect diagnostic information**.

For more information, see [Call Home](#).

Step 10. Sharing License Server data with Cloud Software Group

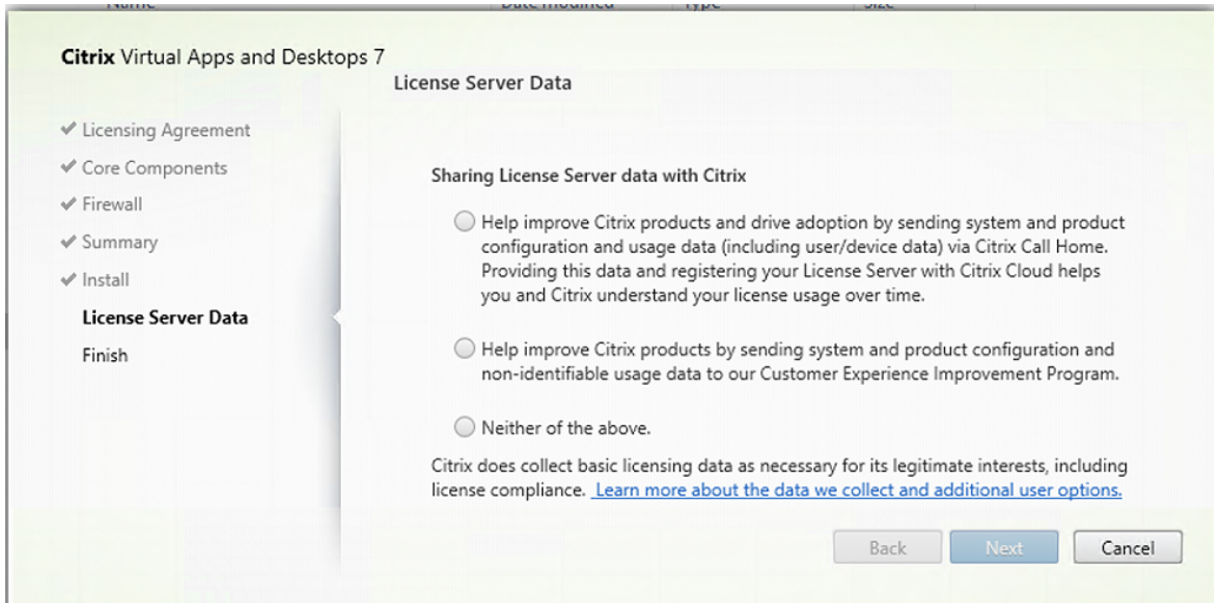

On the **License Server Data** page, we request that you share either Call Home data or Customer Experience Improvement Program (CEIP) data to assist us. In addition, Cloud Software Group also requires the collection of basic licensing data, including license compliance, as necessary for its legitimate interests.

The **License Server Data** page appears when you have installed License Server:

- As a standalone.
- As a core component, during installation of a Delivery Controller.

During an upgrade, this page does not appear if the configuration is already set in the `/CITRIX.opt` file.

License Server monitors several types of user data, such as licensing data, Call Home data and CEIP data. To enable Call Home data and CEIP data collection, you must choose to participate (opt in).

For more information about how to enable Call Home and CEIP data collection when installing by using the command line, see [Command line options for installing core components](#).

For more information about Cloud Software Group licensing data collection, see [Citrix Licensing data collection programs](#).

Step 11. Finish this installation

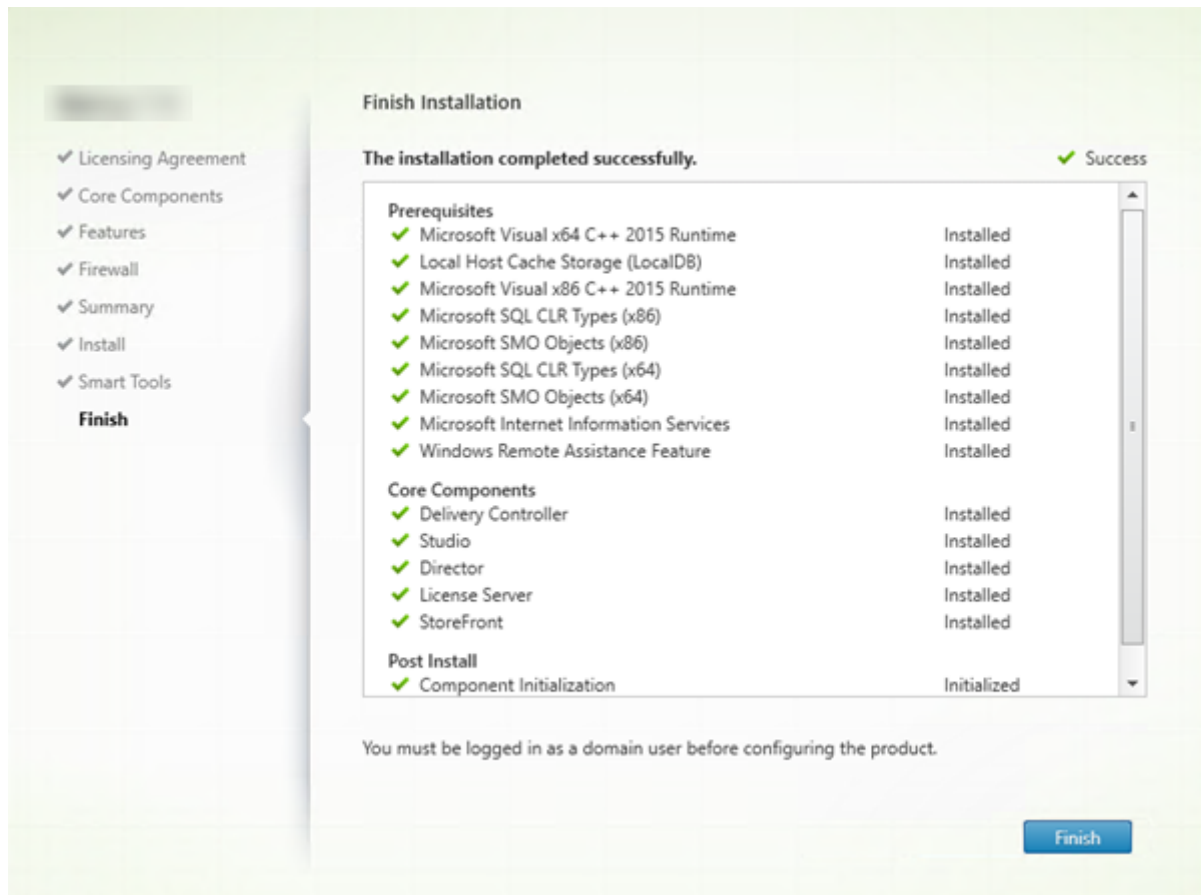

The **Finish** page contains green check marks for all prerequisites and components that installed and initialized successfully.

Click **Finish**.

Step 12. Install remaining core components on other machines

If you installed all the core components on one machine, continue with Next steps. Otherwise, run the installer on other machines to install other components. You can also install more Controllers on other servers.

Next steps

After you install all the required components, use Studio to [create a site](#).

After creating the site, [install VDAs](#).

At any time, you can use the full-product installer to extend your deployment with the following components:

- **Universal Print Server server component:** Launch the installer on your print server.
 1. Select **Universal Print Server** in the **Extend Deployment** section.
 2. Accept the license agreement.
 3. On the **Firewall** page, by default, TCP ports 7229 and 8080 are opened in the firewall if the Windows Firewall Service is running, even if the firewall is not enabled. You can disable that default action if you want to open the ports manually.

To install this component from the command line, see [Command-line options for installing a Universal Print Server](#).

- [Federated Authentication Service](#).
- [Session Recording](#).
- [Workspace Environment Management](#).

Install using the command line

March 19, 2024

Important:

- If you're upgrading, and your current version uses or has the Personal vDisk or AppDisks software installed, see [Removing PVD, AppDisks, and unsupported hosts](#).
- Citrix collects basic licensing data as necessary for its legitimate interests, including licensing compliance. For more information, see [Citrix Licensing Data](#).

Introduction

This article applies to installing components on machines with Windows operating systems. For information about VDAs for Linux operating systems, see [Linux Virtual Delivery Agents](#).

This article describes how to issue product installation commands. Before beginning any installation, review [Prepare to install](#). That article includes descriptions of the available installers.

To see command execution progress and return values, you must be the original administrator or use **Run as administrator**. For more information, see the Microsoft command documentation.

As a complement to using the installation commands directly, sample scripts are provided on the product ISO that install, upgrade, or remove VDAs on machines in Active Directory. For details, see [Install VDAs using scripts](#).

If you attempt to install or upgrade on a Windows OS version that is not supported for this Citrix Virtual Apps and Desktops version, a message guides you to information about your options. See [Earlier operating systems](#).

For information about how Citrix reports the results of component installations, see [Citrix installation return codes](#).

Use the full-product installer

To access the full product installer's command-line interface:

1. Download the product package from Citrix. Citrix account credentials are required to access the download site.
2. Unzip the file. Optionally, burn a DVD of the ISO file.
3. Log on to the server where you are installing the components, using a local administrator account.
4. Insert the DVD in the drive or mount the ISO file.
5. From the `\x64\XenDesktop Setup` directory on the media, run the appropriate command.

To install core components: Run `XenDesktopServerSetup.exe`, with the options listed in Command-line options for installing core components.

To install a VDA: Run `XenDesktopVDASetup.exe` with the options listed in Command-line options for installing a VDA.

To install StoreFront: Run `CitrixStoreFront-x64.exe` in the `x64 > StoreFront` folder on the installation media.

To install the Universal Print Server: Follow the guidance in Command-line options for installing a Universal Print Server.

To install the Federated Authentication Service: Citrix recommends using the graphical interface.

To install Session Recording: Follow the guidance in [Session Recording](#).

To install Workspace Environment Management: Follow the guidance in [Workspace Environment Management](#).

To install Secure Private Access: Run `XenDesktopSPASetup.exe` in the `x64 > XenDesktop Setup` folder on the installation media. Follow the guidance in [Command-line options for installing a Secure Private Access](#).

Command-line options for installing core components

The following parameter options are valid when installing core components with the `XenDesktopServerSetup.exe` command. For more detail about options, see [Install core components](#).

- **/ceipoptin** *ceipoptin* [,*ceipoptin*] ...

Enables collection of Call Home data and Customer Experience Improvement Program (CEIP) data. Valid values are:

- **DIAGNOSTIC**: Choose this value to enable Citrix Licensing to collect Call Home data.
- **ANONYMOUS**: Choose this value to enable Citrix Licensing to collect unidentified CEIP data (which does not identify users).
- **NONE**: Choose this value to disable Citrix Licensing collection of CEIP data.

For more information about Call Home data collection, see [Citrix Licensing Call Home](#).

For more details about CEIP data collection, see [Citrix Licensing Customer Experience Improvement Program](#).

For more details about CEIP data, see [Citrix Licensing CEIP data elements](#).

For more details about License Server licensing data, see [Citrix Licensing Data](#).

- **/components** *component* [,*component*] ...

Comma-separated list of components to install or remove. Valid values are:

- **CONTROLLER**: Controller
- **DESKTOPSTUDIO**: Studio
- **WEBSTUDIO**: Web Studio
- **DESKTOPDIRECTOR**: Director
- **LICENSESERVER**: Citrix License Server
- **SECUREPRIVATEACCESS**: Secure Private Access

If this option is omitted, all components are installed (or removed, if the `/remove` option is also specified).

(In releases before 2003, valid values included **STOREFRONT**. For version 2003 and later, use the dedicated StoreFront installation command mentioned in [Use the full-product installer](#)).

- **/configure_firewall**

Opens all ports in the Windows firewall used by the components being installed, if the Windows Firewall Service is running, even if the firewall is not enabled. If you are using a third-party firewall or no firewall, you must manually open the ports.

- **/disableexperiencemetrics**

Prevents automatic upload of analytics collected during installation, upgrade, or removal to Citrix.

- **/exclude** “feature”[,”feature”]

Prevents installation of one or more comma-separated features, services, or technologies, each enclosed in straight quotation marks. Valid values are:

- **"Local Host Cache Storage (LocalDB)"**: Prevents installation of the database used for Local Host Cache. This option has no effect on whether SQL Server Express is installed for use as the site database.

- **/help** or **/h**

Displays command help.

- **/ignore_hw_check_failure**

Allows the Delivery Controller installation or upgrade to continue, even if the hardware checks fail (for example, due to insufficient RAM). For more information, see [Hardware check](#).

- **/ignore_site_test_failure**

Valid only during Controller upgrade. Usually, any site test failures are ignored and the upgrade proceeds. If omitted (or set to false), any site test failure causes the installer to fail, without performing the upgrade. Default = false

During an upgrade, this option is ignored if an unsupported SQL Server version is detected. For details, see [SQL Server version check](#).

- **/installdir directory**

Existing empty directory where components will be installed. Default = c:\Program Files\Citrix.

- **/logpath path**

Log file location. The specified folder must exist. The installer does not create it. Default = TEMP%\Citrix\XenDesktop Installer

- **/no_remote_assistance**

Valid only when installing the Director. Disables the user shadowing feature that uses Windows Remote Assistance.

- **/noreboot**

Prevents a restart after installation. (For most core components, a restart is not enabled by default.)

- **/noresume**

By default, when a machine restart is needed during an installation, the installer resumes automatically after the restart completes. To override the default, specify **/noresume**. This can

be helpful if you must remount the media or want to capture information during an automated installation.

- **/nosql**

Prevents the installation of Microsoft SQL Server Express on the server where you are installing the Controller. If this option is omitted, SQL Server Express is installed for use as the site database.

This option does not affect the installation of SQL Server Express LocalDB used for Local Host Cache.

- **/quiet** or **/passive**

No user interface appears during the installation. The only evidence of the installation process is in Windows Task Manager. If this option is omitted, the graphical interface launches.

- **/remove**

Removes the core components specified with the `/components` option.

- **/removeall**

Removes all installed core components.

- **/sendexperiencemetrics**

Automatically sends analytics collected during the installation, upgrade, or removal to Citrix. If this option is omitted (or `/disableexperiencemetrics` is specified), the analytics are collected locally, but not sent automatically.

- **/tempdir** *directory*

Directory that holds temporary files during installation. Default = `c:\Windows\Temp`.

- **/xenapp**

Installs Citrix Virtual Apps. If this option is omitted, Citrix Virtual Apps and Desktops is installed.

Examples of installing core components

The following command installs a Delivery Controller, Studio, Citrix Licensing, and SQL Server Express on a server. Firewall ports required for component communications are opened automatically.

```
\x64\XenDesktop Setup\XenDesktopServerSetup.exe /components controller ,desktopstudio,licenseserver /configure_firewall
```

The following command installs a Citrix Virtual Apps Controller, Studio, and SQL Server Express on the server. Firewall ports required for component communication are opened automatically.

```
\x64\XenDesktop Setup\XenDesktopServerSetup.exe /xenapp /components controller,desktopstudio /configure_firewall
```

The following command installs a Delivery Controller, Secure Private Access, and SQL Server Express on a server. Firewall ports required for component communication are opened automatically.

```
\x64\XenDesktop Setup XenDesktopServerSetup.exe /xenapp /components controller,secureprivateaccess /configure_firewall
```

Use a standalone VDA installer

Citrix account credentials are required to access the download site. You must either have elevated administrative privileges before starting the installation, or use **Run as administrator**.

1. Download the appropriate package from Citrix:
 - Multi-session OS Virtual Delivery Agent: `VDAServerSetup_xxxx.exe`
 - Single-session OS Virtual Delivery Agent: `VDAWorkstationSetup_xxxx.exe`
 - Single-session OS Core Services Virtual Delivery Agent: `VDAWorkstationCoreSetup_xxxx.exe`
2. Either extract the files from the package to an existing directory first and then run the installation command, or simply run the package.

To extract the files before installing them, use `/extract` with the absolute path, for example `C:\YourExtractFolder\VDAWorkstationCoreSetup.exe /extract %temp%\CitrixVDAInstallMedia`. The directory must exist. Otherwise, the extract fails. Then in a separate command, run the appropriate command, using the valid options listed in this article.

- For `VDAServerSetup_XXXX.exe`, run `<extract folder>\Extract\Image-Full\x64\XenDesktop Setup\XenDesktopVDASetup.exe`
- For `VDAWorkstationCoreSetup_XXXX.exe`, run `<extract folder>\Extract\Image-Full\x64\XenDesktop Setup\XenDesktopRemotePCSetup.exe`
- For `VDAWorkstationSetup_XXXX.exe`, run `<extract folder>\Extract\Image-Full\x64\XenDesktop Setup\XenDesktopVDASetup.exe`

To run the downloaded package, run its name: `VDAServerSetup.exe`, `VDAWorkstationSetup.exe`, or `VDAWorkstationCoreSetup.exe`. Use the valid options listed in this article.

If you are familiar with the full product installer:

- Run the standalone `VDAServerSetup.exe` or `VDAWorkstationSetup.exe` installer as if it was the `XenDesktopVdaSetup.exe` command in everything except its name.

- The `VDAWorkstationCoreSetup.exe` installer is different, because it supports a subset of the options available to the other installers.

Command-line options for installing a VDA

The following options are valid with one or more of the following commands (installers): `VDAServerSetup_xxxx.exe`, `VDAWorkstationSetup_xxxx.exe`, and `VDAWorkstationCoreSetup.exe`.

For more details about options, see [Install VDAs](#).

- **`/components`** *component[,component]*

Comma-separated list of components to install or remove. Valid values are:

- `VDA`: Virtual Delivery Agent
- `PLUGINS`: Citrix Workspace app for Windows

To install the VDA and Citrix Workspace app for Windows, specify `/components vda, plugins`.

If this option is omitted, only the VDA is installed (not the Citrix Workspace app).

This option is not valid when using the `VDAWorkstationCoreSetup_xxxx.exe` installer. That installer cannot install the Citrix Workspace app.

- **`/controllers`** “*controller [controller]*”

Space-separated FQDNs of Controllers with which the VDA can communicate, enclosed in straight quotation marks. Do not specify both the `/site_guid` and `/controllers` options.

- **`/disableexperiencemetrics`**

Prevents the automatic upload of analytics collected during installation, upgrade, or removal to Citrix.

- **`/enable_hdx_ports`**

Opens ports in the Windows firewall required by the VDA and enabled features (except Windows Remote Assistance), if the Windows Firewall Service is detected, even if the firewall is not enabled. If you are using a different firewall or no firewall, you must configure the firewall manually. For port information, see [Network ports](#).

To open the UDP ports that HDX adaptive transport uses, specify the `/enable_hdx_udp_ports` option, in addition to this `/enable_hdx_ports` option.

- **/enable_hdx_udp_ports**

Opens UDP ports in the Windows firewall that HDX adaptive transport uses, if the Windows Firewall Service is detected, even if the firewall is not enabled. If you are using a different firewall or no firewall, you must configure the firewall manually. For port information, see [Network ports](#).

To open extra ports that the VDA uses, specify the `/enable_hdx_ports` option, in addition to this `/enable_hdx_udp_ports` option.

- **/enable_hdx_tls_dtls**

Opens TCP and UDP port 443 for HDX Direct V1.

- **/enable_real_time_transport**

Enables or disables the use of UDP for audio packets (RealTime Audio Transport for audio). Enabling this feature can improve audio performance. Include the `/enable_hdx_ports` option if you want the UDP ports opened automatically when the Windows Firewall Service is detected.

- **/enable_remote_assistance**

Enables the shadowing feature in Windows Remote Assistance for use with Director. If you specify this option, Windows Remote Assistance opens the dynamic ports in the firewall.

- **/enablerestore** or **/enablerestorecleanup**

(Valid only for single-session VDAs) Enables automatic return to the restore point, if the VDA install or upgrade fails.

If the install/upgrade completes successfully:

- `/enablerestorecleanup` instructs the installer to remove the restore point.
- `/enablerestore` instructs the installer to retain the restore point, even though it was not used.

For details, see [Restore on install or upgrade failure](#).

- **/enable_ss_ports**

Opens ports in the Windows Firewall that are required for screen sharing, if the Windows Firewall Service is detected, even if the firewall is not enabled. If you are using a different firewall or no firewall, you must configure the firewall manually.

- **/exclude** *“component”[,”component”]*

Prevents the installation of one or more comma-separated optional components, each enclosed in straight quotation marks. For example, installing or upgrading a VDA on an image that is not managed by MCS does not require the Machine Identity Service component. Valid values are as follows:

Multi-session OS	Single-session OS	Single-session OS Core Services
Citrix Authentication Identity Assertion VDA Plug-in	Citrix Authentication Identity Assertion VDA Plug-in	Citrix Authentication Identity Assertion VDA Plug-in
Citrix Backup and Restore	Citrix Backup and Restore	Citrix Browser Content Redirection
Citrix Browser Content Redirection	Citrix Browser Content Redirection	Citrix Personalization for App-V - VDA
Citrix MCS IODriver	Citrix MCS IODriver	Citrix Telemetry Service
Citrix Personalization for App-V - VDA	Citrix Personalization for App-V - VDA	Citrix Universal Print Client
Citrix Profile Management	Citrix Profile Management	Citrix Vda Log Capture Service
Citrix Profile Management WMI Plug-in	Citrix Profile Management WMI Plug-in	CSE Component
Citrix Rendezvous V2	Citrix Rendezvous V2	Director VDA Plug-in
Citrix Telemetry Service	Citrix Telemetry Service	Machine Management Provider
Citrix Universal Print Client	Citrix Universal Print Client	VDA Monitor Plug-in
Citrix Vda Log Capture Service	Citrix Vda Log Capture Service	VDA WMI Proxy Plug-in
Citrix VDA Upgrade Agent	Citrix VDA Upgrade Agent	
CSE Component	CSE Component	
Director VDA Plug-in	Director VDA Plug-in	
Machine Identity Service	Machine Identity Service	

Multi-session OS	Single-session OS	Single-session OS Core Services
Machine Management Provider	Machine Management Provider	
VDA Monitor Plug-in	User Personalization Layer	
VDA WMI Proxy Plug-in	VDA Monitor Plug-in VDA WMI Proxy Plug-in	
Citrix App Protection Component	Citrix App Protection Component	Citrix App Protection Component
Citrix HyperV Filter Driver	Citrix HyperV Filter Driver	
Citrix Personalization for App-V - VDA	Citrix Personalization for App-V - VDA	Citrix Personalization for App-V - VDA

Excluding Citrix Profile Management from the installation (`/exclude "Citrix Profile Management"`) affects monitoring and troubleshooting of VDAs with Citrix Director. On the **User details** and **EndPoint** pages, the Personalization panel and the Logon Duration panel fail. On the **Dashboard** and **Trends** pages, the Average Logon Duration panel displays data only for machines that have Profile Management installed.

Even if you are using a third-party user profile management solution, Citrix recommends that you install and run the Citrix Profile Management Service. Enabling the Citrix Profile Management Service is not required.

If you specify both `/exclude` and `/includeadditional` with the same component name, that component is not installed.

This option is not valid when using the `VDAWorkstationCoreSetup.exe` installer. That installer automatically excludes many of these items.

- **`/h` or `/help`**

Displays command help.

- **`/includeadditional` `"component"`[`,"component"`]**

Includes installation of one or more comma-separated optional components, each enclosed in straight quotation marks. This option can be helpful when you are creating a Remote PC Access

deployment, and want to install other components that are not included by default. Valid values are as follows:

Multi-session OS	Single-session OS
Citrix Backup and Restore	Citrix Backup and Restore
Citrix MCS IODriver	Citrix MCS IODriver
Citrix Personalization for App-V - VDA	Citrix Personalization for App-V - VDA
Citrix Profile Management	Citrix Profile Management
Citrix Profile Management WMI Plug-in	Citrix Profile Management WMI Plug-in
Citrix Rendezvous V2	Citrix Rendezvous V2
Citrix VDA Upgrade Agent	Citrix VDA Upgrade Agent
Citrix Web Socket Vda Registration Tool	Citrix Web Socket Vda Registration Tool
Machine Identity Service	Machine Identity Service
	User Personalization Layer

If you specify both `/exclude` and `/includeadditional` with the same component name, that component is not installed.

- **`/installdir`** *directory*

Existing empty directory where components will be installed. Default = `c:\Program Files\Citrix`.

- **`/install_mcsio_driver`**

Do not use. Instead, use `/includeadditional "Citrix MCS IODriver"` or `/exclude "Citrix MCS IODriver"`

- **`/logpath`** *path*

Log file location. The specified folder must exist. The installer does not create it. Default = `"%TEMP%\Citrix\XenDesktop Installer"`

This option is not available in the graphical interface.

- **`/masterimage`**

Valid only when installing a VDA on a VM. Sets up the VDA as an image to be used to create other machines. This option is equivalent to `/mastermcsimage`.

This option is not valid when using the `VDAWorkstationCoreSetup_xxxx.exe` installer.

- **/mastermcsimage**

Specifies that this machine will be used as an image with Machine Creation Services. This option is equivalent to `/masterimage`.

- **/masterpvsimage**

Specifies that this machine will be used as an image with either Citrix Provisioning or a third-party provisioning tool (such as Microsoft System Center Configuration Manager) to provision VMs.

- **/websockettoken** *WebSocketToken*

Creates a Web Socket VDA. The `WebSocketToken` is for the token that is required.

- **/no_mediafoundation_ack**

Acknowledges that Microsoft Media Foundation is not installed, and several HDX multimedia features will not be installed and will not work. If this option is omitted and Media Foundation is not installed, the VDA installation exits since the pre-conditions are not met. Most supported Windows editions come with Media Foundation already installed, except N editions. If you enable Windows Features > Media Features *manually*, the registry key sought by the Citrix Meta Installer may not have a set value. Check the `SOFTWARE\Microsoft\Windows\CurrentVersion\Setup\Windows-Features\WindowsMediaVersion` registry key before starting the install process to confirm the value exists and is not empty.

- **/nodesktopexperience**

The Enhanced Desktop Experience feature is no longer available. This option (and policy setting) is ignored, if specified.

Valid only when installing a VDA for multi-session OS. Prevents enabling of the Enhanced Desktop Experience feature. This feature is also controlled with the Enhanced Desktop Experience Citrix policy setting.

- **/noreboot**

Prevents a restart after installation. The VDA cannot be used until after a restart.

- **/noresume**

By default, when a machine restart is needed during an installation, the installer resumes automatically after the restart completes. To override the default, specify `/noresume`. This can be helpful if you must remount the media or want to capture information during an automated installation.

- **/physicalmachine**

Use this argument along with `/remotepc` for RemotePC installation. Otherwise the VDA might not behave as expected in certain user scenarios.

- **/portnumber** *port*

Valid only when the `/reconfig` option is specified. Port number to enable for communications between the VDA and the Controller. The previously configured port is disabled, unless it is port 80.

- **/proxyconfig** “*address or PAC file path*”

If you plan to use the Rendezvous protocol with Gateway Service, VDA Upgrade Service, etc, in your environment and have a non-transparent proxy in your network for outbound connections, specify the proxy here. Only HTTP proxies are supported. The address or PAC file path of the proxy for use with the Rendezvous protocol. For feature details, see [Rendezvous protocol](#).

- Proxy address format: `http://<url-or-ip>:<port>`
- PAC file format: `http://<url-or-ip>:<port>/<path>/<filename>.pac`

- **/quiet** or **/passive**

No user interface appears during the installation. The only evidence of the installation and configuration process is in Windows Task Manager. If this option is omitted, the graphical interface launches.

- **/reconfigure**

Customizes previously configured VDA settings when used with the `/portnumber`, `/controllers`, or `/enable_hdx_ports` options. If you specify this option without also specifying the `/quiet` option, the graphical interface for customizing the VDA launches.

- **/remotepc**

Valid only for Remote PC Access deployments (single-session OS) or brokered connections (multi-session OS). Excludes installation of any additional components (see component lists with `/exclude` and `/includeadditional` options).

This option is not valid when using the `VDAWorkstationCoreSetup.exe` installer. That installer automatically excludes installation of these components.

`/remotepc` is not compatible with the `/servervdi` option.

- **/remove**

Removes the components specified with the `/components` option.

- **/remove_appdisk_ack**

Authorizes the VDA installer to uninstall the AppDisks VDA plug-in if it's installed.

- **/remove_pvd_ack**

Authorizes the VDA installer to uninstall Personal vDisk if it's installed.

- **/removeall**

Removes the VDA. It does not remove the Citrix Workspace app (if installed).

- **/REMOVEALLWITHCWA**

Removes CWA along with the VDA.

- **/sendexperiencemetrics**

Automatically sends analytics collected during the installation, upgrade, or removal to Citrix. If this option is omitted (or the `/disableexperiencemetrics` option is specified), analytics are collected locally, but not sent automatically.

- **/servervdi**

Installs a VDA for single-session OS on a supported Windows multi-session machine. Omit this option when installing a VDA for multi-session OS on a Windows multi-session machine.

Before using this option, see [Server VDI](#).

Use this option only with the full-product VDA installer.

- **/site_guid** *guid*

Globally Unique Identifier of the site Active Directory Organizational Unit (OU). This associates a virtual desktop with a site when you are using Active Directory for discovery (auto-update is the recommended and default discovery method). The site GUID is a site property displayed in Studio. Do not specify both the `/site_guid` and `/controllers` options.

- **/tempdir** *directory*

Directory to hold temporary files during installation. Default = c:\Windows\Temp.

This option is not available in the graphical interface.

- **/virtualmachine**

Valid only when installing a VDA on a VM. Overrides detection by the installer of a physical machine, where BIOS information passed to VMs makes them appear as physical machines.

This option is not available in the graphical interface.

- **/xendesktopcloud**

Indicates that the VDA is installed in a Citrix DaaS (Citrix Cloud) deployment.

Examples of installing a VDA

Install a VDA with the full-product installer:

The following command installs a VDA for single-session OS and Citrix Workspace app to the default location on a VM. This VDA will be used as an image and use MCS to provision VMs. The VDA will register

initially with the Controller on the server named `Contr-Main` in the domain `mydomain`. The VDA will use user personalization layer and Windows Remote Assistance.

```
\x64\XenDesktop Setup\XenDesktopVdaSetup.exe /quiet /components vda ,plugins /controllers "Contr-Main.mydomain.local"/enable_hdx_ports /includeadditional "user personalization layer"/mastermcsimage /enable_remote_assistance
```

Install a single-session OS VDA with the VDAWorkstationCoreSetup standalone installer:

The following command installs a Core Services VDA on a single-session OS for use in a Remote PC Access or VDI deployment. Citrix Workspace app and other non-core services are not installed. The address of a Controller is specified, and ports in the Windows Firewall Service will be opened automatically. The administrator will handle restarts.

```
VDAWorkstationCoreSetup .exe /quiet /controllers "Contr-East.domain.com"/enable_hdx_ports /noreboot
```

Customize a VDA

After you install a VDA, you can customize several settings. From the `\x64\XenDesktop Setup` directory on the product media, run `XenDesktopVdaSetup.exe`, using one or more of the following options, which are described in Command-line options for installing a VDA.

- `/reconfigure` (required when customizing a VDA)
- `/h` or `/help`
- `/quiet`
- `/noreboot`
- `/controllers`
- `/portnumber port`
- `/enable_hdx_ports`

Troubleshoot VDAs

- In the Studio display for a delivery group, the **Installed VDA version** entry in the **Details** pane might not be the version installed on the machines. The machine's Windows Programs and Features display shows the actual VDA version.
- After a VDA is installed, it cannot deliver apps or a desktop to users until it registers with a Delivery Controller.

To learn about VDA registration methods and how to troubleshoot registration issues, see [VDA registration](#).

Command-line options for installing a Universal Print Server

The following option is valid with the `XenDesktopPrintServerSetup.exe` command.

- **`/enable_upsserver_port`**

When this option is not specified, the installer displays the **Firewall** page from the graphical interface. Select **Automatically** to have the installer automatically add the Windows firewall rules, or **Manually** to let the administrator manually configure the firewall.

After installing the software on your print servers, configure the Universal Print Server using the guidance in [Provision printers](#).

Command-line options for installing a Secure Private Access

The following options are valid with the following command (installer): `XenDesktopSPASetup.exe`

- **`/enable_spa_ports`**

Opens ports in the Windows firewall required by the Secure Private Access, if the Windows Firewall Service is detected, even if the firewall is not enabled. If you are using a different firewall or no firewall, you must configure the firewall manually. For port information, see [Network ports](#).

- **`/nosql`**

Prevents the installation of Microsoft SQL Server Express on the server where you are installing the Secure Private Access. If this option is omitted, SQL Server Express is installed for use as the site database.

- **`/help or /h or /?`**

Displays command help

- **`/noreboot`**

Prevents a restart after installation. Secure Private Access cannot be used until after a restart.

- **`/quiet or /passive`**

No user interface appears during the installation. The only evidence of the installation and configuration process is in Windows Task Manager. If this option is omitted, the graphical interface launches.

- **`/remove`**

Removes the Secure Private Access.

For more details about the options, see [Secure Private Access installer](#).

More information

For information about how Citrix reports the result of component installations, see [Citrix installation return codes](#).

Install Web Studio

March 13, 2024

License requirements:

To use Web Studio, you need to have one of the following license types:

- [Citrix Universal Subscription License](#).
- [Citrix on-premises subscription for annual and term-based retail licenses](#).
- Any on-premises license for Citrix Service Providers (CSP).

Introduction

Citrix Studio is a Windows-based management console that lets you configure and manage your Citrix Virtual Apps and Desktops deployment. Web Studio is the next generation of Citrix Studio—a web-based management console offering full feature parity with Citrix Studio. With the same look and feel as the [Citrix DaaS Full Configuration interface](#), Web Studio modernizes your management experience by providing a native web experience.

You can deploy Web Studio to any Windows server with Internet Information Service (IIS) installed. For quick deployment, we recommend that you install Web Studio along with a Delivery Controller. In that case, Web Studio is installed as a website on the Delivery Controller. We recommend that you follow this setup for simple architecture and less management overhead. The following diagram shows the Web Studio architecture:

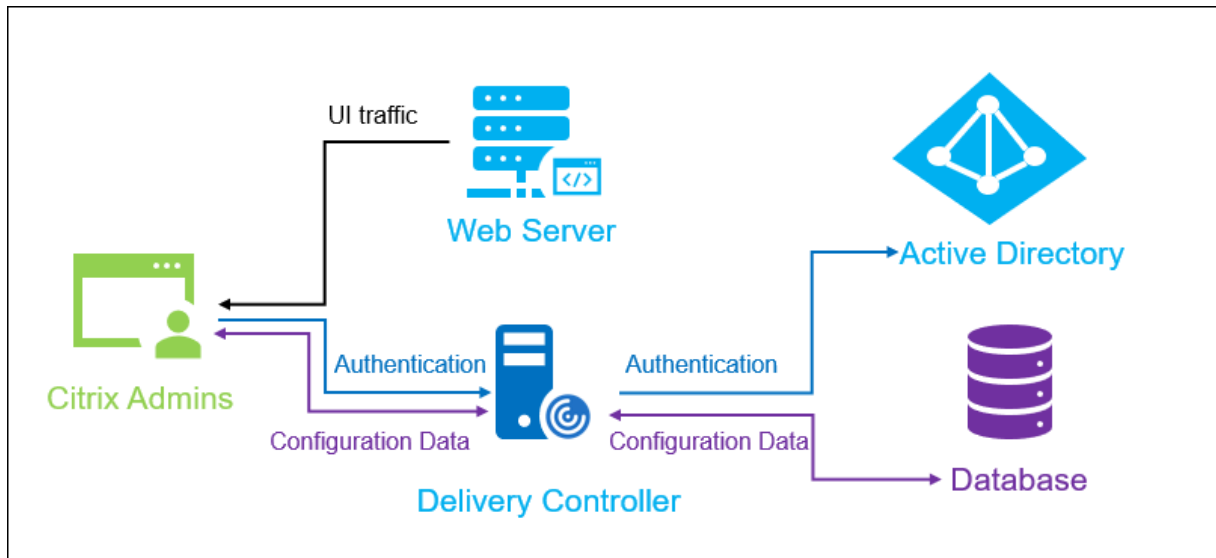

A general workflow to get Web Studio up and running is as follows:

1. Install Web Studio.
2. Set up a site.
3. Add Delivery Controllers to Web Studio for management.
4. Log on to Web Studio.

To set up a load-balanced Web Studio deployment, see [this article](#).

New features available in Web Studio

See the [What's new](#) article.

System requirements

Supported operating systems:

- Windows Server 2022
- Windows Server 2019, Standard and Datacenter Editions, and with the Server Core option
- Windows Server 2016, Standard and Datacenter Editions, and with the Server Core option
- Windows 11
- Windows 10

Supported browsers:

- Internet Explorer 11
 - Compatibility mode is not supported for Internet Explorer. Use the default settings to access Web Studio.
 - When you install Internet Explorer, accept the default to use the recommended security and compatibility settings. If you've already installed the browser and chose not to use the recommended settings, go to **Tools > Internet Options > Advanced > Reset** and follow the instructions.
- Microsoft Edge
- Firefox ESR (Extended Support Release)
- Chrome

The recommended optimal screen resolution for viewing Web Studio is 1440 x 1024.

Prerequisites

This release of Web Studio is compatible with Citrix Virtual Apps and Desktops 2212 deployments and later.

For deployments earlier than 2212, first upgrade to 2212 and then install Web Studio.

Known limitations

If you use Web Studio and Citrix Studio interchangeably, consider the following limitation: A template created in Web Studio is not shown in Citrix Studio, and vice versa. This is because Web Studio uses a database different from Citrix Studio to store templates. As a workaround, create a policy from a template in Web Studio and then create a template from this policy in Citrix Studio, and vice versa.

- To ensure a successful installation of Web Studio, do not change the default site name (**Default Web Site**) in Internet Information Services (IIS) Manager. Any changes to the default site name result in installation failures.

Install Web Studio

The following information is a supplement to the guidance in [Install core components](#). To install Web Studio:

- Install Web Studio using the full product ISO installer for Citrix Virtual Apps and Desktops. The ISO installer checks for prerequisites, installs any missing components, sets up the Web Studio

website (on the Delivery Controller if included in Delivery Controller installation), and performs basic configuration.

- If Web Studio was not included during installation, use the installer to add Web Studio.
- When installing Web Studio, you are prompted to type the address of a Delivery Controller.

Note:

- You can add more than one Delivery Controller. Web Studio attempts to connect to them in random order. If the Delivery Controller to which Web Studio is attempting to connect is unreachable, Web Studio automatically falls back to other Delivery Controllers.
- If Director was selected in **Core Components** and installed, the Delivery Controllers you add here are used for both Web Studio and Director.
- If you don't have the external public trust certificate configured and don't want to request the certificate from an enterprise CA, you just need to configure the FQDN of your Delivery Controller.
- If you have the external public trust certificate and can configure the public DNS for your Delivery Controller, you can type the DNS name as the Delivery Controller address.
- If you can request the certificate from your enterprise CA and can specify your personal DNS, you can add your personal DNS as the Delivery Controller address.

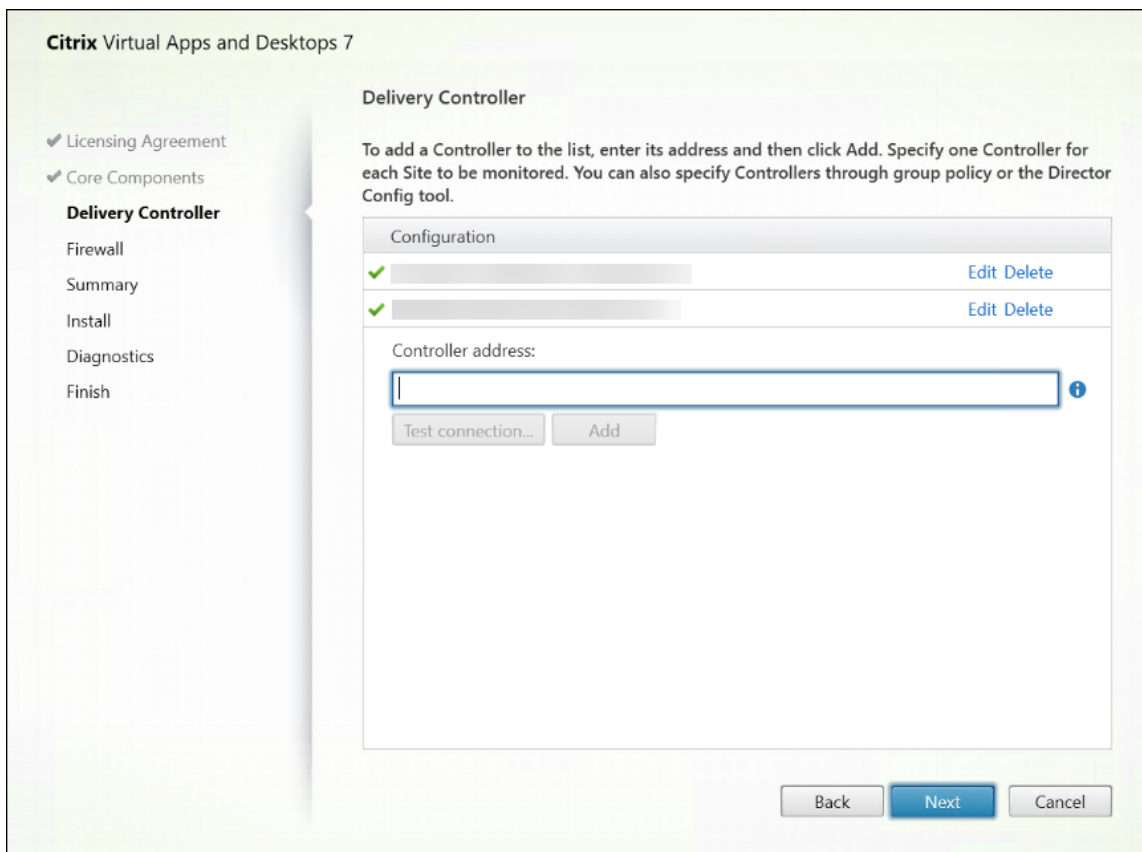

- To secure the communications between the browser and the web server and between the browser and the Delivery Controller, TLS encryption must be enabled on the IIS website hosting Web Studio and on the Delivery Controller. If no TLS certificate is configured for the Delivery Controller, the installer creates a self-signed certificate, with the FQDN of the Delivery Controller and localhost as the DNS name certificate. If a TLS certificate is configured, the installer doesn't make any change. For more information about TLS encryption, see [Secure a Web Studio deployment \(optional\)](#).
- On the **Finish** page, the **Launch Site Manager** check box is selected by default so that the Citrix Site Manager opens automatically. To launch it later, open your desktop Start menu and select **Citrix > Citrix Site Manager**. Before you launch Web Studio, you need to use the Citrix Site Manager to create a site or join an existing site. For more information, see [Set up a site](#).

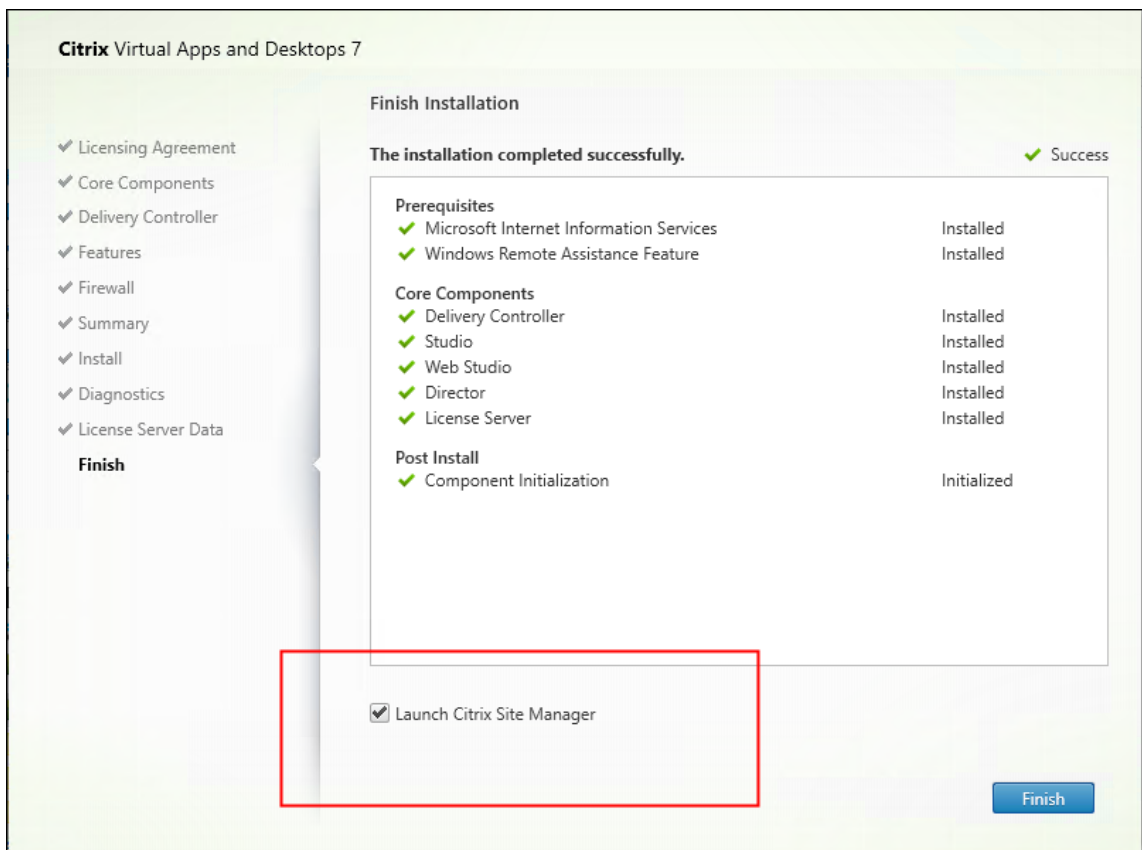
**Note:**

You can also use the command line to install Web Studio. Example: `.\XenDesktopServerSetup.exe /components webstudio /controllers "ddc1.studio.local"/configure_firewall /quiet`. For more information, see [Install using the command line](#).

Set up a site

To set up your Citrix Virtual Apps and Desktops deployment (also known as a site), use the tool, Citrix Site Manager. The tool is installed automatically with a Delivery Controller.

To set up a site, follow these steps:

1. On a Delivery Controller, open the desktop Start menu, and then select **Citrix > Citrix Site Manager**.
2. In the Citrix Site Manager, select **Create a site**. The Site Setup wizard appears.
3. Create a site and configure its settings as follows:
 - On the **Introduction** page, type a name for the site.

- The **Databases** page contains selections for setting up the site, monitoring, and configuration logging databases. For more information, see [Step 3. Databases](#).
 - On the **Licensing** page, specify the License Server address and then indicate which license to use (install). For more information, see [Step 4. Licensing](#).
4. On the **Summary** page, check all settings and click **Submit**.

The IP address of this Controller is automatically added to the site.

Note:

The user who creates a site becomes a full administrator for it. For more information, see [Delegated administration](#).

If you install a new Controller after creating a site, you must add the Controller to the site. Detailed steps are as follows:

1. Run Citrix Site Manager on this new Controller.
2. Select **Join an existing site**.
3. Type the address of a Controller that is already added to the site.
4. Click **Submit**.

Add Delivery Controllers to Web Studio for management

Use the Studio configuration tool to add the Delivery Controllers to Web Studio for management. This tool is available in the Web Studio installation folder.

By default, the tool is installed in the following default folder.

- `C:\Program Files\Citrix\Web Studio\Tool\StudioConfig.exe`

Suppose you want to configure the following two Delivery Controllers for the site that you want to manage with Web Studio: `ddc1.studio.local` and `ddc2.studio.local`. Run the following PowerShell command:

- `.\StudioConfig.exe --server "ddc1.studio.local,ddc2.studio.local"`

Note:

- The tool requires computer administrator permissions.
- The Delivery Controller configuration changes might not take effect immediately due to cache settings on the IIS server. For immediate effect, go to the Web Studio server, open Internet Information Services (IIS) Manager, navigate to Start Page > Sites > Default Web Site,

and select **Restart** in the Manage Website pane.

- To view all supported parameters, run `StudioConfig.exe --help`.

Configure Web Studio as a proxy for Delivery Controllers (optional)

By default, when you manage your deployment using the Web Studio console, you connect to both the Web Studio server and the Delivery Controllers through the web browser. We provide you with an option to configure the Web Studio server as a proxy for Delivery Controllers. As a result, you connect only to the Web Studio server when managing your deployment.

This section guides you to configure a Web Studio server as a proxy for Delivery Controllers. We assume that Web Studio and Delivery Controllers are installed on different servers.

Before you start, verify that you have all necessary core components installed in your deployment. For more information, see [Install core components](#).

To enable proxy mode for Web Studio, follow these steps:

1. On the Web Studio server, run Windows PowerShell as an administrator.
2. Run the following command where you replace `fqdn_of_webstudio_machine` with the FQDN of your Web Studio server.

```
& "c:\Program Files\Citrix\Web Studio\Tool\StudioConfig.exe"--  
enableproxy --proxyserver "fqdn_of_webstudio_machine"
```

To disable proxy mode for Web Studio, run this PowerShell command:

```
1 `& "c:\Program Files\Citrix\Web Studio\Tool\StudioConfig.exe" --  
disableproxy`
```

Note:

As a best practice, we recommend that you secure your Web Studio deployment by using an external public trust certificate or a certificate from an enterprise Certificate Authority (CA). For more information, see [Secure a Web Studio deployment](#).

Log on to Web Studio

The Web Studio website is located at `https://<address of the server hosting Web Studio>/Citrix/Studio`.

To log on to Web Studio, open your desktop Start menu and select **Citrix > Citrix Web Studio**. Administrators with permissions for Web Studio must be Active Directory domain users. When logging on to Web Studio, consider the following scenarios:

- If you have not yet specified Delivery Controllers for the site. You are prompted to specify a Delivery Controller so that you are provided with temporary access to Web Studio.
- If the specified Delivery Controllers are currently unreachable, you can't log on to Web Studio. Test your connections to make sure that those Delivery Controllers are reachable. Or specify an alternate Delivery Controller so that you are provided with temporary access to Web Studio.

Next steps

1. [Install VDAs](#)
2. Use Web Studio to deliver virtual apps and desktops to your users by:
 - a) [Creating a machine catalog](#)
 - b) [Creating a delivery group](#)
 - c) [Creating an application group \(optional\)](#)

Install VDAs

March 25, 2024

Important:

- If you're upgrading and your current version has the Personal vDisk or AppDisks software installed, see [Removing PvD, AppDisks, and unsupported hosts](#).
- Binaries distributed by Citrix are now signed. Signed binaries indicate that they are validated by either Citrix-generated certificates or authentic third-party certificates.

There are two types of VDAs for Windows machines: VDA for multi-session OS and VDA for single-session OS. (For information about VDAs for Linux machines, see the [Linux Virtual Delivery Agent](#) documentation.)

Before starting an installation, review [Prepare to install](#) and complete all preparation tasks.

Before installing VDAs, install the core components. You can also create the site before installing VDAs.

This article describes the installation wizard sequence when installing a VDA. Command-line equivalents are provided. For details, see [Install using the command line](#).

Step 1. Download the product software and launch the wizard

If you're using the full-product installer:

1. If you haven't downloaded the product ISO yet:
 - Use your Citrix account credentials to access the Citrix Virtual Apps and Desktops download page. Download the product ISO file.
 - Unzip the file. Optionally, burn a DVD of the ISO file.
2. Use a local administrator account on the image or machine where you're installing the VDA. Insert the DVD in the drive or mount the ISO file. If the installer does not launch automatically, double-click the **AutoSelect** application on the mounted drive.

The installation wizard launches.

If you're using a standalone package:

1. Use your Citrix account credentials to access the Citrix Virtual Apps and Desktops download page. Download the appropriate package:
 - [VDAServerSetup_2308.exe](#): Multi-session OS VDA *version*
 - [VDAWorkstationSetup_2308.exe](#): Single-session OS VDA *version*
 - [VDAWorkstationCoreSetup_2308.exe](#): Single-session OS Core Services VDA *version*
2. Right-click the package and choose **Run as administrator**.

The installation wizard launches.

Step 2. Choose which product to install

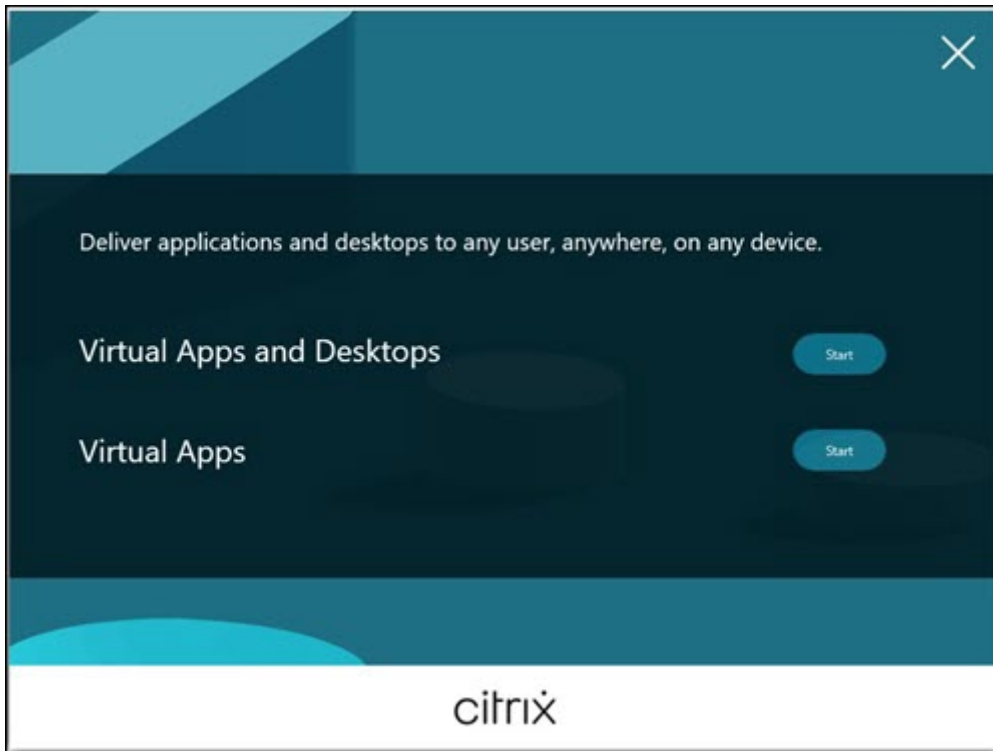

Click **Start** next to the product to install: Citrix Virtual Apps or Citrix Virtual Desktops. (If the machine already has a Citrix Virtual Apps or Citrix Virtual Desktops component installed, this page does not appear.)

Command-line option: `/xenapp` to install Citrix Virtual Apps. Citrix Virtual Desktops is installed if this option is omitted.

Step 3. Select the VDA

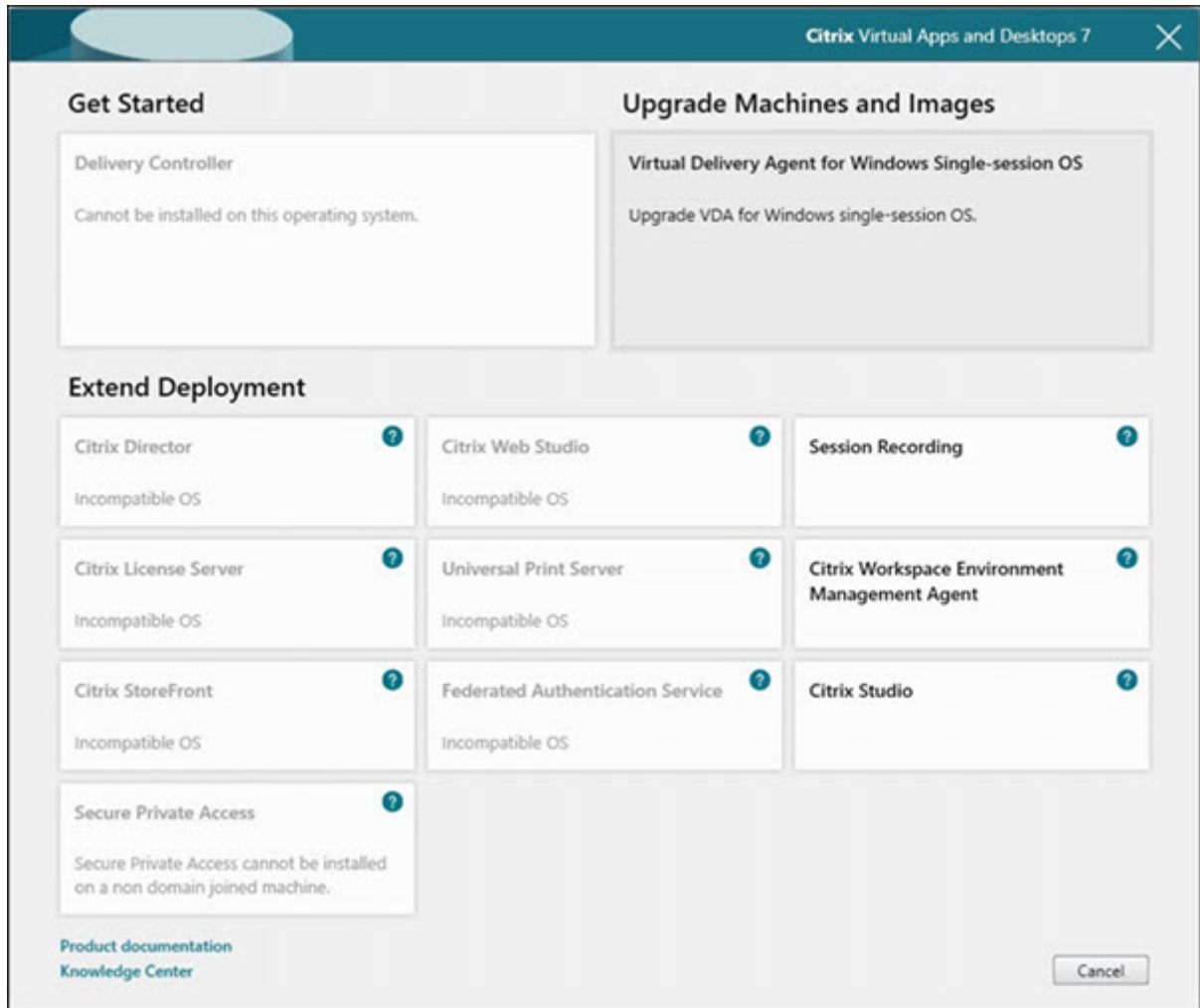

Select the **Virtual Delivery Agent** entry. The installer knows whether it's running on a single-session or multi-session OS, so it offers only the appropriate VDA type.

For example, when you run the installer on a Windows Server 2019 machine, the VDA for multi-session OS option is available. The VDA for single-session OS option is not offered.

If you try to install (or upgrade to) a Windows VDA on an OS that is not supported for this Citrix Virtual Apps and Desktops version, a message guides you to information about options.

Step 4. Specify how the VDA will be used

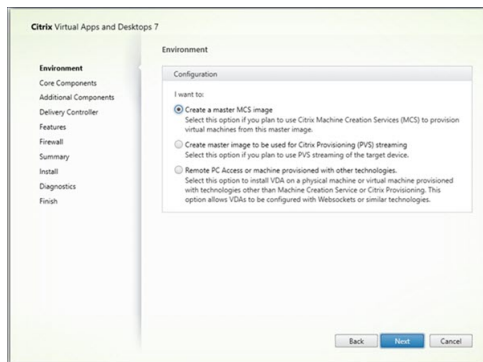

On the **Environment** page, specify how you plan to use the VDA, indicating whether you use this machine as an image to provision more machines.

The option you choose affects which Citrix Provisioning tools are installed automatically (if any), and the default values on the Additional Components page of the VDA installer.

Several MSIs (provisioning and other) are installed automatically when you install a VDA. The only way to prevent their installation is with the `/exclude` option in a command-line installation.

Choose one of the following:

- **Create a master MCS image:** Select this option to install a VDA on a VM image, if you plan to use Machine Creation Services to provision VMs. This option installs the Machine Identity Service. This is the default option.

Command-line option: `/mastermcsimage` or `/masterimage`

Important:

The installation media or ISO image must be mounted locally. Mounting an ISO image off a network drive for the purposes of installing software is not supported.

- **Create a master image using Citrix Provisioning or third-party provisioning tools:** Select this option to install a VDA on a VM image, if you plan to use either Citrix Provisioning or third-party provisioning tools (such as Microsoft System Center Configuration Manager) to provision VMs.

Command-line option: `/masterpvsimage`

- (Appears only on multi-session OS machines) **Enable brokered connections to a server:** Select this option to install a VDA on a physical or virtual machine that will not be used as an image to provision other machines.

Command-line option: `/remotepc`

- (Appears only on single-session OS machines) **Enable Remote PC Access:** Select this option to install a VDA on a physical machine for use with Remote PC Access.

Command-line option: `/remotepc`

Click **Next**.

This page does not appear:

- If you're upgrading a VDA
- If you are using the `VDAWorkstationCoreSetup_2308.exe`, `VDA ServerSetup_2308.exe`, or `VDAWorkstationSetup_2308.exe` installer

Step 5. Select the components to install and the installation location

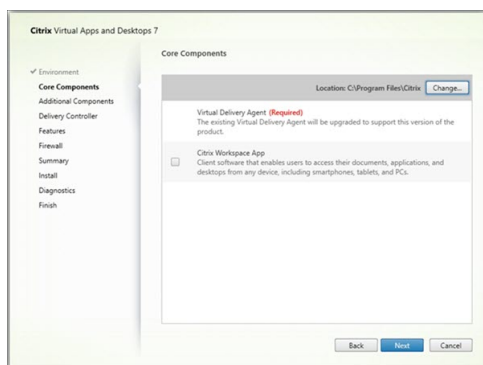

On the **Core components** page:

- **Location:** By default, components are installed in `C:\Program Files\Citrix`. This default is fine for most deployments. If you specify a different location, that location must have `execute` permissions for network service.
- **Components:** By default, Citrix Workspace app for Windows is not installed with the VDA. If you are using the `VDAWorkstationCoreSetup.exe` installer, Citrix Workspace app for Windows is never installed, so this check box is not displayed.

Click **Next**.

Command-line options: `/installdir`, `/components vda,plugin` to install the VDA and the Citrix Workspace app for Windows

Note:

You can choose to install, upgrade, or uninstall the Citrix Workspace App during a VDA installation, upgrade, or uninstallation in the following scenarios:

- During a VDA installation, you can choose to install the Citrix Workspace App. By default, Citrix Workspace app is not installed during the VDA installation.

- During a VDA upgrade, if Citrix Workspace app is not already installed in the VDA, you can choose to install Citrix Workspace App.
- During a VDA upgrade, if the version of Citrix Workspace app can be upgraded, then the option to upgrade Citrix Workspace app is displayed.
- During a VDA uninstallation, you can choose to not uninstall the Citrix Workspace App. By default, the Citrix Workspace app is uninstalled during the VDA uninstallation.

Step 6. Install additional components

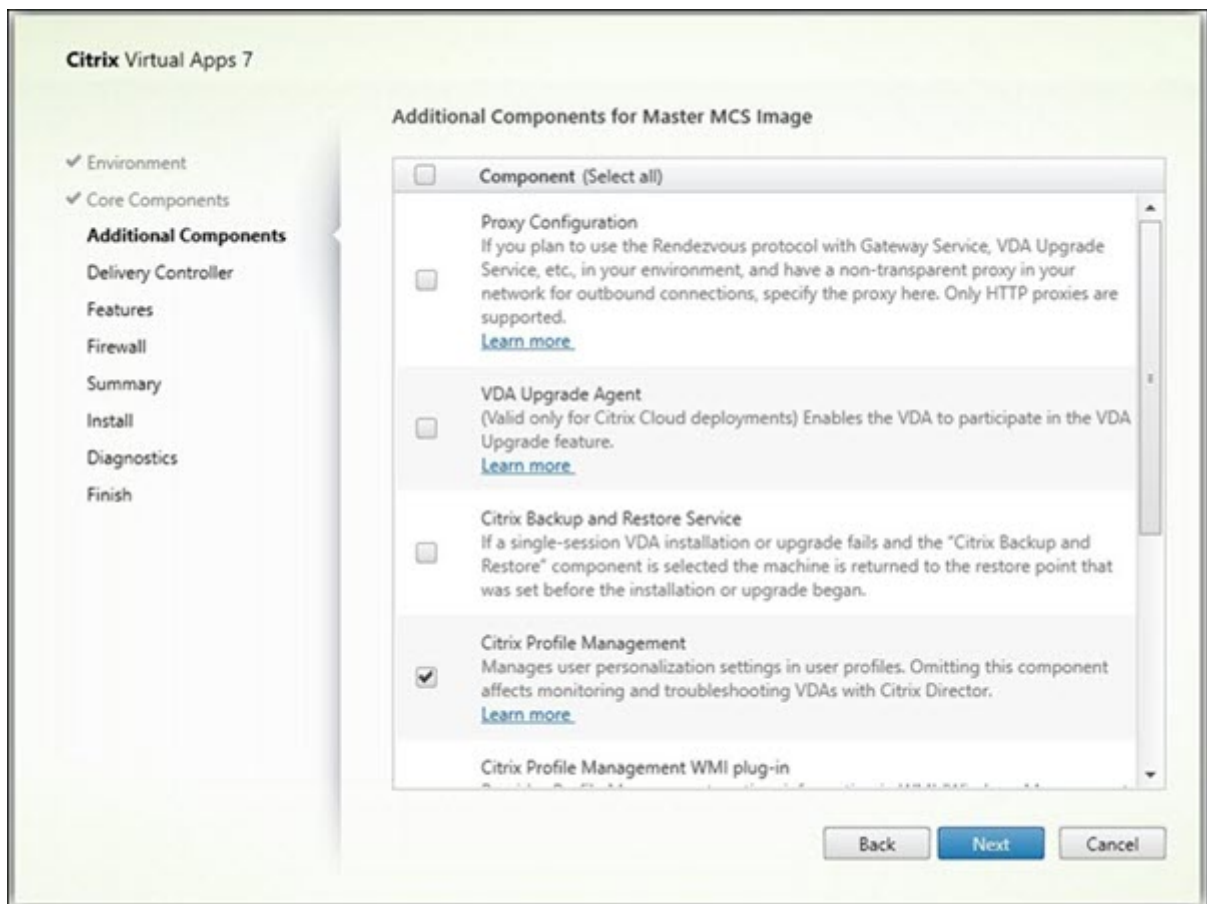

The **Additional Components** page contains check boxes to enable or disable installation of other features and technologies with the VDA. In a command-line installation, you can use the `/exclude` or `/includeadditional` option to expressly omit or include one or more available components.

The following table indicates the default setting of items on this page. The default setting depends on the option that you selected on the **Environment** page.

Additional Components page	Environment page: “Master image with MCS” or “Master image with Citrix Provisioning” selected	Environment page: “Enable brokered connections to server”(for multi-session OS) or “Remote PC Access”(for single-session OS) selected
Citrix Personalization for App-V - VDA	Not selected	Not selected
User Personalization Layer	Not selected	Not shown because it’s not valid for this use case.
Citrix Profile Management	Selected	Not selected
Citrix Profile Management WMI Plug-in	Selected	Not selected
Citrix VDA Upgrade Agent	Not selected	Not selected
Citrix Backup and Restore	Not selected	Not selected
Citrix MCS IODriver	Not selected	Not selected
Citrix Rendezvous V2	Not selected	Not selected

This page does not appear if:

- You are using the `VDAWorkstationCoreSetup.exe` installer. Also, the command-line options for the additional components are not valid with that installer.
- You are upgrading a VDA and all the additional components are already installed. If some of the additional components are already installed, the page lists only components that are not installed.

Select or clear the following check boxes. (The components might appear in a different order in the installer.)

- **Citrix Personalization for App-V:** Install this component if you use applications from Microsoft App-V packages. For details, see [Deploy and deliver App-V applications](#).

Command-line option: `/includeadditional "Citrix Personalization for App-V – VDA"` to enable component installation, `/exclude "Citrix Personalization for App-V – VDA"` to prevent component installation.

- **Citrix User Personalization Layer:** Installs the MSI for the user personalization layer. For details, see [User personalization layer](#).

This component appears only when installing a VDA on a single-session Windows 10 machine.

Command-line option: `/includeadditional "User Personalization Layer"`

to enable component installation, `/include "User Personalization Layer"` to prevent component installation.

- **Citrix Profile Management:** This component manages user personalization settings in user profiles. For details, see [Profile Management](#).

Excluding Citrix Profile Management from the installation affects the monitoring and troubleshooting of VDAs with Citrix Director. On the **User details** and **End Point** pages, the **Personalization** panel and the **Logon Duration** panel fail. On the **Dashboard** and **Trends** pages, the **Average Logon Duration** panel display data only for machines that have Profile Management installed.

Even if you are using a third-party user profile management solution, Citrix recommends that you install and run the Citrix Profile Management Service. Enabling the Citrix Profile Management Service is not required.

Command-line option: `/includeadditional "Citrix Profile Management"` to enable component installation, `/exclude "Citrix Profile Management"` to prevent component installation.

- **Citrix Profile Management WMI Plug-in:** This plug-in provides Profile Management runtime information in WMI (Windows Management Instrumentation) objects (for example, profile provider, profile type, size, and disk usage). WMI objects provide session information to Director.

Command-line option: `/includeadditional "Citrix Profile Management WMI Plug-in"` to enable component installation, `/exclude "Citrix Profile Management WMI Plug-in"` to prevent component installation.

- **VDA Upgrade Agent:** Applicable only to Citrix DaaS (formerly Citrix Virtual Apps and Desktops service) deployments. Enables the VDA to participate in the [VDA Upgrade feature](#). You can use that feature to upgrade a catalog's VDAs from the management console, immediately or at a scheduled time. If this agent is not installed, you can upgrade a VDA by running the VDA installer on the machine.

Command-line options: `/includeadditional "Citrix VDA Upgrade Agent"` to enable component installation, `/exclude "Citrix VDA Upgrade Agent"` to prevent component installation.

- **MCSIO write cache for storage optimization:** Installs the Citrix MCS I/O driver. For more information, see [Storage shared by hypervisors](#) and [Configure cache for temporary data](#).

Command-line options: `/includeadditional "Citrix MCS IODriver"` to enable component installation, `/exclude "Citrix MCS IODriver"` to prevent component installation.

- **Proxy Configuration:** Install this component if you plan to use the Rendezvous protocol with the Gateway Service, VDA Upgrade Service, and so on, in your environment, and you have a non-transparent proxy in your network for outbound connections, specify the proxy here. Only HTTP proxies are supported.

If you install this component, specify the address of the proxy or PAC file path on the **Rendezvous Proxy Configuration** page. For feature details, see [Rendezvous protocol](#).

Command-line option: `/includeadditional "Citrix Rendezvous V2"` to enable component installation, `/exclude "Citrix Rendezvous V2"` to prevent component installation.

- **Citrix Backup and Restore:** If a VDA installation or upgrade fails, then this component can return the machine to a backup that was done before the installation or upgrade.

Make sure that the Microsoft prerequisites are met as mentioned in [Prepare to install](#).

Command-line option: `/includeadditional "Citrix Backup and Restore"` to enable component installation, `/exclude "Citrix Backup and Restore"` to prevent component installation.

Note:

If the MCS storage optimization is enabled, then the backup or restore for Windows server or desktop Operating System can fail. To resolve this, disable the MCS storage optimization option in the meta installer.

Step 7. Delivery Controller addresses

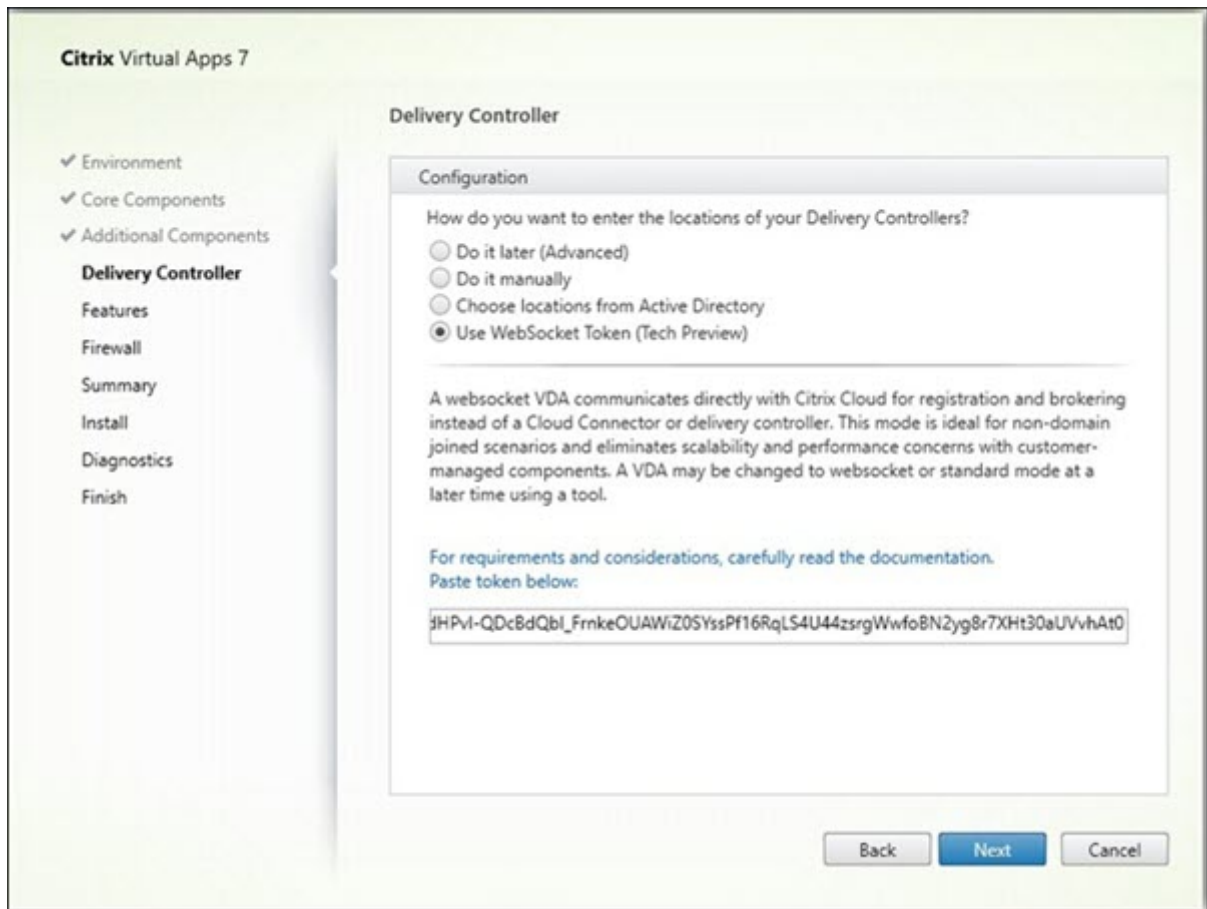

On the **Delivery Controller** page, choose how you want to enter the addresses of installed Controllers. Citrix recommends that you specify the addresses while you're installing the VDA (**Do it manually**). The VDA cannot register with a Controller until it has this information. If a VDA cannot register, users cannot access applications and desktops on that VDA.

- **Do it manually:** (default) Enter the FQDN of an installed Controller and then click **Add**. If you've installed more Controllers, add their addresses.
- **Do it later (Advanced):** If you choose this option, the wizard asks you to confirm that's what you want to do before continuing. To specify addresses later, you can either rerun the installer or use Citrix Group Policy. The wizard also reminds you on the **Summary** page.
- **Choose locations from Active Directory:** Valid only when the machine is joined to a domain and the user is a domain user.
- **Let Machine Creation Services do it automatically:** Valid only when using MCS to provision machines.

Click **Next**. If you selected **Do it later (Advanced)**, you are prompted to confirm that you will specify Controller addresses later.

Other considerations:

- The address cannot contain non-alphanumeric characters.
- If you specify addresses during VDA installation and in Group Policy, the policy settings override settings provided during installation.
- Successful VDA registration requires that the firewall ports used to communicate with the Controller are open. That action is enabled by default on the **Firewall** page of the wizard.
- After you specify Controller locations (during or after VDA installation), you can use the auto-update feature to update the VDAs when Controllers are added or removed. For details about how VDAs discover and register with Controllers, see [VDA registration](#).

Command-line option: `/controllers`

Step 8. Proxy Configuration

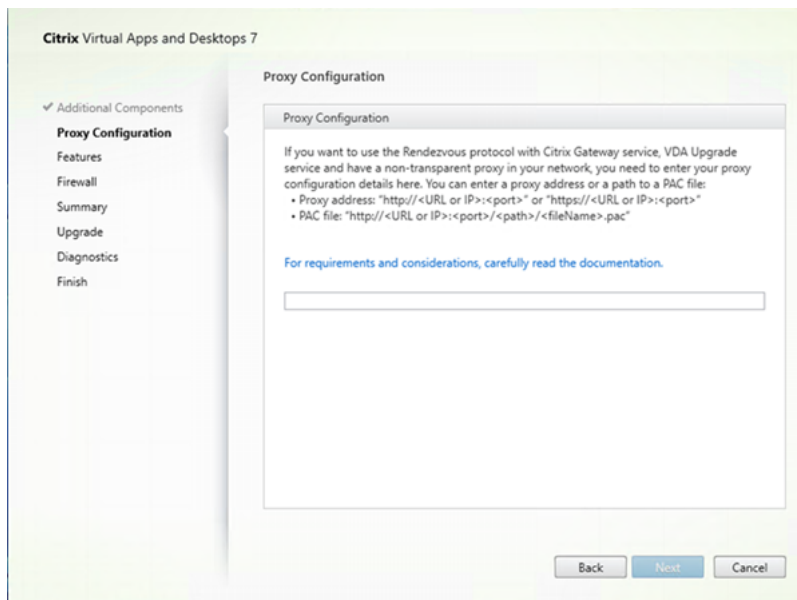

The **Proxy Configuration** page appears only if you enabled the **Proxy Configuration** check box on the **Additional Components** page.

1. Select whether you will specify the proxy source by proxy address or PAC file path.
2. Specify the proxy address or PAC file path.
 - Proxy address format: `http://<url-or-ip>:<port>`
 - PAC file format: `http://<url-or-ip>:<port>/<path>/<filename>.pac`

The firewall for the proxy port must be open for the connection test to succeed. If a connection cannot be made to the proxy, you can choose whether to continue with the VDA installation.

Command-line option: `/proxyconfig`

Step 9. Enable or disable features

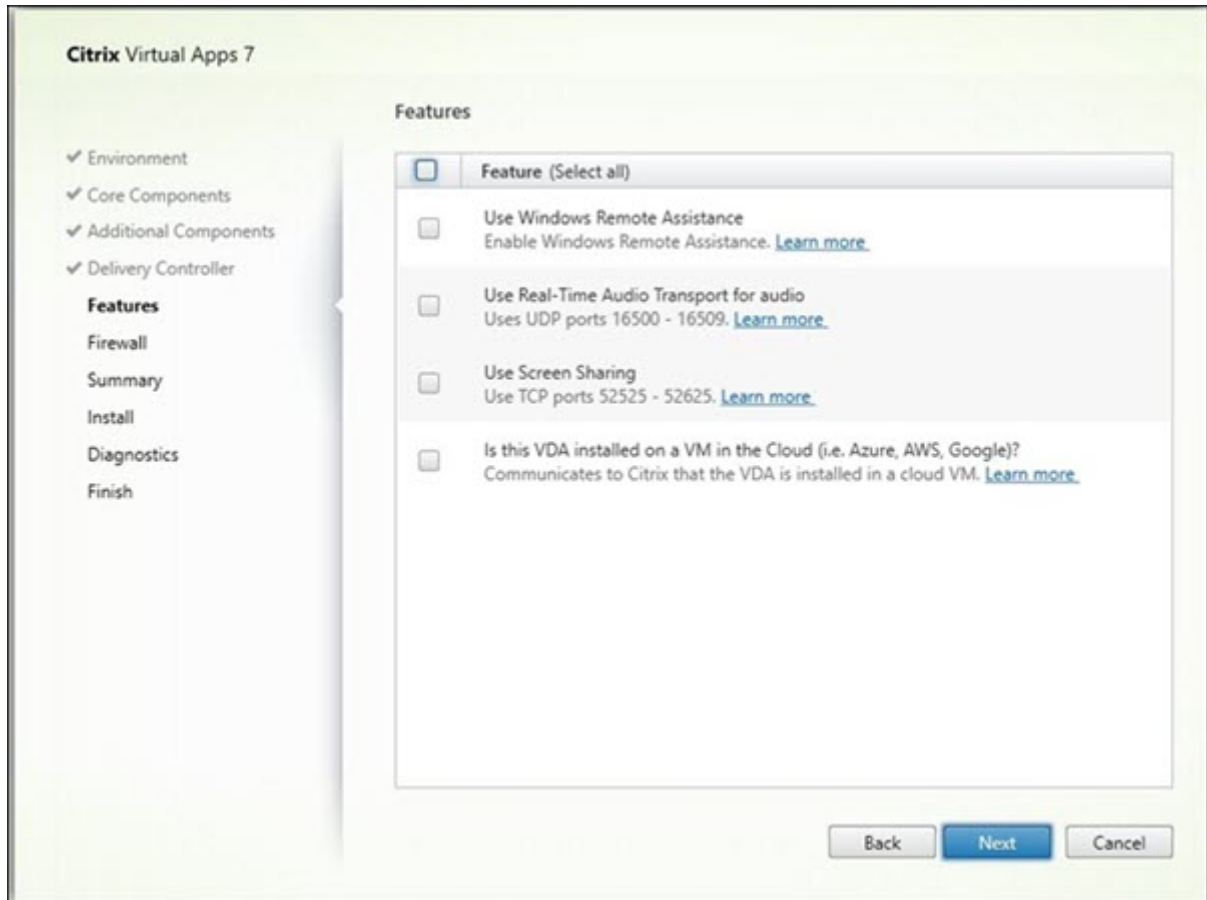

On the **Features** page, use the check boxes to enable or disable the features you want to use.

- **Use Windows Remote Assistance:** When this feature is enabled, Windows Remote Assistance is used with the user shadowing feature of Director. Windows Remote Assistance opens the dynamic ports in the firewall. (Default = disabled)

Command-line option: `/enable_remote_assistance`

- **Use Real-Time Audio Transport for audio:** Enable this feature if voice-over-IP is widely used in your network. The feature reduces latency and improves audio resilience over lossy networks. It allows audio data to be transmitted using RTP over UDP transport. (Default = disabled)

Command-line option: `/enable_real_time_transport`

- **Use screen sharing:** When enabled, ports used by screen sharing are opened in the Windows firewall. (Default = disabled)

Command-line option: `/enable_ss_ports`

- **Is this VDA installed on a VM in a cloud:** This setting helps Citrix to correctly identify resource locations for on-premises and service (Citrix Cloud) VDA deployments for telemetry purposes.

This feature has no impact on customer-side utilization. Enable this setting if your deployment uses Citrix DaaS (Default = disabled).

Command-line option: `/xendesktopcloud`

Click **Next**.

Step 10. Firewall ports

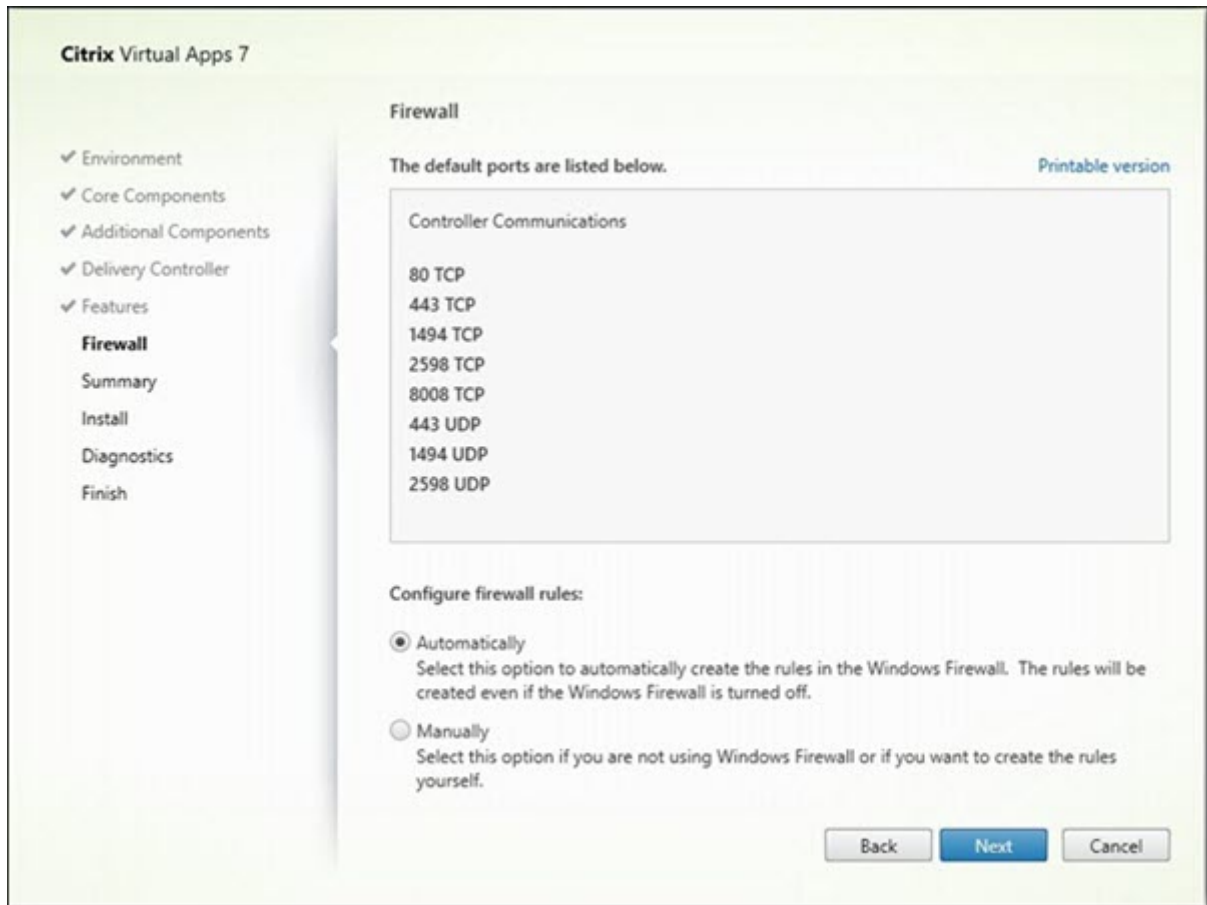

On the **Firewall** page, by default, the ports are opened automatically if the Windows Firewall Service is running, even if the firewall is not enabled. This default setting is fine for most deployments. For port information, see [Network ports](#).

Click **Next**.

Command-line option: `/enable_hdx_ports`

Step 11. Review prerequisites and confirm installation

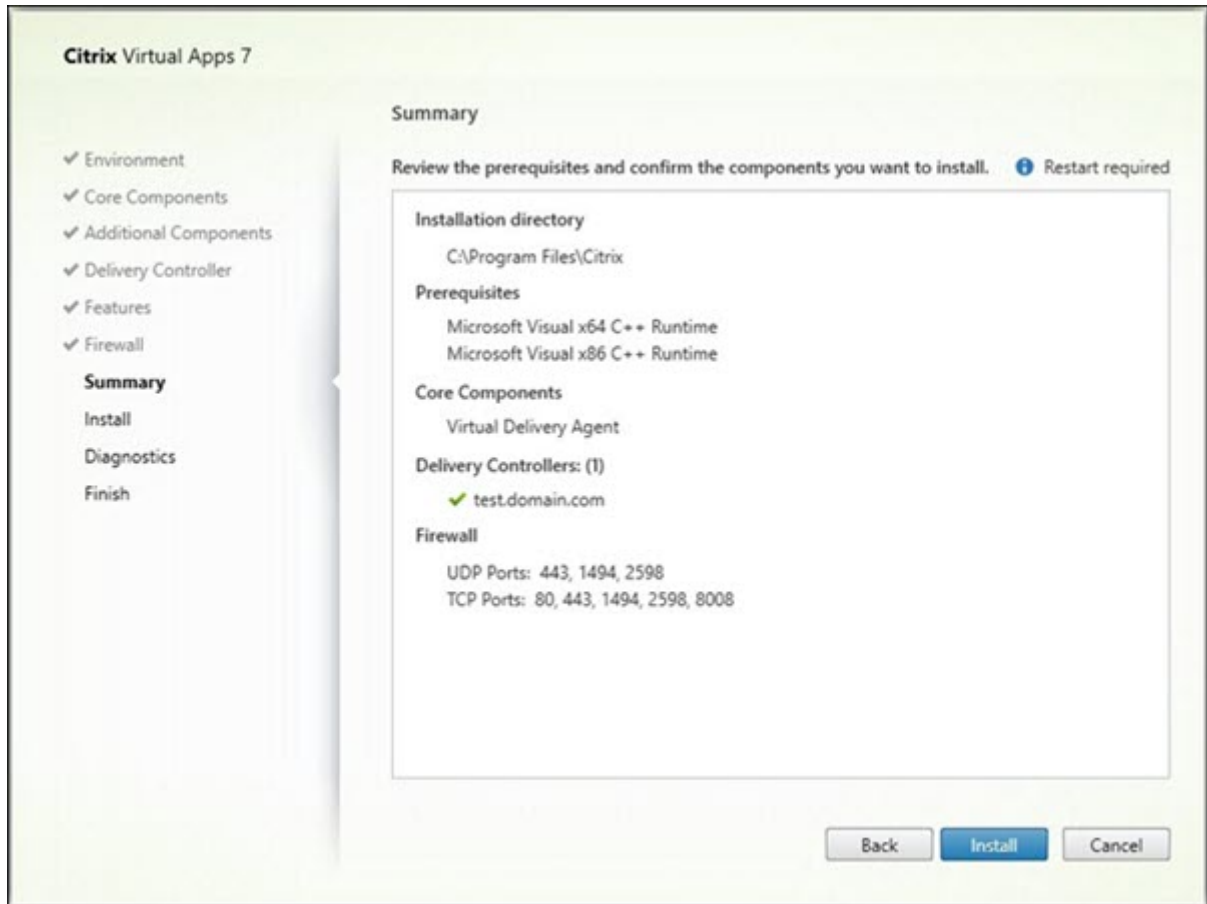

The **Summary** page lists what will be installed. Use the **Back** button to return to earlier wizard pages and change selections.

When you're ready, click **Install**.

If prerequisites aren't already installed or enabled, the machine might restart once or more times. See [Prepare to install](#).

Step 12. Diagnostics

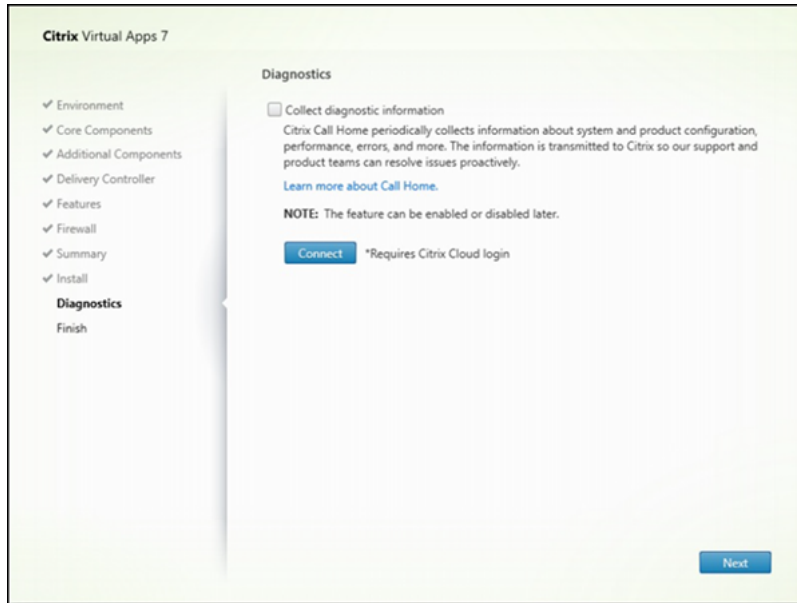

On the **Diagnostics** page, choose whether to participate in Citrix Call Home. If you choose to participate (the default), click **Connect**. When prompted, enter your Citrix account credentials.

After your credentials are validated (or if you choose not to participate), click **Next**.

When using the full product installer, if you click **Connect** on the **Diagnostics** page without first selecting **Collect diagnostic information**, after you close the **Connect to Citrix Insight Services** dialog the **Next** button is disabled. You cannot move to the next page. To reenble the **Next** button, select and immediately deselect **Collect diagnostic information**.

For more information, see [Call Home](#).

Step 13. Complete this installation

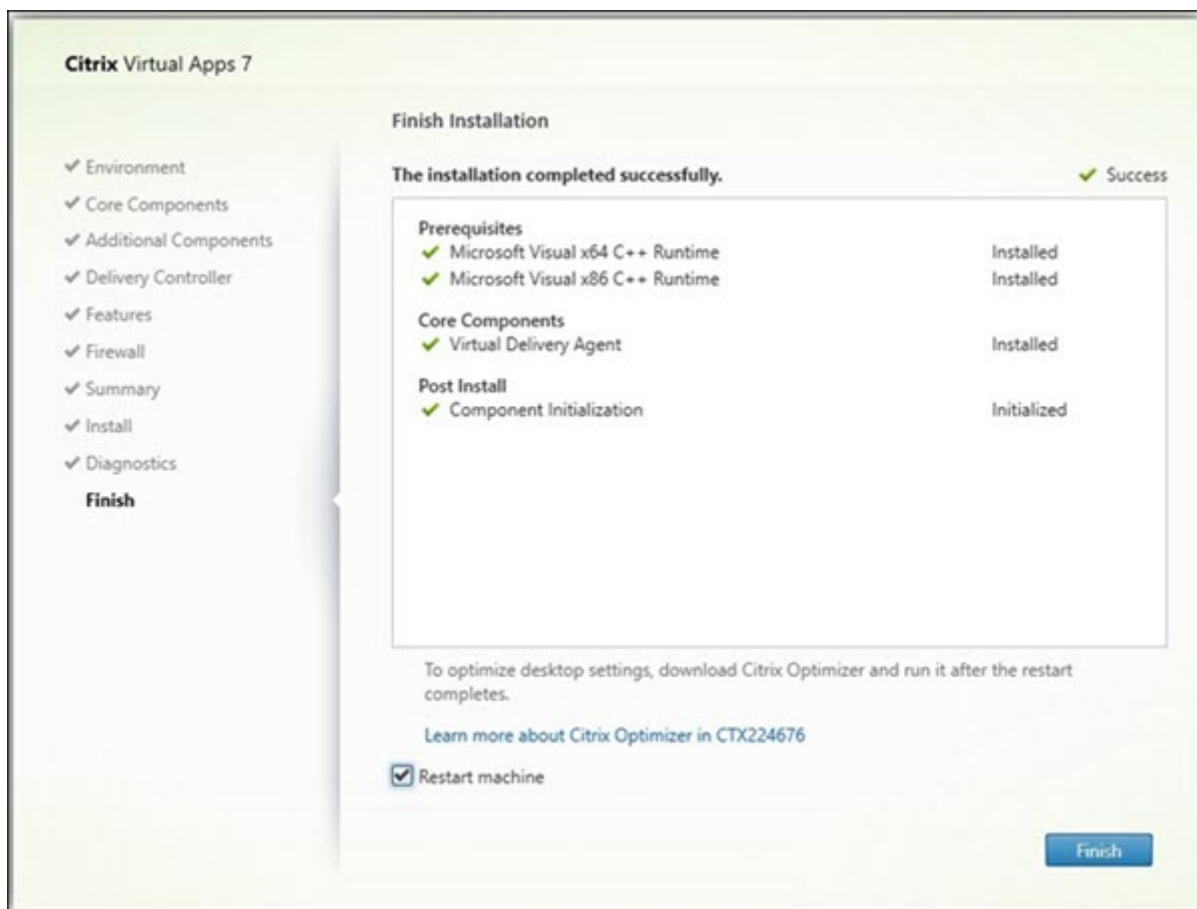

The **Finish** page contains green check marks for all prerequisites and components that installed and initialized successfully.

Click **Finish**. By default, the machine restarts automatically. Although you can disable this automatic restart, the VDA cannot be used until the machine restarts.

Next steps

Repeat the procedure above to install VDAs on other machines or images, if needed.

After you install all VDAs, launch Studio. If you haven't created a site yet, Studio automatically guides you to that task. After that's done, Studio guides you to create a machine catalog and then a delivery group. See:

- [Create a site](#)
- [Create machine catalogs](#)
- [Create delivery groups](#)

Citrix Optimizer

Citrix Optimizer is a tool for Windows OS that helps Citrix administrators optimize VDAs by removing and optimizing various components.

After installing a VDA and completing the final restart, download and install Citrix Optimizer. See [CTX224676](#). The CTX article contains the download package, plus instructions about installing and using Citrix Optimizer.

Customize a VDA

To customize an installed VDA:

1. From the Windows feature for removing or changing programs, select **Citrix Virtual Delivery Agent** or **Citrix Remote PC Access/VDI Core Services VDA**. Then right-click and select **Change**.
2. Select **Customize Virtual Delivery Agent Settings**. When the installer launches, you can change:
 - Controller addresses
 - TCP/IP port to register with the Controller (default = 80)
 - Whether to open Windows Firewall ports automatically

Troubleshoot

- For information about how Citrix reports the results of component installations, see [Citrix installation return codes](#).
- In the Studio display for a delivery group, the **Installed VDA version** entry in the **Details** pane might not be the version installed on the machines. The machine's Windows Programs and Features display shows the actual VDA version.
- After a VDA is installed, it cannot deliver apps or a desktop to users until it registers with a Delivery Controller.

To learn about VDA registration methods and how to troubleshoot registration issues, see [VDA registration](#).

Known limitation

When you use Citrix Workspace app for Windows version 1912 or earlier, the session drops after a while. This issue is fixed in the newer LTSR and CR versions of Citrix Workspace app.

For more information on the supported release versions, see [Citrix Workspace app for Windows / Citrix Receiver for Windows Long Term Service Releases](#).

Configure Windows Defender Access Control related to VDA Installation

March 29, 2024

Customers configure Windows Defender Access Control (WDAC) settings to prohibit loading of unsigned binaries. The unsigned binaries distributed through VDA installers are thus prohibited which restricts the VDA installation.

Citrix now signs all Citrix-generated binaries with a Citrix code signing certificate. Additionally, Citrix also signs the third-party binaries which are distributed along with our product with a certificate that authenticates those third-party binaries as trusted binaries.

Important:

Upgrading from an older VDA with unsigned third-party binaries to a newer VDA version with signed binaries may not always place the signed binaries on the upgraded machine.

This is due to a mechanism within the OS where upgrade of the system does not replace binaries with the same version.

Although the third-party binaries have been signed, their versions, which are controlled by third parties, are not able to be updated by Citrix, resulting in these binaries not being updated. To avoid this limitation:

1. Include the binaries in an allow list. This eliminates the need for signing the binaries.
2. Uninstall the older VDA and install the new VDA. This resembles a fresh VDA install and the signed versions will be installed.

Create a new Base Policy with the Wizard

The WDAC allows you to add trusted binaries to run on your system. After the installation of WDAC, the **Windows Defender Application Control Policy Wizard** opens automatically.

To add the binaries, a new base WDAC policy must be created. Citrix-recommended guidelines for creating a base policy are provided in this section.

- Select **Signed and Reputable Mode** as the base template because it authorizes Windows operating components, apps installed from the Microsoft Store, all Microsoft-signed software, and third-party Windows hardware-compatible drivers.
- **Enable Audit Mode** because it allows you to test new Windows Defender Application Control policies before you enforce them.
- Add **Custom Rule** for **File Rules** to specify the level at which applications are identified and trusted and provide a reference file. By selecting “Publisher” as the rule type, a reference file that is signed by one of the Citrix certificates can be selected.

- After the rules are added, navigate to the folder where **.XML** and **.CIP** files are saved. The **.XML** file has all the rules defined in the policy. It can be configured to change, add, or remove any rules.
- Before deploying the WDAC policies, the **.XML** file must be converted to its binary form. The WDAC file converts the **.XML** file to **.CIP** file.
- Copy and paste the **.CIP** file to: **C:\WINDOWS\System32\CodeIntegrity\CiPolicies\Active** and reboot the machine. The generated policy will be applied in audit mode.
- For a step-by-step process to create a base policy, see [Creating a new Base Policy with the Wizard](#).

When this policy is applied, WDAC does not give warnings about any Citrix files that are signed by the specified publisher/CA authority.

Similarly, we can create a publisher-level rule for the files that have been signed by the third party.

Verify the applied policy

1. After the machine has been rebooted, open the **Event Viewer** and go to **Applications and Services Logs > Microsoft > Windows > CodeIntegrity > Operational**.
2. Make sure the applied policy is activated.

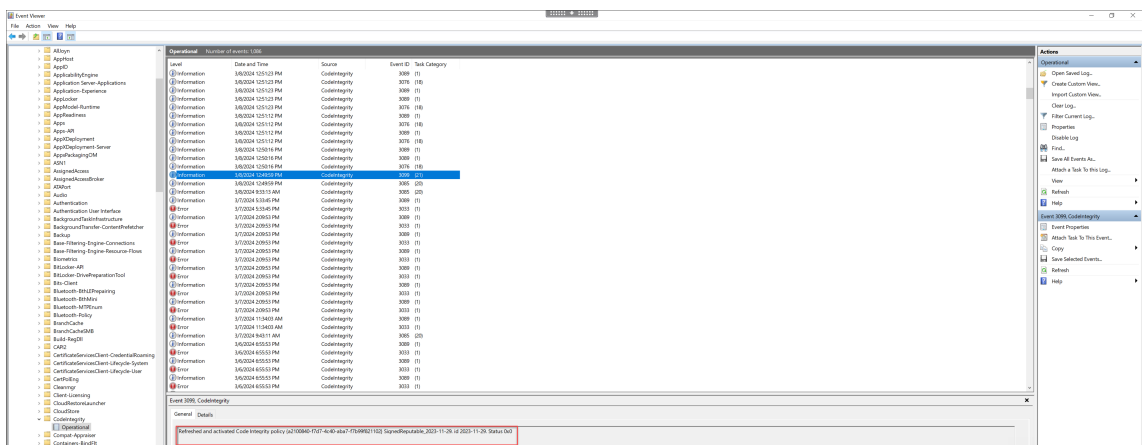

3. Look for logs that have violated the policy and check the properties of that file. First, confirm it has been signed. If not and this machine has gone through a VDA upgrade, this most likely is the case described in the limitation above. If signed, this file is potentially signed with the alternate certificate, as described previously.

An example of a Citrix-generated file signed with a Citrix certificate is **C:\Windows\System32\drivers\picadm.sys**.

An example of a third-party binary signed with the Citrix third-party certificate is **C:\Program Files\Citrix\IcaConfigTool\Microsoft.Practices.Unity.dll**.

Install VDAs using scripts

February 12, 2024

Note:

Citrix is not responsible for issues caused by scripts that are adapted to match customer production environments. For any install related Citrix issues, open a technical support case with the relevant install logs using the [Citrix Support portal](#).

This article applies to installing VDAs on machines with Windows operating systems. For information about VDAs for Linux operating systems, see the [Linux Virtual Delivery Agent](#) documentation.

The installation media contains sample scripts that install, upgrade, or remove Virtual Delivery Agents (VDAs) for machines in Active Directory. You can also use the scripts to maintain master images used by Machine Creation Services and Citrix Provisioning (formerly Provisioning Services).

Required access:

- The scripts need Everyone Read access to the network share where the VDA installation command is located. The installation command is `XenDesktopVdaSetup.exe` in the full product ISO, or `VDAWorkstationSetup.exe` or `VDA ServerSetup.exe` in a standalone installer.
- Logging details are stored on each local machine. To log results centrally for review and analysis, the scripts need Everyone Read and Write access to the appropriate network share.

To check the results of running a script, examine the central log share. Captured logs include the script log, the installer log, and the MSI installation logs. Each installation or removal attempt is recorded in a time-stamped folder. The folder title indicates the operation result with the prefix PASS or FAIL. You can use standard directory search tools to find a failed installation or removal in the central log share. Those tools offer an alternative to searching locally on the target machines.

Before beginning any installation, read and complete the tasks in [Prepare to install](#).

Install or upgrade VDAs using the script

1. Obtain the sample script **InstallVDA.bat** from `\Support\AdDeploy\` on the installation media. Citrix recommends that you make a backup of the original script before customizing it.
2. Edit the script:
 - Specify the version of the VDA to install: `SET DESIREDVERSION`. The full value can be found on the installation media in the `ProductVersion.txt` file. However, a complete match is not required.

- Specify the network share where the installer will be invoked. Point to the root of the layout (the highest point of the tree). The appropriate version of the installer (32-bit or 64-bit) is called automatically when the script runs. For example: `SET DEPLOYSHARE=\\fileserv1\share1`.
 - Optionally, specify a network share location for storing centralized logs. For example: `SET LOGSHARE=\\fileserv1\log1`.
 - Specify VDA configuration options as described in [Install using the command line](#). The `/quiet` and `/noreboot` options are included by default in the script and are required: `SET COMMANDLINEOPTIONS=/QUIET /NOREBOOT`.
3. Using Group Policy Startup Scripts, assign the script to the OU containing your machines. This OU should contain only machines on which you want to install the VDA. When the machines in that OU are restarted, the script runs on all of them. A VDA is installed on each machine that has a supported operating system.

Remove VDAs using the script

1. Obtain the sample script `UninstallVDA.bat` from `\Support\AdDeploy\` on the installation media. Citrix recommends that you make a backup of the original script before customizing it.
2. Edit the script.
 - Specify the version of the VDA to remove: `SET CHECK_VDA_VERSION`. The full value can be found on the installation media in the `ProductVersion.txt` file (such as 7.0.0.3018). However, a complete match is not required.
 - Optionally, specify a network share location for storing centralized logs.
3. Using Group Policy Startup Scripts, assign the script to the OU containing your machines. This OU should contain only machines from which you want to remove the VDA. When the machines in the OU are restarted, the script runs on all of them. The VDA is removed from each machine.

Troubleshoot

- The script generates internal log files that describe script execution progress. The script copies a `Kickoff_VDA_Startup_Script` log to the central log share within seconds of starting the deployment. You can verify that the overall process is working. If this log is not copied to the central log share as expected, troubleshoot further by inspecting the local machine. The script places two debugging log files in the `%temp%` folder on each machine:

- `Kickoff_VDA_Startup_Script_<DateTimeStamp>.log`
- `VDA_Install_ProcessLog_<DateTimeStamp>.log`

Review these logs to ensure that the script is:

- Running as expected.
 - Properly detecting the target operating system.
 - Correctly configured to point to the **ROOT** of the **DEPLOYSHARE** share (contains the file named **AutoSelect.exe**).
 - Capable of authenticating to both the **DEPLOYSHARE** and **LOG** shares.
- For information about how Citrix reports the result of component installations, see [Citrix installation return codes](#).
 - In the Studio display for a delivery group, the **Installed VDA version** entry in the **Details** pane might not be the version installed on the machines. The machine's programs and features display shows the actual VDA version.
 - After a VDA is installed, it cannot deliver apps or a desktop to users until it registers with a Delivery Controller.

To learn about VDA registration methods and how to troubleshoot registration issues, see [VDA registration](#).

Install VDAs using SCCM

November 15, 2023

Note:

Citrix is not responsible for issues that arise caused by the deployment of a Virtual Delivery Agent (VDA) using software distribution tools such as Microsoft System Center Configuration Manager (SCCM) adapted to match customer production environments. For any install related Citrix issues, open a technical support case with the relevant install logs using the [Citrix Support portal](#).

Overview

To successfully deploy a Virtual Delivery Agent (VDA) using Microsoft System Center Configuration Manager (SCCM) or similar software distribution tools, Citrix recommends using the VDA installer in a sequence of steps.

Citrix does not recommend using the VDA Cleanup Utility as part of a VDA installation or upgrade. Use the VDA Cleanup Utility only in the limited case when the VDA installer has previously failed.

Restarts

The required number of restarts during the installation of the VDA depends on the environment. For example:

- A restart might be required for pending updates or restarts from earlier software installations.
- Files previously locked by other processes might need updates, forcing an extra restart.
- Some optional components in the VDA installer (such as Citrix Profile Management and Citrix Files) might require a restart.

The SCCM Task Sequencer manages all required restarts.

Define the task sequence

After identifying all prerequisites and restarts, use the SCCM Task Sequencer to complete the following:

- The VDA can be installed from an accessible copy of the installation media or from one of the VDA standalone installers:
 - `VDAWorkstationSetup_XXXX.exe`
 - `VDA ServerSetup_XXXX.exe`
 - `VDAWorkstationCoreSetup_XXXX.exe`

For more information about VDA installers, see [Installers](#).

- When upgrading a VDA, the machine on which it is installed must be in maintenance mode, with no sessions.
- When a VDA installation runs for the first time on a machine, the VDA installer being used is copied onto that machine.
 - When using a VDA installer other than `VDAWorkstationCoreSetup_XXXX.exe`, the VDA installer is copied to `%ProgramData%\Citrix\XenDesktopSetup\XenDesktopVdaSetup.exe`.
 - When using `VDAWorkstationCoreSetup_XXXX.exe`, the VDA installer is copied to `%ProgramData%\Citrix\XenDesktopSetup\XenDesktopRemotePCSetup.exe`.
- The directory location of the VDA installer is also stored in the registry “`HKEY_LOCAL_MACHINE\SOFTWARE\Citrix\MetaInstall`” “`MetaInstallerInstallLocation`”.
- Add the command line options `/NOREBOOT`, `/NORESUME`, and `/QUIET` to your command line options.

- /QUIET: Do not show the user interface during installation, so that SCCM has control of the installation process.
- /NOREBOOT: Suppress the VDA installer from restarting automatically. SCCM triggers restarts when needed.
- /NORESUME: Usually, when a restart is needed during the installation, the VDA installer sets a `runonce` registry key (`\HKEY_LOCAL_MACHINE\SOFTWARE\Microsoft\Windows\CurrentVersion\RunOnce`). When the machine restarts, Windows uses the key to launch the VDA installer. This is an issue for SCCM, because SCCM cannot monitor the installation and capture the exit code.

Example installation sequence using SCCM

The following example shows the installation sequence.

1. **Restart Computer:** Prepare the machine by restarting the machine.

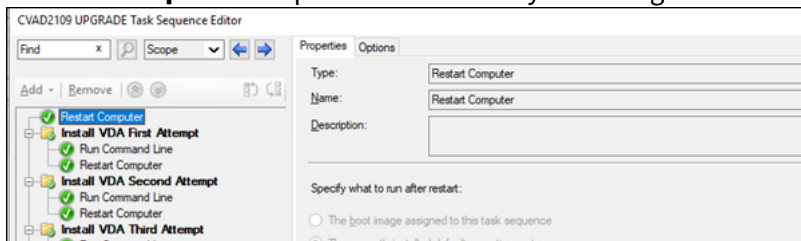

2. **Install VDA First Attempt:** Start the VDA installation.

- a) Add the `/quiet`, `/noreboot`, and `/noresume` options to your command line options.
- b) Run the VDA installer of your choice (local image or one of the minimal installers).

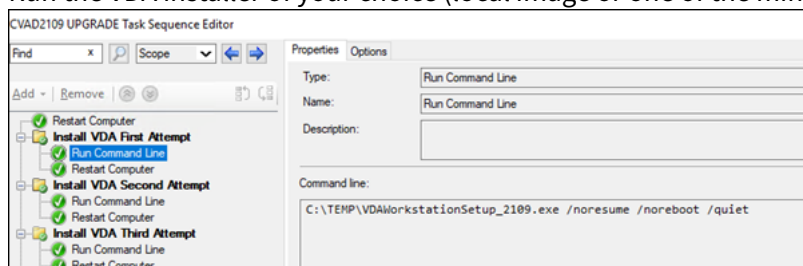

- c) SCCM must capture the return code.

- If the return code is 0 or 8, the installation is complete, and a restart is needed.

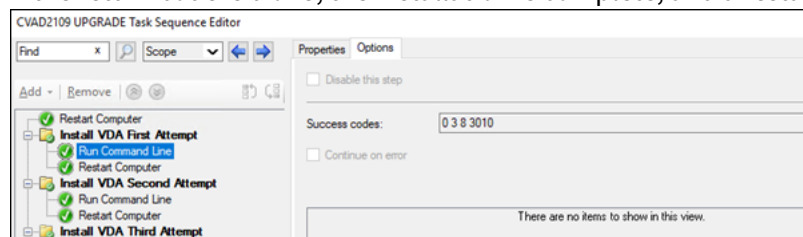

- If a return code is 3, restart the machine and then pass control to **Install VDA Second Attempt**.

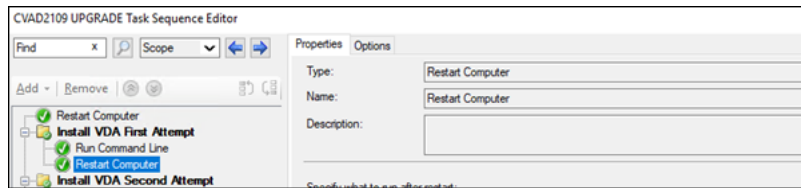

3. **Install VDA Second Attempt:** Continue VDA installation.

- a) After **Install VDA First Attempt** if the file `%programdata%\Citrix\XenDesktopSetup\CitrixVirtualDesktopAgent.xml` exists, the installation is not complete and must be continued after the restart completes.

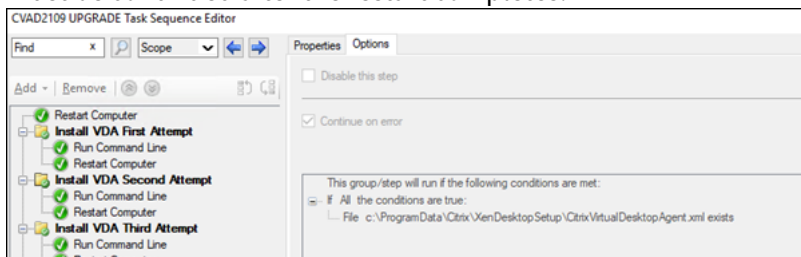

- b) **Install VDA Second Attempt** repeats until the file `%programdata%\Citrix\XenDesktopSetup\CitrixVirtualDesktopAgent.xml` does not exist or a return code other than 0 or 8 is returned. Treat any other return code as an error, and **INSTALL VDA SECOND ATTEMPT** should report an error and stop.
- c) Resume the VDA installation by running the appropriate VDA installer (`XenDesktopVdaSetup.exe` for most cases, or `XenDesktopRemotePCSetup.exe` if `VDAWorkstationCoreSetup_XX.exe` was used) from the file `%programdata%\Citrix\XenDesktopSetup\` directory with no command-line parameters. (The VDA installer uses the parameters it saved during the first run of the installer.)

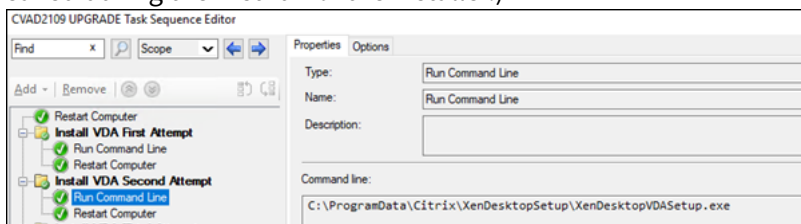

- d) Watch for the return code from the VDA installer.
- 0 or 8: Success, installation complete, restart required.

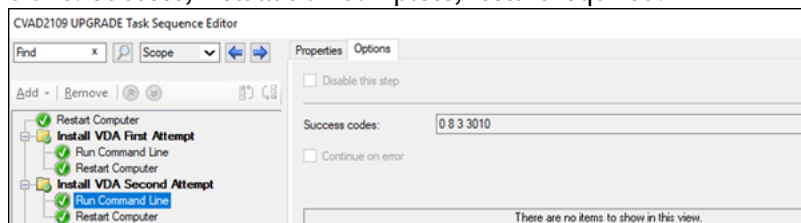

- 3: Installation is not complete. Restart the machine and repeat **INSTALL VDA SECOND ATTEMPT** until the file `%programdata%\Citrix\XenDesktopSetup\CitrixVirtualDesktopAgent.xml` does not exist or until a 0 or 8 is returned.

Treat any other return code as an error, and INSTALL VDA SECOND ATTEMPT should report an error and end.

For more information about return codes see [Citrix installation return codes](#).

VDA installation command examples

The available installation options vary, depending on which installer is used. See the following articles for command line option details.

- [Install VDAs](#)
- [Install using the command line](#)

Installation commands for Remote PC Access

- The following command uses the single-session core VDA installer (VDAWorkstationCoreSetup.exe):

```
VDAWorkstationCoreSetup.exe /quiet /controllers "control.domain.com" /enable_hdx_ports /noresume /noreboot
```

- The following command uses the single-session full VDA installer (VDAWorkstationSetup.exe):

```
VDAWorkstationSetup.exe /quiet /remotepc /physicalmachine /controllers "control.domain.com" /enable_hdx_ports /noresume /noreboot
```

Installation command for dedicated VDI

- The following command uses the single-session full VDA installer (VDAWorkstationSetup.exe):

```
VDAWorkstationSetup.exe /quiet /components vda /controllers "control.domain.com" /enable_hdx_ports /enable_remote_assistance /noresume /noreboot
```

Create a site

November 13, 2023

Note:

During site creation, after you add a license to enable Hybrid Rights License, public cloud hosts (such as Microsoft Azure, Google Cloud Platform, and Amazon Web Services) do not appear in the connection type list until the site creation completes.

A site is the name you give to a Citrix Virtual Apps and Desktops deployment. It comprises the Delivery Controllers and other core components, Virtual Delivery Agents (VDAs), connections to hosts, machine catalogs, and delivery groups. You create the site after you install the core components and before creating the first machine catalog and delivery group.

If your Controller is installed on Server Core, use PowerShell cmdlets in the [Citrix Virtual Apps and Desktops SDK](#) to create a site.

When you create a site, you are automatically enrolled in the Citrix Customer Experience Improvement Program (CEIP). CEIP collects anonymous statistics and usage information, and then sends it to Citrix. The first data package is sent to Citrix approximately seven days after you create the site. You can change your enrollment at any time after site creation. Select **Settings** in the Web Studio left pane, and then locate the **Citrix Customer Experience Improvement Program** setting. For details, see <http://more.citrix.com/XD-CEIP>.

The user who creates a site becomes a full administrator. For more information, see [Delegated administration](#).

Review this article before you create the site, so you know what to expect.

Step 1. Open the site creation wizard - Citrix Site Manager

Use the tool, Citrix Site Manager, to set up your Citrix Virtual Apps and Desktops deployment (also known as a site). The tool is installed automatically when you install a Delivery Controller.

To run this tool, open your desktop Start menu on a Delivery Controller, and select **Citrix > Citrix Site Manager**. See [Install Web Studio](#).

Step 2. Site name

On the **Introduction** page, type a name for the site.

Step 3. Databases

The **Databases** page contains selections for setting up the site, monitoring, and configuration logging databases. For details about database setup choices and requirements, see [Databases](#).

Note:

If an SQL Server Always On Listener is configured for TLS encryption, you might be prompted to enter credentials with database creation permissions. Attempts to create the database still fail even if you enter valid administrator credentials. Verify that the SQL Server certificate includes the listener DNS name in the Subject Alternative Names (SAN). For more information, see <https://docs.microsoft.com/en-us/sql/database-engine/availability-groups/windows/listeners-client-connectivity-application-failover#SSLCertificates>.

If you choose to install SQL Server Express for use as the site database (the default), a restart occurs after that software is installed. That restart does not occur if you choose not to install the SQL Server Express software for use as the site database.

If you are not using the default SQL Server Express, ensure that the SQL Server software is installed on the machines before creating a site. [System requirements](#) lists the supported versions.

If you want to add more Delivery Controllers to the site, and have already installed the Controller software on other servers, you can add those Controllers from this page. If you also plan to generate scripts that set up the databases, add the Controllers before generating the scripts.

Step 4. Licensing

On the **Licensing** page, specify the License Server address and then indicate which license to use (install).

- Specify the License Server address in the form `name: [port]`. The *name* must be an FQDN, NetBIOS, or IP address. FQDN is recommended. If you omit the port number, the default is 27000. Click **Connect**. You cannot proceed to the next page until a successful connection is made to the License Server.
- When a connection is made, **Use an existing license** is selected by default. The display lists the compatible products that this product can be configured as, based on currently installed licenses.
 - If you want to configure this product as one of the listed products (for example, Citrix Virtual Apps Premium or Citrix Virtual Desktops Premium), using one of those licenses, select that entry.
 - If you already allocated and downloaded a license (using the Citrix Manage Licenses Tool) to use with this product, but haven't installed the license yet:
 - * Click **Browse for license file**.
 - * In the file explorer, locate and select the license you downloaded. The associated products now appear on the **Licensing** page of the site creation wizard. Select the entry you want to use.

- If the product you want is not displayed, or if you have no allocated and downloaded licenses, you can allocate, download, and install a license. To do this, the License Server must have internet access. You must have a License Access Code for the product you want. Citrix emails that code to you.
 - * Click **Allocate and download**.
 - * In the **Allocate Licenses** dialog, enter the License Access Code sent by Citrix. Click **Allocate licenses**.
 - * The products associated with the new license appear on the **Licensing** page of the site creation wizard. Select the entry you want to use.

Alternatively, select **Use the free 30-day trial**, and install licenses later. For details, see the [Licensing documentation](#).

Step 5. Summary

The **Summary** page lists the information you specified. Use the **Back** button if you want to change anything. When you're finished, click **Finish**.

More information

Host connection, network, and storage

If you are using VMs on a hypervisor or other service to deliver applications and desktops, you can optionally create the first connection to that host. You can also specify storage and network resources for that connection. After creating the site, you can modify this connection and resources, and create more connections. For details, see [Connections and resources](#).

- For information specified on the **Connection** page, see [Connections and resources](#).
 - If you are not using VMs on a hypervisor or other service (or if you use Web Studio to manage desktops on dedicated blade PCs), select the connection type **None**.
 - If you are configuring a Remote PC Access site and plan to use the Wake on LAN feature, select the **Microsoft System Center Virtual Machine Manager** or **Remote PC Wake on LAN** type. For more information, see [Wake on LAN](#).

In addition to the connection type, specify whether you will use Citrix tools (such as Machine Creation Services) or other tools to create VMs.

- For information specified on the **Storage** and **Network** pages, see [Host storage](#), [Storage management](#), and [Storage selection](#).

- If you have Hybrid Rights License and have added public cloud host connections (for example, AWS), those connections are listed here. To view those public cloud host connections, refresh Web Studio several minutes after adding them.

Remote PC Access

For information about Remote PC Access deployments, see [Remote PC Access](#).

If you use the Wake on LAN feature, complete the configuration steps on the Microsoft System Center Configuration Manager before creating the site. For details, see [Configuration Manager and Remote PC Access Wake on LAN](#).

Create and manage connections and resources

March 8, 2024

Important:

As of Citrix Virtual Apps and Desktops 7 2006, if your current deployment uses any of the following technologies, you can upgrade your deployment to the current release only after removing End of Life (EOL) items that use those technologies.

- Personal vDisks (PvDs)
- AppDisks
- Public cloud host types: Citrix CloudPlatform, Microsoft Azure Classic

For details, see [Remove PVD, AppDisks, and unsupported hosts](#).

Note:

You can manage your Citrix Virtual Apps and Desktops deployment using two management consoles: Web Studio (web-based) and Citrix Studio (Windows-based). This article covers only Web Studio. For information about Citrix Studio, see the equivalent article in Citrix Virtual Apps and Desktops 7 2212 or earlier.

If you want to use public cloud host connections to your deployment, you need Hybrid Rights License to complete your fresh installation or upgrade to the current release.

When the installer detects one or more of the unsupported technologies or host connections without Hybrid Rights License, the upgrade pauses or stops, and an explanatory message appears. The installer logs contain details. For more information, see [Upgrade a deployment](#).

Effect of Hybrid Rights License on host connection

There are three scenarios where the host connection to the public cloud hosts is affected based on Hybrid Rights License entitlement:

- To create a new host connection to the public cloud hosts, you must have Hybrid Rights License.
- If you have Hybrid Rights License but the license has expired, then the existing connections to public cloud hosts are marked as not entitled and enter into maintenance mode. When existing host connections are in maintenance mode, you cannot do the following:
 - Add or modify host connections
 - Create catalog and update image
 - Perform power actions
- When not entitled host connections change to entitled, existing hosting connections are re-enabled.

Introduction

You can optionally create your first connection to hosting resources when you create a Site. Later, you can change that connection and create other connections. Configuring a connection includes selecting the connection type from among the supported hypervisors and the storage and network that you select from the resources for that connection.

Read Only Administrators can view connection and resource details. You must be a Full Administrator to perform connection and resource management tasks. For details, see [Delegated administration](#).

Where to find information about connection types

You can use the supported virtualization platforms to host and manage machines in your Citrix Virtual Apps or Citrix Virtual Desktops environment. The [System requirements](#) article lists the supported types.

For details, see the following information sources:

- **XenServer (formerly Citrix Hypervisor):**
 - [XenServer virtualization environments](#).
 - XenServer documentation.
- **Nutanix Acropolis:**
 - [Nutanix virtualization environments](#).

- Nutanix documentation.
- **VMware:**
 - [VMware virtualization environments](#).
 - VMware product documentation.
- **Microsoft Hyper-V:**
 - [Microsoft System Center Virtual Machine Manager virtualization environments](#) article.
 - Microsoft documentation.
- **Public Cloud host connections (AWS, Google Cloud, Microsoft Azure, Nutanix cloud and partner solutions, and VMware cloud and partner solutions):** For information related to public cloud hosts, see [Set up resource type](#).

Note:

The information sources direct you to the Citrix DaaS documentation. If you are familiar with the public cloud hosts in the Citrix DaaS product, the on-premises version has several differences. In on-premises Virtual Apps and Desktops, the management interface is known as Web Studio. Updates are rolled out to the service approximately every four weeks. So, you might find that certain features available with the service are not available with the on-premises version.

Host storage

A storage product is supported when managed by a supported hypervisor. Citrix Support assists those storage product vendors in troubleshooting and resolving issues, and documents those issues in the knowledge center, as needed.

When provisioning machines, data is classified by type:

- Operating system (OS) data, which includes master images.
- Temporary data. This data includes all non-persistent data written to MCS-provisioned machines, Windows page files, user profile data, and any data that is synchronized with ShareFile. This data is discarded each time a machine restarts.

Providing separate storage for each data type can reduce load and improve performance on each storage device, making best use of the host's available resources. It also enables appropriate storage to be used for the different data types—persistence and resilience is more important for some data than others.

Storage can be shared (located centrally, separate from any host, used by all hosts) or local to a hypervisor. For example, central shared storage can be one or more Windows Server 2012 clustered

storage volumes (with or without attached storage), or an appliance from a storage vendor. The central storage might also provide its own optimizations such as hypervisor storage control paths and direct access through partner plug-ins.

Storing temporary data locally avoids having to traverse the network to access shared storage. It also reduces load on the shared storage device. Shared storage can be more costly, so storing data locally can lower expenses. These benefits must be weighed against the availability of sufficient storage on the hypervisor servers.

When you create a connection, you choose one of two storage management methods: storage shared by hypervisors, or storage local to the hypervisor.

When using local storage on one or more XenServer hosts for temporary data storage, make sure that each storage location in the pool has a unique name. (To change a name in XenCenter, right-click the storage and edit the name property.)

Storage shared by hypervisors

The storage shared by hypervisors method stores data that needs longer-term persistence centrally, providing centralized backup and management. That storage holds the OS disks.

When you select this method, you can choose whether to use local storage (on servers in the same hypervisor pool) for temporary machine data. This method does not require persistence or as much resilience as the data in the shared storage, referred to as the *temporary data cache*. The local disk helps reduce traffic to the main OS storage. This disk is cleared after every machine restart. The disk is accessed through a write-through memory cache. If you use local storage for temporary data, the provisioned VDA is tied to a specific hypervisor host. If that host fails, the VM cannot start.

Exception: Microsoft System Center Virtual Machine Manager does not allow temporary data cache disks on local storage when using Clustered Storage Volumes (CSV).

Create a connection to store temporary data locally and then enable and configure nondefault values for each VM's cache disk size and memory size. The default values are tailored to the connection type, and are sufficient for most cases. For details, see [Create machine catalogs](#).

The hypervisor can also provide optimization technologies through read caching of the disk images locally. For example, XenServer offers IntelliCache, which reduces network traffic to the central storage.

Storage local to the hypervisor

The storage local to the hypervisor method stores data locally on the hypervisor. With this method, master images and other OS data are transferred to the hypervisors in the Site. This process occurs for initial machine creation and future image updates. This process results in significant traffic on the

management network. Image transfers are also time-consuming, and the images become available to each host at a different time.

Create a connection and resources

You can optionally create the first connection when you create the Site. The Site creation wizard contains the connection-related pages described in the following sections.

If you are creating a connection after you create the Site, start with step 1.

Important:

The host resources (storage and network) must be available before you create a connection.

1. Sign in to Web Studio.
2. Select **Hosting** in the left pane.
3. Select **Add Connections and Resources** in the action bar.
4. The wizard guides you through the following pages (specific page content depends on the selected connection type). After completing each page, click **Next** until you reach the **Summary** page.

Connection

On the **Connection** page:

- To create a connection, select **Create a new Connection**. To create a connection based on the same host configuration as an existing connection, select **Use an existing Connection** and then choose the relevant connection.
- Select the hypervisor you are using in the **Connection type** field. Public cloud host connections are listed in the drop-down list only if you use Hybrid Rights License. Alternatively, you can use the PowerShell command `Get-HypHypervisorPlugin [-ZoneUid] $ruid [-IncludeUnavailable] false/true` to get the following:
 - List of all Citrix supported hypervisor plugins, including third party plugins.
 - Availability of hypervisor plugin. If the availability status is **false**, possible reason could be that the hypervisor plug-in is not installed correctly or you are not entitled with Hybrid Rights License.
- The connection address and credentials fields differ, depending on the selected connection type. Enter the requested information.
- Enter a connection name. This name appears in Web Studio.

- Choose the tool you use to create virtual machines: Web Studio tools (such as Machine Creation Services or Citrix Provisioning) or other tools.

Storage management

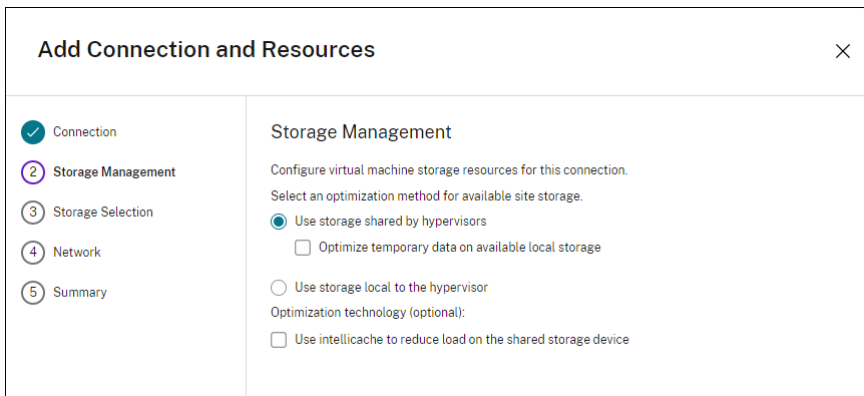

For information about storage management types and methods, see [Host storage](#).

If you are configuring a connection to a Hyper-V or VMware host, browse to and then select a cluster name. Other connection types do not request a cluster name.

Select a storage management method: storage shared by hypervisors or storage local to the hypervisor.

- If you choose storage shared by hypervisors, indicate if you want to keep temporary data on available local storage. (You can specify nondefault temporary storage sizes in the machine catalogs that use this connection.) **Exception:** When using Clustered Storage Volumes (CSV), Microsoft System Center Virtual Machine Manager does not allow temporary data cache disks on local storage. Configuring that storage management setup in Web Studio fails.

If you use shared storage in a XenServer pool, indicate if you want to use IntelliCache to reduce the load on the shared storage device. See [Use IntelliCache for XenServer connections](#).

Storage selection

Add Connection and Resources [X]

Connection
 Storage Management
 Storage Selection
 Network
 Summary

Storage Selection

When using shared storage, you must select the type of data to store on each shared storage device: machine operating system data, personal user data, and if not storing temporary data locally, temporary data. At least one device must be selected for each data type.

Select data storage locations:

▲ A storage location for each type of data must be visible to at least one host.

Name ↓	OS	Temporary
iSCSI GFS2 SR	<input type="checkbox"/>	<input type="checkbox"/>
iSCSI LVM SR (Full Clone)	<input type="checkbox"/>	<input type="checkbox"/>

For more information about storage selection, see [Host storage](#).

Select at least one host storage device for each available data type. The storage management method you selected on the previous page affects which data types are available for selection on this page. Select at least one storage device for each supported data type before you can proceed to the next page in the wizard.

The lower portion of the **Storage Selection** page contains more configuration options if you chose storage shared by hypervisors and enabled **Optimize temporary data on available local storage** on the previous page. You can select which local storage devices to use for temporary data.

The number of currently selected storage devices is shown (in the preceding graphic, “1 storage device selected”). When you hover over that entry, the selected device names appear.

1. Click **Select** to change the storage devices to use.
2. In the **Select Storage** dialog box, select or clear the storage device check boxes, and then click **OK**.

Network

On the **Network** page, enter a name for the resources. This name appears in Web Studio to identify the storage and network combination associated with the connection.

Select one or more networks that the VMs use.

Summary

On the **Summary** page, review your selections. When you're done, click **Finish**.

Remember: Storing temporary data locally allows you to configure nondefault values for temporary data storage when you create the Machine Catalog containing machines using this connection. See [Create Machine Catalogs](#).

Edit connection settings

Do not use this procedure to rename a connection or to create a connection. Those connections are different operations. Change the address only if the current host machine has a new address. Entering an address to a different machine breaks the connection's Machine Catalogs.

You cannot change the **GPU** settings for a connection, because Machine Catalogs accessing this resource must use an appropriate GPU-specific master image. Create a connection.

1. Sign in to Web Studio.
2. Select **Hosting** in the left pane.
3. Select the connection and then select **Edit Connection** in the action bar.
4. Follow the guidance for the settings available when you edit a connection.
5. When you are finished, click **Apply** to apply any changes you made and keep the window open, or click **Save** to apply changes and close the window.

Connection Properties page:

- To change the connection address and credentials, select **Edit settings...** and then enter the new information.
- To specify the high-availability servers for a XenServer connection, select **Edit servers...** and select the servers. Citrix recommends that you select all servers in the pool to allow communication with XenServer if the pool master fails.

Note:

If you are using HTTPS and want to configure high-availability servers, do not install a wildcard certificate for all servers in a pool. An individual certificate for each server is required.

Advanced page:

- For a Microsoft System Center Configuration Manager (ConfMgr) Wake on LAN connection type, which is used with Remote PC Access, enter **ConfMgr Wake Proxy**, magic packets, and packet transmission information.

- The throttling threshold settings enable you to specify a maximum number of power actions allowed on a connection. These settings can help when power management settings allow too many or too few machines to start at the same time. Each connection type has specific default values that are appropriate for most cases and must not be changed.
- The **Simultaneous actions (all types)** setting specifies two values: a maximum absolute number that can occur simultaneously on this connection, and a maximum percentage of all machines that use this connection. You must specify both absolute and percentage values. The actual limit applied is the lower of the values.

For example, in a deployment with 34 machines, if **Simultaneous actions (all types)** is set to an absolute value of 10 and a percentage value of 10, the actual limit applied is 3 (that is, 10 percent of 34 rounded to the nearest whole number, which is less than the absolute value of 10 machines).

- The **Maximum new actions per minute** is an absolute number. There is no percentage value.
- Enter information in the **Connection options** field only under the guidance of a Citrix Support representative or explicit documentation instructions.

Shared Tenants page:

Add tenants and subscriptions that share the Azure Compute Gallery with the subscription of this connection. As a result, when creating or updating catalogs, you can select shared images from those tenants and subscriptions.

- Enter the **Application ID** and **Application secret** for the application associated with this connection. With this information, you can authenticate to Azure. We recommend that you change keys regularly to ensure security.
- Specify shared tenants and subscriptions. You can add up to eight shared tenants. For each tenant, you can add up to eight subscriptions.
- Click **Save** and **Apply** when you're done.

Enter information in the **Connection options** field only under the guidance of a Citrix Support representative.

Edit networks

You can change networks for a connection. Do the following:

1. Go to **Hosting**.
2. Select the target resources under the connection and then select **Edit Network** in the action bar.
3. Select one or more networks for the virtual machines to use.
4. Click **Save** to save your changes and to exit.

Turn maintenance mode on or off for a connection

Turning on maintenance mode for a connection prevents any new power action from affecting any machine stored on the connection. Users cannot connect to a machine when it is in maintenance mode. If users are already connected, maintenance mode takes effect when they log off.

1. Sign in to Web Studio.
2. Select **Hosting** in the left pane.
3. Select the connection. To turn maintenance mode on, select **Turn On Maintenance Mode** in the action bar. To turn maintenance mode off, select **Turn Off Maintenance Mode**.

You can also turn maintenance mode on or off for individual machines. Also, you can turn maintenance mode on or off for machines in Machine Catalogs or Delivery Groups.

Delete a connection

Deleting a connection can result in the deletion of large numbers of machines and loss of data. Ensure that user data on affected machines is backed up or no longer required.

Before deleting a connection, ensure that:

- All users are logged off from the machines stored on the connection.
- No disconnected user sessions are running.
- Maintenance mode is turned on for pooled and dedicated machines.
- All machines in Machine Catalogs used by the connection are powered off.

A Machine Catalog becomes unusable when you delete a connection that is referenced by that catalog. If this connection is referenced by a catalog, you have the option to delete the catalog. Before you delete a catalog, make sure it is not used by other connections.

1. Sign in to Web Studio.
2. Select **Hosting** in the left pane.
3. Select the connection and then select **Delete Connection** in the action bar.
4. If this connection has machines stored on it, you are asked whether the machines should be deleted. If they are to be deleted, specify what should be done with the associated Active Directory computer accounts.

Rename or test a connection

1. Sign in to Web Studio.
2. Select **Hosting** in the left pane.
3. Select the connection and then select **Rename Connection** or **Test Connection** in the action bar.

View machine details on a connection

1. Sign in to Web Studio.
2. Select **Hosting** in the left pane.
3. Select the connection and then select **View Machines** in the action bar.

The upper pane lists the machines accessed through the connection. Select a machine to view its details in the lower pane. Session details are also provided for open sessions.

Use the search feature to find machines quickly. Either select a saved search from the list at the top of the window, or create a search. You can either search by typing all or part of the machine name, or you can build an expression to use for an advanced search. To build an expression, click **Unfold**, and then select from the lists of properties and operators.

Manage machines on a connection

1. Sign in to Web Studio.
2. Select **Hosting** in the left pane.
3. Select a connection and then select **View Machines** in the **Action** pane.
4. Select one of the following in the action bar. Some actions are not available, depending on the machine state and the connection host type.

Action	Description
Start	Starts the machine if it is powered off or suspended.
Suspend	Pauses the machine without shutting it down, and refreshes the list of machines.
Shut down	Requests the operating system to shut down.
Force shut down	Forcibly powers off the machine, and refreshes the list of machines.
Restart	Requests the operating system to shut down and then start the machine again. If the operating system cannot comply, the desktop remains in its current state.

Action	Description
Enable maintenance mode	Temporarily stops connections to a machine. Users cannot connect to a machine in this state. If users are connected, maintenance mode takes effect when they log off. (You can also turn maintenance mode on or off for all machines accessed through a connection, as described above.)
Remove from Delivery Group	Removing a machine from a Delivery Group does not delete it from the Machine Catalog that the Delivery Group uses. You can remove a machine only when no user is connected to it. Turn on maintenance mode to temporarily prevent users from connecting while you are removing the machine.
Delete	When you delete a machine, users no longer have access to it, and the machine is deleted from the Machine Catalog. Before deleting a machine, ensure that all user data is backed up or no longer required. You can delete a machine only when no user is connected to it. Turn on maintenance mode to temporarily stop users from connecting while you are deleting the machine.

For actions that involve machine shutdown, if the machine does not shut down within 10 minutes, it is powered off. If Windows attempts to install updates during shutdown, there is a risk that the machine is powered off before the updates are complete.

Edit storage

You can display the status of servers that are used to store operating system and temporary data for VMs that use a connection. You can also specify which servers to use for storage of each data type.

1. Sign in to Web Studio.
2. Select **Hosting** in the left pane.
3. Select the connection and then select **Edit Storage** in the action bar.
4. In the left pane, select the data type: operating system, or temporary.

5. Select or clear the check boxes for one or more storage devices for the selected data type.
6. Click **OK**.

Each storage device in the list includes its name and storage status. Valid storage status values are:

- **In use:** The storage is being used for creating machines.
- **Superseded:** The storage is being used only for existing machines. No new machines are added in this storage.
- **Not in use:** The storage is not being used for creating machines.

If you clear the check box for a device that is currently **In use**, its status changes to **Superseded**. Existing machines will continue to use that storage device (and can write data to it), so it is possible for that location to become full even after it stops being used for creating machines.

Delete, rename, or test resources

1. Sign in to Web Studio.
2. Select **Hosting** in the left pane.
3. Select the resource and then select the appropriate entry in the action bar: **Delete Resources**, **Rename Resources**, or **Test Resources**.

Detect Orphaned Azure resources

Orphaned resources are unused resources present in the system and they can lead to unnecessary expenses.

This feature allows you to detect the orphaned Azure resources in the hosts on your Citrix Virtual Apps and Desktops site.

Follow the steps on Web Studio:

1. From **Manage**, select **Hosting** in the left pane.
2. Select a connection, and then select **Detect Orphaned Resources** in the action bar. The **Detect Orphaned Resources** dialog box displays the orphaned resource report.
3. To view the orphaned resource report, select **View Report**.

Alternatively, you can detect orphaned Azure resources using PowerShell. For more information, see [Retrieve a list of orphaned resources](#).

To understand the reasons behind the orphaned resources, and to learn how to proceed further, see [Efficiently manage Orphaned Azure resources with Citrix](#).

Connection timers

You can use policy settings to configure three connection timers:

- **Maximum connection timer:** Determines the maximum duration of an uninterrupted connection between a user device and a virtual desktop. Use the **Session connection timer** and **Session connection timer interval** policy settings.
- **Connection idle timer:** Determines how long an uninterrupted user device connection to a virtual desktop is maintained if there is no input from the user. Use the **Session idle timer** and **Session idle timer interval** policy settings.
- **Disconnect timer:** Determines how long a disconnected, locked virtual desktop can remain locked before the session is logged off. Use the **Disconnected session timer** and **Disconnected session timer interval** policy settings.

When you update any of these settings, ensure they are consistent across your deployment.

See the policy settings documentation for more information.

Retrieve a list of orphaned resources

You can get a list of orphaned resources that are created by MCS but are no longer tracked by MCS. This is currently applicable to Azure environments. To get the list, you can use PowerShell commands. You can filter using connections.

Note:

- The PowerShell command is rejected if any provisioning or image update is in progress.
- A customer-managed resource tagged with all Citrix tags is detected as an orphaned resource. However, if you add another tag `CitrixDetectIgnore` with value as `true` to that resource, then the resource is ignored while detecting orphaned resources.

Limitations

- Only a built-in full admin or cloud admin role admin user can run the PowerShell command and get the list of orphaned resources.
- To avoid incorrect recognition of orphaned resources, do not power on VMs while you are filtering orphaned resources.
- Around 2,000 records are displayed as orphaned in case of possible heavy workload.

To display the list of orphaned resources:

1. Open a **PowerShell** window.

2. Run the following commands:

- a) Get the connection uid. The connection uid is the value of the HypervisorConnectionUid attribute.

```
1 Get-ChildItem xdhyp:\connections | where {
2     $_.PluginId -like 'Azure*' }
3     "
4 <!--NeedCopy-->
```

- b) Get the list of orphaned resources.

```
1 get-provorphanedresource -HypervisorConnectionUid <connection
   uid>
2 <!--NeedCopy-->
```

To display the list of orphaned resources from an subscription id:

1. Open a **PowerShell** window.

2. Run the following commands:

- a) Find the connection uid using the subscription ID. The connection uid is the value of the HypervisorConnectionUid attribute.

```
1 Get-ChildItem xdhyp:\connections | where {
2     $_.CustomProperties -match '<subscriptionId>' }
3
4 <!--NeedCopy-->
```

- b) Get the list of orphaned resources:

```
1 get-provorphanedresource -HypervisorConnectionUid <connection
   uid>
2 <!--NeedCopy-->
```

Note:

Check the resources carefully before deleting.

Where to go next

For information on connection to specific host types, see:

- [Connection to AWS](#)
- [Connection to XenServer](#)
- [Connection to Google cloud environments](#)
- [Connection to Microsoft Azure](#)
- [Connection to Microsoft System Center Virtual Machine Manager](#)

- [Connection to Nutanix](#)
- [Connection to Nutanix cloud and partner solutions](#)
- [Connection to VMware](#)
- [Connection to VMware cloud and partner solutions](#)

If you're in the initial deployment process, [create a machine catalog](#).

Connection to AWS

March 8, 2024

[Create and manage connections and resources](#) describes the wizards that create a connection. The following information covers details specific to AWS cloud environments.

Note:

Before creating a connection to AWS, you need to first finish setting up your AWS account as a resource location. See [AWS cloud environments](#).

Create a connection

When you create a connection from Web Studio:

- You must provide the API key and secret key values. You can export the key file containing those values from AWS and then import them. You must also provide the region, availability zone, VPC name, subnet addresses, domain name, security group names, and credentials.
- The credentials file for the root AWS account (retrieved from the AWS console) is not formatted the same as credentials files downloaded for standard AWS users. Therefore, Citrix Virtual Apps and Desktops management cannot use the file to populate the API key and secret key fields. Ensure that you are using AWS Identity Access Management (IAM) credentials files.

Note:

After you create a connection, attempts to update the API key and secret key might fail. To resolve the issue, check your proxy server or firewall restrictions and ensure that the following address is contactable: https://*.amazonaws.com.

Host connection default values

When you create host connections in AWS cloud environments, the following default values are displayed:

Option	Absolute	Percentage
Simultaneous actions (all types)	125	100
Maximum new actions per minute	125	

MCS supports 100 maximum concurrent provisioning operations by default.

Service endpoint URL

Standard zone service endpoint URL

When you use MCS, a new AWS connection is added with an API key and an API secret. With this information, along with the authenticated account, MCS queries AWS for the supported zones using the AWS DescribeRegions EC2 API call. The query is made using a generic EC2 Service Endpoint URL <https://ec2.amazonaws.com/>. Use MCS to select the zone for the connection from the list of supported zones. The preferred AWS service endpoint URL is automatically selected for the zone. However, after you create the service endpoint URL, you can no longer set or modify the URL.

Define IAM permissions

Use the information in this section to define IAM permissions for Citrix Virtual Apps and Desktops on AWS. Amazon's IAM service permits accounts having multiple users, which can be further organized into groups. These users can possess different permissions to control their ability to perform operations associated with the account. For more information about IAM permissions, see [IAM JSON policy reference](#).

To apply IAM permissions policy to a new group of users:

1. Log in to the AWS management console and select the **IAM service** from the drop-down list.
2. Select **Create a New Group of Users**.
3. Type a name for the new user group and select **Continue**.
4. On the **Permissions** page, choose **Custom Policy**. Select **Select**.
5. Type a name for the **Permissions policy**.
6. In the **Policy Document** section, enter relevant permissions.

After entering the policy information, select **Continue** to complete the group of users. Users in the group are granted permissions to perform only those actions that are required for Citrix Virtual Apps and Desktops.

Important:

Use the policy text provided in the example earlier to list the actions that Citrix Virtual Apps and Desktops uses to perform actions within an AWS account without restricting those actions to specific resources. Citrix recommends that you use the example for testing purposes. For production environments, you might choose to add further restrictions on resources.

Set IAM permissions

Set the permissions in the **IAM** section of the AWS Management Console:

1. In the **Summary** panel, select the **Permissions** tab.
2. Select **Add permissions**.

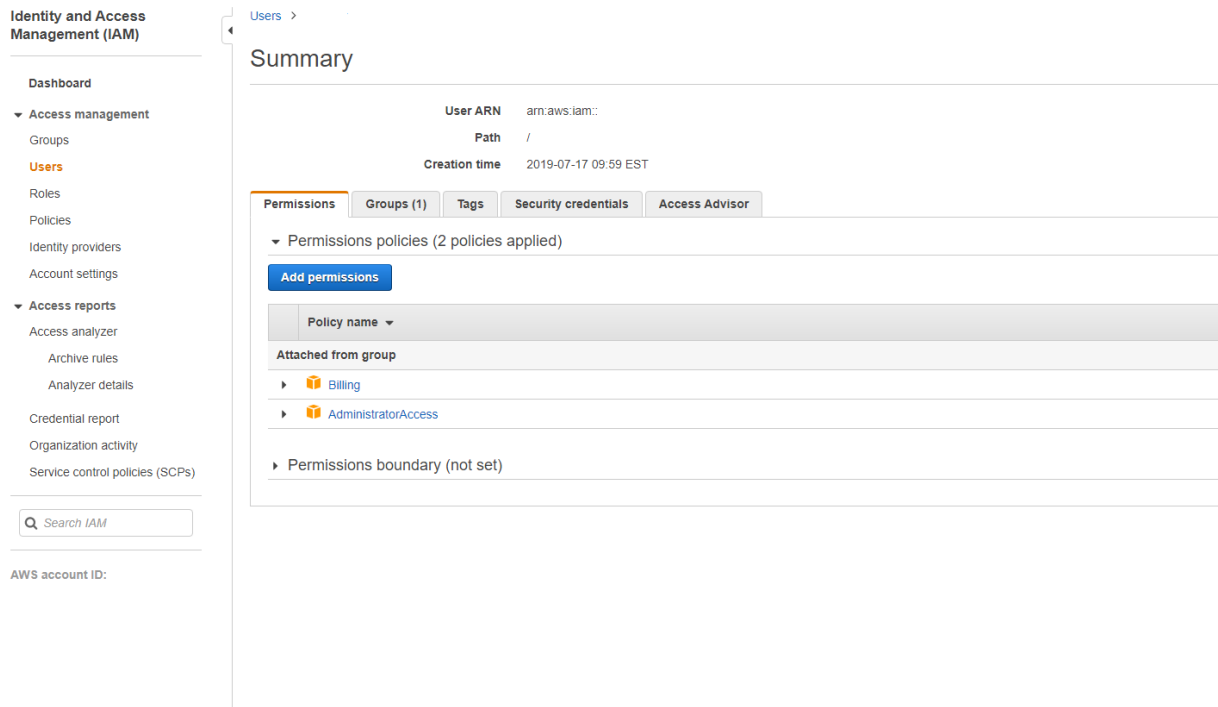

In the **Add Permissions to** screen, grant permissions:

Add permissions to

Grant permissions

Use IAM policies to grant permissions. You can assign an existing policy or create a new one.

Filter policies	Search	Policy name	Type	Used as
<input type="checkbox"/>		AdministratorAccess	Job function	Permissions policy (8)
<input type="checkbox"/>		AlexaForBusinessDeviceSetup	AWS managed	None
<input type="checkbox"/>		AlexaForBusinessFullAccess	AWS managed	None
<input type="checkbox"/>		AlexaForBusinessGatewayExecution	AWS managed	None
<input type="checkbox"/>		AlexaForBusinessPolyDelegatedAccessPolicy	AWS managed	None
<input type="checkbox"/>		AlexaForBusinessReadOnlyAccess	AWS managed	None
<input type="checkbox"/>		AmazonAPIGatewayAdministrator	AWS managed	None
<input type="checkbox"/>		AmazonAPIGatewayInvokeFullAccess	AWS managed	None

Use the following as an example in the **JSON** tab:

Create policy

1 2

A policy defines the AWS permissions that you can assign to a user, group, or role. You can create and edit a policy in the visual editor and using JSON. [Learn more](#)

```

1 {
2   "Version": "2012-10-17",
3   "Statement": [
4     {
5       "Sid": "VisualEditor0",
6       "Effect": "Allow",
7       "Action": [
8         "ec2:CreateTags",
9         "ec2:DeleteTags",
10        "ec2:DescribeTags",
11        "ec2:PutObjectTagging",
12        "ec2:PutBucketTagging"
13      ],
14      "Resource": "*"
15    },
16    {
17      "Sid": "VisualEditor1",
18      "Effect": "Allow",
19      "Action": "iam:PassRole",
20      "Resource": "arn:aws:iam:*:role/*"
21    }
22  ]
23 }
    
```

Character count: 304 of 6,144.

Tip:

The noted JSON example might not include all the permissions for your environment. See [How to Define Identity Access Management Permissions Running Citrix Virtual Apps and Desktops on AWS](#) for more information.

Required AWS permissions

This section contains the complete list of AWS permissions.

Note:

The `iam:PassRole` permission is needed only for **role_based_auth**.

Creating a host connection

A new host connection is added using the information from AWS.

```
1 {
2
3     "Version": "2012-10-17",
4     "Statement": [
5         {
6
7             "Action": [
8                 "ec2:DescribeAvailabilityZones",
9                 "ec2:DescribeImages",
10                "ec2:DescribeInstances",
11                "ec2:DescribeInstanceTypes",
12                "ec2:DescribeSecurityGroups",
13                "ec2:DescribeSubnets",
14                "ec2:DescribeVpcs"
15            ],
16            "Effect": "Allow",
17            "Resource": "*"
18        }
19    ]
20 }
21 }
22
23 <!--NeedCopy-->
```

Power management of VMs

Machine instances are powered on or off.

```
1 {
2
3     "Version": "2012-10-17",
4     "Statement": [
5         {
6
7             "Action": [
8                 "ec2:AttachVolume",
9                 "ec2:CreateVolume",
```

```

10         "ec2:DeleteVolume",
11         "ec2:DescribeInstances",
12         "ec2:DescribeVolumes",
13         "ec2:DetachVolume",
14         "ec2:StartInstances",
15         "ec2:StopInstances"
16     ],
17     "Effect": "Allow",
18     "Resource": "*"
19 }
20
21 ]
22 }
23
24 <!--NeedCopy-->

```

Creating, updating, or deleting VMs

A machine catalog is created, updated, or deleted with VMs provisioned as AWS instances.

```

1 {
2
3     "Version": "2012-10-17",
4     "Statement": [
5         {
6
7             "Action": [
8                 "ec2:AttachVolume",
9                 "ec2:AssociateIamInstanceProfile",
10                "ec2:AuthorizeSecurityGroupEgress",
11                "ec2:AuthorizeSecurityGroupIngress",
12                "ec2:CreateImage",
13                "ec2:CreateLaunchTemplate",
14                "ec2:CreateSecurityGroup",
15                "ec2:CreateTags",
16                "ec2:CreateVolume",
17                "ec2>DeleteVolume",
18                "ec2:DescribeAccountAttributes",
19                "ec2:DescribeAvailabilityZones",
20                "ec2:DescribeIamInstanceProfileAssociations",
21                "ec2:DescribeImages",
22                "ec2:DescribeInstances",
23                "ec2:DescribeInstanceTypes",
24                "ec2:DescribeLaunchTemplates",
25                "ec2:DescribeLaunchTemplateVersions",
26                "ec2:DescribeNetworkInterfaces",
27                "ec2:DescribeRegions",
28                "ec2:DescribeSecurityGroups",
29                "ec2:DescribeSnapshots",
30                "ec2:DescribeSubnets",
31                "ec2:DescribeTags",
32                "ec2:DescribeVolumes",

```

```
33         "ec2:DescribeVpcs",
34         "ec2:DetachVolume",
35         "ec2:DisassociateIamInstanceProfile",
36         "ec2:RunInstances",
37         "ec2:StartInstances",
38         "ec2:StopInstances",
39         "ec2:TerminateInstances"
40     ],
41     "Effect": "Allow",
42     "Resource": "*"
43 },
44 ,
45 {
46     "Action": [
47         "ec2:AuthorizeSecurityGroupEgress",
48         "ec2:AuthorizeSecurityGroupIngress",
49         "ec2:CreateSecurityGroup",
50         "ec2>DeleteSecurityGroup",
51         "ec2:RevokeSecurityGroupEgress",
52         "ec2:RevokeSecurityGroupIngress"
53     ],
54     "Effect": "Allow",
55     "Resource": "*"
56 },
57 ,
58 {
59     "Action": [
60         "s3:CreateBucket",
61         "s3>DeleteBucket",
62         "s3:PutBucketAcl",
63         "s3:PutBucketTagging",
64         "s3:PutObject",
65         "s3:GetObject",
66         "s3>DeleteObject",
67         "s3:PutObjectTagging"
68     ],
69     "Effect": "Allow",
70     "Resource": "arn:aws:s3:::citrix*"
71 },
72 ,
73 {
74     "Action": [
75         "ebs:StartSnapshot",
76         "ebs:GetSnapshotBlock",
77         "ebs:PutSnapshotBlock",
78         "ebs:CompleteSnapshot",
79         "ebs:ListSnapshotBlocks",
80         "ebs:ListChangedBlocks",
81         "ec2:CreateSnapshot"
82     ],
83     "Effect": "Allow",
84     "Resource": "*"
85 }
```

```
86         "Effect": "Allow",
87         "Resource": "*"
88     }
89
90 ]
91 }
92
93 <!--NeedCopy-->
```

Note:

The EC2 section related to security groups is only needed if an isolation security group must be created for the preparation VM during catalog creation. Once this is done, these permissions are not required.

Direct disk upload and download Direct disk upload eliminates the volume worker requirement for machine catalog provisioning, and instead uses public APIs provided by AWS. This functionality reduces the cost associated with extra storage accounts and the complexity for maintaining volume worker operations.

Note:

The support for volume worker is deprecated.

Following permissions must be added to the policy:

- ebs:StartSnapshot
- ebs:GetSnapshotBlock
- ebs:PutSnapshotBlock
- ebs:CompleteSnapshot
- ebs:ListSnapshotBlocks
- ebs:ListChangedBlocks
- ec2:CreateSnapshot
- ec2:DescribeLaunchTemplates

Important:

- You can add a VM to existing machine catalogs without any volume worker operation such as volume worker AMI, and volume worker VM.
- If you delete an existing catalog that used volume worker before, all artifacts including volume worker related are deleted.

EBS encryption of created volumes

EBS can auto-encrypt newly created volumes if the AMI is encrypted, or EBS is configured to encrypt all new volumes. However, to implement the functionality, the following permissions must be included in the IAM policy.

```

1  {
2
3      "Version": "2012-10-17",
4      "Statement": [
5          {
6
7              "Effect": "Allow",
8              "Action": [
9                  "kms:CreateGrant",
10                 "kms:Decrypt",
11                 "kms:DescribeKey",
12                 "kms:GenerateDataKeyWithoutPlainText",
13                 "kms:ReEncryptTo",
14                 "kms:ReEncryptFrom"
15             ],
16             "Resource": "*"
17         }
18     ]
19 }
20 }
21
22 <!--NeedCopy-->

```

Note:

The permissions can be limited to specific keys by including a Resource and Condition block at the discretion of the user. For example, **KMS Permissions with Condition**:

```

1  {
2
3      "Version": "2012-10-17",
4      "Statement": [
5          {
6
7              "Effect": "Allow",
8              "Action": [
9                  "kms:CreateGrant",
10                 "kms:Decrypt",
11                 "kms:DescribeKey",
12                 "kms:GenerateDataKeyWithoutPlainText",
13                 "kms:ReEncryptTo",
14                 "kms:ReEncryptFrom"
15             ],
16             "Resource": [
17                 "arn:aws:kms:us-east-2:123456789012:key/abcd1234-a123-456d-a12b-a123b4cd56ef"

```

```

18         ],
19         "Condition": {
20             "Bool": {
21                 "kms:GrantIsForAWSResource": true
22             }
23         }
24     }
25 }
26 }
27 }
28 }
29 }
30 ]
31 }
32 }
33 <!--NeedCopy-->

```

The following key policy statement is the entire default key policy for KMS keys that is required to allow the account to use IAM policies to delegate permission for all actions (kms:*) on the KMS key.

```

1 {
2   "Sid": "Enable IAM policies",
3   "Effect": "Allow",
4   "Principal": {
5     "AWS": "arn:aws:iam::111122223333:root"
6   }
7   ,
8   "Action": "kms:",
9   "Resource": ""
10 }
11 }
12 }
13 }
14 <!--NeedCopy-->

```

For more information, see [AWS Key Management Service official documentation](#).

IAM role-based authentication

The following permissions are added to support role-based authentication.

```

1 {
2   "Version": "2012-10-17",
3   "Statement": [
4     {
5       "Effect": "Allow",
6       "Action": "iam:PassRole",
7       "Resource": "arn:aws:iam::*:role/*"
8     }
9   ]
10 }

```

```
11
12   ]
13 }
14
15 <!--NeedCopy-->
```

Minimal IAM permissions policy

The following JSON can be used for all currently supported features. You can create host connections, create, update, or delete VMs, and do power management using this policy.

The policy can be applied to the users as explained in Define IAM permissions sections or you can also use role-based authentication using **role_based_auth** security key and secret key.

Important:

To use **role_based_auth**, first configure the desired IAM role on all Delivery Controllers in our site. Using Web Studio, add the hosting connection and supply the `role_based_auth` for the authentication key and secret. A hosting connection with these settings then uses role-based authentication.

```
1 {
2
3   "Version": "2012-10-17",
4   "Statement": [
5     {
6
7       "Action": [
8         "ec2:AttachVolume",
9         "ec2:AssociateIamInstanceProfile",
10        "ec2:AuthorizeSecurityGroupEgress",
11        "ec2:AuthorizeSecurityGroupIngress",
12        "ec2:CreateImage",
13        "ec2:CreateLaunchTemplate",
14        "ec2:CreateNetworkInterface",
15        "ec2:CreateTags",
16        "ec2:CreateVolume",
17        "ec2>DeleteLaunchTemplate",
18        "ec2>DeleteNetworkInterface",
19        "ec2>DeleteSecurityGroup",
20        "ec2>DeleteSnapshot",
21        "ec2>DeleteTags",
22        "ec2>DeleteVolume",
23        "ec2:DeregisterImage",
24        "ec2:DescribeAccountAttributes",
25        "ec2:DescribeAvailabilityZones",
26        "ec2:DescribeIamInstanceProfileAssociations",
27        "ec2:DescribeImages",
28        "ec2:DescribeInstances",
29        "ec2:DescribeInstanceTypes",
```

```
30         "ec2:DescribeLaunchTemplates",
31         "ec2:DescribeLaunchTemplateVersions",
32         "ec2:DescribeNetworkInterfaces",
33         "ec2:DescribeRegions",
34         "ec2:DescribeSecurityGroups",
35         "ec2:DescribeSnapshots",
36         "ec2:DescribeSubnets",
37         "ec2:DescribeTags",
38         "ec2:DescribeVolumes",
39         "ec2:DescribeVpcs",
40         "ec2:DetachVolume",
41         "ec2:DisassociateIamInstanceProfile",
42         "ec2:RebootInstances",
43         "ec2:RunInstances",
44         "ec2:StartInstances",
45         "ec2:StopInstances",
46         "ec2:TerminateInstances"
47     ],
48     "Effect": "Allow",
49     "Resource": "*"
50 },
51 ,
52 {
53     "Action": [
54         "ec2:AuthorizeSecurityGroupEgress",
55         "ec2:AuthorizeSecurityGroupIngress",
56         "ec2:CreateSecurityGroup",
57         "ec2>DeleteSecurityGroup",
58         "ec2:RevokeSecurityGroupEgress",
59         "ec2:RevokeSecurityGroupIngress"
60     ],
61     "Effect": "Allow",
62     "Resource": "*"
63 },
64 ,
65 {
66     "Action": [
67         "s3:CreateBucket",
68         "s3>DeleteBucket",
69         "s3>DeleteObject",
70         "s3:GetObject",
71         "s3:PutBucketAcl",
72         "s3:PutObject",
73         "s3:PutBucketTagging",
74         "s3:PutObjectTagging"
75     ],
76     "Effect": "Allow",
77     "Resource": "arn:aws:s3:::citrix*"
78 },
79 ,
80 {
81     "Action": [
82         "ec2:DescribeLaunchTemplates",
```



```

83
84     "Action": [
85         "ebs:StartSnapshot",
86         "ebs:GetSnapshotBlock",
87         "ebs:PutSnapshotBlock",
88         "ebs:CompleteSnapshot",
89         "ebs:ListSnapshotBlocks",
90         "ebs:ListChangedBlocks",
91         "ec2:CreateSnapshot"
92     ],
93     "Effect": "Allow",
94     "Resource": "*"
95 },
96 {
97     "Effect": "Allow",
98     "Action": [
99         "kms:CreateGrant",
100        "kms:Decrypt",
101        "kms:DescribeKey",
102        "kms:GenerateDataKeyWithoutPlainText",
103        "kms:GenerateDataKey",
104        "kms:ReEncryptTo",
105        "kms:ReEncryptFrom"
106    ],
107    "Resource": "*"
108 },
109 {
110     "Effect": "Allow",
111     "Action": "iam:PassRole",
112     "Resource": "arn:aws:iam::*:role/*"
113 }
114 ],
115 }
116 <!--NeedCopy-->

```

Note:

- The EC2 section related to SecurityGroups is only needed if an Isolation Security Group must be created for the Preparation VM during catalog creation. Once this is done, these permissions are not required.
- The KMS section is only required when using EBS volume encryption.
- The iam:PassRole permission section is needed only for **role_based_auth**.
- Specific resource-level permissions can be added instead of full access based on your requirements and environment. Refer to AWS documents [Demystifying EC2 Resource-Level](#)

[Permissions](#) and [Access management for AWS resources](#) for more details.

Where to go next

- If you're in the initial deployment process, see [Create machine catalogs](#)
- For AWS specific information, see [Create an AWS catalog](#)

More information

- [Connections and resources](#)
- [Create machine catalogs](#)

Connection to XenServer

April 16, 2024

[Create and manage connections and resources](#) describes the wizards that create a connection. The following information covers details specific to XenServer virtualization environments.

Note:

Before creating a connection to XenServer, you need to first finish setting up your XenServer account as a resource location. See [XenServer virtualization environments](#).

Create a connection to XenServer

When you create a connection to XenServer (formerly Citrix Hypervisor), you must provide the credentials for a VM Power Admin or higher-level user.

Citrix recommends using HTTPS to secure communications with XenServer. To use HTTPS, you must replace the default SSL certificate installed on XenServer; see [CTX128656](#).

You can configure high availability if it is enabled on the XenServer server. Citrix recommends that you select all servers in the pool (from Edit High Availability) to allow communication with the XenServer server if the pool master fails.

You can select a GPU type and group, or pass through, if the XenServer supports vGPU. The display indicates if the selection has dedicated GPU resources.

When using local storage on one or more XenServer hosts for temporary data storage, make sure that each storage location in the pool has a unique name. (To change a name in XenCenter, right-click the storage and edit the name property.)

You can use Citrix Provisioning (formerly Provisioning Services) and Machine Creation Services (MCS) to provision:

- legacy BIOS for supported Desktop or Server OS VMs.
- UEFI for supported Desktop or Server OS VMs, including Secure Boot.

Note:

Pool operator permissions or higher are required when configuring MCS.

Use IntelliCache for XenServer connections

Using IntelliCache, hosted VDI deployments are more cost-effective because you can use a combination of shared storage and local storage. This enhances performance and reduces network traffic. The local storage caches the master image from the shared storage, which reduces the number of reads on the shared storage. For shared desktops, writes to the differencing disks are written to local storage on the host and not to shared storage.

- Shared storage must be NFS when using IntelliCache.
- Citrix recommends that you use a high performance local storage device to ensure the fastest possible data transfer.

To use IntelliCache, you must enable it in both this product and XenServer.

- When installing XenServer, select **Enable thin provisioning (Optimized storage for Virtual Desktops)**. Citrix does not support mixed pools of servers that have IntelliCache enabled and servers that do not. For more information, see the XenServer documentation.
- In Citrix Virtual Apps and Desktops, IntelliCache is disabled by default. You can change the setting only when creating a XenServer connection; you cannot disable IntelliCache later. When you add a XenServer connection:
 - Select **Shared** as the storage type.
 - Select the **Use IntelliCache** check box.

Required XenServer permissions

The XenServer permissions are role-based (RBAC). The Role-Based Access Control (RBAC) feature in XenServer allows you to assign users, roles, and permissions to control who has access to your XenServer and what actions they can perform. The XenServer RBAC system maps a user (or a group of users) to defined roles (a named set of permissions). The roles have associated XenServer permissions to perform certain operations.

For more information, see [Role-based access control](#).

The role hierarchy, in order of increasing permissions is: Read-Only → VM Operator → VM Admin → VM Power Admin → Pool Operator → Pool Admin.

The following section summarizes the minimum role required for each provisioning task.

Creating a host connection

Task	Minimum role required
Add a host connection using the information obtained from XenServer	Read-Only
View users and their assigned role	Read-Only

Power management of VMs

Task	Minimum role required
Power on or off the VMs	VM Operator

Creating, updating, or deleting VMs

Task	Minimum role required
Add or remove VMs to existing snapshots schedules	VM Power Admin
Add, modify, delete snapshot schedules	Pool Operator
Publish master image	Pool Operator (Requires switch-port locking)
Create a machine catalog	Pool Operator: Requires switch-port locking
Add or remove VMs (not GPU enabled VMs)	VM Admin
Add or remove VMs (GPU enabled VMs)	Pool Operator
Add, remove, or configure virtual disk or CD devices	VM Admin
Manage Tags	VM Operator

For more information on RBAC roles and permissions, see [RBAC roles and permissions](#).

For information on switch port locking, see [Use switch port locking](#).

Where to go next

- If you're in the initial deployment process, see [Create machine catalogs](#)
- For XenServer specific information, see [Create a XenServer catalog](#)

More information

- [Connections and resources](#)
- [Create machine catalogs](#)

Connection to Google cloud environments

April 4, 2024

[Create and manage connections and resources](#) describes the wizards that create a connection. The following information covers details specific to Google cloud environments.

Note:

Before creating a connection to Google cloud environments, you need to first finish setting up your Google cloud account as a resource location. See [Google Cloud environments](#).

Add a connection

Follow the guidance in [Create a connection and resources](#). The following description guides you through setting up a hosting connection:

1. From **Manage > Configuration**, select **Hosting** in the left pane.
2. Select **Add Connection and Resources** in the action bar.
3. On the **Connection** page, select **Create a new Connection** and **Citrix provisioning tools**, and then select **Next**.
 - **Connection type.** Select **Google Cloud** from the menu.
 - **Connection name.** Type a name for the connection.
4. On the **Region** page, select a project name from the menu, select a region containing the resources you want to use, and then select **Next**.

5. On the **Network** page, type a name for the resources, select a virtual network from the menu, select a subset, and then select **Next**. The resource name helps identify the region and network combination. Virtual networks with the (*Shared*) suffix appended to their name represent shared VPCs. If you configure a subnet-level IAM role for a shared VPC, only specific subnets of the shared VPC appear on the subnet list.

Note:

- The resource name can contain 1–64 characters, and cannot contain only blank spaces or the characters \ / ; : # . * ? = < > | [] { } " ' () ').

6. On the **Summary** page, confirm the information and then select **Finish** to exit the **Add Connection and Resources** window.

After creating the connection and resources, the connection and resources you created are listed. To configure the connection, select the connection and then select the applicable option in the action bar.

Similarly, you can delete, rename, or test the resources created under the connection. To do so, select the resource under the connection and then select the applicable option in the action bar.

Service endpoint URLs

You must have access to the following URLs:

- <https://oauth2.googleapis.com>
- <https://cloudresourcemanager.googleapis.com>
- <https://compute.googleapis.com>
- <https://storage.googleapis.com>
- <https://cloudbuild.googleapis.com>

Google Cloud projects

There are basically two types of Google Cloud projects:

- Provisioning project: In this case, the current admin account owns the provisioned machines in the project. This project is also referred to as a local project.
- Shared VPC project: Project in which machines created in the provisioning project use the VPC from the Shared VPC project. The admin account used for provisioning project has limited permissions in this project, specifically, only permissions to use the VPC.

Create a secure environment for GCP managed traffic

You can allow private Google access to your Google Cloud projects. This implementation enhances security to handle sensitive data. To achieve this, you can do one of the following:

- Include the following ingress rules of VPC service controls for Cloud Build Service Account. If you do this step, then do not follow the steps below for creating a secure environment for GCP managed traffic.

```
1  Ingress Rule 1
2  From:
3  Identities:
4  <ProjectID>@cloudbuild.gserviceaccount.com
5  Source > All sources allowed
6  To:
7  Projects =
8  All projects
9  Services =
10 Service name: All services
11 <!--NeedCopy-->
```

- If you are using a private worker pool, add `UsePrivateWorkerPool` in `CustomProperties`. For information on the private worker pool, see [Private pools overview](#).

Requirements to create a secure environment for GCP managed traffic

The requirements to create a secure environment for GCP managed traffic are:

- Ensure that the hosting connection is in maintenance mode when updating the custom properties.
- To use private worker pools, the following changes are required:
 - For Citrix Cloud Service Account, add the following IAM roles:
 - * Cloud Build Service Account
 - * Compute Instance Admin
 - * Service Account User
 - * Service Account Token Creator
 - * Cloud Build WorkerPool Owner
 - Create the Citrix Cloud Service Account in the same project that you use for creating a hosting connection.
 - Set up DNS zones for `private.googleapis.com` and `gcr.io` as described in [DNS configuration](#).

Zone details [EDIT](#) [ADD NETWORKS](#) [DELETE ZONE](#)

googleapis-com-private

DNS name: googleapis.com.
Type: Private

RECORD SETS IN USE BY

[ADD STANDARD](#) [ADD WITH ROUTING POLICY](#) [DELETE RECORD SETS](#) [REFRESH](#)

Filter Filter record sets

<input type="checkbox"/>	DNS name ↑	Type	TTL (seconds)	Routing policy		
<input type="checkbox"/>	*.googleapis.com.	CNAME	300	Default	▼	✎
<input type="checkbox"/>	googleapis.com.	NS	21600	Default	▼	✎
<input type="checkbox"/>	googleapis.com.	SOA	21600	Default	▼	✎
<input type="checkbox"/>	private.googleapis.com.	A	300	Default	▼	✎

Zone details [EDIT](#) [ADD NETWORKS](#) [DELETE ZONE](#)

gcr

DNS name: gcr.io.
Type: Private

RECORD SETS IN USE BY

[ADD STANDARD](#) [ADD WITH ROUTING POLICY](#) [DELETE RECORD SETS](#) [REFRESH](#)

Filter Filter record sets

<input type="checkbox"/>	DNS name ↑	Type	TTL (seconds)	Routing policy		
<input type="checkbox"/>	*.gcr.io.	CNAME	300	Default	▼	✎
<input type="checkbox"/>	gcr.io.	SOA	21600	Default	▼	✎
<input type="checkbox"/>	gcr.io.	NS	21600	Default	▼	✎
<input type="checkbox"/>	gcr.io.	A	300	Default	▼	✎

- Set up private Network Address Translation (NAT) or use private service connect. For more information, see [Access Google APIs through endpoints](#).

Private Service Connect

CONNECTED ENDPOINTS PUBLISHED SERVICES

Private Service Connect lets you connect privately and securely to Services. [Learn more](#)

Connections: 1 in total. Accepted: 1. Rejected: 0. Pending: 0. Closed: 0.

Endpoints [CONNECT ENDPOINT](#)

Filter Enter property name or value

<input type="checkbox"/>	Endpoint ↑	Status	PSC Connection ID	Target	Network	Region	IP address	Namespace	
<input type="checkbox"/>	connectendpoint	Accepted	42924925526780928	All Google APIs	pkm-vpc		10.8.172.0	goog-psc-pkm-vpc-8514753636491831765	⋮

Load balancer endpoints

Filter Enter property name or value

Load balancer ↑	Type	Number of NEGs	Network	Region	IP addresses
No rows to display					

- If using a peered VPC, create a Cloud DNS zone peering to the peered VPC. For more information, see [Create a peering zone](#).

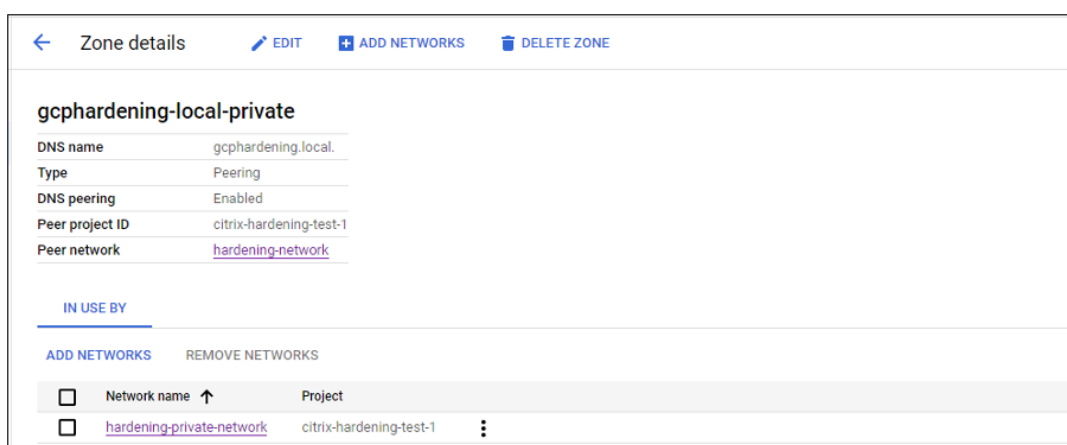

- In VPC service controls, set up Egress rules so that the APIs and VMs can talk to the internet. Ingress rules are optional. For example:

```

1  Egress Rule 1
2  From:
3  Identities:ANY_IDENTITY
4  To:
5  Projects =
6  All projects
7  Service =
8  Service name: All services
9  <!--NeedCopy-->

```

Enable the private worker pool

To enable the private worker pool, set the custom properties as follows on the host connection:

1. Open a PowerShell window from the Delivery Controller host or use the Remote PowerShell SDK. For more information on Remote PowerShell SDK, see [SDKs and APIs](#).
2. Run the following commands:
 - a) `Add-PSSnapin citrix*`
 - b) `cd XDHyp:\Connections\`
 - c) `dir`
3. Copy the `CustomProperties` from the connection to a notepad.
4. Append `property setting <Property xsi:type="StringProperty"Name="UsePrivateWorkerPool"Value="True"/>`. For example:

```

1  ' '
2  <CustomProperties xmlns:xsi="http://www.w3.org/2001/XMLSchema-
   instance" xmlns="http://schemas.citrix.com/2014/xd/
   machinecreation">

```

```

3 <Property xsi:type="StringProperty" Name="UsePrivateWorkerPool"
  Value="True"/>
4 </CustomProperties>
5 <!--NeedCopy--> ````

```

5. In the PowerShell window, assign a variable to the modified custom properties. For example:
`$customProperty = '<CustomProperties...</CustomProperties>'.`
6. Run `$gcpServiceAccount = "<ENTER YOUR SERVICE ACCOUNT EMAIL HERE>"`
`.`
7. Run `$gcpPrivateKey = "<ENTER YOUR SERVICE ACCOUNT PRIVATE KEY HERE AFTER REMOVING ALL INSTANCES OF \n >"`.
8. Run `$securePassword = ConvertTo-SecureString $gcpPrivateKey -AsPlainText -Force`.
9. Run the following to update an existing host connection:

```

1 Set-Item -PassThru -Path @('XDHyp:\\Connections\\<ENTER YOUR
  CONNECTION NAME HERE>') -SecurePassword $securePassword -
  UserName $gcpServiceAccount -CustomProperties $customProperty
2 <!--NeedCopy-->

```

Required GCP permissions

This section has the complete list of GCP permissions. Use the complete set of permissions as given in the section for the functionality to work correctly.

Note:

GCP is introducing changes to Cloud Build Services's default behavior and use of service accounts after April 29, 2024. For more information, see [Cloud Build Service Account Change](#). Your existing Google projects with Cloud Build API enabled before April 29, 2024 are not affected by this change. However, if you want to have existing Cloud Build Service behavior after April 29, you can create or apply the organization policy to disable the constraint enforcement before you enable the API. If you set the new organization policy, you can still follow the existing permissions in this section and the items that are marked **Before Cloud Build Service Account Change**. If not, then follow the existing permissions and items that are marked **After Cloud Build Service Account Change**.

Creating a host connection

- Minimum permissions required for Citrix Cloud Service Account in Provisioning project:

```
1 compute.instanceTemplates.list
2 compute.instances.list
3 compute.networks.list
4 compute.projects.get
5 compute.regions.list
6 compute.subnetworks.list
7 compute.zones.list
8 resourcemanager.projects.get
9 <!--NeedCopy-->
```

The following Google defined roles have the permissions as listed above:

- Compute Admin
- Cloud Datastore User
- Additional permissions required for Shared VPC for Citrix Cloud Service Account in Shared VPC project:

```
1 compute.networks.list
2 compute.subnetworks.list
3 resourcemanager.projects.get
4 <!--NeedCopy-->
```

The following Google defined roles have the permissions as listed above:

- Compute Network User

Power management of VMs

Minimum permissions required for Citrix Cloud Service Account in Provisioning project in case of power managed only catalogs:

```
1 compute.instanceTemplates.list
2 compute.instances.list
3 compute.instances.get
4 compute.instances.reset
5 compute.instances.resume
6 compute.instances.start
7 compute.instances.stop
8 compute.instances.suspend
9 compute.networks.list
10 compute.projects.get
11 compute.regions.list
12 compute.subnetworks.list
13 compute.zones.list
14 resourcemanager.projects.get
15 compute.zoneOperations.get
16 <!--NeedCopy-->
```

The following Google defined roles have the permissions as listed above:

- Compute Admin
- Cloud Datastore User

Creating, updating, or deleting VMs

- Minimum permissions required for Citrix Cloud Service Account in Provisioning project:

```
1  cloudbuild.builds.create
2  cloudbuild.builds.get
3  cloudbuild.builds.list
4  compute.acceleratorTypes.list
5  compute.diskTypes.get
6  compute.diskTypes.list
7  compute.disks.create
8  compute.disks.createSnapshot
9  compute.disks.delete
10 compute.disks.get
11 compute.disks.list
12 compute.disks.setLabels
13 compute.disks.use
14 compute.disks.useReadOnly
15 compute.firewalls.create
16 compute.firewalls.delete
17 compute.firewalls.list
18 compute.globalOperations.get
19 compute.images.create
20 compute.images.delete
21 compute.images.get
22 compute.images.list
23 compute.images.setLabels
24 compute.images.useReadOnly
25 compute.instanceTemplates.create
26 compute.instanceTemplates.delete
27 compute.instanceTemplates.get
28 compute.instanceTemplates.list
29 compute.instanceTemplates.useReadOnly
30 compute.instances.attachDisk
31 compute.instances.create
32 compute.instances.delete
33 compute.instances.detachDisk
34 compute.instances.get
35 compute.instances.list
36 compute.instances.reset
37 compute.instances.resume
38 compute.instances.setDeletionProtection
39 compute.instances.setLabels
40 compute.instances.setMetadata
41 compute.instances.setServiceAccount
42 compute.instances.setTags
43 compute.instances.start
44 compute.instances.stop
45 compute.instances.suspend
```

```
46 compute.machineTypes.get
47 compute.machineTypes.list
48 compute.networks.list
49 compute.networks.updatePolicy
50 compute.nodeGroups.list
51 compute.nodeTemplates.get
52 compute.projects.get
53 compute.regions.list
54 compute.snapshots.create
55 compute.snapshots.delete
56 compute.snapshots.list
57 compute.snapshots.get
58 compute.snapshots.setLabels
59 compute.snapshots.useReadOnly
60 compute.subnetworks.get
61 compute.subnetworks.list
62 compute.subnetworks.use
63 compute.zoneOperations.get
64 compute.zoneOperations.list
65 compute.zones.get
66 compute.zones.list
67 iam.serviceAccounts.actAs
68 resourcemanager.projects.get
69 storage.buckets.create
70 storage.buckets.delete
71 storage.buckets.get
72 storage.buckets.list
73 storage.buckets.update
74 storage.objects.create
75 storage.objects.delete
76 storage.objects.get
77 storage.objects.list
78 compute.networks.get
79 compute.resourcePolicies.use
80
81 <!--NeedCopy-->
```

The following Google defined roles have the permissions as listed above:

- Compute Admin
 - Storage Admin
 - Cloud Build Editor
 - Service Account User
 - Cloud Datastore User
- Additional permissions required for Shared VPC for Citrix Cloud Service Account in Shared VPC project to create a hosting unit using VPC and subnetwork from Shared VPC project:

```
1 compute.firewalls.list
2 compute.networks.list
3 compute.projects.get
4 compute.regions.list
```

```
5 compute.subnetworks.get
6 compute.subnetworks.list
7 compute.subnetworks.use
8 compute.zones.list
9 resourcemanager.projects.get
10 <!--NeedCopy-->
```

The following Google defined roles have the permissions as listed above:

- Compute Network User
- Cloud Datastore User
- (Before Cloud Build Service Account Change): Minimum permissions required for Cloud Build Service Account in Provisioning project required by Google Cloud Build service when downloading preparation instruction disk to MCS:
- (After Cloud Build Service Account Change): Minimum permissions required for Cloud Compute Service Account in Provisioning project required by Google Cloud Compute service when downloading preparation instruction disk to MCS:

```
1 compute.disks.create
2 compute.disks.delete
3 compute.disks.get
4 compute.disks.list
5 compute.disks.setLabels
6 compute.disks.use
7 compute.disks.useReadOnly
8 compute.images.get
9 compute.images.list
10 compute.images.useReadOnly
11 compute.instances.create
12 compute.instances.delete
13 compute.instances.get
14 compute.instances.getSerialPortOutput
15 compute.instances.list
16 compute.instances.setLabels
17 compute.instances.setMetadata
18 compute.instances.setServiceAccount
19 compute.machineTypes.list
20 compute.networks.get
21 compute.networks.list
22 compute.projects.get
23 compute.subnetworks.list
24 compute.subnetworks.use
25 compute.subnetworks.useExternalIp
26 compute.zoneOperations.get
27 compute.zones.list
28 iam.serviceAccounts.actAs
29 logging.logEntries.create
30 pubsub.topics.publish
31 resourcemanager.projects.get
32 source.repos.get
```

```
33 source.repos.list
34 storage.buckets.create
35 storage.buckets.get
36 storage.buckets.list
37 storage.objects.create
38 storage.objects.delete
39 storage.objects.get
40 storage.objects.list
41 <!--NeedCopy-->
```

The following Google defined roles have the permissions as listed above:

- Cloud Build Service Account (After Cloud Build Service Account Change, it is Cloud Compute Service Account)
 - Compute Instance Admin
 - Service Account User
- Minimum permissions required for Cloud Compute Service Account in Provisioning project required by Google Cloud Build service when downloading preparation instruction disk to MCS:

```
1  resourcemanager.projects.get
2  storage.objects.create
3  storage.objects.get
4  storage.objects.list
5  <!--NeedCopy-->
```

The following Google defined roles have the permissions as listed above:

- Compute Network User
 - Storage Account User
 - Cloud Datastore User
- (Before Cloud Build Service Account Change): Additional permissions required for Shared VPC for Cloud Build Service Account in Provisioning project required by Google Cloud Build service when downloading preparation instruction disk to MCS:
 - (After Cloud Build Service Account Change): Additional permissions required for Shared VPC for Cloud Compute Service Account in Provisioning project required by Google Cloud Compute service when downloading preparation instruction disk to MCS:

```
1  compute.firewalls.list
2  compute.networks.list
3  compute.subnetworks.list
4  compute.subnetworks.use
5  resourcemanager.projects.get
6  <!--NeedCopy-->
```

The following Google defined roles have the permissions as listed above:

- Compute Network User

- Storage Account User
- Cloud Datastore User
- Additional permissions required for Cloud Key Management Service (KMS) for Citrix Cloud Service Account in Provisioning project:

```
1  cloudkms.cryptoKeys.get
2  cloudkms.cryptoKeys.list
3  cloudkms.keyRings.get
4  cloudkms.keyRings.list
5  <!--NeedCopy-->
```

The following Google defined roles have the permissions as listed above:

- Compute KMS Viewer

General permissions

Following are the permissions for Citrix Cloud Service Account in Provisioning project for all features supported in MCS. These permissions provide the best compatibility going forward:

```
1  resourceManager.projects.get
2  cloudbuild.builds.create
3  cloudbuild.builds.get
4  cloudbuild.builds.list
5  compute.acceleratorTypes.list
6  compute.diskTypes.get
7  compute.diskTypes.list
8  compute.disks.create
9  compute.disks.createSnapshot
10 compute.disks.delete
11 compute.disks.get
12 compute.disks.setLabels
13 compute.disks.use
14 compute.disks.useReadOnly
15 compute.firewalls.create
16 compute.firewalls.delete
17 compute.firewalls.list
18 compute.globalOperations.get
19 compute.images.create
20 compute.images.delete
21 compute.images.get
22 compute.images.list
23 compute.images.setLabels
24 compute.images.useReadOnly
25 compute.instanceTemplates.create
26 compute.instanceTemplates.delete
27 compute.instanceTemplates.get
28 compute.instanceTemplates.list
29 compute.instanceTemplates.useReadOnly
30 compute.instances.attachDisk
```



```
31 compute.instances.create
32 compute.instances.delete
33 compute.instances.detachDisk
34 compute.instances.get
35 compute.instances.list
36 compute.instances.reset
37 compute.instances.resume
38 compute.instances.setDeletionProtection
39 compute.instances.setLabels
40 compute.instances.setMetadata
41 compute.instances.setTags
42 compute.instances.start
43 compute.instances.stop
44 compute.instances.suspend
45 compute.instances.update
46 compute.instances.updateAccessConfig
47 compute.instances.updateDisplayDevice
48 compute.instances.updateSecurity
49 compute.instances.updateShieldedInstanceConfig
50 compute.instances.updateShieldedVmConfig
51 compute.machineTypes.get
52 compute.machineTypes.list
53 compute.networks.list
54 compute.networks.updatePolicy
55 compute.nodeGroups.list
56 compute.nodeTemplates.get
57 compute.projects.get
58 compute.regions.list
59 compute.snapshots.create
60 compute.snapshots.delete
61 compute.snapshots.list
62 compute.snapshots.get
63 compute.snapshots.setLabels
64 compute.snapshots.useReadOnly
65 compute.subnetworks.get
66 compute.subnetworks.list
67 compute.subnetworks.use
68 compute.subnetworks.useExternalIp
69 compute.zoneOperations.get
70 compute.zoneOperations.list
71 compute.zones.get
72 compute.zones.list
73 resourcemanager.projects.get
74 storage.buckets.create
75 storage.buckets.delete
76 storage.buckets.get
77 storage.buckets.list
78 storage.buckets.update
79 storage.objects.create
80 storage.objects.delete
81 storage.objects.get
82 storage.objects.list
83 cloudkms.cryptoKeys.get
```

```
84 cloudkms.cryptoKeys.list
85 cloudkms.keyRings.get
86 cloudkms.keyRings.list
87 compute.disks.list
88 compute.instances.setServiceAccount
89 compute.networks.get
90 compute.networks.use
91 compute.networks.useExternalIp
92 iam.serviceAccounts.actAs
93 compute.resourcePolicies.use
94 <!--NeedCopy-->
```

Where to go next

- If you're in the initial deployment process, see [Create machine catalogs](#)
- For Google Cloud Platform (GCP) specific information, see [Create a Google Cloud Platform catalog](#)

More information

- [Connections and resources](#)
- [Create machine catalogs](#)

Connection to HPE Moonshot

April 16, 2024

[Create and manage connections and resources](#) describes the wizards that create a connection. The following information covers details specific to HPE Moonshot.

Note:

Before creating a connection to HPE Moonshot, you need to first finish setting up your HPE account. See [HPE Moonshot virtualization environments](#).

Create a connection

You can create a connection to HPE Moonshot using:

- Web Studio
- PowerShell commands

Create a connection using Web Studio

1. In the **Add Connection and Resources** page, select the **HPE Moonshot** as the connection type.
2. Enter the connection address of your Moonshot iLO Chassis Manager. You can use an IP address, host name, or FQDN for the address.
3. Enter your chassis administrative credentials and a friendly connection name.

Connection setup stops when either of the situations occurs:

- Citrix Virtual Apps and Desktops receives a public CA-signed certificate with errors: An error message appears. Follow the on-screen instructions to fix the issue. Otherwise, you can't proceed with connection creation.
- Citrix Virtual Apps and Desktops receives a private CA-signed certificate. A warning page appears. Compare the received thumbprint with the server's for the certificate validity. If it's valid, select **Trust certificate** and click **OK** to proceed with connection creation. Citrix Virtual Apps and Desktops will then trust the certificate and store the thumbprint for future validation.

Create a connection using PowerShell commands

When you create a connection using PowerShell command, provide the following information:

- IP: HPE Server IP Address
- Username: HPE username
- Password: HPE password

For example:

```
1 New-Item -ConnectionType "Custom" -HypervisorAddress $IP -Metadata @{
2   "Citrix_Orchestration_Hypervisor_Secret_Allow_Edit"="false" }
3   -Path @("XDHyp:\Connections\$connectionName") -Persist -PluginId "
   HPMoonshotFactory" -Scope @() -SecurePassword $Password -UserName
   $UserName -sslthumbprint $SslThumbprint New-
   BrokerHypervisorConnection -HypHypervisorConnectionUid
   $HypervisorConnectionID
4 <!--NeedCopy-->
```

Note:

The `sslthumbprint` parameter is required for only Private CA-signed certificates.

Certificate and thumbprint validation

For creating a successful connection to **HPE Moonshot**, the certificate must not have errors and the thumbprint must have a correct value. Following are the use cases related to the certificate and thumbprint validation:

- Public CA-signed certificate has errors. The connection is not created successfully. See the error details and resolve the issue.
- Public CA-signed certificate without errors. The connection is created successfully, and the `SslThumbprints` value is **Null**.
- Private CA-signed certificate without errors and a `sslthumbprint` value. The connection is created successfully with a correct `SslThumbprints` value.
- Private CA-signed Certificate with an incorrect thumbprint value. The connection is not created successfully.
- Private CA-signed Certificate without errors. The connection is created successfully. The `SSLThumbprints` is **Null** when creating the connection. The `SSLThumbprints` value is updated to a value by the site service.

Manage connections

This section details how you can manage connections:

- Fix certificate issues using the Web Studio
- Update thumbprint value using PowerShell command

Fix certificate issues

Citrix Virtual Apps and Desktops blocks an HPE Moonshot connection when certificate issues arise, preventing you from delivering and managing workloads on associated HPE Moonshot nodes. You'll see an error icon next to the connection in the **Host connections** list. See the following table for specific issues and solutions.

Issue	Solution
A certificate error occurs to the public CA-signed certificate	Click the connection and select the Troubleshoot tab. View the error details and resolve the issue.
The received certificate is private CA-signed or expired.	<p>Edit the host connection to update the certificate thumbprint. Details steps</p> <ol style="list-style-type: none"> 1. Select the connection and click Edit Connection. 1. On the Connection Properties page, click Edit settings.

Issue	Solution
	<ol style="list-style-type: none">1. Enter the password to connect to the HPE Moonshot chassis, and then click Save.1. On the Warning page that appears, compare the received thumbprint with the server's for certificate validity.1. If they are the same, select Trust certificate and then click OK.

Update thumbprint value

After creating the connection, you can update the thumbprint value of a connection using the `Set-Item` PowerShell command. For example, run the following commands:

1. Get the connection details of a connection. For example:

```
1 Get-Item -LiteralPath xdhyp:\connections\SinMoonshot-101
2 <!--NeedCopy-->
```

2. Update the thumbprint value. For example:

```
1 Set-Item -LiteralPath xdhyp:\connections\SinMoonshot-101 -Username
  Administrator -SslThumbprint
  xxxxxxxxxxxx12AD048480631BB7AB10D69xxxxx
2 <!--NeedCopy-->
```

3. Check the updated thumbprint value. For example:

```
1 Get-Item -LiteralPath xdhyp:\connections\SinMoonshot-101
2 <!--NeedCopy-->
```

Note:

The update fails if you provide an incorrect thumbprint value in the `Set-Item` command.

Where to go next

- If you're in the initial deployment process, see [Create machine catalogs](#)
- For AWS specific information, see [Create an HPE Moonshot machine catalog](#)

More information

- [Connections and resources](#)
- [Create machine catalogs](#)

Connection to Microsoft Azure

November 9, 2023

[Create and manage connections and resources](#) describes the wizards that create a connection. The following information covers details specific to Azure Resource Manager cloud environments.

Note:

Before creating a connection to Microsoft Azure, you must finish setting up your Azure account as a resource location. See [Microsoft Azure Resource Manager cloud environments](#).

Create service principals and connections

Before creating connections, you must set up service principals that connections use to access Azure resources. You can create a connection in two ways:

- Create a service principal and a connection together using Web Studio
- Create a connection using a previously created service principal

This section shows you how to complete these tasks:

- [Create a service principal and connection using Web Studio](#)
- [Create a service principal using PowerShell](#)
- [Get the application secret in Azure](#)
- [Create a connection using an existing service principal](#)

Considerations

- Citrix recommends using Service Principal with contributor role. However, see Minimum permissions section to get the list of minimum permissions.
- When creating the first connection, Azure prompts you to grant it the necessary permissions. For future connections you must still authenticate, but Azure remembers your previous consent and does not display the prompt again.
- Accounts used for authentication must be a co-administrator of the subscription.

- The account used for authentication must be a member of the subscription's directory. There are two types of accounts to be aware of: 'Work or School' and 'personal Microsoft account.' See [CTX219211](#) for details.
- While you can use an existing Microsoft account by adding it as a member of the subscription's directory, there can be complications if the user was previously granted guest access to one of the directory's resources. In this case, they might have a placeholder entry in the directory that does not grant them the necessary permissions, and an error is returned.

Rectify this by removing the resources from the directory and add them back explicitly. However, exercise this option carefully, because it has unintended effects for other resources that the account can access.

- There is a known issue where certain accounts are detected as directory guests when they are actually members. Configurations like this typically occurs with older established directory accounts. Workaround: add an account to the directory, which takes the proper membership value.
- Resource groups are simply containers for resources, and they can contain resources from regions other than their own region. This can potentially be confusing if you expect resources displayed in a resource group's region to be available.
- Ensure that your network and subnet are large enough to host the number of machines you require. This requires some foresight, but Microsoft helps you specify the right values, with guidance about the address space capacity.

Create a service principal and connection using Web Studio

Important:

This feature is not yet available for Azure China subscriptions.

With Web Studio, you can create both a service principal and a connection in a single workflow. Service principals give connections access to Azure resources. When you authenticate to Azure to create a service principal, an application is registered in Azure. A secret key (called client secret or application secret) is created for the registered application. The registered application (a connection in this case) uses the client secret to authenticate to Azure AD.

Before you start, make sure that you've met these prerequisites:

- You have a user account in your subscription's Azure Active Directory tenant.
- The Azure AD user account is also a co-administrator for the Azure subscription that you want to use for provisioning resources.

- You have global administrator, application administrator, or application developer permissions for authentication. These permissions can be revoked after you create host connection. For more information about roles, see [Azure AD built-in roles](#).

Use the **Add Connection and Resources** wizard to create a service principal and a connection together:

1. On the **Connection** page, select **Create a new connection**, the **Microsoft Azure** connection type, and your Azure environment.
2. Select which tools to use to create the virtual machines and then select **Next**.
3. On the **Connection Details** page, enter your Azure subscription ID and a name for the connection. After you enter the subscription ID, the **Create new** button is enabled.

Note:

The connection name can contain 1–64 characters, and cannot contain only blank spaces nor the characters `\ / ; : # . * ? = < > | [] { } " ' () ' .`

4. Select **Create new** and then enter the Azure Active Directory account user name and password.
5. Select **Sign in**.
6. Select **Accept** to give Citrix Virtual Apps and Desktops the listed permissions. Citrix Virtual Apps and Desktops creates a service principal that allows it to manage Azure resources on behalf of the specified user.
7. After you select **Accept**, you return to the **Connection** page in the wizard.

Note:

After you successfully authenticate to Azure, the **Create new** and **Use existing** buttons disappear. The **Connection successful** text appears, with a green check mark, indicating the successful connection to your Azure subscription.

8. On the **Connection Details** page, select **Next**.

Note:

You cannot proceed to the next page until you successfully authenticate to Azure and consent to giving the required permissions.

9. Configure resources for the connection. Resources comprise the region and the network.
 - On the **Region** page, select a region.
 - On the **Network** page, do the following:

- Type a 1–64 character resource name to help identify the region and network combination. A resource name cannot contain only blank spaces nor the characters `\ / ; : # . * ? = < > | [] { } " ' () ' .`
- Select a virtual network/resource group pair. (If you have more than one virtual network with the same name, pairing the network name with the resource group provides unique combinations.) If the region you selected on the previous page does not have any virtual networks, return to that page and select a region that has virtual networks.

10. On the **Summary** page, view a summary of settings and select **Finish** to complete your setup.

View the application ID After you create a connection, you can view the application ID that the connection uses to access Azure resources.

In the **Add Connection and Resources** list, select the connection to view the details. The **Details** tab shows the Application ID.

Create a service principal using PowerShell

To create a service principal using PowerShell, connect to your Azure Resource Manager subscription and use the PowerShell cmdlets provided in the following sections.

Make sure that you have these items ready:

- **SubscriptionId:** Azure Resource Manager `SubscriptionID` for the subscription where you want to provision VDAs.
- **ActiveDirectoryID:** Tenant ID of the application that you registered with Azure AD.
- **ApplicationName:** Name for the application to be created in Azure AD.

Detailed steps are as follows:

Connect to your Azure Resource Manager subscription.

```
1 `Connect-AzAccount`
```

1. Select the Azure Resource Manager subscription where you want to create the service principal.

```
Get-AzSubscription -SubscriptionId $subscriptionId | Select-  
AzSubscription
```

2. Create the application in your AD tenant.

```
$AzureADApplication = New-AzADApplication -DisplayName $ApplicationName
```

3. Create a service principal.

```
New-AzADServicePrincipal -ApplicationId $AzureADApplication.AppId
```

4. Assign a role to the service principal.

```
New-AzRoleAssignment -RoleDefinitionName Contributor -ServicePrincipalName  
$AzureADApplication.AppId -scope /subscriptions/$SubscriptionId
```

5. From the output window of the PowerShell console, note the ApplicationId. You provide that ID when creating the host connection.

Get the application secret in Azure

To create a connection using an existing service principal, you must first get the application ID and secret of the service principal in the Azure portal.

Detailed steps are as follows:

1. Get the **Application ID** from the Web Studio or using PowerShell.
2. Sign in to the Azure portal.
3. In Azure, select **Azure Active Directory**.
4. From **App registrations** in Azure AD, select your application.
5. Go to **Certificates & secrets**.
6. Click **Client secrets**.

Create a connection using an existing service principal

If you already have a service principal, you can use it to create a connection using Web Studio.

Make sure you have these items ready:

- SubscriptionId
- ActiveDirectoryID (tenant ID)
- Application ID
- Application secret

For more information, see [Get the application secret](#).

- Secret expiration date

Detailed steps are as follows:

In the **Add Connection and Resources** wizard:

1. On the **Connection** page, select **Create a new connection**, the **Microsoft Azure** connection type, and your Azure environment.
2. Select which tools to use to create the virtual machines and then select **Next**.
3. On the **Connection Details** page, enter your Azure subscription ID and a name for the connection.

Note:

The connection name can contain 1–64 characters, and cannot contain only blank spaces nor the characters `\ / ; : # . * ? = < > | [] { } " ' () ' .`

4. Select **Use existing**. In the **Existing Service Principal Details** window, enter the following settings for the existing service principal. After you enter the details, the **Save** button is enabled. Select **Save**. You cannot progress beyond this page until you provide valid details.
 - **Subscription ID**. Enter your Azure subscription ID. To obtain your subscription ID, sign in to the Azure portal and navigate to **Subscriptions > Overview**.
 - **Active Directory ID** (tenant ID). Enter the Directory (tenant) ID of the application that you registered with Azure AD.
 - **Application ID**. Enter the Application (client) ID of the application that you registered with Azure AD.
 - **Application secret**. Create a secret key (client secret). The registered application uses the key to authenticate to Azure AD. We recommend that you change keys regularly for security purposes. Be sure to save the key because you cannot retrieve the key later.
 - **Secret expiration date**. Enter the date after which the application secret expires. You receive an alert on the console before the secret key expires. However, if the secret key expires, you receive errors.

Note:

For security purposes, the expiration period cannot be more than two years from now.

- **Authentication URL**. This field is automatically populated and is not editable.
- **Management URL**. This field is automatically populated and is not editable.
- **Storage suffix**. This field is automatically populated and is not editable.

Access to the following endpoints is required for creating an MCS catalog in Azure. Access to these endpoints optimizes connectivity between your network and the Azure portal and its services.

- Authentication URL: <https://login.microsoftonline.com/>
 - Management URL: <https://management.azure.com/>. This is a request URL for Azure Resource Manager provider APIs. The endpoint for management depends on the environment. For example, for Azure Global, it is <https://management.azure.com/>, and for Azure US Government, it is <https://management.usgovcloudapi.net/>.
 - Storage suffix: https://*.core.windows.net/. This (*) is a wildcard character for storage suffix. For example, <https://demo.table.core.windows.net/>.
5. After selecting **Save**, you return to the **Connection Details** page. Select **Next** to continue to the next page.
 6. Configure resources for the connection. Resources comprise the region and the network.
 - On the **Region** page, select a region.
 - On the **Network** page, do the following:
 - Type a 1–64 character resource name to help identify the region and network combination. A resource name cannot contain only blank spaces nor the characters `\ / ; : # . * ? = < > | [] { } " ' () ' .`
 - Select a virtual network/resource group pair. (If you have more than one virtual network with the same name, pairing the network name with the resource group provides unique combinations.) If the region you selected on the previous page does not have any virtual networks, return to that page and select a region that has virtual networks.
 7. On the **Summary** page, view a summary of settings and select **Finish** to complete your setup.

Manage service principals and connections

This section details how you can manage service principals and connections:

- Configure Azure throttling settings
- Enable image sharing in Azure
- Add shared tenants to a connection using Full Configuration
- Implement image sharing using PowerShell
- Manage the application secret and secret expiration date

Configure Azure throttling settings

Azure Resource Manager throttles requests for subscriptions and tenants, routing traffic based on defined limits, tailored to the specific needs of the provider. See [Throttling Resource Manager requests](#)

on the Microsoft site for more information. Limits exist for subscriptions and tenants, where managing many machines can become problematic. For example, a subscription containing many machines might experience performance issues related to power operations.

Tip:

For more information, see [Improving Azure performance with Machine Creation Services](#).

To help mitigate these issues, you can remove MCS internal throttling to use more of the available request quota from Azure.

We recommend the following optimal settings when powering VMs on or off in large subscriptions, for example, those containing 1,000 VMs:

- Absolute simultaneous operations: 500
- Maximum new operations per minute: 2000
- Max concurrency of operations: 500

Use Web Studio to configure Azure operations for a given Azure connection:

1. In Web Studio, select **Hosting** in the left pane.
2. Select the connection.
3. In the **Edit Connection** wizard, select **Advanced**.
4. On the **Advanced** page, use the configuration options to specify the number of simultaneous actions and maximum new actions per minute, and any additional connection options.

Edit Connection
Azure-08

Connection Properties

Advanced

Scopes

Advanced

Use these settings to specify a maximum number of simultaneous actions (or concurrent machines) per hosting connection. For simultaneous actions, specify both settings. The lower value overrides the higher value. [Learn more](#)

	Absolute	Percentage (%)
Simultaneous actions (all types): ?	<input type="text" value="500"/>	<input type="text" value="100"/>
Maximum new actions per minute:	<input type="text" value="2000"/>	

Connection options:

Use this setting only when Citrix Technical Support or the product documentation makes the recommendation.

Save Apply Cancel

MCS supports 500 maximum concurrent operations by default. Alternatively, you can use the Remote PowerShell SDK to set the maximum number of concurrent operations.

Use the **PowerShell** property, `MaximumConcurrentProvisioningOperations`, to specify the maximum number of concurrent Azure provisioning operations. When using this property, consider:

- Default value of `MaximumConcurrentProvisioningOperations` is 500.
- Configure the `MaximumConcurrentProvisioningOperations` parameter using the PowerShell command `Set-Item`.

Enable image sharing in Azure

When creating or updating machine catalogs, you can select shared images from different Azure tenants and subscriptions (shared through the Azure Compute Gallery). To enable image sharing within or across tenants, you must make the necessary settings in Azure:

- Share images within a tenant (across subscriptions)
- Share images across tenants

Share images within a tenant (across subscriptions) To select an image in Azure Compute Gallery that belongs to a different subscription, the image must be shared with the service principal (SPN) of that subscription.

For example, if there is a service principal (SPN 1), which is configured in Studio as:

Service principal: SPN 1

Subscription: subscription 1

Tenant: tenant 1

The image is in different subscription, which is configured in Studio as:

Subscription: subscription 2

Tenant: tenant 1

If you want to share the image in subscription 2 with subscription 1 (SPN 1), go to subscription 2, and share the resource group with SPN1.

The image must be shared with another SPN using Azure role-based access control (RBAC). Azure RBAC is the authorization system used to manage access to Azure resources. For more information on Azure RBAC, see the Microsoft document [What is Azure role-based access control \(Azure RBAC\)](#). To grant access, you assign roles to service principals at resource group scope with Contributor role. To assign Azure roles, you must have `Microsoft.Authorization/roleAssignments/write` permission, such as User Access Administrator or Owner. For more information on sharing images with another SPN, see the Microsoft document [Assign Azure roles using the Azure portal](#).

For information on selecting an image from a different subscription using PowerShell commands, Select an image from a different subscription.

Share images across tenants To share images across tenants with Azure Compute Gallery, create an application registration.

For example, if there are two tenants (Tenant 1 and Tenant 2) and you want to share your image gallery with Tenant 1, then:

1. Create an application registration for Tenant 1. For more information, see [Create the app registration](#).
2. Give Tenant 2 access to the application by requesting a sign-in using a browser. Replace `Tenant2 ID` with the tenant ID of Tenant 1. Replace `Application (client) ID` with the application ID of the application registration that you created. When done making the replacements, paste the URL into a browser and follow the sign-in prompts to sign into Tenant 2. For example:

```
1 https://login.microsoftonline.com/<Tenant 2 ID>/oauth2/authorize?  
   client_id=<Application (client) ID>&response_type=code&  
   redirect_uri=https%3A%2F%2Fwww.microsoft.com%2F  
2 <!--NeedCopy-->
```

For more information, see [Give Tenant 2 access](#).

3. Give the application access to the Tenant 2 resource group. Sign in as Tenant 2 and give the application registration access to the resource group which has the gallery image. For more information, see [Authenticate requests across tenants](#).

To create a catalog using an image from a different tenant using PowerShell commands:

1. Update hosting connection custom properties with shared tenant IDs.
2. Select an image from a different tenant.

Add shared tenants to a connection using Full Configuration

When creating or updating machine catalogs in Web Studio, you can select shared images from different Azure tenant and subscriptions (shared through the Azure Compute Gallery). The feature requires that you provide shared tenant and subscription information for associated host connections.

Note:

Make sure you've configured the necessary settings in Azure to enable image sharing across tenants. For more information, see [Share images across tenants](#).

Complete the following steps for a connection:

1. In Web Studio, select **Hosting** in the left pane.
2. Select the connection and then select **Edit Connection** in the action bar.

3. In **Shared Tenants**, do the following:

- Provide the application ID and application secret associated with the subscription of the connection. Citrix Virtual Apps and Desktops uses this information to authenticate to Azure AD.
- Add tenants and subscriptions that share the Azure Compute Gallery with the subscription of the connection. You can add up to 8 shared tenants and 8 subscriptions for each tenant.

4. When you are finished, select **Apply** to apply the changes you made and keep the window open, or select **OK** to apply the changes and close the window.

Implement image sharing using PowerShell

This section guides you through the processes of sharing images using PowerShell:

- Select an image from a different subscription
- Update hosting connection custom properties with shared tenant IDs
- Select an image from a different tenant

Select an image from a different subscription You can select an image in Azure Compute Gallery that belongs to a different shared subscription in the same Azure tenant to create and update MCS catalogs using PowerShell commands.

1. In the hosting unit root folder, Citrix creates a new shared subscription folder called `sharedsubscription`.
2. List all shared subscriptions in a tenant.

```

1 Get-ChildItem -Path "XDhyp:\HostingUnits\azres\sharedsubscription.
  folder"
2 <!--NeedCopy-->

```

3. Select one shared subscription, and then list all shared resource groups of that shared subscription.

```

1 Get-ChildItem -Path "XDhyp:\HostingUnits\azres\image.folder\abc123
  .sharedsubscription"
2 <!--NeedCopy-->

```

4. Select a resource group, and then list all galleries of that resource group.

```

1 Get-ChildItem -Path "XDhyp:\HostingUnits\azres\image.folder\abc123
  .sharedsubscription\ xyz.resourcegroup"
2 <!--NeedCopy-->

```

5. Select a gallery, and then list all image definitions of that gallery.

```

1 Get-ChildItem -Path "XDhyp:\HostingUnits\azres\image.folder\abc123
  .sharedsubscription\xyz.resourcegroup\testgallery.gallery"
2 <!--NeedCopy-->

```

6. Select one image definition, and then list all image versions of that image definition.

```

1 Get-ChildItem -Path "XDhyp:\HostingUnits\azres\image.folder\abc123
  .sharedsubscription\xyz.resourcegroup\sigtestdef.
  imagedefinition"
2 <!--NeedCopy-->

```

7. Create and update an MCS catalog using the following elements:

- Resource group
- Gallery
- Gallery image definition
- Gallery image version

For information on how to create a catalog using the Remote PowerShell SDK, see <https://developer-docs.citrix.com/projects/citrix-virtual-apps-desktops-sdk/en/latest/creating-a-catalog/>.

Update hosting connection custom properties with shared tenant IDs Use `Set-Item` to update the hosting connection custom properties with shared tenant IDs and subscription IDs. Add a property `SharedTenants` in `CustomProperties`. The format of `Shared Tenants` is:

```

1 [{
2   "Tenant": "94367291-119e-457c-bc10-25337231f7bd", "Subscriptions": ["7
  bb42f40-8d7f-4230-a920-be2781f6d5d9"] }
3  ,{

```

```

4   "Tenant": "50e83564-c4e5-4209-b43d-815c45659564", "Subscriptions": ["06
      ab8944-6a88-47ee-a975-43dd491a37d0"] }
5   ]
6   <!--NeedCopy-->

```

For example:

```

1   Set-Item -CustomProperties "<CustomProperties xmlns='http://schemas.
      citrix.com/2014/xd/machinecreation' xmlns:xsi='http://www.w3.org
      /2001/XMLSchema-instance'"
2   <Property xsi:type='StringProperty' Name='SubscriptionId' Value='123' />
3   <Property xsi:type='StringProperty' Name='ManagementEndpoint' Value=
      ='https://management.azure.com/' />
4   <Property xsi:type='StringProperty' Name='AuthenticationAuthority'
      Value='https://login.microsoftonline.com/' />
5   <Property xsi:type='StringProperty' Name='StorageSuffix' Value='core.
      windows.net' />
6   <Property xsi:type='StringProperty' Name='TenantId' Value='123abc' />
7   <Property xsi:type='StringProperty' Name='SharedTenants' Value='{
      {
8     'Tenant':'123abc', 'Subscriptions':['345', '567'] }
9   }' />
10  </CustomProperties>
11  -LiteralPath @("XDHyp:\Connections\azure") -PassThru -UserName "
      advc345" -SecurePassword
12  $psd
13  <!--NeedCopy-->

```

Note:

You can add more than one tenant. Each tenant can have more than one subscription.

Select an image from a different tenant You can select an image in the Azure Compute Gallery that belongs to a different Azure tenant to create and update MCS catalogs using PowerShell commands.

1. In the hosting unit root folder, Citrix creates a new shared subscription folder called `sharedsubscription`.
2. List all shared subscriptions.

```

1   Get-ChildItem XDHyp:\HostingUnits\azres\sharedsubscription.folder
2   <!--NeedCopy-->

```

3. Select one shared subscription, and then list all shared resource groups of that shared subscription.

```

1   Get-ChildItem XDHyp:\HostingUnits\azres\image.folder\abc123.
      sharedsubscription
2   <!--NeedCopy-->

```

4. Select a resource group, and then list all galleries of that resource group.

```
1 Get-ChildItem XDHyp:\HostingUnits\azres\image.folder\abc123.
  sharedsubscription\ xyz.resourcegroup
2 <!--NeedCopy-->
```

5. Select a gallery, and then list all image definitions of that gallery.

```
1 Get-ChildItem XDHyp:\HostingUnits\azres\image.folder\abc123.
  sharedsubscription\xyz.resourcegroup\efg.gallery
2 <!--NeedCopy-->
```

6. Select one image definition, and then list all image versions of that image definition.

```
1 Get-ChildItem XDHyp:\HostingUnits\azres\image.folder\abc123.
  sharedsubscription\xyz.resourcegroup\efg.gallery\hij.
  imagedefinition
2 <!--NeedCopy-->
```

7. Create and update an MCS catalog using the following elements:

- Resource group
- Gallery
- Gallery image definition
- Gallery image version

For information on how to create a catalog using the Remote PowerShell SDK, see <https://developer-docs.citrix.com/projects/citrix-virtual-apps-desktops-sdk/en/latest/creating-a-catalog/>.

Manage the application secret and secret expiration date

Be sure to change the application secret for a connection before the secret expires. You receive an alert on the Web Studio before the secret key expires.

Create an application secret in Azure You can create an application secret for a connection through the Azure portal.

1. Select **Azure Active Directory**.
2. From **App registrations** in Azure AD, select your application.
3. Go to **Certificates & secrets**.
4. Click **Client secrets > New client secret**.
5. Provide a description of the secret and specify a duration. When you're done, select **Add**.

Note:

Be sure to save the client secret because you cannot retrieve it later.

6. Copy the client secret value and the expiration date.
7. In the Web Studio, edit the corresponding connection and replace the content in the **Application secret** and **Secret expiration date** field with the values you copied.

Change the secret expiration date You can use the Web Studio to add or modify the expiration date for the application secret in use.

1. In the **Add Connection and Resources** wizard, right-click a connection, and click **Edit Connection**.
2. On the **Connection Properties** page, click **Secret expiration date** to add or modify the expiration date for the application secret in use.

Required Azure permissions

This section contains the minimum and general permissions required for Azure.

Minimum permissions

Minimum permissions give better security control. However, new features that require additional permissions fail because of using only minimum permissions.

Creating a host connection Add a new host connection using the information obtained from Azure.

```
1 "Microsoft.Network/virtualNetworks/read",
2 "Microsoft.Compute/virtualMachines/read",
3 "Microsoft.Compute/disks/read",
4 <!--NeedCopy-->
```

Power management of VMs Power on or off the machine instances.

```
1 "Microsoft.Compute/virtualMachines/read",
2 "Microsoft.Resources/subscriptions/resourceGroups/read",
3 "Microsoft.Compute/virtualMachines/deallocate/action",
4 "Microsoft.Compute/virtualMachines/start/action",
5 "Microsoft.Compute/virtualMachines/restart/action",
6 <!--NeedCopy-->
```

Creating, updating, or deleting VMs Create a machine catalog, then add, delete, update machines, and delete the machine catalog.

Following is the list of minimum permissions required when the master image is managed disk or snapshots are located in the same region as the hosting connection.

```

1 "Microsoft.Resources/subscriptions/resourceGroups/read",
2 "Microsoft.Resources/deployments/validate/action",
3 "Microsoft.Compute/virtualMachines/read",
4 "Microsoft.Compute/virtualMachines/write",
5 "Microsoft.Compute/virtualMachines/delete",
6 "Microsoft.Compute/virtualMachines/deallocate/action",
7 "Microsoft.Compute/snapshots/read",
8 "Microsoft.Compute/snapshots/write",
9 "Microsoft.Compute/snapshots/delete",
10 "Microsoft.Compute/snapshots/beginGetAccess/action",
11 "Microsoft.Compute/snapshots/endGetAccess/action",
12 "Microsoft.Compute/disks/read",
13 "Microsoft.Compute/disks/write",
14 "Microsoft.Compute/disks/delete",
15 "Microsoft.Compute/disks/beginGetAccess/action",
16 "Microsoft.Compute/disks/endGetAccess/action",
17 "Microsoft.Network/virtualNetworks/read",
18 "Microsoft.Network/virtualNetworks/subnets/join/action",
19 "Microsoft.Network/virtualNetworks/subnets/read",
20 "Microsoft.Network/networkSecurityGroups/read",
21 "Microsoft.Network/networkSecurityGroups/write",
22 "Microsoft.Network/networkSecurityGroups/delete",
23 "Microsoft.Network/networkSecurityGroups/join/action",
24 "Microsoft.Network/networkInterfaces/read",
25 "Microsoft.Network/networkInterfaces/write",
26 "Microsoft.Network/networkInterfaces/delete",
27 "Microsoft.Network/networkInterfaces/join/action",
28 <!--NeedCopy-->

```

You need the following extra permissions based on minimal permissions for the following features:

- If the master image is a VHD in a storage account located in the same region as the hosting connection:

```

1 "Microsoft.Storage/storageAccounts/read",
2 "Microsoft.Storage/storageAccounts/listKeys/action",
3 <!--NeedCopy-->

```

- If the master image is an ImageVersion from the Shared Image Gallery:

```

1 "Microsoft.Compute/galleries/read",
2 "Microsoft.Compute/galleries/images/read",
3 "Microsoft.Compute/galleries/images/versions/read",
4 <!--NeedCopy-->

```

- If the master image is a managed disk, then the snapshots, or VHD is in a region different from

the region of hosting connection:

```
1 "Microsoft.Storage/storageAccounts/read",
2 "Microsoft.Storage/storageAccounts/listKeys/action",
3 "Microsoft.Storage/storageAccounts/write",
4 "Microsoft.Storage/storageAccounts/delete",
5 <!--NeedCopy-->
```

- If you use Citrix-managed resource group:

```
1 "Microsoft.Resources/subscriptions/resourceGroups/write",
2 "Microsoft.Resources/subscriptions/resourceGroups/delete",
3 <!--NeedCopy-->
```

- If you put the master image in Shared Image Gallery:

```
1 "Microsoft.Compute/galleries/write",
2 "Microsoft.Compute/galleries/images/write",
3 "Microsoft.Compute/galleries/images/versions/write",
4 "Microsoft.Compute/galleries/read",
5 "Microsoft.Compute/galleries/images/read",
6 "Microsoft.Compute/galleries/images/versions/read",
7 "Microsoft.Compute/galleries/delete",
8 "Microsoft.Compute/galleries/images/delete",
9 "Microsoft.Compute/galleries/images/versions/delete",
10 <!--NeedCopy-->
```

- If you use Azure dedicated host support:

```
1 "Microsoft.Compute/hostGroups/read",
2 "Microsoft.Compute/hostGroups/write",
3 "Microsoft.Compute/hostGroups/hosts/read",
4 <!--NeedCopy-->
```

- If you use Server Side Encryption (SSE) with Customer Managed Keys (CMK):

```
1 "Microsoft.Compute/diskEncryptionSets/read",
2 <!--NeedCopy-->
```

- If you deploy VMs using ARM templates (machine profile):

```
1 "Microsoft.Resources/deployments/write",
2 "Microsoft.Resources/deployments/operationstatuses/read",
3 "Microsoft.Resources/deployments/read",
4 "Microsoft.Resources/deployments/delete",
5 <!--NeedCopy-->
```

- If you use Azure template spec as a machine profile:

```
1 "Microsoft.Resources/templateSpecs/read",
2 "Microsoft.Resources/templateSpecs/versions/read",
3 <!--NeedCopy-->
```

Creating, updating, and deleting machines with unmanaged disk Following is the list of minimum permissions required when the master image is VHD and use resource group as provided by admin:

```
1 "Microsoft.Resources/subscriptions/resourceGroups/read",
2 "Microsoft.Storage/storageAccounts/delete",
3 "Microsoft.Storage/storageAccounts/listKeys/action",
4 "Microsoft.Storage/storageAccounts/read",
5 "Microsoft.Storage/storageAccounts/write",
6 "Microsoft.Compute/virtualMachines/deallocate/action",
7 "Microsoft.Compute/virtualMachines/delete",
8 "Microsoft.Compute/virtualMachines/read",
9 "Microsoft.Compute/virtualMachines/write",
10 "Microsoft.Resources/deployments/validate/action",
11 "Microsoft.Network/networkInterfaces/delete",
12 "Microsoft.Network/networkInterfaces/join/action",
13 "Microsoft.Network/networkInterfaces/read",
14 "Microsoft.Network/networkInterfaces/write",
15 "Microsoft.Network/networkSecurityGroups/delete",
16 "Microsoft.Network/networkSecurityGroups/join/action",
17 "Microsoft.Network/networkSecurityGroups/read",
18 "Microsoft.Network/networkSecurityGroups/write",
19 "Microsoft.Network/virtualNetworks/subnets/read",
20 "Microsoft.Network/virtualNetworks/read",
21 "Microsoft.Network/virtualNetworks/subnets/join/action"
22 <!--NeedCopy-->
```

General permission

Contributor role has full access to manage all resources. This set of permissions does not block you from getting new features.

The following set of permissions provides the best compatibility going forward although it does include more permissions than needed with the current feature set:

```
1 "Microsoft.Compute/diskEncryptionSets/read",
2 "Microsoft.Compute/disks/beginGetAccess/action",
3 "Microsoft.Compute/disks/delete",
4 "Microsoft.Compute/disks/endGetAccess/action",
5 "Microsoft.Compute/disks/read",
6 "Microsoft.Compute/disks/write",
7 "Microsoft.Compute/galleries/delete",
8 "Microsoft.Compute/galleries/images/delete",
9 "Microsoft.Compute/galleries/images/read",
10 "Microsoft.Compute/galleries/images/versions/delete",
11 "Microsoft.Compute/galleries/images/versions/read",
12 "Microsoft.Compute/galleries/images/versions/write",
13 "Microsoft.Compute/galleries/images/write",
14 "Microsoft.Compute/galleries/read",
15 "Microsoft.Compute/galleries/write",
```



```
16 "Microsoft.Compute/hostGroups/hosts/read",
17 "Microsoft.Compute/hostGroups/read",
18 "Microsoft.Compute/hostGroups/write",
19 "Microsoft.Compute/snapshots/beginGetAccess/action",
20 "Microsoft.Compute/snapshots/delete",
21 "Microsoft.Compute/snapshots/endGetAccess/action",
22 "Microsoft.Compute/snapshots/read",
23 "Microsoft.Compute/snapshots/write",
24 "Microsoft.Compute/virtualMachines/deallocate/action",
25 "Microsoft.Compute/virtualMachines/delete",
26 "Microsoft.Compute/virtualMachines/read",
27 "Microsoft.Compute/virtualMachines/restart/action",
28 "Microsoft.Compute/virtualMachines/start/action",
29 "Microsoft.Compute/virtualMachines/write",
30 "Microsoft.Network/networkInterfaces/delete",
31 "Microsoft.Network/networkInterfaces/join/action",
32 "Microsoft.Network/networkInterfaces/read",
33 "Microsoft.Network/networkInterfaces/write",
34 "Microsoft.Network/networkSecurityGroups/delete",
35 "Microsoft.Network/networkSecurityGroups/join/action",
36 "Microsoft.Network/networkSecurityGroups/read",
37 "Microsoft.Network/networkSecurityGroups/write",
38 "Microsoft.Network/virtualNetworks/subnets/read",
39 "Microsoft.Network/virtualNetworks/read",
40 "Microsoft.Network/virtualNetworks/subnets/join/action",
41 "Microsoft.Resources/deployments/operationstatuses/read",
42 "Microsoft.Resources/deployments/read",
43 "Microsoft.Resources/deployments/validate/action",
44 "Microsoft.Resources/deployments/write",
45 "Microsoft.Resources/deployments/delete",
46 "Microsoft.Resources/subscriptions/resourceGroups/read",
47 "Microsoft.Resources/subscriptions/resourceGroups/write",
48 "Microsoft.Resources/subscriptions/resourceGroups/delete",
49 "Microsoft.Storage/storageAccounts/delete",
50 "Microsoft.Storage/storageAccounts/listKeys/action",
51 "Microsoft.Storage/storageAccounts/read",
52 "Microsoft.Storage/storageAccounts/write",
53 "Microsoft.Resources/templateSpecs/read",
54 "Microsoft.Resources/templateSpecs/versions/read",
55 <!--NeedCopy-->
```

Where to go next

- If you're in the initial deployment process, see [Create machine catalogs](#)
- For Azure-specific information, see [Create a Microsoft Azure catalog](#)

More information

- [Connections and resources](#)

- [Create machine catalogs](#)

Connection to Microsoft System Center Virtual Machine Manager

June 27, 2023

[Create and manage connections and resources](#) describes the wizards that create a connection. The following information covers details specific to Microsoft System Center Virtual Machine Manager (VMM).

Note:

Before creating a connection to VMM, you need to first finish setting up your VMM account as a resource location. See [Microsoft System Center Virtual Machine Manager virtualization environments](#).

Create a connection

If you used MCS to provision VMs, do the following in the connection creation wizard:

- Enter the address as a fully qualified domain name of the host server.
- Enter credentials for the administrator account that you set up earlier. This account must have permission to create new VMs.
- In the Host Details dialog box, select the cluster or standalone host to use when creating VMs.

Important

Browse for a cluster or standalone host even if you are using a single Hyper-V host deployment.

Where to go next

- If you're in the initial deployment process, see [Create machine catalogs](#)
- For creating machine catalogs with MCS on SMB 3 file share, see [Create a Microsoft System Center Virtual Machine Manager catalog](#)

More information

- [Connections and resources](#)
- [Create machine catalogs](#)

Connection to Nutanix

December 22, 2023

[Create and manage connections and resources](#) describes the wizards that create a connection. The following information covers details specific to Nutanix.

Note:

Before creating a connection to Nutanix, you need to first finish setting up your Nutanix account as a resource location. See [Nutanix virtualization environments](#).

Create a connection to Nutanix

The following information is a supplement to the guidance in [Connections and resources](#). To create a Nutanix connection, follow the general guidance in that article, minding the details specific to Nutanix.

In the **Add Connection and Resources** wizard, select the Nutanix connection type on the **Connection** page, and then specify the address and credentials, plus a name for the connection. On the **Network** page, select a network for the hosting unit.

The following connection types are available for selection: **Nutanix AHV**, **Nutanix AHV DRaaS**, and **Nutanix AHV PC**.

- For **Nutanix AHV**, specify the Prism Element (PE) cluster address and credentials.
- For **Nutanix AHV PC**, specify the Prism Central (PC) address and credentials.

Note:

Currently, the connection type Nutanix AHV PC is only used for creating connection to Nutanix Cloud Cluster (NC2) on Azure. Also, a machine catalog can only be hosted on a single cluster in a NC2 on Azure connection.

- For **Nutanix AHV DRaaS**, specify the DRaaS tenant address and username. Import your private and public Nutanix DRaaS credential files (.pem).

Tip:

If you deploy machines using Nutanix AHV (Prism Element) as the resource, select the container where the VM's disk resides.

Where to go next

- If you're in the initial deployment process, see [Create machine catalogs](#)
- For Nutanix specific information, see [Create a Nutanix catalog](#)

More information

- [Connections and resources](#)
- [Create machine catalogs](#)

Connection to Nutanix cloud and partner solutions

June 27, 2023

[Create and manage connections and resources](#) describes the wizards that create a connection. The following information covers details specific to Nutanix cloud and partner solutions.

Citrix Virtual Apps and Desktops supports the following Nutanix cloud and partner solution:

- Nutanix Cloud Clusters on AWS

Note:

Before creating a connection to Nutanix cloud and partner solution, you need to first finish setting up your respective account as a resource location. See [Nutanix cloud and partner solutions](#).

Connect to Nutanix Prism

After you create a Nutanix cluster, connect to Nutanix Prism.

To connect to Nutanix Prism:

1. Create a bastion VM in the 10.0.129.0/24 subnet.
2. RDP into the bastion VM, go to the URL of the **Prism Element** you copied in the previous section.
3. Log in using the default credentials: `admin:nutanix/4u`. Remember to change the password.

Create a VM on the Nutanix Cluster

After connecting to **Nutanix Prism**, create [VMs on the Nutanix cluster](#).

If the VM needs Internet access

1. Go to AWS console.
2. Create a new subnet 10.0.130.0/24 in the same VPC as the one created by Nutanix CFS.
3. Add a route to the route table of this subnet to direct all none local traffic to the NAT gateway above.
4. RDP into the bastion VM, go to the URL of the **Prism Element** you copied in the previous section and login.
5. Add a new network. Go to **Settings>Network Configuration>Create Subnet**. Use the same subnet 10.0.130.0/24 used in AWS.
6. Create all the VMs (AD, CC, VDA, and so on) in that new subnet.

If the VM does not need Internet access

1. RDP into the bastion VM, go to the URL of the **Prism Element** you copied in the previous section and login.
2. Add a new network. Go to **Settings>Network Configuration>Create Subnet**. Use the subnet 10.0.129.0/24.
3. Create all the VMs (AD, CC, VDA, and so on) in that subnet.

Tip:

Make sure that the time and timezone information in the VMs are set up correctly. This is especially true for AD.

Create host connection

1. Launch the Web Studio.
2. Select the hosting node, and click **Add Connection and Resources**.
3. On the **Connection** screen, select **Create a new Connection**, and in the **Connection address**, enter `https://xxx.xxx.xxx.xxx:9440`.
4. Follow the UI to complete the wizard.

Note:

To see the option for Nutanix in Web Studio, all connector VMs must have nutanix plug-in installed, even if they are not used in the nutanix zone.

Where to go next

- If you're in the initial deployment process, see [Create machine catalogs](#)

- For Nutanix specific information, see [Create a Nutanix catalog](#)

More information

- [Connections and resources](#)
- [Create machine catalogs](#)

Connection to VMware

April 4, 2024

[Create and manage connections and resources](#) describes the wizards that create a connection. The following information covers details specific to VMware virtualization environments.

Note:

Before creating a connection to VMware, you need to first finish setting up your VMware account as a resource location. See [VMware virtualization environments](#).

Create a connection

In the connection creation wizard:

1. Select the VMware connection type.
2. Specify the address of the access point for the vCenter SDK.
3. Specify the credentials for a VMware user account you set up earlier that has permissions to create VMs. Specify the user name in the form domain/username.

VMware SSL thumbprint

The VMware SSL thumbprint feature eliminates the need to manually create a host connection to a VMware vSphere hypervisor. It is no longer required to manually create a trust relationship between the Delivery Controllers in the Site and the hypervisor's certificate before creating a connection.

The VMware SSL thumbprint feature stores the untrusted certificate's thumbprint on the Site database. This configuration ensures that the hypervisor can be continuously identified as trusted by Citrix Virtual Apps and Desktops, even if not by the Controllers.

When creating a vSphere host connection in Studio, a dialog box allows you to view the certificate of the machine you are connecting to. You can then choose whether to trust it.

Required privileges

Create a VMware user account and one or more VMware roles with a set or all permissions listed in this article. Base the roles' creation on the specific level of granularity required over the user's permissions to request the various Citrix DaaS operations at any time. To grant the user-specific permissions at any point, associate them with the respective role, at the data center level at a minimum, with the **Propagate to children** option selected.

The following tables show the mappings between Citrix Virtual Apps and Desktops operations and the minimum required VMware privileges.

Note:

The permissions list display name, specifically the *User Interface*, is different for some vSphere versions. For example, in vSphere 6.7 the *User Interface* permission is **Change Memory** and **Change Settings**, rather than **Settings** and **Memory** as described in the required privileges noted on this page.

Add connections and resources

SDK	User interface
System. Anonymous, System. Read, and System.View	Added automatically. Can use the built-in read-only role.

Power management

SDK	User interface
VirtualMachine.Interact.PowerOff	Virtual machine > Interaction > Power Off
VirtualMachine.Interact.PowerOn	Virtual machine > Interaction > Power On
VirtualMachine.Interact.Reset	Virtual machine > Interaction > Reset
VirtualMachine.Interact.Suspend	Virtual machine > Interaction > Suspend
Datastore.Browse	Datastore > Browse datastore

Provision machines (Machine Creation Services)

To provision machines using MCS, the following permissions are mandatory:

SDK	User interface
Datastore.AllocateSpace	Datastore > Allocate space
Datastore.Browse	Datastore > Browse datastore
Datastore.FileManagement	Datastore > Low level file operations
Network.Assign	Network > Assign network
Resource.AssignVMToPool	Resource > Assign virtual machine to resource pool
VirtualMachine.Config.AddExistingDisk	Virtual machine > Configuration > Add existing disk
VirtualMachine.Config.AddNewDisk	Virtual machine > Configuration > Add new disk
Virtual machine.Config.Add or remove device	Virtual machine > Configuration > Add or remove device
VirtualMachine.Config.AdvancedConfig	Virtual machine > Configuration > Advanced
VirtualMachine.Config.RemoveDisk	Virtual machine > Configuration > Remove disk
VirtualMachine.Config.CPUCount	Virtual machine > Configuration > Change CPU count
VirtualMachine.Config.Memory	Virtual machine > Configuration > Change memory
VirtualMachine.Config.Settings	Virtual machine > Configuration > Change settings
VirtualMachine.Interact.PowerOff	Virtual machine > Interaction > Power Off
VirtualMachine.Interact.PowerOn	Virtual machine > Interaction > Power On
VirtualMachine.Interact.Reset	Virtual machine > Interaction > Reset
VirtualMachine.Interact.Suspend	Virtual machine > Interaction > Suspend
VirtualMachine.Inventory.CreateFromExisting	Virtual machine > Inventory > Create from existing
VirtualMachine.Inventory.Create	Virtual machine > Inventory > Create new
VirtualMachine.Inventory.Delete	Virtual machine > Inventory > Remove
VirtualMachine.Provisioning.Clone	Virtual machine > Provisioning > Clone virtual machine

VirtualMachine.State.CreateSnapshot	vSphere 5.0, Update 2, vSphere 5.1, Update 1, and vSphere 6.x, Update 1: Virtual machine > State > Create snapshot; vSphere 5.5: Virtual machine > Snapshot management > Create snapshot
-------------------------------------	--

Image update and rollback

SDK	User interface
Datastore.AllocateSpace	Datastore > Allocate space
Datastore.Browse	Datastore > Browse datastore
Datastore.FileManagement	Datastore > Low level file operations
Network.Assign	Network > Assign network
Resource.AssignVMToPool	Resource > Assign virtual machine to resource pool
VirtualMachine.Config.AddExistingDisk	Virtual machine > Configuration > Add existing disk
VirtualMachine.Config.AddNewDisk	Virtual machine > Configuration > Add new disk
VirtualMachine.Config.AdvancedConfig	Virtual machine > Configuration > Advanced
VirtualMachine.Config.RemoveDisk	Virtual machine > Configuration > Remove disk
VirtualMachine.Interact.PowerOff	Virtual machine > Interaction > Power Off
VirtualMachine.Interact.PowerOn	Virtual machine > Interaction > Power On
VirtualMachine.Interact.Reset	Virtual machine > Interaction > Reset
VirtualMachine.Inventory.CreateFromExisting	Virtual machine > Inventory > Create from existing
VirtualMachine.Inventory.Create	Virtual machine > Inventory > Create new
VirtualMachine.Inventory.Delete	Virtual machine > Inventory > Remove
VirtualMachine.Provisioning.Clone	Virtual machine > Provisioning > Clone virtual machine

Delete provisioned machines

SDK	User interface
Datastore.Browse	Datastore > Browse datastore
Datastore.FileManagement	Datastore > Low level file operations
VirtualMachine.Config.RemoveDisk	Virtual machine > Configuration > Remove disk
VirtualMachine.Interact.PowerOff	Virtual machine > Interaction > Power Off
VirtualMachine.Inventory.Delete	Virtual machine > Inventory > Remove

Storage Profile (vSAN)

To view, create, or delete storage policies during catalog creations on a vSAN datastore, the following permissions are mandatory:

SDK	User interface
storage.Profile-driven storage update	PROFILE-DRIVEN STORAGE > Profile-driven storage update
storage.Profile-driven storage view	PROFILE-DRIVEN STORAGE > Profile-driven storage view

Tags and Custom Attributes

Tags and custom attributes allow you to attach metadata to the VMs created in vSphere inventory and make it easier to search and filter these objects. To create, edit, assign, and delete tags or categories, the following permissions are mandatory:

SDK	User interface
Tagging.Create	vSphere Tagging > Create vSphere Tag
Tagging.Create	vSphere Tagging > Create vSphere Tag Category
Tagging.Edit	vSphere Tagging > Edit vSphere Tag
Tagging.Edit	vSphere Tagging > Edit vSphere Tag Category
Tagging.Delete	vSphere Tagging > Delete vSphere Tag
Tagging.Delete	vSphere Tagging > Delete vSphere Tag Category

SDK	User interface
Tagging.Assign	vSphere Tagging > Assign or Unassign vSphere Tag
Tagging.Assign	vSphere Tagging > Assign or Unassign vSphere Tag on Object
Global.ManageCustomFields	Global > Manage custom attributes
Global.SetCustomField	Global > Set custom attribute

Note:

When MCS creates a machine catalog, it tags the target VMs with special name tags. These tags differentiate the master image from MCS created VMs and prevent using MCS created VMs for image preparation. You can identify the difference by the value of `XdProvisioned` attribute in vCenter. The attribute is set to **True** if MCS creates VMs.

Cryptographic operations

Cryptographic operations privileges control who can perform which type of cryptographic operation on which type of object. vSphere Native Key Provider uses the `Cryptographer.*` privileges. The following minimum permissions are required for cryptographic operations:

Note:

These permissions are required for creating MCS machine catalogs with vTPM equipped VM.

SDK	User interface
Cryptographic operations.Direct Access	Privileges > All Privileges > Cryptographic operations > Direct Access
Cryptographic operations.Add disk	Privileges > All Privileges > Cryptographic operations > Add disk
Cryptographic operations.Clone	Privileges > All Privileges > Cryptographic operations > Clone
Cryptographic operations.Encrypt	Privileges > All Privileges > Cryptographic operations > Encrypt
Cryptographic operations.Encrypt new	Privileges > All Privileges > Cryptographic operations > Encrypt new

SDK	User interface
Cryptographic operations.Decrypt	Privileges > All Privileges > Cryptographic operations > Decrypt
Cryptographic operations.Migrate	Privileges > All Privileges > Cryptographic operations > Migrate
Cryptographic operations.Read KMS information	Privileges > All Privileges > Cryptographic operations > Read KMS information

Provision machines (Citrix Provisioning)

These permissions to clone and deploy a template are required to provision VMs using Citrix Virtual Apps and Desktops Setup Wizard and Export Devices Wizard through the Citrix Provisioning console. Set the permissions while creating a hosting connection. You need all the permissions from Provision machines (Machine Creation Services) and the following.

SDK	User interface
VirtualMachine.Config.AddRemoveDevice	Virtual machine > Configuration > Add or remove device
VirtualMachine.Config.CPUCount	Virtual machine > Configuration > Change CPU Count
VirtualMachine.Config.Memory	Virtual machine > Configuration > Memory
VirtualMachine.Config.Settings	Virtual machine > Configuration > Settings
VirtualMachine.Provisioning.CloneTemplate	Virtual machine > Provisioning > Clone template
VirtualMachine.Provisioning.DeployTemplate	Virtual machine > Provisioning > Deploy template
vApp.Export	vApp > Export

Note:

The `vApp.Export` is required for creating MCS machine catalogs using machine profile.

Obtain and import a certificate

To protect vSphere communications, Citrix recommends that you use HTTPS rather than HTTP.

HTTPS requires digital certificates. Use a digital certificate issued from a certificate authority that meets your organization's security policy.

If you are unable to use a digital certificate issued from a certificate authority, you can use the VMware-installed self-signed certificate. Only use this method if your organization's security policy permits it. Add the VMware vCenter certificate to each Delivery Controller.

1. Add the fully qualified domain name (FQDN) of the computer running vCenter Server to the hosts file on that server, at %SystemRoot%/WINDOWS/system32/Drivers/etc/. This step is required only if the FQDN of the computer running vCenter Server is not already present in the domain name system.
2. Obtain the vCenter certificate using any of the following three methods:

From the vCenter server.

- a) Copy the file rui.crt from the vCenter server to a location accessible on your Delivery Controllers.
- b) On the Controller, navigate to the location of the exported certificate and open the rui.crt file.

Download the certificate using a web browser. If you are using Internet Explorer, right-click on Internet Explorer and choose **Run as Administrator** to download or install the certificate.

- a) Open your web browser and make a secure web connection to the vCenter server (for example <https://server1.domain1.com>).
- b) Accept the security warnings.
- c) Click the address bar displaying the certificate error.
- d) View the certificate and click the Details tab.
- e) Select **Copy to file and export in .CER format**, providing a name when prompted to do so.
- f) Save the exported certificate.
- g) Navigate to the location of the exported certificate and open the .CER file.

Import directly from Internet Explorer running as an administrator.

- Open your web browser and make a secure web connection to the vCenter server (for example <https://server1.domain1.com>).
- Accept the security warnings.
- Click the address bar displaying the certificate error.
- View the certificate.

3. Import the certificate into the certificate store on each of your Controllers.

- a) Click the **Install certificate** option, select **Local Machine**, and then click **Next**.
- b) Select **Place all certificates in the following store**, and then click **Browse**. Select **Trusted People** and then click **OK**. Click **Next** and then click **Finish**.

If you change the name of the vSphere server after installation, you must generate a new self-signed certificate on that server before importing the new certificate.

Where to go next

- If you're in the initial deployment process, see [Create machine catalogs](#)
- For VMware specific information, see [Create a VMware catalog](#)

More information

- [Connections and resources](#)
- [Create machine catalogs](#)

Connection to VMware cloud and partner solutions

June 27, 2023

After setting up [Azure VMware Solution \(AVS\) cluster](#), [Google Cloud VMware Engine](#), and [VMware cloud on AWS](#), create the connections. See [Connection to VMware](#) for creating connections.

Where to go next

- If you're in the initial deployment process, see [Create machine catalogs](#)
- For VMware specific information, see [Create a VMware catalog](#)

More information

- [Connections and resources](#)
- [Create machine catalogs](#)

Image management (Preview)

April 16, 2024

Introduction

The MCS catalog creation or update process has two phases:

- Mastering: a source image is converted into a published image
- Cloning: new VMs are created from the published image

With the image management functionality, MCS separates the mastering phase from the overall provisioning workflow.

You can prepare various MCS image versions (Prepared Image) from a single source image and use it across multiple different MCS machine catalogs. This implementation significantly reduces the storage and time costs, and simplifies the VM deployment and image update process.

The benefits of using this image management functionality are:

- Generate prepared images in advance without creating a catalog.
- Reuse prepared images in multiple scenarios, such as creating and updating a catalog.
- Significantly reduce catalog creation or update time.

Note:

- This feature is currently applicable to Azure and VMware virtualization environments.
- You can create an MCS machine catalog without using prepared images. In that case, you cannot get the benefits of the feature.

Use cases

Some of the use cases of image management functionality are:

- *Version management*: Image versions allow you to:
 - manage different iterations or updates to a particular image.
 - maintain multiple versions of an image for different purposes.
- *Logical grouping*: You can create multiple image definitions to:
 - logically group image versions based on various criteria such as project, department, or application and desktop type.
 - manage images more efficiently within an organization.

What is a prepared image?

With the image management functionality, MCS decouples the mastering phase from the overall catalog creation or update workflow and breaks down the process into two stages:

1. Create prepared images from a single source image.
2. Use the prepared image to create or update an MCS machine catalog.

You can create the prepared images in advance. You can use a single prepared image to create or update multiple MCS provisioned machine catalogs.

Understand how a prepared image is used across multiple MCS machine catalogs when you use the Web Studio from the image:

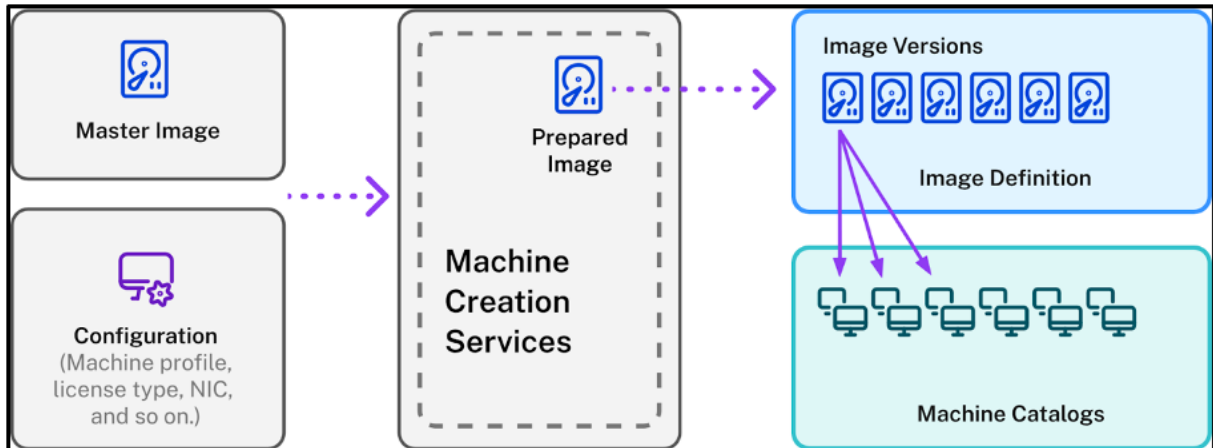

Image definition: Image definitions are a logical grouping of versions of an image. The image definition holds information about:

- why the image was created
- what OS it is for
- other information about using the image.

A catalog isn't created from an image definition, but from the image versions that are created based on the image definition.

Image version: Image versions manage versionings for the image definition. An image definition can have multiple image versions. Use the image versions as prepared images to create or update a catalog.

Alternatively, if you want to use PowerShell commands to create a provisioning scheme to create or update a catalog, then you must create a prepared image version spec based on the master image version spec as needed for your environment.

Requirement

- For Windows master image, only VDA images with version 2311 and later, and MCS/IO enabled are supported.

Limitations

Currently, the feature does not support the following:

- Multiple NIC in Azure
- Persistent data disk feature
- Hibernation for multi-session
- Image type change

Image lifecycle management using the Web Studio

Lifecycle of the image when you use the Web Studio is:

1. Create a prepared image: Create an image definition and its initial image version.
2. Create image versions from the initial image version.
3. Use an image version as a prepared image to create catalogs.
4. Update a machine catalog with a different prepared image.
5. Manage the image definitions and versions: Edit the name and description of image versions, and description of an image definition.
6. Delete an image version.
7. Delete an image definition.

Alternatively, you can also manage images using PowerShell. See Image lifecycle management using PowerShell.

Create or update a catalog using a prepared image

Create prepared images and use the prepared images to create or update an MCS machine catalog using:

- The Web Studio
- The PowerShell commands

Use the Web Studio

See the following topics:

- Understand Images node
- Create an image definition and initial image version
- Create image versions
- Create a machine catalog from the Images node

- Create a machine catalog from the Machine Catalogs node
- Update a machine catalog with a different prepared image
- Manage the image definitions and versions

Understand Images node

Use the **Images** node to create and manage MCS-prepared images. Its main view is divided into four parts:

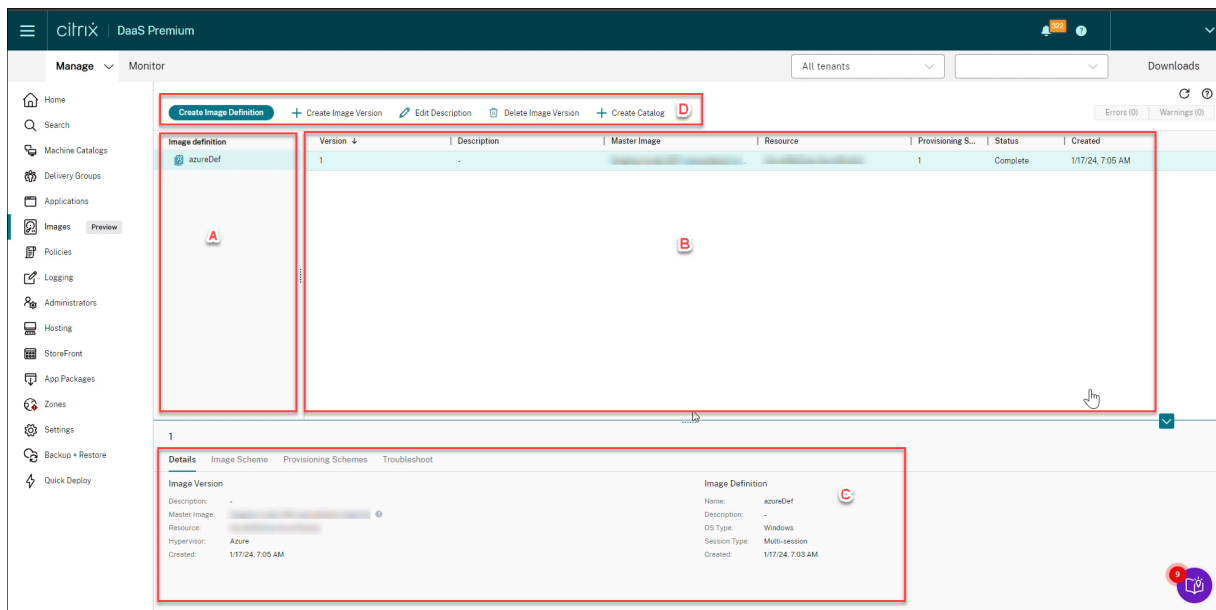

Label	Part	Description
A	Image definitions	Lists the previously created image definitions.
B	Image versions	Displays image versions of the selected image definition.
C	Details	<ul style="list-style-type: none"> • The Details tab displays detailed information about the selected image definition or version such as Master Image, Resource, Hypervisor, name of the image definition, OS type, and session type. • The Image Scheme tab displays information about the template used for preparing images such as hard disk, machine size, license type, disk encryption set, machine profile, and so

Label	Part	Description
D	Action bar	Lists the actions that you can take on image definitions and versions such as Create Image Version , Edit Description , Delete Image Version , and Create Catalog .

Create a machine catalog using the prepared image

The key steps to create an MCS machine catalog using the prepared image are:

1. Create the image definition and the initial image versions.
2. Use the image version as a prepared image to create a catalog.

Create an image definition and initial image version

To create an image definition and the initial image version, do the following:

1. Sign into Web Studio and select the **Images** node. Click **Next** on the **Introduction** page.
2. On the **Image Definition** page, specify the **OS type** and **Session type** for the image definition.
3. On the **Image** page, select **Resources** and a master image to use as a template for creating the image version. You can select the **Use a machine profile** checkbox and select a machine profile.

Note:

Before selecting an image, verify that the master image has VDA 2311 or later installed and the MCSIO driver is installed on the VDA.

4. (Only for Azure) On the **Storage and Licenses Types** page, select the storage and license type to be used as part of the image preparation process.

Note:

If you select a machine profile on the **Image** page, the license type of the machine profile is pre-selected based on the profile setting.

5. On the **Machine Specification** page:
 - For Azure, select a machine size. If you select a machine profile on the **Image** page, the machine size of the machine profile is selected by default.

- For VMware, if you select a machine profile, then you can see the Virtual CPU count derived from the machine profile and it is unchangeable. If you do not select a machine profile, then you can see only the memory size that is derived from the master image.
6. On the **NICs** page, select or add NICs for the preparation image. For each NIC, select an associated virtual network.

For VMware, if you do not select a machine profile, then the NIC associated with the master image is selected by default. If you select a machine profile, then the NICs are derived from the machine profile and the count is unchangeable.

Note:

Multiple NIC is not supported in Azure.

7. (Only for Azure) On the **Disk Settings** page, select the customer-managed encryption key (CMEK). If the machine profile doesn't have a CMEK but the master image has, it pre-selects the CMEK from the master image.
8. On the **Version Description** page, enter a description for the initial image version created.
9. On the **Summary** page, check the details of the image definition and the initial image version created. Enter a name and description for the image definition. Click **Finish**.

Create image versions

Image versions allow for the management of different iterations or updates to a particular image. This functionality enables you to maintain multiple versions of an image for different purposes.

To create image versions from the initial image version, do the following:

Note:

The hosting unit of all the image versions must be the same.

1. Go to the **Images** node, select an image version, and select **Create Image Version**.
2. If you want the configuration of the image version to be different from the initial configured image version, then configure the settings on the **Image, Storage and License Types, Machine Specification, NICs**, and **Disk Settings** pages of the **Create Image Version** dialog.
3. Add a description for the image version. Click **Finish**.

Create Image Version

✕

azureDef

- ✓ Introduction
- ✓ Image
- ✓ Storage and License Types
- ✓ Machine Specification
- ✓ NICs
- ✓ Disk Settings
- 7 Summary

Summary

Resources:	azure
Master image:	[REDACTED]
Machine profile:	[REDACTED]
Storage type:	Premium SSD (supports I/O-intensive workloads with significantly high throughput and low latency) [Azure Managed Disks]
License usage:	Use my Windows Server licenses
NICs:	0 - Using default
Machine size:	Standard_B2s
Disk encryption set:	/subscriptions/3fd5967-2bd5d0cad70c/resourceGroups/ZRJ-MCS/providers/Microsoft.Compute/diskEncryptionSets/^[REDACTED]

Version
2

Description (optional)

Image version description

Back
Finish
Cancel

Create a machine catalog from the Images node

Use the **Create catalog** option in the **Images** node to create a catalog using the image version.

Alternatively, you can select the version when creating a catalog in the **Machine Catalogs** node, linking to the prepared image option in the catalog creation workflow. See [Create a machine catalog from the Machine Catalogs node](#)

To create an MCS machine catalog from the **Images** node, do the following:

1. Select an image version and click **Create catalog**. Click **Next** on the **Introduction** page.
2. On the **Desktop Experience** page, select the required desktop experience.
3. From the **Image** page to **Disk Settings** page, the settings are pre-selected based on the selected image version.
4. (For Azure) On the **Resource Group** page, you can choose to create a new resource group or use an existing resource group to place the resources of this catalog.
5. Complete the settings on the following pages.
6. On the **Summary** page, check the details of the machine catalog. Enter a name and description for the machine catalog. Click **Finish**.
7. Go to the **Machine Catalogs** node to see the created machine catalog.

Create a machine catalog from the Machine Catalogs node

To create an MCS machine catalog from the **Machine Catalogs** node, do the following:

1. Click **Machine Catalogs** on the left navigation pane.
2. Click **Create Machine Catalog**. The **Machine Catalog Setup** page appears. Click **Next** through the **Introduction**, **Machine Type**, and **Machine Management** pages.
3. On the **Image** page:
 - a) Select **Prepared image**.
 - b) Under the **Prepared image**, select an image version of an image definition.
 - c) Click the image version name. To view more details about the selected image version, click the version number, which is underlined.
 - d) If the selected image version is configured with a machine profile, select a machine profile. If the selected image version is not configured with a machine profile, you cannot choose to use a machine profile.
4. Configure the settings on the following pages.
5. On the **Disk Settings** page, if the selected prepared image uses a disk encryption set, then you cannot remove the encryption set, but you can change the key to another encryption key.
6. (For Azure) On the **Resource Group** page, you can choose to create a new resource group or use an existing resource group to place the resources of this catalog.
7. Complete the settings on the following pages.
8. On the **Summary** page, check the details of the machine catalog. Enter a name and description for the machine catalog. Click **Finish**.

Update a machine catalog with a different prepared image

To update an existing MCS machine catalog with a different prepared image, do the following:

1. Click **Machine Catalogs** on the left navigation pane and select a machine catalog that you want to update. Right-click and select **Change Prepared Image**.
2. On the **Image** page, select a prepared image.
3. On the **Rollout strategy** page, select when you want to update this catalog with the selected prepared image.
4. On the **Summary** page, check the details. Click **Finish**.

You can see the history of image changes made to a catalog. To see the history, do the following:

1. Select a machine catalog.
2. Under the **Template Properties** tab in the **Prepared image** field, click **View Image history**.

Manage the image definitions and versions

You can edit and delete the image definitions and versions to manage the use of various created image versions and definitions.

Edit an image definition You can edit the name and description of an image definition.

To edit an image definition, do the following:

1. Go to the **Images** node, select an image definition, and select **Edit Image Definition**.

Edit image version You can edit the description of an image version to specify the purpose of that image version.

To edit an image version, do the following:

1. Go to the **Images** node, select an image version, and select **Edit Description**.

Delete an image version To delete an image version, do the following:

1. Go to the **Images** node, select an image version, and select **Delete Image Version**.

Note:

You cannot delete an image version if it is used by a machine catalog.

Delete an image definition To delete an image definition, do the following:

1. Go to the **Images** node, select an image definition, and select **Delete Image Definition**.

Note:

You cannot delete an image definition if it contains an image version.

Image lifecycle management using PowerShell If you want to use PowerShell commands to create a provisioning scheme, then you must create a prepared image version spec based on the master image version spec as needed for your environment.

Master image version spec: A master image version spec is a specific image added or created under an image version. You can add an existing image in the hypervisor as a master image version spec or create a prepared image version spec based on the master image version spec as needed for your environment. The prepared image version spec can be used for multiple provisioning schemes.

The lifecycle of an image when using PowerShell commands is:

1. Create an image:
 - a) Create an image definition.
 - b) Create an image version.
 - c) Add a master image version spec.
 - d) Create a prepared image version spec.
2. Create an MCS machine catalog using a prepared image version spec:
 - a) Create a broker catalog.
 - b) Create an identity pool.
 - c) Create a provisioning scheme with the parameter of prepared image version spec Uid using the `New-ProvScheme` command.
 - d) Link the broker catalog with the provisioning scheme.
3. Create VMs in the MCS machine catalog.
4. Change the prepared image version spec of a provisioning scheme using `Set-ProvScheme` command.
5. Manage the image definitions and versions: Edit the image versions and image definitions.
6. Delete an MCS machine catalog: The deletion order is: prepared image version spec > master image version spec > image version > image definition. Before deleting the image version spec, ensure that the prepared image version spec is not associated with any MCS machine catalog.

Use PowerShell

You can do the following using PowerShell commands:

- Create a prepared image
- Create a catalog using prepared image version spec
- Update a catalog using a prepared image version spec
- Delete image definition, image version, and prepared image version spec
- Manage image definition and image version
- Get image definition, image version, prepared image version spec, and provisioning scheme details

Create a prepared image

The detailed PowerShell commands to create a prepared image version spec are as follows:

1. Check the available image definition names using the `Test-ProvImageDefinitionNameAvailable` command. For example,

```
1 Test-ProvImageDefinitionNameAvailable -ImageDefinitionName <string
   []>
2 <!--NeedCopy-->
```

2. Create an image definition using the `New-ProvImageDefinition` command. For example,

```
1 New-ProvImageDefinition -ImageDefinitionName image1 -OsType
   Windows -VdaSessionSupport MultiSession
2 <!--NeedCopy-->
```

3. Create an image version using the `New-ProvImageVersion` command. For example,

```
1 New-ProvImageVersion -ImageDefinitionName image1 -Description "
   version 1"
2 <!--NeedCopy-->
```

4. Add a master image version spec to the image version using the `Add-ProvImageVersionSpec` command. For example,

```
1 Add-ProvImageVersionSpec -ImageDefinitionName image1 -
   ImageVersionNumber 1 -HostingUnitName azure -MasterImagePath "
   XDHyp:\HostingUnits\azure\image.folder\azureresourcegroup.
   resourcegroup\win2022-snapshot.snapshot"
2 <!--NeedCopy-->
```

Note:

You can add only one master image version spec to one image version for a hosting unit.

5. Create a prepared image version spec from the master image version spec using the `New-ProvImageVersionSpec` command. For example,

```

1 New-ProvImageVersionSpec
2 -SourceImageVersionSpecUid c6e7384c-b2f8-46d6-9519-29a2c57ed3cb
3 -NetworkMapping @{
4   "0"="XDHyp:\HostingUnits\azure\virtualprivatecloud.folder\
      azureresourcegroup.resourcegroup\azure-vnet-eastus.
      virtualprivatecloud\dev.network"
5 -ServiceOffering "XDHyp:\HostingUnits\azure\serviceoffering.folder
   \Standard_B2ms.serviceoffering" -CustomProperties "<
   CustomProperties xmlns="http://schemas.citrix.com/2014/xd/
   machinecreation" xmlns:xsi="http://www.w3.org/2001/XMLSchema-
   instance"></CustomProperties>" -RunAsynchronously
6 <!--NeedCopy-->

```

Note:

One hosting unit and preparation type can have only one prepared instance.

Example of the complete set of Powershell commands to create image definition, image version, and prepared image version spec in Azure:

```

1 $ImageDefintion = New-ProvImageDefinition
2 -ImageDefinitionName image1 -OsType Windows -VdaSessionSupport
   MultiSession
3 $ImageVersion = New-ProvImageVersion -ImageDefinitionName
   $ImageDefintion.ImageDefinitionName -Description "version 1"
4 $MasterImagePath = "XDHyp:\HostingUnits\azure\image.folder\
   azureresourcegroup.resourcegroup\win2022-snapshot.snapshot"
5 $SourceImageVersionSpec = Add-ProvImageVersionSpec -ImageDefinitionName
   $ImageVersion.ImageDefinitionName -ImageVersionNumber $ImageVersion
   .ImageVersionNumber -HostingUnitName azure -MasterImagePath
   $MasterImagePath
6 $Task = New-ProvImageVersionSpec -SourceImageVersionSpecUid
   $SourceImageVersionSpec.ImageVersionSpecUid -NetworkMapping @{
7   "0"="XDHyp:\HostingUnits\azure\virtualprivatecloud.folder\
   azureresourcegroup.resourcegroup\azure-vnet-eastus.
   virtualprivatecloud\dev.network" }
8   -ServiceOffering "XDHyp:\HostingUnits\azure\serviceoffering.folder\
   Standard_B2ms.serviceoffering" -CustomProperties "<
   CustomProperties xmlns="http://schemas.citrix.com/2014/xd/
   machinecreation" xmlns:xsi="http://www.w3.org/2001/XMLSchema-
   instance"></CustomProperties>" -RunAsynchronously
9 Get-ProvTask -TaskId $Task.TaskId
10 <!--NeedCopy-->

```

Example of the complete set of Powershell commands to create image definition, image version, and prepared image version spec in VMware:

```

1 $ImageDefintion = New-ProvImageDefinition -ImageDefinitionName image2 -
   OsType Windows -VdaSessionSupport SingleSession
2 $ImageVersion = New-ProvImageVersion -ImageDefinitionName
   $ImageDefintion.ImageDefinitionName -Description "version 1"

```

```

3 $MasterImagePath = "XDHyp:\HostingUnits\vmware\win10-master.vm\win10-
  master-snap.snapshot"
4 $SourceImageVersionSpec = Add-ProvImageVersionSpec -ImageDefinitionName
  $ImageVersion.ImageDefinitionName -ImageVersionNumber $ImageVersion
  .ImageVersionNumber -HostingUnitName vmware -MasterImagePath
  $MasterImagePath
5 $Task = New-ProvImageVersionSpec -SourceImageVersionSpecUid
  $SourceImageVersionSpec.ImageVersionSpecUid -NetworkMapping @{
6   "0"="XDHyp:\HostingUnits\vmware\DSwitch-VM Network.network" }
7   -VMCpuCount 2 -VMMemoryMB 4096 -RunAsynchronously
8 Get-ProvTask -TaskId $Task.TaskId
9 <!--NeedCopy-->

```

Note:

- All image version specs in an image definition must belong to the same hosting unit.
- An image version can have only one master image version spec and one prepared image version spec.
- All image version specs must either have a machine profile or none of the image version specs must have a machine profile.
- You cannot specify a resource group while creating an image version spec.

Create a catalog using a prepared image version spec

Create an MCS machine catalog from the prepared image version spec using the `New-ProvScheme` command. For example,

```

1 New-ProvScheme -ProvisioningSchemeName <string> -ImageVersionSpecUid <
  Guid> -HostingUnitUid <Guid> -IdentityPoolUid <Guid> [-VMCpuCount <
  int>] [-VMMemoryMB <int>] [-UseWriteBackCache] [-NetworkMapping <
  Hashtable>] [-CleanOnBoot] [-Scope <string[]>] [-Metadata <Hashtable
  >] [-ServiceOffering <string>] [-SecurityGroup <string[]>] [-
  TenancyType <string>] [-MachineProfile <string>] [-CustomProperties
  <string>] [-ResetAdministratorPasswords] [-
  UseFullDiskCloneProvisioning] [-RunAsynchronously] [-
  PurgeJobOnSuccess] [-ProvisioningSchemeType <ProvisioningSchemeType
  >]
2 <!--NeedCopy-->

```

Or,

```

1 New-ProvScheme -ProvisioningSchemeName <string> -ImageVersionSpecUid <
  Guid> -HostingUnitName <string> -IdentityPoolName <string> [-
  VMCpuCount <int>] [-VMMemoryMB <int>] [-UseWriteBackCache] [-
  NetworkMapping <Hashtable>] [-CleanOnBoot] [-Scope <string[]>] [-
  Metadata <Hashtable>] [-ServiceOffering <string>] [-SecurityGroup <
  string[]>] [-TenancyType <string>] [-MachineProfile <string>] [-
  CustomProperties <string>] [-ResetAdministratorPasswords] [-
  UseFullDiskCloneProvisioning] [-RunAsynchronously] [-

```

```

    PurgeJobOnSuccess] [-ProvisioningSchemeType <ProvisioningSchemeType
    >]
2 <!--NeedCopy-->

```

Example of the complete set of Powershell commands to create a catalog in Azure:

```

1 $Catalog = New-BrokerCatalog -AllocationType "Random" -IsRemotePC
  $False -MinimumFunctionalLevel "L7_20" -Name "azurecatalog" -
  PersistUserChanges "Discard" -ProvisioningType "MCS" -Scope @() -
  SessionSupport "MultiSession"
2 $IdentityPool = New-AcctIdentityPool -AllowUnicode -Domain "azure.
  local" -IdentityPoolName "azurecatalog" -IdentityType "
  ActiveDirectory" -NamingScheme "azure##" -NamingSchemeType "Numeric
  " -Scope @()
3 $PreparedImageVersionSpec = Get-ProvImageVersionSpec -
  ImageDefinitionName image1 -ImageVersionNumber 1 -Filter "
  PreparationType -eq 'Mcs'"
4 $Task = New-ProvScheme -ProvisioningSchemeName azurecatalog -
  ImageVersionSpecUid $PreparedImageVersionSpec.ImageVersionSpecUid -
  HostingUnitName azure -IdentityPoolName azurecatalog -CleanOnBoot -
  Scope @() -SecurityGroup @() -ServiceOffering "XDHyp:\HostingUnits\
  azure\serviceoffering.folder\Standard_B2s.serviceoffering" -
  NetworkMapping @{
5   "0"="XDHyp:\HostingUnits\azure\virtualprivatecloud.folder\
  azureresourcegroup.resourcegroup\azure-vnet-eastus.
  virtualprivatecloud\dev.network" }
6   -CustomProperties "<CustomProperties xmlns='http://schemas.citrix.
  com/2014/xd/machinecreation'" xmlns:xsi='http://www.w3.org/2001/
  XMLSchema-instance'"><Property xsi:type='StringProperty' Name='
  StorageAccountType' Value='StandardSSD_LRS' /></
  CustomProperties>" -RunAsynchronously
7 Get-ProvTask -TaskId $Task.TaskId
8 $ProvScheme = Get-ProvScheme -ProvisioningSchemeName azurecatalog
9 Set-BrokerCatalog -Name $Catalog.Name -ProvisioningSchemeId $ProvScheme
  .ProvisioningSchemeUid
10 <!--NeedCopy-->

```

Example of the complete set of Powershell commands to create a catalog in VMware:

```

1 $Catalog = New-BrokerCatalog -AllocationType "Random" -IsRemotePC
  $False -MinimumFunctionalLevel "L7_20" -Name "vmwarecatalog" -
  PersistUserChanges "Discard" -ProvisioningType "MCS" -Scope @() -
  SessionSupport "MultiSession"
2 $IdentityPool = New-AcctIdentityPool -AllowUnicode -Domain "vmware.
  local" -IdentityPoolName "vmwarecatalog" -IdentityType "
  ActiveDirectory" -NamingScheme "vmware##" -NamingSchemeType "
  Numeric" -Scope @()
3 $PreparedImageVersionSpec = Get-ProvImageVersionSpec -
  ImageDefinitionName image2 -ImageVersionNumber 1 -Filter "
  PreparationType -eq 'Mcs'"
4 $Task = New-ProvScheme -ProvisioningSchemeName vmwarecatalog -
  ImageVersionSpecUid $PreparedImageVersionSpec.ImageVersionSpecUid -
  HostingUnitName vmware -IdentityPoolName vmwarecatalog -CleanOnBoot

```

```

    -Scope @() -SecurityGroup @() -NetworkMapping @{
5   "0"="XDHyp:\HostingUnits\vmware\DSwitch-VM Network.network" }
6   -VMCpuCount 2 -VMMemoryMB 4096 -RunAsynchronously
7   Get-ProvTask -TaskId $Task.TaskId
8   $ProvScheme = Get-ProvScheme -ProvisioningSchemeName vmwarecatalog
9   Set-BrokerCatalog -Name $Catalog.Name -ProvisioningSchemeId $ProvScheme
    .ProvisioningSchemeUid
10  <!--NeedCopy-->

```

Update a catalog using a prepared image version spec

You can update a catalog using the `Set-ProvSchemeImage` command. For example,

```

1  Set-ProvSchemeImage -ProvisioningSchemeUid <Guid> -ImageVersionSpecUid
    <Guid> [-DoNotStoreOldImage] [-RunAsynchronously] [-
    PurgeJobOnSuccess]
2  <!--NeedCopy-->

```

Or,

```

1  Set-ProvSchemeImage -ProvisioningSchemeName <string> -
    ImageVersionSpecUid <Guid> [-DoNotStoreOldImage] [-RunAsynchronously
    ] [-PurgeJobOnSuccess]
2  <!--NeedCopy-->

```

Example of the complete set of Powershell commands to update a catalog:

```

1  $PreparedImageVersionSpec = Get-ProvImageVersionSpec -
    ImageDefinitionName image1 -ImageVersionNumber 2 -Filter "
    PreparationType -eq 'Mcs'"
2  Set-ProvSchemeImage -ProvisioningSchemeName azurecatalog -
    ImageVersionSpecUid $PreparedImageVersionSpec.ImageVersionSpecUid -
    RunAsynchronously
3  <!--NeedCopy-->

```

Delete image definition, image version, and prepared image version spec

Consider the following before deleting an image definition, image version, and prepared image version spec:

- An image definition can't be deleted if it contains any image version.
- An image version can't be deleted if it contains any image version specification.
- A master image version spec can't be deleted if it is used by any other prepared image version spec.
- A prepared image version spec can't be deleted if it is used by any provisioning scheme.

The detailed steps are as follows:

1. Remove a prepared image version spec. For example,

```

1 $PreparedImageVersionSpec = Get-ProvImageVersionSpec -
  ImageDefinitionName image1 -ImageVersionNumber 1 -Filter "
  PreparationType -eq 'Mcs'"
2 Remove-ProvImageVersionSpec -ImageVersionSpecUid
  $PreparedImageVersionSpec.ImageVersionSpecUid -
  RunAsynchronously
3 <!--NeedCopy-->

```

Note:

Master image version spec can only be deleted when there is no associated prepared image version spec.

2. Remove master image version specification. For example,

```

1 $MasterImageVersionSpec = Get-ProvImageVersionSpec -
  ImageDefinitionName image1 -ImageVersionNumber 1 -Filter "
  PreparationType -eq 'None'"
2 Remove-ProvImageVersionSpec -ImageVersionSpecUid
  $PreparedImageVersionSpec.ImageVersionSpecUid -
  RunAsynchronously
3 <!--NeedCopy-->

```

3. Remove an image version. For example,

```

1 Remove-ProvImageVersion -ImageDefinitionName image1 -
  ImageVersionNumber 1
2 <!--NeedCopy-->

```

4. Remove an image definition. For example,

```

1 Remove-ProvImageDefinition -ImageDefinitionName image1
2 <!--NeedCopy-->

```

Example of the complete set of PowerShell commands:

```

1 $PreparedImageVersionSpec = Get-ProvImageVersionSpec -
  ImageDefinitionName image1 -ImageVersionNumber 1 -Filter "
  PreparationType -eq 'Mcs'"
2 $Task = Remove-ProvImageVersionSpec -ImageVersionSpecUid
  $PreparedImageVersionSpec.ImageVersionSpecUid -RunAsynchronously
3 $MasterImageVersionSpec = Get-ProvImageVersionSpec -ImageDefinitionName
  image1 -ImageVersionNumber 1 -Filter "PreparationType -eq 'None'"
4 $Task = Remove-ProvImageVersionSpec -ImageVersionSpecUid
  $PreparedImageVersionSpec.ImageVersionSpecUid -RunAsynchronously
5 Remove-ProvImageVersion -ImageDefinitionName image1 -ImageVersionNumber
  1
6 Remove-ProvImageDefinition -ImageDefinitionName image1
7 <!--NeedCopy-->

```

Manage image definition and image version

You can rename and edit an image definition, and edit an image version.

- Rename an image definition using the `Rename-ProvImageDefinition` command. For example:

```
1 Rename-ProvImageDefinition -ImageDefinitionUid <Guid> -
  NewImageDefinitionName <string>
2 <!--NeedCopy-->
```

Or,

```
1 Rename-ProvImageDefinition -ImageDefinitionName <string> -
  NewImageDefinitionName <string>
2 <!--NeedCopy-->
```

- Edit an image definition using the `Set-ProvImageDefinition` command. For example:

```
1 Set-ProvImageDefinition -ImageDefinitionUid <Guid> [-Description
  <string>]
2 <!--NeedCopy-->
```

Or,

```
1 Set-ProvImageDefinition -ImageDefinitionName <string> [-
  Description <string>]
2 <!--NeedCopy-->
```

- Edit an image version using the `Set-ProvImageVersion` command. For example:

```
1 Set-ProvImageVersion -ImageVersionUid <Guid> [-Description <
  string>]
2 <!--NeedCopy-->
```

Or,

```
1 Set-ProvImageVersion -ImageDefinitionName <string> -
  ImageVersionNumber <int> [-Description <string>]
2 <!--NeedCopy-->
```

Get image definition, image version, prepared image version spec, and provisioning scheme details

- Get image definition details using the `Get-ProvImageDefinition` command. For example:

```
1 Get-ProvImageDefinition [-ImageDefinitionName <string>] [-
  ImageDefinitionUid <Guid>] [-ReturnTotalRecordCount] [-
```

```

    MaxRecordCount <int>] [-Skip <int>] [-SortBy <string>] [-
    Filter <string>]
2 <!--NeedCopy-->

```

- Get image version details using the `Get-ProvImageVersion` command. For example:

- To list image versions in an image definition,

```

1 Get-ProvImageVersion -ImageDefinitionUid <Guid>
2 <!--NeedCopy-->

```

Or,

```

1 Get-ProvImageVersion -ImageDefinitionName <string>
2 <!--NeedCopy-->

```

- To get an image version detail,

```

1 Get-ProvImageVersion -ImageVersionUid <Guid>
2 <!--NeedCopy-->

```

Or,

```

1 Get-ProvImageVersion -ImageDefinitionName <string> -
  ImageVersionNumber <int>
2 <!--NeedCopy-->

```

- Get prepared image version spec using the `Get-ProvImageVersionSpec` command. For example:

- To list all prepared image version specs in an image version,

```

1 Get-ProvImageVersionSpec -ImageVersionUid <Guid>
2 <!--NeedCopy-->

```

- To list master image version specs in a prepared image version spec,

```

1 Get-ProvImageVersionSpec -ImageVersionUid <Guid> -Filter '
  PreparationType -eq "None"'
2 <!--NeedCopy-->

```

- To list prepared image version specs in an image version, which is associated with a master image,

```

1 Get-ProvImageVersionSpec -ImageVersionUid <Guid> -Filter '
  PreparationType -eq "MCS" -and SourceImageVersionSpecUid -
  eq "xxxxxxxx-xxxx-xxxx-xxxx-xxxxxxxxxxxx"'
2 <!--NeedCopy-->

```

- To get successful prepared image version specs in an image version,

```

1 Get-ProvImageVersionSpec -ImageVersionUid <Guid> -Filter '
  PreparationType -eq "MCS" -and SourceImageVersionSpecUid -
  eq "xxxxxxxx-xxxx-xxxx-xxxx-xxxxxxxxxxxx" -and
  ImageVersionSpecStatus -eq "Complete"
2 <!--NeedCopy-->

```

- To get a prepared image version spec detail,

```

1 Get-ProvImageVersionSpec -ImageVersionSpecUid <Guid>
2 <!--NeedCopy-->

```

- Get provisioning scheme details using the `Get-ProvScheme` command. For example:

```

1 Get-ProvScheme [[-ProvisioningSchemeName] <String>] [-
  ProvisioningSchemeUid <Guid>] [-ScopeId <Guid>] [-ScopeName <
  String>] [-ReturnTotalRecordCount] [-MaxRecordCount <Int32>]
  [-Skip <Int32>] [-SortBy <String>] [-Filter <String>] [-
  FilterScope <Guid>]
2 <!--NeedCopy-->

```

- Get prepared image version spec history of a provisioning scheme using the `Get-ProvSchemeImageVersionSpecHistory` command. For example:

```

1 Get-ProvSchemeImageVersionSpecHistory [-ProvisioningSchemeName <
  String>] [-ProvisioningSchemeUid <Guid>] [-ImageVersionSpecUid
  <Guid>] [-ImageVersionSpecHistoryUid <Guid>] [-
  ReturnTotalRecordCount] [-MaxRecordCount <Int32>] [-Skip <
  Int32>] [-SortBy <String>] [-Filter <String>] [-FilterScope <
  Guid>]
2 <!--NeedCopy-->

```

Create machine catalogs

March 8, 2024

Important:

As of Citrix Virtual Apps and Desktops 7 2006, if your current deployment uses any of the following technologies, you can upgrade your deployment to the current release only after removing End of Life (EOL) items that use those technologies.

- Personal vDisks (PvDs)
- AppDisks
- Public cloud host types: Citrix CloudPlatform, Microsoft Azure Classic

For details, see [Remove PVD, AppDisks, and unsupported hosts](#).

Note:

You can manage your Citrix Virtual Apps and Desktops deployment using two management consoles: Web Studio (web-based) and Citrix Studio (Windows-based). This article covers only Web Studio. For information about Citrix Studio, see the equivalent article in Citrix Virtual Apps and Desktops 7 2212 or earlier.

If you want to use public cloud host connections for your deployment, you need Hybrid Rights License to complete your fresh installation or upgrade to the current release.

When the installer detects one or more of the unsupported technologies or host connections without Hybrid Rights License, the upgrade pauses or stops. An explanatory message appears. The installer logs contain details. For more information, see [Upgrade a deployment](#).

Introduction

Collections of physical or virtual machines are managed as a single entity called a machine catalog. All the machines in a catalog have the same type of operating system: multi-session OS or single-session OS, and Windows or Linux machines.

Web Studio guides you to create the first machine catalog after you create the site. After you create the first catalog, Web Studio guides you to create the first delivery group. Later, you can change the catalog you created, and create more catalogs.

Tip:

Upgrading an existing deployment enables the Machine Creation Services (MCS) storage optimization (MCS I/O) feature, no additional configuration is required. The Virtual Delivery Agent (VDA) and the Delivery Controller upgrade handle the MCS I/O upgrade.

Overview

When you create a catalog of VMs, you specify how to provision those VMs. You can use Machine Creation Services (MCS). Or, you can use your own tools to provide machines.

Consider:

- MCS supports a single system disk from the virtual machine image. It ignores the rest of the data disks attached to that image.
- If you use MCS to provision VMs, you provide a master image (or snapshot of an image) to create identical VMs in the catalog. Before you create the catalog, you first use the tools to create and configure the master image. This process includes installing a Virtual Delivery Agent (VDA) on the image. Then you create the machine catalog in Web Studio. You select that image (or snapshot), specify the number of VMs to create in the catalog, and configure additional information.

- If your machines are already available, you must still create one or more machine catalogs for those machines.
- If you are creating a catalog using the PowerShell SDK directly, you can specify a hypervisor template (**VM Templates**), rather than an image or a snapshot.
- Using a template to provision a catalog is considered an experimental feature. When using this method, virtual machine preparation might fail. As a result, the catalog cannot be published using the template.

When using MCS or Citrix Provisioning to create the first catalog, you use the host connection that you configured when you created the site. Later (after you create your first catalog and delivery group), you can change information about that connection or create more connections.

After you complete the catalog creation wizard, tests run automatically to ensure that it is configured correctly. When the tests complete, you can view a test report. Run the tests at any time from Web Studio.

Note:

MCS does not support Windows 10 IoT Core and Windows 10 IoT Enterprise. Refer to the [Microsoft site](#) for more information.

For technical details about the Citrix Provisioning tools, see [Citrix Virtual Apps and Desktops Image Management](#).

RDS license check

Web Studio currently does not perform the check for valid Microsoft RDS licenses while creating a machine catalog that contains Windows multi-session OS machines. To view the status of the Microsoft RDS license for a Windows **multi-session OS machine**, go to Citrix Director. View the status of the Microsoft RDS license in the **Machine Details** panel. This panel is in the **Machine Details and the User Details** page. For more information, see [Microsoft RDS license health](#).

VDA registration

A VDA must be registered with a Delivery Controller when launching brokered sessions. Unregistered VDAs can result in underutilization of otherwise available resources. There are various reasons that a VDA might not be registered, many of which an administrator can troubleshoot. Web Studio provides troubleshooting information in the catalog creation wizard, and after you add machines from a catalog to a delivery group.

After you add existing machines using the wizard, the list of computer account names indicates whether each machine is suitable for adding to the catalog. Hover over the icon next to each machine to display an informative message about that machine.

If the message identifies a problematic machine, either remove that machine, or add the machine. For example, if a message indicates that information might not be obtained about a machine, add the machine anyway.

For more information, see:

- [CTX136668](#) for VDA registration troubleshooting guidance
- VDA versions and functional levels
- [VDA registration methods](#)

MCS catalog creation summary

Here's a brief overview of default MCS actions after you provide information in the catalog creation wizard.

- If you selected a master image (rather than a snapshot), MCS creates a snapshot.
- MCS creates a full copy of the snapshot and places the copy on each storage location defined in the host connection.
- MCS adds the machines to Active Directory, which creates unique identities.
- MCS creates the number of VMs specified in the wizard, with two disks defined for each VM. In addition to the two disks per VM, a master is also stored in the same storage location. If you have multiple storage locations defined, each gets the following disk types:
 - The full copy of the snapshot which is read-only and shared across the just-created VMs.
 - A unique 16 MB identity disk that gives each VM a unique identity. Each VM gets an identity disk.
 - A unique difference disk to store writes made to the VM. This disk is thin provisioned (if supported by the host storage) and increases to the maximum size of the master image, if necessary. Each VM gets a difference disk. The difference disk holds changes made during sessions. It is permanent for dedicated desktops. For pooled desktops, it is deleted and a new one created after each restart via the delivery controller.

Alternatively, when creating VMs to deliver static desktops, you can specify (on the **Machines** page of the catalog creation wizard) thick (full copy) VM clones. Full clones do not require retention of the master image on every data store. Each VM has its own file.

MCS storage considerations

There are many factors when deciding on storage solutions, configurations, and capacities for MCS. The following information provides proper considerations for storage capacity:

Capacity considerations:

- Disks

The Delta or Differencing (Diff) Disks consume the largest amount of space in most MCS deployments for each VM. Each VM created by MCS is given at minimum 2 disks upon creation.

- Disk0 = Diff Disk: contains the OS when copied from the Master Base Image.
- Disk1 = Identity Disk: 16 MB - contains Active Directory data for each VM.

As the product evolves, you might have to add more disks to satisfy certain use cases and feature consumption. For example:

- [MCS Storage Optimization](#) creates a write cache style disk for each VM.
- MCS added the ability to use [full clones](#) as opposed to the Delta disk scenario described in the previous section.

Hypervisor features might also enter into the equation. For example:

- [XenServer IntelliCache](#) creates a Read Disk on local storage for each XenServer. This option saves on IOPS against the master image which might be held on the shared storage location.

- Hypervisor overhead

Different hypervisors use specific files that create overhead for VMs. Hypervisors also use storage for management and general logging operations. Calculate the space to include overhead for:

- [Log files](#)
- Hypervisor specific files. For example:
 - * VMware adds more files to the **VM storage** folder. See [VMware Best Practices](#).
 - * Calculate your total virtual machine size requirements. Consider a virtual machine containing 20 GB for the virtual disk, 16 GB for the swap file, and 100 MB for log files consuming 36.1 GB total.
- [Snapshots for XenServer](#); [Snapshots for VMware](#).

- Process overhead

Creating a catalog, adding a machine, and updating a catalog have unique storage implications. For example:

- [Initial catalog creation](#) requires a copy of the base disk to be copied to each storage location.
 - * It also requires you to create a [Preparation VM](#) temporarily.
- [Adding a machine](#) to a catalog does not require copying of the base disk to each storage location. Catalog creation varies based on the features selected.

- [Updating the catalog](#) to create an extra base disk on each storage location. Catalog updates also experience a temporary storage peak where each VM in the catalog has 2 Diff disks for a certain amount of time.

More considerations:

- **RAM sizing:** Affects the size of certain hypervisor files and disks, including I/O optimization disks, write cache, and snapshot files.
- **Thin / Thick provisioning:** NFS storage is preferred due to the thin provisioning capabilities.

Machine Creation Services (MCS) storage optimization

With the Machine Creation Services (MCS) storage optimization feature, referred to as MCS I/O:

- The write cache container is *file-based*, the same functionality found in Citrix Provisioning. For example, the Citrix Provisioning write cache file name is `D:\vdiskdif.vhdx` and the MCS I/O write cache file name is `D:\mcsdif.vhdx`.
- Achieve diagnostic improvements by including support for a Windows crash dump file written to the write cache disk.
- MCS I/O retains the technology *cache in RAM with overflow to hard disk* to provide the most optimal multi-tier write cache solution. This functionality allows an administrator to balance between the cost in each tier, RAM and disk, and performance to meet the desired workload expectation.

Updating the write cache method from *disk-based* to *file-based* requires the following changes:

1. MCS I/O no longer supports RAM only cache. Specify a disk size in Web Studio during machine catalog creation.
2. The VM write cache disk is created and formatted automatically when booting a VM for the first time. Once the VM is up, the write cache file `mcsdif.vhdx` is written into the formatted volume `MCSWCDisk`.
3. The pagefile is redirected to this formatted volume, `MCSWCDisk`. As a result, this disk size considers the total amount of disk space. It includes the delta between the disk size and the generated workload plus the pagefile size. This is typically associated with VM RAM size.

Enabling MCS storage optimization updates To enable MCS I/O storage optimization functionality, upgrade the Delivery Controller and the VDA to the latest version of Citrix Virtual Apps and Desktops.

Note:

If you upgrade an existing deployment which has MCS I/O enabled, no additional configuration is required. The VDA and the Delivery Controller upgrade handle the MCS I/O upgrade.

When enabling the MCS storage optimization update, consider the following:

- When creating a machine catalog, the administrator can configure the RAM and disk size.

Machine Catalog Setup

Virtual Machines

How many virtual machines do you want to create?
2

Configure your machines.
Total memory (MB) on each machine:
16385

Configure a cache for temporary data on each machine.

Memory allocated to cache (MB): 2048

Disk cache size (GB): 100

By default, both check boxes are cleared. (Temporary data is written to OS storage for each VM.) To cache temporary data, a current MCSIO driver must be installed on the VM, in addition to selecting one or both check boxes and values above.

[Learn more](#)

- Updating an existing machine catalog to a new VM snapshot containing a VDA configured for version 1903 results in the following behavior: the new snapshot continues to use the existing catalog's MCS I/O setting for RAM and disk size. The existing raw disk is formatted.

Important:

MCS storage optimization changed with Citrix Virtual Apps and Desktops version 1903. This release supports file-based write cache technology, providing better performance and stability. The new functionality provided by MCS I/O might require a higher write cache storage requirement compared to previous Citrix Virtual Apps and Desktops releases. Citrix recommends that you reevaluate the disk size to ensure that it has sufficient disk space for the allocated workflow and extra pagefile size. The pagefile size is typically related to the amount of system RAM. If the existing catalog disk size is insufficient, create a machine catalog and allocate a larger write cache disk.

Assign a specific drive letter to MCS I/O write-back cache disk

You can assign a specific drive letter to the MCS I/O write-back cache disk. This implementation helps you to avoid conflicts between the drive letter of any applications that you use and the drive letter of the MCS I/O write-back cache disk. To assign drive letter to MCS I/O write-back cache disk, you can use PowerShell commands. The supported hypervisors are Azure, GCP, VMware, SCVMM, and XenServer.

Note:

This feature requires VDA version 2305 or later.

Limitations

- Applicable to only Windows operating system
- Applicable drive letter for write-back cache disk: E to Z
- Not applicable when Azure temporary disk is used as a write-back cache disk
- Applicable only when you create a new machine catalog

Assign a drive letter to write-back cache disk

To assign a drive letter to a write-back cache disk:

1. Open the **PowerShell** window.
2. Run `asnp citrix*`.
3. Create an identity pool if not already created.
4. Create a provisioning scheme using the `New-ProvScheme` command with the property `WriteBackCacheDriveLetter`. For example:

```

1 New-ProvScheme -CleanOnBoot `
2 -HostingUnitName "<name>" `
3 -IdentityPoolName $schemeName `
4 -ProvisioningSchemeName $schemeName `
5 -InitialBatchSizeHint 1 `
6 -UseWriteBackCache -WriteBackCacheDiskSize 127 -
   WriteBackCacheMemorySize 256 -WriteBackCacheDriveLetter E `
7 -MasterImageVM "XDHyp:\HostingUnits\<name>\image.folder\abcd-
   resources.resourcegroup\
   MCSIOMasterVm_OsDisk_1_d3e2d6352xxxxxxxxx2130aa145ec77.
   manageddisk" `
8 -NetworkMapping @{
9   "0"="XDHyp:\\HostingUnits\\name\\virtualprivatecloud.folder\\East
   US.region\\virtualprivatecloud.folder\\abcd-resources.
   resourcegroup\\abcd-resources-vnet.virtualprivatecloud\\
   default.network" }
10 `
11 -ServiceOffering "XDHyp:\\HostingUnits\\<name>\\serviceoffering.
   folder\\Standard_D2s_v5.serviceoffering" `
12 -CustomProperties '<CustomProperties xmlns="http://schemas.citrix.
   com/2014/xd/machinecreation" xmlns:xsi="http://www.w3.org/2001/
   XMLSchema-instance">
13 <Property xsi:type="StringProperty" Name="UseManagedDisks" Value="
   true" />

```



```
14 <Property xsi:type="StringProperty" Name="OsType" Value="Windows"
    />
15 <Property xsi:type="StringProperty" Name="StorageType" Value="
    Premium_LRS"/>
16 <Property xsi:type="StringProperty" Name="PersistWBC" Value="false
    " />
17 <Property xsi:type="StringProperty" Name="PersistOsDisk" Value="
    false" />
18 <Property xsi:type="StringProperty" Name="PersistVm" Value="false"
    />
19 <Property xsi:type="StringProperty" Name="WBCDiskStorageType"
    Value="Premium_LRS" />
20 <Property xsi:type="StringProperty" Name="UseTempDiskForWBC" Value
    ="false" />
21 <Property xsi:type="StringProperty" Name="ResourceGroups" Value="
    abcd-group1" />
22 <Property xsi:type="StringProperty" Name="LicenseType" Value="
    Windows_Client" />
23 <Property xsi:type="StringProperty" Name="SchemaVersion" Value="2"
    />
24 </CustomProperties>'
25 <!--NeedCopy-->
```

5. Finish creating the catalog. For information, see <https://developer-docs.citrix.com/projects/citrix-virtual-apps-desktops-sdk/en/latest/creating-a-catalog/>.

Prepare a master image

For information about creating connections hosts, see [Connections and resources](#).

The master image contains the operating system, non-virtualized applications, VDA, and other software.

Good to know:

- A master image might also be known as a clone image, golden image, base VM, or base image. Host vendors use different terms.
- Ensure that the host has enough processors, memory, and storage to accommodate the number of machines created.
- Configure the correct amount of hard disk space needed for desktops and applications. That value cannot be changed later or in the machine catalog.
- Remote PC Access machine catalogs do not use master images.

Install and configure the following software on the master image:

- Integration tools for your hypervisor (such as Citrix VM Tools, Hyper-V Integration Services, or VMware tools). If you omit this step, applications and desktops might not function correctly.

- A VDA. Citrix recommends installing the latest version to allow access to the newest features. Failure to install a VDA on the master image causes the catalog creation to fail.
- Third-party tools as needed, such as antivirus software or electronic software distribution agents. Configure services with settings that are appropriate for users and the machine type (such as updating features).
- Third-party applications that you are not virtualizing. Citrix recommends virtualizing applications. Virtualizing reduces costs by eliminating having to update the master image after adding or reconfiguring an application. Also, fewer installed applications reduce the size of the master image hard disks, which saves storage costs.
- App-V clients with the recommended settings, if you plan to publish App-V applications. The App-V client is available from Microsoft.
- When using MCS, if you localize Microsoft Windows, install the locales and language packs. During provisioning, when a snapshot is created, the provisioned VMs use the installed locales and language packs.

Important:

If you are using MCS, do not run Sysprep on master images.

To prepare a master image:

1. Using your hypervisor's management tool, create a master image and then install the operating system, plus all service packs and updates. Specify the number of vCPUs. You can also specify the vCPU value if you create the machine catalog using PowerShell. You cannot specify the number of vCPUs when creating a catalog using Web Studio. Configure the amount of hard disk space needed for desktops and applications. That value cannot be changed later or in the catalog.
2. Ensure that the hard disk is attached at device location 0. Most standard master image templates configure this location by default, but some custom templates might not.
3. Install and configure the software listed above on the master image.
4. If you are not using MCS, join the master image to the domain where applications and desktops are members. Ensure that the master image is available on the host where the machines are created. If you are using MCS, joining the master image to a domain is not required. The provisioned machines are joined to the domain specified in the catalog creation wizard.
5. Citrix recommends that you create and name a snapshot of your master image. If you specify a master image rather than a snapshot when creating a catalog, Web Studio creates a snapshot. You cannot name it.

Volume licensing activation

MCS supports volume licensing activation to automate and manage the activation of Windows operating systems and Microsoft Office. The three models that MCS supports for volume licensing activation are:

- Key Management Service (KMS)
- Active Directory-based activation (ADBA)
- Multiple Activation Key (MAK)

You can change the activation setting after you create the machine catalog.

Key Management Service (KMS)

The KMS is a lightweight service that does not require a dedicated system and can easily be co-hosted on a system that provides other services. This functionality is supported on all Citrix supported Windows versions. During image preparation, MCS does the Microsoft Windows and Microsoft Office KMS rearm. You can skip rearm by running the command `Set-Provserviceconfigurationdata`. For more information on Microsoft Windows KMS Rearm and Microsoft Office KMS Rearm during image preparation, see [Machine Creation Services: Image Preparation Overview and Fault-Finding](#). For more information on KMS activation, see [Activate using Key Management Service](#).

Note:

All machine catalogs created after running the command `Set-Provserviceconfigurationdata` have the same setting as provided in the command.

Active Directory-based activation (ADBA)

ADBA enables you to activate machines through their domain connections. Machines are immediately activated when they join the domain. These machines remain activated as long as they remain joined to the domain and in contact with it. This functionality is supported on all Citrix supported Windows versions except Windows server 2022. For more information on Active directory-based activation, see [Activate using Active Directory-based activation](#).

Multiple Activation Key (MAK)

MAK is a way of activating volume and authenticating the Windows system with the help of the Microsoft server. You must buy the MAK key from Microsoft which is assigned with a fixed number of activation counts. Every time a Windows system is activated, the activation count reduces. There are two ways of activating the system:

- **Online Activation:** If the Windows system that you want to activate has internet access, the system automatically activates the Windows on installing the product key. This process reduces the activation count by 1 for the corresponding MAK.
- **Offline Activation:** If the Windows system is not able to connect to the internet to do the online activation, MCS gets a confirmation id and an installation id from the Microsoft server to get the Windows system activated. This way of activation is useful for non-persistent machine catalogs.

Key requirements

- The Delivery Controller must have internet access.
- Create a new catalog if the new image to be updated has a different MAK Key from the original.
- Install the MAK key on the master image. See [Deploy MAK Activation](#) for the steps to install MAK Key on a Windows System.
- If you are not using image preparation:
 1. Add the registry DWORD value `Manual` under `Computer\HKEY_LOCAL_MACHINE\SOFTWARE\Microsoft\Windows NT\CurrentVersion\SoftwareProtectionPlatform\Activation`.
 2. Set the value to 1.

Activation Counts To view the number of activations remaining for MAK Key or to check if a VM is consuming two or more activations, use the Volume Activation Management Tool (VAMT). See [Install VAMT](#).

Activate the Windows system using MAK To activate the Windows system using MAK:

1. Install the product key on the master image. This step consumes one activation count.
2. Create an MCS machine catalog.
3. If you aren't using image preparation:
 - a) Add the registry DWORD value `Manual` under `Computer\HKEY_LOCAL_MACHINE\SOFTWARE\Microsoft\Windows NT\CurrentVersion\SoftwareProtectionPlatform\Activation`.
 - b) Set the value to 1.

This method disables the option of online activation.

4. Add VMs to the machine catalog.
5. Power on the VMs.

6. Depending on whether it's online or offline activation, the Windows system is activated.
 - If the activation is online, the Windows system is activated after the product key is installed.
 - If the activation is offline, MCS communicates with provisioned VMs to get the activation status of the Windows system. MCS then retrieves a confirmation id and an installed id from the Microsoft server. These IDs are used to activate the Windows system.

Troubleshooting If the provisioned VM is not activated with the installed MAK Key, run `Get-ProvVM` or `Get-ProvScheme` command on a PowerShell window.

- The `Get-ProvScheme` command: See the parameter `WindowsActivationType` associated with the MCS machine catalog from the latest master image.
- The `Get-ProvVM` command. See the parameters `WindowsActivationType`, `WindowsActivationStatus`, `WindowsActivationStatusErrorCode`, and `WindowsActivationStatusError`.

You can check the error and verify the steps to resolve the issue.

Create a machine catalog using Web Studio

Before creating a catalog:

- Review this section to learn about the choices you make and the information you supply.
- Ensure that you have created a connection to the hypervisor, cloud service, and other resources that hosts your machines.
- If you have created a master image to provision machines, ensure that you have installed a VDA on that image.

To start the catalog creation wizard:

1. If this is the first catalog being created, you are guided to the correct selection (such as “Set up the machines and create machine catalogs to run apps and desktops”). The catalog creation wizard opens.
2. If you already created a catalog and want to create another, follow these steps:
 - a) Sign in to Web Studio, select **Machine Catalogs** in the left pane, and then select **Create Machine Catalog** in the action bar.
 - b) To organize catalogs using folders, create folders under the default **Machine Catalogs** folder. For more information, see [Create a catalog folder](#).
 - c) Select the folder where you want to create the catalog, and then click **Create Machine Catalog**. The catalog creation wizard opens.

The wizard walks you through the following items. The wizard pages that you see differ, depending on the selections you make.

Operating system

Each catalog contains machines of only one type. Select one.

- **Multi-session OS:** A multi-session OS catalog provides hosted shared desktops. The machines can be running supported versions of the Windows or Linux operating systems, but the catalog cannot contain both. (See the Linux VDA documentation for details about that OS.)
- **Single-session OS:** A single-session OS catalog provides VDI desktops that you can assign to various different users.
- **Remote PC Access:** A Remote PC Access catalog provides users with remote access to their physical office desktop machines. Remote PC Access does not require a VPN to provide security.

Machine management

This page does not appear when you are creating Remote PC Access catalogs.

The **Machine Management** page indicates how machines are managed and which tools you use to deploy machines.

Choose whether machines in the catalog are power managed through Web Studio.

- Machines are power managed through Web Studio, for example, VMs or blade PCs. This option is available only if you already configured a connection to a host.
- Machines are not power managed through Web Studio, for example, physical machines.

If you indicated that machines are power managed through Web Studio, choose which tool to use to create VMs.

- **Citrix Machine Creation Services (MCS):** Uses a master image to create and manage virtual machines. MCS is not available for physical machines.
- **Other:** A tool that manages machines already in the data center. Citrix recommends that you use Microsoft System Center Configuration Manager or another third-party application to ensure that the machines in the catalog are consistent.

Desktop types (desktop experience)

This page appears only when you are creating a catalog containing single-session OS machines.

The **Desktop Experience** page determines what occurs each time a user logs on. Select one of:

- Users connect to a new (random) desktop each time they log on.
- Users connect to the same (static) desktop each time they log on.

Image

This page appears only when you are using MCS to create VMs.

1. Select an image type for the machine catalog, and then select an image. Two image types are available:

- **Master image.** An image that has not yet gone through the image preparation process. The image preparation process is automatically initiated when catalog creation starts.

Note:

- When you are using MCS, do not run Sysprep on master images.
- If you specify a master image rather than a snapshot, Web Studio creates a snapshot, but you cannot name it.

- **Prepared image.** An image that has gone through the image preparation process and can be used for VM creation directly. Opting for prepared images rather than master images during catalog creation ensures faster and more reliable machine catalog creation, along with streamlined image lifecycle management.

Note:

- VMs created using prepared images don't support hibernation.
- Currently, creating catalogs using prepared images are available only in Azure and VMware environments.

For more information about how to create prepared images, see [Image management \(preview\)](#).

When selecting an image, you can add a note for the selected image if needed.

To enable use of the latest product features, ensure that the master image has the latest VDA version installed. Do not change the default minimum VDA selection. However, if you must use an earlier VDA version, see [VDA versions and functional levels](#).

An error message appears if you select a snapshot or VM that is not compatible with the machine management technology you selected earlier in the wizard.

2. To use an existing VM as the machine profile, select **Use a machine profile**, and then select the VM.

Note:

Currently, using machine profiles is restricted to Azure, AWS, GCP, and VMware VMs.

For VMware deployments, when creating a machine catalog using a machine profile, you must specify the folder where you want to keep the virtual machines.

To provide the virtual machine folder location, on the catalog creation wizard, go to **Virtual Machines** page, and go to **Select a folder to place the machines** section and select the virtual machine folder location. If not specified, the system considers the folder of the selected machine profile as the default location.

3. Select the minimum functional level for the catalog. To enable the use of the latest product features, ensure that the master image has the latest VDA version installed.

Machines

This page does not appear when you are creating Remote PC Access catalogs.

The title of this page depends on what you selected on the **Machine Management** page: **Machines**, **Virtual Machines**, or **VMs and users**.

When using MCS:

- Specify how many virtual machines to create. Enter **0** (zero) if you do not want to create any. Later, you can create VMs for an empty catalog by performing **Add machines**.
- Choose the amount of memory (in MB) each VM has.
- Each created VM has a hard disk. Its size is set in the master image. You cannot change the hard disk size in the catalog.
- If your deployment contains more than one zone, you can select a zone for the catalog.
- If you are creating static desktop VMs, select a virtual machine copy mode. See Virtual machine copy mode.
- If you are creating random desktop VMs that do not use vDisks, you can configure a cache to be used for temporary data on each machine. See Configure cache for temporary data.

When using other tools:

Add (or import a list of) Active Directory machine account names. You can change the Active Directory account name for a VM after you add/import it. If you specified static machines on the **Desktop Experience** page, you can optionally specify the Active Directory user name for each VM you add.

After you add or import names, you can use the **Remove** button to delete names from the list, while you are still on this page.

When using other tools (but not MCS):

An icon and tooltip for each machine added (or imported) help identify machines that might not be eligible to add to the catalog, or be unable to register with a Delivery Controller. For details, see VDA versions and functional levels.

Add SIDs while creating virtual machines

You can now add the parameter `ADAccountSid` to uniquely identify the machines while creating new virtual machines.

To do this:

1. Create a catalog with the supported identity type.
2. Add machines to the catalog using `NewProvVM`. For example:

```
1 New-ProvVM -ProvisioningSchemeName "name" -ADAccountSid @"SID "  
   ) -RunAsynchronously  
2 <!--NeedCopy-->
```

However, you cannot provision a machine with:

- An AD account that is not in the catalog identity pool
- An AD account that is not in available state

Virtual machine copy mode

The copy mode that you specify on the **Machines** page determines whether MCS creates thin (fast copy) or thick (full copy) clones from the master image. (Default = thin clones)

- Use fast copy clones for more efficient storage use and faster machine creation.
- Use full copy clones for better data recovery and migration support, with potentially reduced IOPS after the machines are created.

VDA versions and functional levels

A catalog's functional level controls which product features are available to machines in the catalog. Using features introduced in new product versions require a new VDA. Setting a functional level makes all features introduced in that version (and later, if the functional level does not change) available to machines in the catalog. However, machines in that catalog with an earlier VDA version cannot register.

A menu near the bottom of the **Machines** (or **Devices**) page allows you to select the minimum VDA level. This sets the catalog's minimum functional level. By default, the most current functional level is selected for on-premises deployments. If you follow the Citrix recommendation to always install and upgrade VDAs and core components to the latest version, you don't need to change this selection. However, if you must continue using older VDA versions, select the correct value.

A Citrix Virtual Apps and Desktops release might not include a new VDA version, or the new VDA does not impact the functional level. In such cases, the functional level might indicate a VDA version that

is earlier than the installed or upgraded components. Each release's [What's new](#) article indicates any change in the default functional level.

The selected functional level affects the list of machines above it. In the list, a tooltip next to each entry indicates whether the machine's VDA is compatible with the catalog at that functional level.

Messages are posted on the page if the VDA on each machine does not meet or exceed the minimum functional level selected. You can continue with the wizard. Those machines will likely not be able to register with a Controller later. Alternatively, you can:

- Remove the machines containing older VDAs from the list, upgrade their VDAs and then add them back to the catalog.
- Choose a lower functional level that prevents access to the latest product features.

A message is also posted if a machine was not be added to the catalog because it is the wrong machine type. Examples include attempting to add a server to a single-session OS catalog, or adding a single-session OS machine originally created for random allocation to a catalog of static machines.

Important:

At release 1811, an extra functional level was added: **1811 (or newer)**. That level is intended for use with future Citrix Virtual Apps and Desktops features. The **7.9 (or newer)** selection remains the default. That default is valid for all deployments now.

If you select **1811 (or newer)**, any earlier VDA versions in that catalog are unable to register with a Controller. However, if the catalog contains only VDAs at version 1811 or later supported versions, they are all eligible to register. This includes catalogs containing VDAs configured for later Citrix Virtual Apps and Desktops releases, including version 1903 and other 19XX releases before the current release.

Configure cache for temporary data

Caching temporary data locally on the VM is optional. You can enable use of the temporary data cache on the machine when you use MCS to manage pooled (not dedicated) machines in a catalog. If the catalog uses a connection that specifies storage for temporary data, you can enable and configure the temporary data cache information when you create the catalog.

Important:

This feature requires a current MCS I/O driver. Installing this driver is an option when you install or upgrade a VDA. By default, that driver is not installed.

You specify whether temporary data uses shared or local storage when you create the connection that the catalog uses. For more information, see [Connections and resources](#). To configure a cache for temporary data on each machine, you can use the following two options: **Memory allocated to cache**

(MB) and **Disk cache size (GB)**. By default, the two options are cleared. To enable the Memory allocated to cache (MB) option, select the Disk cache size (GB) check box. If the **Disk cache size** check box is not selected, the **Memory allocated to cache** option is grayed out. Depending on the connection type, the default values for these options might differ. Generally, the default values are sufficient for most cases. However, take into account the space needed for:

- Temporary data files created by Windows itself, including the Windows page file.
- User profile data.
- ShareFile data that is synced to users' sessions.
- Data that might be created or copied by a session user or any applications users might install inside the session.

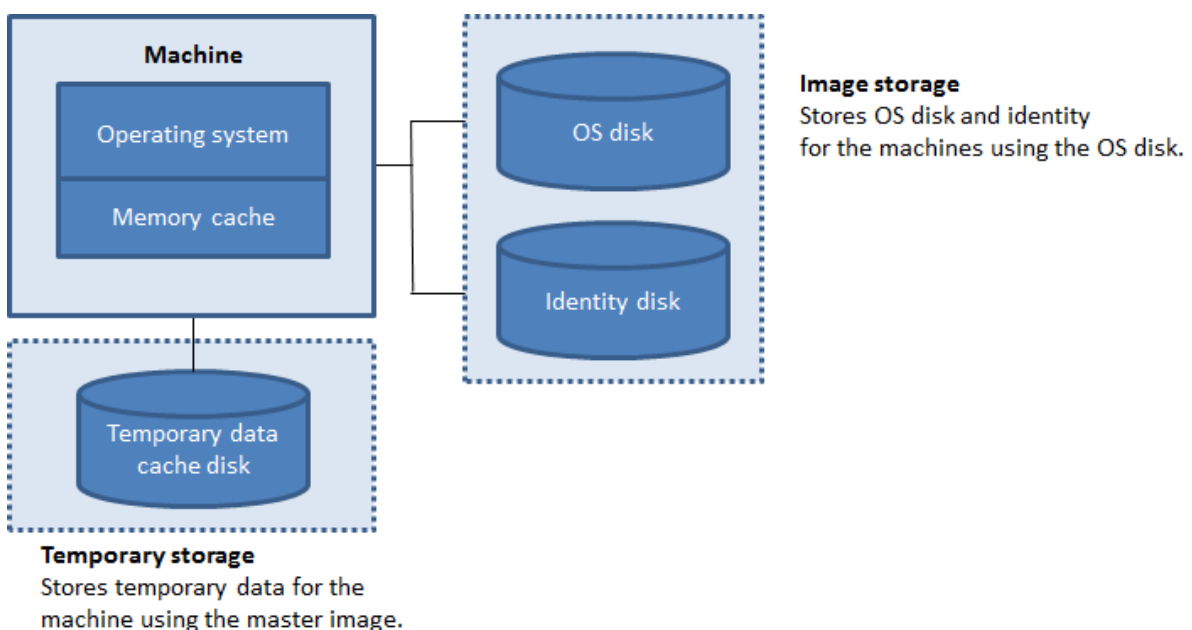

To configure a cache for temporary data on each machine, be aware of the following three scenarios:

- If you don't select the Disk cache size check box and the Memory allocated to the cache check box, temporary data is not cached. It is directly written to the difference disk (located in the OS storage) for each VM. (This is the provisioning action in version 7.8 and earlier.)
- If you select the Disk cache size check box and the Memory allocated to cache check box, temporary data is initially written to the memory cache. When the memory cache reaches its configured limit (the Memory allocated to cache value), the oldest data is moved to the temporary data cache disk.

Important:

- If the disk cache runs out of space, the user's session becomes unusable.
- This feature is not available when using a Nutanix host connection.

- You cannot change the cache values in a machine catalog after the machine is created.

Note:

- Configuring the write-back cache with only a disk cache and no memory cache has been deprecated. To enable a cache for temporary data, we recommend selecting both **Disk cache size (GB)** and **Memory allocated to cache (MB)** and specifying a size greater than 0 for the memory cache.
- The memory cache is part of the total amount of memory on each machine. Therefore, if you enable the Memory allocated to cache option, consider increasing the total amount of memory on each machine.
- Changing the Disk cache size from its default value can affect performance. The size must match user requirements and the load placed on the machine.

NIC

This page does not appear when you are creating Remote PC Access catalogs.

On the **Network Interface Cards** page, if you plan to use multiple NICs, associate a virtual network with each card. For example, you can assign one card to access a specific secure network, and another card to access a more commonly used network. You can also add or remove NICs from this page.

Machine accounts

This page appears only when creating Remote PC Access catalogs.

On the **Machine Accounts** page, specify the Active Directory machine accounts or Organizational Units (OUs) to add that correspond to users or user groups. Do not use a forward slash (/) in an OU name.

When adding OUs, you can do the following if the domain is not shown in the list:

- Search for it using an exact match.
- Browse all domains to find it.

You can choose a previously configured power management connection or elect not to use power management. If you want to use power management but a suitable connection hasn't been configured yet, you can create that connection later and then edit the machine catalog to update the power management settings.

Machine identities

This page appears only when using MCS to create VMs.

Each machine in the catalog must have a unique identity. This page lets you configure identities for machines in the catalog. The machines are joined to the identity after they are provisioned. You cannot change the identity type after you create the catalog.

A general workflow to configure settings on this page is as follows:

1. Select an identity from the list.
2. Indicate whether to create accounts or use existing ones, and the location (domain) for those accounts.

You can select one of the following options:

- **On-premises Active Directory.** Machines owned by an organization and signed into with an Active Directory account that belongs to that organization. They exist on-premises.
- **Hybrid Azure Active Directory joined.** Machines owned by an organization and signed into with an Active Directory Domain Services account that belongs to that organization. They exist in the cloud and on-premises. For information about the requirements, limitations, and considerations, see [Hybrid Azure Active Directory joined](#).

Note:

- Before you can use hybrid Azure Active Directory join, make sure that your Azure environment meets the prerequisites. See <https://docs.microsoft.com/en-us/azure/active-directory/devices/hybrid-azuread-join-managed-domains>.
- This option requires that the master image meets the operating system prerequisite. For more information, see the Microsoft documentation: <https://learn.microsoft.com/en-us/azure/active-directory/devices/concept-azure-ad-join-hybrid>.

Important:

- If you select **On-premises Active Directory** or **Hybrid Azure Active Directory joined** as the identity type, each machine in the catalog must have a corresponding Active Directory computer account.

If you create accounts, you must have permission to create computer accounts in the OU where the machines reside. Each machine in the catalog must have a unique name. Specify the account naming scheme for the machines that you want to create. For more information, see [Machine account naming scheme](#).

Note:

Make sure that OU names do not use forward slashes (/).

If you use existing accounts, browse to the accounts or click **Import** and specify a .csv file containing account names. The imported file content must use the format:

- [ADComputerAccount] ADcomputeraccountname.domain

Ensure that there are enough accounts for all the machines you are adding. The Web Studio interface manages those accounts. Therefore, either allow that interface to reset the passwords for all the accounts or specify the account password, which must be the same for all accounts.

For catalogs containing physical or existing machines, select or import existing accounts and assign each machine to both an Active Directory computer account and to a user account.

Machine account naming scheme

Each machine in a catalog must have a unique name. You must specify a machine account naming scheme when creating a catalog. Use wildcards (hash marks) as placeholders for sequential numbers or letters that appear in the name.

When specifying a naming scheme, be aware of the following rules:

- The naming scheme must contain at least one wildcard. You must put all wildcards together.
- The entire name, including wildcards, must contain at least 2 but no more than 15 characters. It must include at least one non-numeric and one # (wildcard) character.
- The name must not include spaces or any of the following characters: , ~ ! @ ' \$ % ^ & . () } { \ / * ? " < > | = + [] ; : _ " . .
- The name cannot end with a hyphen (-).

Also, leave enough room for growth when specifying the naming scheme. Consider this example: If you create 1,000 machine accounts with the scheme “veryverylong#”, the last account name created (veryverylong1000) contains 16 characters. Therefore, the naming scheme results in one or more machine names that exceed the maximum of 15 characters.

You can indicate whether the sequential values are numbers (0-9) or letters (A-Z):

- **0-9.** If selected, the specified wildcards resolve to sequential numbers.

Note:

If there is only one wildcard (#), the account names start with 1. If there are two, the account names start with 01. If there are three, the account names start with 001, and so on.

- **A-Z.** If selected, the specified wildcards resolve to sequential letters.

For example, a naming scheme of PC-Sales-## (with **0-9** selected) results in accounts named PC-Sales-01, PC-Sales-02, PC-Sales-03, and so on.

Optionally, you can specify what the account names start with.

- If you select **0-9**, accounts are named sequentially, starting with the specified numbers. Enter one or more digits, depending on how many wildcards you use in the preceding field. For example, if you use two wildcards, enter two digits or more.
- If you select **A-Z**, accounts are named sequentially, starting with the specified letters. Enter one or more letters, depending on how many wildcards you use in the preceding field. For example, if you use two wildcards, enter two letters or more.

Domain credentials

Select **Enter credentials** and enter the credentials of an administrator with permission to perform account operations in the target Active Directory domain.

Use the **Check name** option to check whether the user name is valid or unique. The option is useful, for example, when:

- The same user name exists in multiple domains. You are prompted to select the desired user.
- You can't remember the domain name. You can enter the user name without specifying the domain name. If the check passes, the domain name populates automatically.

Note:

If the identity type you selected in **Machine Identities** is **Hybrid Azure Active Directory joined**, the credentials you enter must have been granted the `Write userCertificate` permission.

Summary, name, and description

On the **Summary** page, review the settings you specified. Enter a name and description for the catalog. This information appears in Web Studio.

When you're done, click **Finish** to start the catalog creation.

When you're done, select **Finish** to start the catalog creation.

In **Machine Catalogs**, the new catalog appears with an inline progress bar.

To view details of the creation progress:

1. Hover the mouse over the machine catalog.
2. In the tooltip that appears, click **View details**.

A step-by-step progress graph appears where you can see the following:

- History of steps
- Progress and running time of the current step
- Remaining steps

MCS time synchronization

Time synchronization is determined by the master image and the type of machine identity joined catalog. You get the following time synchronization method according to the master image and the catalog:

Master image	Catalog	Resultant time synchronization method
NDJ	AD or Hybrid Azure AD	By default, NT5DS. You can disable MCS from changing time synchronization setting using registry settings in the master image
NDJ	NDJ or Azure AD	Same as the original time synchronization setting
AD or Hybrid Azure AD	AD or Hybrid Azure AD	Same as the original time synchronization setting
Azure AD	Azure AD	Same as the original time synchronization setting

Note:

The original time synchronization is controlled by the following registry setting and cannot be changed:

- Computer\HKEY_LOCAL_MACHINE\SYSTEM\CurrentControlSet\Services\W32Time\Config

Value: MaxAllowedPhaseOffset, MaxNegPhaseCorrection, and MaxPosPhaseCorrection

- Computer\HKEY_LOCAL_MACHINE\SYSTEM\CurrentControlSet\Services\W32Time\Parameters

Value: Type

To disable MCS from changing the time synchronization setting, set the value of the following registry setting in the master image:

- Computer\HKEY_LOCAL_MACHINE\SYSTEM\CurrentControlSet\Control\Citrix
- Name: TimeSyncMethodKeep
- Type: DWORD
- 0 (Or, value TimeSyncMethodKeep not configured): Does not keep the original time synchronization setting.
- 1: Keeps original time synchronization setting and default parameters values.

Important consideration about setting custom properties

Custom properties must be set correctly at `New-ProvScheme` and `Set-ProvScheme` in GCP and Azure environments. If you specify a non-existing custom property or properties, you get the following error message, and the commands fail to run.

- In Azure: `Invalid property found: <invalid property>`. Ensure that the `CustomProperties` parameter supports the property.
- In GCP: `Invalid property found: <invalid property>`. Ensure that the value supplied **for** the property is supported in the Hypervisor.

Troubleshoot

Important:

After creating the machine catalog using Web Studio, you can no longer use the `Get-ProvTask` PowerShell command to retrieve the tasks associated with machine catalog creation. This restriction is a result of Web Studio deleting those tasks after machine catalog creation regardless of whether the catalog is created successfully.

Citrix recommends collecting logs to help the Support team provide solutions. When using Citrix Provisioning, use the following procedure to generate log files:

1. On the master image, create the following registry key with the value of 1 (as a DWORD (32-bit value): `HKLM\Software\Citrix\MachineIdentityServiceAgent\LOGGING`.
2. Shut down the master image and create a snapshot.
3. On the Delivery Controller, run the following PowerShell command: `Set-ProvServiceConfiguration -Name ImageManagementPrep_NoAutoShutdown -Value $True`.
4. Create a catalog based on that snapshot.
5. When the preparation VM is created on the hypervisor, log in and extract the following files from the root of C:\: `Image-prep.log` and `PvsVmAgentLog.txt`.
6. Shut down the machine, at which point it reports the failure.
7. Run the following PowerShell command to re-enable auto shutdown of the image preparation machines: `Remove-ProvServiceConfigurationData -Name ImageManagementPrep_NoAutoShutdown`.

Image preparation issues

Because MCS creates many machines from a single image, some steps are performed to ensure that all machines are unique and correctly licensed. Image preparation is a part of the catalog creation

process. This preparation ensures that all provisioned machines have unique IP addresses and correctly announce themselves to the KMS server as unique instances. Within MCS, image preparation occurs after selecting the master image snapshot. A copy is made to enable the catalog to isolate itself from the selected machine. A *preparation* VM is created, based on the original VM, but with the network connection disconnected. Disconnecting the network connection prevents conflicts with other machines, while ensuring that the prepared VM is only attached to the newly copied disk.

A small *instruction* disk, containing the steps required to run the image preparation, is attached to the prepared VM. This prepared VM starts and the image preparation process begins. Image preparation includes the following processes:

- Enable DHCP. Enabling DHCP ensures that provisioned machines don't cause IP address conflicts. DHCP is enabled on all network cards.
- Microsoft Windows KMS Rearm. Rearming KMS ensures that Microsoft Windows is correctly licensed. The rearmed OS is invoked so it is correctly reported as a new instance to the KMS license server.
- Microsoft Office KMS Rearm (if Microsoft Office is installed). Rearming Microsoft Office ensures that any version of Microsoft Office (2010+) is registered correctly with their KMS server. Once Microsoft Office rearm is invoked, it reports as a new instance to the KMS license server.

Tip:

When the image preparation process finishes, the instruction disk is obtained from the hypervisor. The hypervisor contains the information gleaned from the image preparation process.

There are various reasons that the image preparation stage can fail. A failure message similar to the following appears: Image Preparation Office Rearm Failed.

These failures are discussed in the following sections.

Enable DHCP These failure cases are caused by network cards that do not support static IP addresses. For example, earlier versions of Dell SonicWall network cards. The operation failed as a SonicWall card is a firewall network card, so setting the card to DHCP makes no sense as that only supports DHCP. This was fixed later versions of Citrix Virtual Apps and Desktops. However, if it is seen on other types of network cards it must be reported to Citrix via the forums or your support contact.

Note:

This PowerShell setting in the following examples is applied to the Citrix Virtual Apps and Desktops site, so it affects all new catalogs and image updates performed to existing catalogs.

If you encounter this issue with other network cards, you can resolve it by running a PowerShell command on the Delivery Controller:

```
Set-ProvServiceConfigurationData -Name ImageManagementPrep_Excluded_Steps  
-Value EnabledHCP
```

Microsoft Office Rearm There are various KMS rearm failures that can happen during the Microsoft Office rearm stage. The main failures are:

- Some Microsoft Office runtimes, for example, **Access Runtime**, can invoke the Office rearm, causing it to fail.
- A KMS version of Microsoft Office is not installed.
- Rearm count exceeded.

If the error is a false positive, you can resolve it by running the following PowerShell command on the Delivery Controller:

```
Set-ProvServiceConfigurationData -Name ImageManagementPrep_Excluded_Steps  
-Value OfficeRearm
```

Microsoft Windows Rearm Various KMS failures can happen during the Microsoft Windows rearm stage. The main failures are:

- The version of Windows installed is not activated using KMS. For example, it uses a Multiple Activation Key (MAK).
- Rearm count exceeded.

If the version of Microsoft Windows is correctly licensed, you can clear OS rearm by running the following PowerShell command on the Delivery Controller:

```
Set-ProvServiceConfigurationData -Name ImageManagementPrep_Excluded_Steps  
-Value OsRearm
```

Instances of complete failure The image preparation machine is not connected to the network by design, this means that sometimes the image preparation stage can only report a complete failure. An example of this failure type resembles: Preparation of the Master VM Image failed. Make sure that the selected image has a supported OS (for example, Windows 7) and the correct version of the VDA (7.0 or later) installed.

The main reasons for a complete failure are:

Virtual Delivery Agent (VDA) is not installed, or VDA version 5.x is installed If the VDA 7.x is not installed on the master image, then image preparation times out after 20 minutes and reports the above error. This is because there is no software installed on the master image to run the image preparation stage and report success or failure. To resolve this, make sure the VDA (minimum version 7) is installed on the snapshot selected as the master image.

DISKPART SAN Policy The whole image preparation stage can fail due to the `DISKPART SAN` policy set on the master image. If it is not set to bring the image preparation instructions disk online, the machine is shut down and Image preparation reports a failure after 20 minutes. To check this on the master image run the following commands:

```
1 C:\> Diskpart.exe
2 DISKPART> San
3 <!--NeedCopy-->
```

This command returns the current policy. If it is not *Online All*, change it by running the following command:

```
DISKPART> San policy=OnlineAll
```

Shut down the master image, create a snapshot of that machine and then use that as the base MCS image.

If image preparation fails for another reason If image preparation is failing and there is no clear reason for failure, you can bypass the image preparation process when creating an MCS catalog. However, bypassing this process can cause issues with KMS licensing and networking (DHCP) on your site. Use the following PowerShell command:

```
1 Set-ProvServiceConfigurationData -Name
   ImageManagementPrep_DoImagePreparation -Value $false
2 <!--NeedCopy-->
```

Whenever possible, collect logs for the Citrix Support team. Either report the issue to Citrix via the forums or via your support contact. To collect logs:

1. On the master image create the following registry key with the value of 1 (as a “DWORD (32-bit value”): `HKLM\Software\Citrix\MachineIdentityServiceAgent\LOGGING`.
2. Shut down the master image and create a snapshot. On the Delivery Controller, start PowerShell, with the Citrix PowerShell snap-ins loaded, and run `Set-ProvServiceConfigurationData -Name ImageManagementPrep_NoAutoShutdown -Value $True`.
3. Create a catalog based on that snapshot.
4. When the preparation VM is created on the hypervisor, log in and extract from the root of C::

```
1 Image-prep.log
2 PvsVmAgentLog.txt
3 <!--NeedCopy-->
```

Shut the machine down. At this point it reports the failure.

Run from the following PowerShell command to re-enable auto shutdown of the image preparation machines:

```
Remove-ProvServiceConfigurationData -Name  
ImageManagementPrep_NoAutoShutdown
```

Where to go next

For information on creating specific cloud services catalogs, see:

- [Create an AWS catalog](#)
- [Create a XenServer catalog](#)
- [Create a Google Cloud Platform catalog](#)
- [Create a Microsoft Azure catalog](#)
- [Create a Microsoft System Center Virtual Machine Manager catalog](#)
- [Create a Nutanix catalog](#)
- [Create a VMware catalog](#)

If this is the first catalog created, Web Studio guides you to [create a delivery group](#).

To review the entire configuration process, see [Install and configure](#).

You can create a Citrix Provisioning catalog using the Full Configuration interface and PowerShell.

This implementation provides you the following advantages:

- A single unified console to manage both MCS and Citrix Provisioning catalogs.
- Have new features for Citrix Provisioning catalogs, such as, identity management solution, on-demand provisioning and so on.

Currently, this feature is available only for Azure workloads. For more information, see [Create Citrix Provisioning catalogs in Citrix Studio](#).

More information

- [Create and manage connections and resources](#)
- [Create catalogs of different join types](#)
- [Manage machine catalogs](#)

Create an AWS catalog

January 16, 2024

[Create machine catalogs](#) describes the wizards that create a machine catalog. The following information covers details specific to AWS virtualization environments.

Note:

Before creating an AWS catalog, you need to finish creating a connection to AWS. See [Connection to AWS](#).

Network setting during image preparation

During image preparation, a preparation virtual machine (VM) is created based on the original VM. This preparation VM is disconnected from the network. To disconnect the network from the preparation VM, a network security group is created to deny all inbound and outbound traffic. This network security group persists and is reused. The network security group's name is `Citrix.XenDesktop.IsolationGroup-GUID`, where GUID is randomly generated.

Configure AWS tenancy

AWS provides the following tenancy options:

- Shared tenancy (the default type): Multiple Amazon EC2 instances from different customers might reside on the same piece of physical hardware.
- Dedicated tenancy: Your EC2 instances run only on hardware with other instances that you have deployed. Other customers do not use the same piece of hardware.

You can use MCS to provision AWS dedicated hosts by using PowerShell.

Configure AWS dedicated host tenancy using PowerShell

You can create a catalog of machines with host tenancy defined through PowerShell.

An Amazon [EC2] dedicated host is a physical server with [EC2] instance capacity that is fully dedicated, allowing you to use existing per-socket, or per-VM software licenses.

Dedicated hosts have preset utilization based on instance type. For example, a single allocated dedicated host of C4 Large instance types is limited to running 16 instances. See the [AWS site](#) for more information.

The requirements for provisioning to AWS hosts include:

- An imported BYOL (bring your own license) image (AMI). With dedicated hosts, use and manage your existing licenses.
- An allocation of dedicated hosts with sufficient utilization to satisfy provisioning requests.
- enable **auto-placement**.

To provision to a dedicated host in AWS using PowerShell, use the **New-ProvScheme** cmdlet with the parameter `TenancyType` set to `Host`.

Refer to the [Citrix Developer Documentation](#) for more information.

Capture machine properties from AMIs

When you create a catalog to provision machines using Machine Creation Services (MCS) in AWS, you select an AMI to represent the master/golden image of that catalog. From that AMI, MCS uses a snapshot of the disk. In previous releases, if you wanted roles or tags on your machines you would use the AWS console to set them individually. This functionality is enabled by default.

Tip:

To use AWS instance property capturing, you must have a VM associated with the AMI.

To improve this process, **MCS reads** properties from the instance from which the AMI was taken and applies the Identity Access Management (IAM) role and tags of the machine to the machines provisioned for a given catalog. When using this optional feature, the catalog creation process finds the selected AMI source instance, reading a limited set of properties. These properties are then stored in an AWS Launch Template, which is used to provision machines for that catalog. Any machine in the catalog inherits the captured instance properties.

Captured properties include:

- IAM roles –applied to provisioned instances.
- Tags - applied to provisioned instances, their disk, and NICs. These tags are applied to transient Citrix resources, including: S3 bucket and objects, and AMIs, snapshots, and launch templates.

Tip:

The tagging of transient Citrix resources is optional and is configurable using the custom property `AwsOperationalResourcesTagging`.

Capture the AWS instance property

You can use this feature by specifying a custom property, `AwsCaptureInstanceProperties`, when creating a provisioning scheme for an AWS hosting connection:

```
New-ProvScheme -CustomProperties "AwsCaptureInstanceProperties,true"  
...<standard provscheme parameters
```

Refer to the [Citrix Developer Documentation](#) for more information.

Note:

The `AwsCaptureInstanceProperties` is deprecated. We recommend using machine profiles to specify machine properties for VMs instead.

Capture machine properties from machine profiles

When creating a catalog to provision AWS machines using MCS, you can use a machine profile to preset certain machine property settings.

To do so, follow these steps:

1. Store the machine profiles in the same availability zone as the resources where you are creating this catalog.
2. On the **Machine Template** page of the catalog creation wizard, select **Use a machine profile**. Machine profiles that are located in the same available zone as the resources you selected are shown.
3. Select a machine profile as needed.

Note:

You can use either a machine profile or an AMI to capture machine properties. In Web Studio, when you select **Use a machine profile**, the **Apply machine template properties to virtual machines** option is automatically hidden.

Tag AWS operational resource

When creating a catalog to provision machines in AWS by using MCS, you can control whether to apply the IAM role and tag properties to those machines. You can also control whether to apply machine tags to operational resources.

An Amazon Machine Image (AMI) represents a type of virtual appliance used to create a virtual machine within the Amazon Cloud environment, commonly referred to as EC2. You use an AMI to deploy services that use the EC2 environment. When you create a catalog to provision machines using MCS for AWS, you select the **AMI** to act as the golden image for that catalog.

Important:

Creating catalogs by capturing an instance property and a launch template is required for using operational resource tagging.

To create an AWS catalog, you must first create an AMI for the instance you want to be the golden image. MCS reads the tags from that instance and incorporates them into the launch template. The launch template tags are then applied to all Citrix resources created in your AWS environment, including:

- Virtual Machines
- VM disks
- VM network interfaces
- S3 buckets
- S3 objects
- Launch templates
- AMIs

Tag an operational resource

To use PowerShell to tag resources:

1. Open a PowerShell window from the DDC host.
2. Run the command `asnp citrix` to load Citrix-specific PowerShell modules.

To tag a resource for a provisioned VM, use the new custom property `AwsOperationalResourcesTagging`. The syntax for this property is:

```
New-ProvScheme -CustomProperties "AwsCaptureInstanceProperties,true;
AwsOperationalResourcesTagging,true"...<standard provscheme parameters
>
```

Where to go next

- If this is the first catalog created, Web Studio guides you to [create a delivery group](#)
- To review the entire configuration process, see [Install and configure](#)
- To manage catalogs, see [Manage machine catalogs](#) and [Manage an AWS catalog](#)

Copy tags on VMs

You can copy tags on NICs, and disks (Identity disk, write back cache disk, and OS disk) that are specified in the machine profile to newly created VMs in an MCS machine catalog. You can specify these tags in any of the machine profile sources (AWS VM instance or AWS launch template version). This feature is applicable to persistent and non-persistent machine catalogs and VMs.

Note:

- On AWS EC2 console, you cannot see **Tag Network Interfaces** values under the **Launch Template Version Resource Tags**. However, you can run the PowerShell command `aws ec2 describe-launch-template-versions --launch-template-id lt-0bb652503d45dcbcd --versions 12` to see the tag specifications.

- If a machine profile source (VM or launch template version) has two network interfaces (eni-1 and eni-2), and eni-1 has tag t1 and eni-2 has tag t2, then the VM gets both the two network interfaces' tags.

Create a catalog using a machine profile

When you create a catalog to provision machines using Machine Creation Services (MCS) in AWS, you can now use a machine profile to capture the hardware properties from an EC2 instance (VM) or launch template version and apply them to the provisioned machines. Properties that are captured can include, for example, EBS volume properties, instance type, EBS optimization, and other supported AWS configurations. When editing the catalog, the machine profile of the provisioned machines can be changed by providing a different VM or launch template.

Note:

EBS volume properties are derived only from a machine profile.

Important considerations

The important considerations while creating an MCS machine catalog:

- If you add machine hardware property parameters in the `New-ProvScheme` and `Set-ProvScheme` commands, then the values provided in the parameters overwrite the values in the machine profile.
- If you set `AwsCaptureInstanceProperties` as `true` and do not set `MachineProfile` property, then only IAM roles and tags are captured.
- You cannot set both `AwsCaptureInstanceProperties` and `MachineProfile` at the same time.

****Note:**

The `AwsCaptureInstanceProperties` is deprecated.

- You must explicitly provide the values of the following properties:
 - TenancyType
 - Security Group
 - NIC or Virtual Network
- You can enable `AwsOperationalResourcesTagging` only if you enable `AwsCaptureInstancePro` or specify a machine profile.

The important considerations after creating an MCS machine catalog:

- Only the new VMs added to the catalog are affected by the change.
- You cannot change a catalog from machine profile-based to non-machine profile-based catalog.

Create a machine catalog using a machine profile

To create a machine catalog using a machine profile:

1. Open a **PowerShell** window.
2. Run `asnp citrix*` to load the Citrix-specific PowerShell modules.
3. Create an identity pool if not already created. For example,

```
1 New-AcctIdentityPool -IdentityPoolName idPool -NamingScheme ms## -
  Domain abcdf -NamingSchemeType Numeric
2 <!--NeedCopy-->
```

4. Run `New-ProvScheme` command. For example:

```
1 New-ProvScheme -ProvisioningSchemeName demet-test-1
2 -HostingUnitUid aa633238-9xxd-4cf6-80e8-232a758a1xx1
3 -IdentityPoolUid 34d5b088-e312-416f-907d-16573xxxxxc4
4 -CleanOnBoot
5 -MasterImageVM 'XDHyp:\HostingUnits\cvad-test-scalestress\citrix-
  demet-ami.0 (ami-0ca813xxxxxx061ef).template'
6 -MachineProfile 'XdHyp:\HostingUnits\cvad-test-scalestress\us-east-
  -1a.availabilityzone\machine-profile-instance i (i-0xxxxxxx).
  vm'
7 <!--NeedCopy-->
```

5. Complete creating the catalog. For more information, see [Citrix PowerShell SDK](#).

To update the machine profile on a catalog that was initially provisioned with a machine profile:

1. Run `Set-ProvScheme` command. For example,

```
1 Set-ProvScheme `
2 -ProvisioningSchemeUid "<ID" `
3 -MachineProfile "XDHyp:\HostingUnits\abc\us-east-1a.
  availabilityzone\citrix-cvad-machineprofile-instance (i-0
  xxxxxxxx).vm"
4 <!--NeedCopy-->
```

Create a catalog with launch template version

You can create an MCS machine catalog with a launch template version as a machine profile input. You can also update the input of a machine profile catalog from a VM to a launch template version and from a launch template version to a VM.

On the AWS EC2 console, you can provide the instance configuration information of a launch template along with version number. When you specify the launch template version as a machine profile input while creating or updating a machine catalog, the properties from that version of the launch template are copied to the provisioned VDA VMs.

The following properties can be provided using machine profile input or explicitly as parameters in `New-ProvScheme` or `Set-ProvScheme` commands. If they are provided in `New-ProvScheme` or `Set-ProvScheme` commands, they take precedence over the machine profile values of these properties.

- Service Offering
- Networks
- Security Groups
- Tenancy Type

Note:

If service offering is not provided in the machine profile launch template or as a parameter in the `New-ProvScheme` command, you get an appropriate error.

To create a catalog using launch template version as a machine profile input:

1. Open a **PowerShell** window.
2. Run `asnp citrix*` to load the Citrix-specific PowerShell modules.
3. Get the list of launch template versions of a launch template. For example:

```
1 XDHyp:\HostingUnits\test\test-mp-sard (lt-01xxxxx).launchtemplate>
  ls | Select FullPath
2 <!--NeedCopy-->
```

4. Create an identity pool if not created. For example:

```
1 New-AcctIdentityPool `
2 -IdentityPoolName "abc11" `
3 -NamingScheme "abc1-##" `
4 -NamingSchemeType Numeric `
5 -Domain "citrix-xxxxxx.local" `
6 -ZoneUid "xxxxxxxx" `
7 <!--NeedCopy-->
```

5. Create a provisioning scheme with a launch template version as a machine profile input. For example:

```
1 New-ProvScheme `
2 -ProvisioningSchemeName "MPLT1" `
3 -HostingUnitUid "c7f71f6a-3f45-4xxx-xxxx-xxxxxxxxxx" `
4 -IdentityPoolUid "bf3a6ba2-1f80-4xxx-xxxx-xxxxxxxxxx" `
```

```

5 -MasterImageVM "XDHyp:\HostingUnits\xxxx-ue1a\apollo-non-
  persistent-vda-win2022 (ami-0axxxxxxxxxxxx).template" `
6 -CleanOnBoot `
7 -MachineProfile "XDHyp:\HostingUnits\xxxx-ue1a\machineprofiletest
  (lt-01xxxx).launchtemplate\lt-01xxxx (1).
  launchtemplateversion"
8 <!--NeedCopy-->

```

You can also override parameters like service offering, security groups, tenancy, and networks. For example:

```

1 New-ProvScheme `
2 -ProvisioningSchemeName "MPLT1" `
3 -HostingUnitUid " c7f71f6a-3f45-4xxx-xxxx-xxxxxxxxxxx" `
4 -IdentityPoolUid " bf3a6ba2-1f80-4xxx-xxxx-xxxxxxxxxxx" `
5 -MasterImageVM "XDHyp:\HostingUnits\xxxx-ue1a\apollo-non-
  persistent-vda-win2022 (ami-0axxxxxxxxxxxx).template" `
6 -CleanOnBoot `
7 -MachineProfile "XDHyp:\HostingUnits\xxxx-ue1a\machineprofiletest
  (lt-01xxxx).launchtemplate\lt-01xxxx (1).launchtemplateversion"
8 -ServiceOffering "XDHyp:\HostingUnits\xxxx-ue1a\T3 Large Instance.
  serviceoffering"
9 <!--NeedCopy-->

```

6. Register provisioning scheme as a broker catalog. For example:

```

1 New-BrokerCatalog -Name "MPLT1" `
2 -AllocationType Random `
3 -Description "Machine profile catalog" `
4 -ProvisioningSchemeId fe7df345-244e-4xxx-xxxxxxxxxxx `
5 -ProvisioningType Mcs `
6 -SessionSupport MultiSession `
7 -PersistUserChanges Discard
8 <!--NeedCopy-->

```

7. Complete creating the catalog. For more information, see [Citrix PowerShell SDK](#)

You can also update the input of a machine profile catalog from a VM to a launch template version and from a launch template version to a VM. For example:

- To update the input of a machine profile catalog from a VM to a launch template version:

```

1 Set-ProvScheme -ProvisioningSchemeName "CloudServiceOfferingTest"
2 -MachineProfile "XDHyp:\HostingUnits\xxxx-ue1a\machineprofiletest
  (lt-0bxxxxxxxxxxxx).launchtemplate\lt-0bxxxxxxxxxxxx (1).
  launchtemplateversion"
3 <!--NeedCopy-->

```

- To update the input of a machine profile catalog from a launch template version to a VM:

```

1 Set-ProvScheme -ProvisioningSchemeName "CloudServiceOfferingTest"
2 -MachineProfile "XDHyp:\HostingUnits\sard-ue1a\us-east-1a.
   availabilityzone\apollo-non-persistent-vda-win2022-2 (i-08
   xxxxxxxx).vm"
3 <!--NeedCopy-->

```

Filter VM instances

An AWS EC2 instance that you use as a machine profile VM must be compatible for the machine catalog to create and function correctly. To list the AWS EC2 instances that can be used as machine profile input VMs, you can use the `Get-HypInventoryItem` command. The command can page and filter the inventory of VMs available on a hosting unit.

Pagination:

`Get-HypInventoryItem` supports two modes of pagination:

- Paging mode uses the `-MaxRecords` and `-Skip` parameters to return sets of items:
 - `-MaxRecords`: The default is **1**. This controls how many items to return.
 - `-Skip`: The default is **0**. This controls how many items to skip from the absolute beginning (or absolute end) of the list in the hypervisor.
- Scrolling mode uses `-MaxRecords`, `-ForwardDirection`, and `-ContinuationToken` parameters to allow scrolling of the records:
 - `-ForwardDirection`: The default is **True**. This is used along with `-MaxRecords` to return either the next set of matching records or the previous set of matching records.
 - `-ContinuationToken`: The returns the items immediately after (or before if `ForwardDirection` is **false**) but not including the item given in the `ContinuationToken`.

Examples of pagination:

- To return a single record of the machine template with the lowest name. The `AdditionalData` field has the `TotalItemsCount` and the `TotalFilteredItemsCount`:

```

1 Get-HypInventoryItem -LiteralPath "XDHyp:\HostingUnits\ctx-test"
   -ResourceType template
2 <!--NeedCopy-->

```

- To return 10 records of the machine template with the lowest name:

```

1 Get-HypInventoryItem -LiteralPath "XDHyp:\HostingUnits\ctx-test"
   -ResourceType template -MaxRecords 10 | select Name
2 <!--NeedCopy-->

```

- To return an array of records ending with the highest name:

```
1 Get-HypInventoryItem -LiteralPath "XDHyp:\HostingUnits\ctx-test"
  -ResourceType template -ForwardDirection $False -MaxRecords 10
  | select Name
2 <!--NeedCopy-->
```

- To return an array of records starting at the machine template associated with the given ContinuationToken:

```
1 Get-HypInventoryItem -LiteralPath "XDHyp:\HostingUnits\ctx-test"
  -ResourceType template -ContinuationToken "ami-07xxxxxxxxxx" -
  MaxRecords 10
2 <!--NeedCopy-->
```

Filtering:

The following additional optional parameters are supported for filtering. You can combine these parameters with the pagination options.

- `-ContainsName "my_name"`: If the given string matches part of an AMI name, then the AMI is included in the `Get` result. For example:

```
1 Get-HypInventoryItem -LiteralPath "XDHyp:\HostingUnits\ctx-test"
  -ResourceType template -MaxRecords 100 -ContainName 'apollo'
  | select Name
2 <!--NeedCopy-->
```

- `-Tags '{ "Key0": "Value0", "Key1": "Value1", "Key2": "Value2" } '`: If an AMI has at least one of these tags, it is included in the `Get` result. For example:

```
1 Get-HypInventoryItem -LiteralPath "XDHyp:\HostingUnits\ctx-test"
  -ResourceType template -MaxRecords 100 -Tags '{
2 "opex owner": "Not tagged" }
3 ' | select Name
4 <!--NeedCopy-->
```

Note:

Two tag values are supported. **Not Tagged** tag value matches items which do not have the given tag in their list of tags. **All values** tag value matches items which have the tag regardless of the value of the tag. Otherwise, the match happens only if the item has the tag and the value equals to what is given in the filter.

- `-Id "ami-0a2d913927e0352f3"`: If the AMI matches the given ID, it is included in the `Get` result. For example:

```
1 Get-HypInventoryItem -LiteralPath "XDHyp:\HostingUnits\ctx-test"
  -ResourceType template -Id ami-xxxxxxxxxxxxx
2 <!--NeedCopy-->
```

Filtering on AdditionalData parameter:

The `AdditionalData` filter parameter lists templates or VMs based on their capability, service offering, or any property which is in `AdditionalData`. For example:

```
1 (Get-HypInventoryItem -ResourceType "launchtemplateversion" -
   LiteralPath "XDHyp:\HostingUnits\aws" -MaxRecords 200).
   AdditionalData
2 <!--NeedCopy-->
```

You can also add a `-Warn` parameter to indicate the incompatible VMs. The VMs are included with an `AdditionalData` field named **Warning**. For example:

```
1 (Get-HypInventoryItem -ResourceType "launchtemplateversion" -
   LiteralPath "XDHyp:\HostingUnits\aws" -MaxRecords 200 -Template "ami
   -015xxxxxxxxxx" -Warn $true).AdditionalData
2 <!--NeedCopy-->
```

More information

- [Create and manage connections and resources](#)
- [Connection to AWS](#)
- [Create machine catalogs](#)

Create a XenServer catalog

November 9, 2023

[Create machine catalogs](#) describes the wizards that create a machine catalog. The following information covers details specific to XenServer virtualization environments.

Note:

Before creating a XenServer catalog, you need to finish creating a connection to XenServer. See [Connection to XenServer](#).

Create a machine catalog using a XenServer connection

GPU-capable machines require a dedicated master image. Those VMs require video card drivers that support GPUs. Configure GPU-capable machines to allow the VM to operate with software that uses the GPU for operations.

1. In XenCenter, create a VM with standard VGA, networks, and vCPU.

2. Update the VM configuration to enable GPU use (either Passthrough or vGPU).
3. Install a supported operating system and enable RDP.
4. Install Citrix VM Tools and NVIDIA drivers.
5. Clear the Virtual Network Computing (VNC) Admin Console to optimize performance, and then restart the VM.
6. You are prompted to use RDP. Using RDP, install the VDA and then restart the VM.
7. Optionally, create a snapshot for the VM as a baseline template for other GPU master images.
8. Using RDP, install customer-specific applications that are configured in XenCenter and use GPU capabilities.

Limitations

- If a Citrix Virtual Apps and Desktops deployment with its VMs hosted on Citrix Hypervisor 8.2 uses multiple GFS2 SRs in a single MCS catalog, the VMs in the catalog cannot access the VDIs during deployment. The error “VDI is currently in use” is reported.
- XenServer doesn’t support MCS full clone VMs with GFS2 SRs.

For more information, see [Constraints](#).

Create a machine catalog using a machine profile

When you create a catalog to provision machines using MCS, you can use a machine profile to capture the hardware properties from a virtual machine and apply them to newly provisioned VMs in the catalog. If the `MachineProfile` parameter is not used, the hardware properties are captured from the master image VM or snapshot.

Note:

Currently, you can use only a VM as a machine profile input.

You can explicitly configure the following parameters to overwrite the values of the parameters in the machine profile input:

- `VMCpuCount`
- `VMMemory`
- `NetworkMapping`

To create a catalog with a machine profile:

1. Open the PowerShell window.
2. Run `asnp citrix*`.

3. Create an identity pool. The identity pool is a container for the Active Directory (AD) accounts for the VMs to be created. For example:

```
1 New-AcctIdentityPool -Domain "citrix-xxxxxx.local" -
  IdentityPoolName "ExampleIdentityPool" -NamingScheme "abc1-##"
  -NamingSchemeType "Numeric" -Scope @() -ZoneUid "xxxxxxx"
2 <!--NeedCopy-->
```

4. Create the required AD computer accounts in Active Directory.

```
1 $password = "password123" | ConvertTo-SecureString -AsPlainText -
  Force
2 New-AcctADAccount -IdentityPoolName "ExampleIdentityPool" -Count
  10 -ADUserName "citrix-xxxxxx\admin1" -ADPassword $password
3 Set-AcctAdAccountUserCert -IdentityPoolName "ExampleIdentityPool"
  -ADUserName "citrix-xxxxxx\admin1" -ADPassword $password
4 <!--NeedCopy-->
```

5. Run the `New-ProvScheme` command to create a catalog. For example:

```
1 New-ProvScheme -CleanOnBoot -HostingUnitName "ExampleHostingUnit"
  -IdentityPoolName "ExampleIdentityPool" -InitialBatchSizeHint 2
  -CustomProperties '<CustomProperties xmlns="http://schemas.
  citrix.com/2014/xd/machinecreation" xmlns:xsi="http://www.w3.
  org/2001/XMLSchema-instance">
2 <Property xsi:type="StringProperty" Name="UseManagedDisks" Value="
  true" />
3 </CustomProperties>'
4 -MasterImageVM "XDHyp:\HostingUnits\ExampleHostingUnit\ExampleVDA.
  vm\ExampleVDA.snapshot" -ProvisioningSchemeName "ExampleCatalog
  " -Scope @() -SecurityGroup @()
5 -MachineProfile "XDHyp:\HostingUnits\ExampleHostingUnit\
  ExampleMachineProfile.vm"
6 <!--NeedCopy-->
```

6. Register provisioning scheme as a broker catalog. For example:

```
1 $ConfigZone = Get-ConfigZone | Where-Object {
2   $_.Name -eq "xxxxxx" }
3
4 New-BrokerCatalog -Name "MPLT1" -AllocationType Random -
  Description "Machine profile catalog" -ProvisioningSchemeId
  fe7df345-244e-4xxxx-xxxxxxx -ProvisioningType Mcs -
  SessionSupport MultiSession -PersistUserChanges Discard -
  ZoneUid ($ConfigZone.Uid)
5 <!--NeedCopy-->
```

7. Add VMs to the catalog.

To update a catalog with a new machine profile:

1. Run the `Set-ProvScheme` command. For example:

```
1 Set-ProvScheme -ProvisioningSchemeName "ExampleCatalog" -  
  MachineProfile "XDHyp:\HostingUnits\ExampleHostingUnit\  
  ExampleMachineProfileVm.vm\ExampleMachineProfileSnapshot.  
  snapshot"  
2 <!--NeedCopy-->
```

For more information on the Set-ProvScheme command, see [Set-ProvScheme](#).

Note:

- The `Set-ProvScheme` command in this case does not change the machine profile of the existing VMs in the catalog. Only the newly created VMs added to the catalog have the new machine profile.
- You cannot convert a machine profile-based machine catalog to non-machine profile-based machine catalog.

Where to go next

- If this is the first catalog created, Web Studio guides you to [create a delivery group](#)
- To review the entire configuration process, see [Install and configure](#)
- To manage catalogs, see [Manage machine catalogs](#) and [Manage a XenServer catalog](#)

More information

- [Create and manage connections and resources](#)
- [Connection to XenServer](#)
- [Create machine catalogs](#)

Create a Google Cloud Platform catalog

April 15, 2024

[Create machine catalogs](#) describes the wizards that create a machine catalog. The following information covers details specific to Google cloud environments.

Note:

Before creating a Google cloud platform (GCP) catalog, you need to finish creating a connection to GCP. See [Connection to Google cloud environments](#).

Prepare a master VM instance and a persistent disk

Tip:

Persistent disk is the Google Cloud term for virtual disk.

To prepare your master VM instance, create and configure a VM instance with properties that match the configuration you want for the cloned VDA instances in your planned machine catalog. The configuration does not apply only to the instance size and type. It also includes instance attributes such as metadata, tags, GPU assignments, network tags, and service account properties.

As part of the mastering process, MCS uses your master VM instance to create the Google Cloud *instance template*. The instance template is then used to create the cloned VDA instances that comprise the machine catalog. Cloned instances inherit the properties (except the VPC, subnet, and persistent disk properties) of the master VM instance from which the instance template was created.

After configuring the properties of the master VM instance to your specifics, start the instance and then prepare the persistent disk for the instance.

We recommend that you manually create a snapshot of the disk. Doing so lets you use a meaningful naming convention to track versions, gives you more options to manage earlier versions of your master image, and saves time for machine catalog creation. If you do not create your own snapshot, MCS creates a temporary snapshot for you (which is deleted at the end of the provisioning process).

Create a machine catalog

You can create a machine catalog in two ways:

- [Create a machine catalog using Web Studio](#)
- [Create a machine catalog using PowerShell](#)

Create a machine catalog using Web Studio

Note:

Create your resources before you create a machine catalog. Use the naming conventions established by Google Cloud when configuring machine catalogs. See [Bucket and object naming guidelines](#) for more information.

Follow the guidance in [Create machine catalogs](#). The following description is unique to Google Cloud catalogs.

1. Sign in to Web Studio and select **Machine Catalogs** in the left pane.
2. Select **Create Machine Catalog** in the action bar.

3. On the **Operating System** page, select **Multi-session OS** and then select **Next**.
 - Citrix Virtual Apps and Desktops also supports single-session OS.
4. On the **Machine Management** page, select the **Machines that are power managed** and the **Citrix Machine Creation Services** options and then select **Next**. If there are multiple resources, select one from the menu.
5. On the **Image** page, complete these steps as needed, and then click **Next**.
 - a) Select a snapshot or VM as the master image. If you want to use the sole tenancy functionality, be sure to select an image whose node group property is correctly configured. See [Enable zone selection](#).
 - b) To use an existing VM as the machine profile, select Use a machine profile, and then select the VM.

Note:

Currently, VMs in this catalog inherit the Disk encryption set ID, Machine size, Storage type, and Zone settings from the machine profile.

- c) Select the minimum functional level for the catalog. To use the sole tenancy functionality, be sure to select an image whose node group property is correctly configured.
6. On the **Storage Types** page, select the type of storage used to contain the operating system for this machine catalog. Each of the following storage options has unique price and performance characteristics. (An identity disk is always created using the zonal standard persistent disk.)
 - Standard persistent disk
 - Balanced persistent disk
 - SSD persistent disk

For details about Google Cloud storage options, see <https://cloud.google.com/compute/docs/disks/>.

7. On the **Virtual Machines** page, specify how many VMs you want to create, view the detailed specification of the VMs, and then select **Next**. If you use sole tenant node groups for machine catalogs, be sure to select **only** the zones where reserved sole tenant nodes are available. See [Enable zone selection](#).
8. On the **Computer Accounts** page, select an Active Directory account and then select **Next**.
 - If you select **Create new Active Directory accounts**, select a domain and then enter the sequence of characters representing the naming scheme for the provisioned VM computer accounts created in the Active Directory. The account naming scheme can contain 1–64 characters, and cannot contain blank spaces, or non-ASCII or special characters.

- If you select **Use existing Active Directory accounts**, select **Browse** to navigate to the existing Active Directory computer accounts for the selected machines.
9. On the **Domain Credentials** page, select **Enter credentials**, type the user name and password, select **Save**, and then select **Next**.
 - The credential you type must have permissions to perform Active Directory account operations.
 10. On the **Summary** page, confirm the information, specify a name for the catalog, and then select **Finish**.

Note:

Starting with version 2402, GCP catalog names must comply with these rules:

- Start with a lowercase letter.
- Include only lowercase letters (a-z), numbers, and hyphens.
- End with either a lowercase letter or a number.

When you attempt to rename existing GCP catalogs that don't comply with these rules, error messages appear and guide you to rename them according to the updated rules.

Machine catalog creation might take a long time to complete. To verify that the machines are created on the target node groups, go to the Google Cloud console.

Import manually created Google Cloud machines

You can *create a connection to Google Cloud* and then *create a catalog containing Google Cloud machines*. Then, you can manually power cycle Google Cloud machines through Citrix Virtual Apps and Desktops. With this feature, you can:

- Import manually created Google Cloud multi-session OS machines into a Citrix Virtual Apps and Desktops machine catalog.
- Remove manually created Google Cloud multi-session OS machines from a Citrix Virtual Apps and Desktops catalog.
- Use existing Citrix Virtual Apps and Desktops power management capabilities to power manage Google Cloud Windows multi-session OS machines. For example, set a restart schedule for those machines.

This functionality does not require changes to an existing Citrix Virtual Apps and Desktops provisioning workflow, nor the removal of any existing feature. We recommend that you use MCS to provision machines in Web Studio instead of importing manually created Google Cloud machines.

Shared Virtual Private Cloud

Shared Virtual Private Clouds (VPCs) comprise a host project, from which the shared subnets are made available, and one or more service projects that use the resource. Shared VPCs are desirable options for larger installations because they provide centralized control, usage, and administration of shared corporate Google cloud resources. For more information, see the [Google Documentation site](#).

With this feature, Machine Creation Services (MCS) supports provisioning and managing machine catalogs deployed to Shared VPCs. This support, which is functionally equivalent to the support currently provided in local VPCs, differs in two areas:

1. You must grant extra permissions to the Service Account used to create the Host Connection. This process allows MCS to access and use Shared VPC Resources.
2. You must create two firewall rules, one each for ingress and egress. These firewall rules are used during the image mastering process.

New permissions required

A Google Cloud service account with specific permissions is required when creating the host connection. These additional permissions must be granted to any service accounts used to create Shared VPC based host connections.

Tip:

These additional permissions are not new to Citrix Virtual Apps and Desktops. They are used to facilitate the implementation of local VPCs. With Shared VPCs, these additional permissions allow access to other shared VPC resources.

A maximum of four extra permissions must be granted to the service account associated with the host connection to support Shared VPC:

1. **compute.firewalls.list** - This permission is mandatory. It allows MCS to retrieve the list of firewall rules present on the Shared VPC.
2. **compute.networks.list** - This permission is mandatory. It allows MCS to identify the Shared VPC networks available to the service account.
3. **compute.subnetworks.list** - This permission is optional depending on how you use VPCs. It allows MCS to identify the subnets within the visible Shared VPCs. This permission is already required when using local VPCs but must also be assigned in the Shared VPC host project.
4. **compute.subnetworks.use** - This permission is optional depending on how you use VPCs. It is necessary to use subnet resources in the provisioned machine catalogs. This permission is already required for using local VPCs but must also be assigned in the Shared VPC host project.

When using these permissions, consider that there are different approaches based on the type of permission used to create the machine catalog:

- Project-level permission:
 - Allows access to all Shared VPCs within the host project.
 - Requires the permissions #3 and #4 must be assigned to the service account.
- Subnet-level permission:
 - Allows access to specific subnets within the Shared VPC.
 - Permissions #3 and #4 are intrinsic to the subnet level assignment and therefore do not need to be assigned directly to the service account.

Select the approach that matches your organizational needs and security standards.

Tip:

For more information about the differences between project-level and subnet-level permissions, see the [Google Cloud documentation](#).

Firewall Rules

During the preparation of a machine catalog, a machine image is prepared to serve as the master image system disk for the catalog. When this process occurs, the disk is temporarily attached to a virtual machine. This VM must run in an isolated environment that prevents all inbound and outbound network traffic. This is accomplished through a pair of deny-all firewall rules; one for ingress and one for egress traffic. When using Google Cloud local VCPs, MCS creates this firewall in the local network and applies it to the machine for mastering. After mastering completes, the firewall rule is removed from the image.

We recommend keeping the number of new permissions required to use Shared VPCs to a minimum. Shared VPCs are higher-level corporate resources and typically have more rigid security protocols in place. For this reason, create a pair of firewall rules in the host project on the shared VPC resources, one for ingress and one for egress. Assign the highest priority to them. Apply a new target tag to each of these rules, using the following value:

```
citrix-provisioning-quarantine-firewall
```

When MCS creates or updates a machine catalog, it searches for firewall rules containing this target tag. It then examines the rules for correctness and applies them to the machine used to prepare the master image for the catalog. If the firewall rules are not found, or the rules are found but the rules or their priorities are incorrect, a message similar to the following appears:

```
"Unable to find valid INGRESS and EGRESS quarantine firewall rules for VPC <name> in project <project>. "Please ensure you have created 'deny all' firewall rules with the network tag 'citrix-provisioning-quarantine-firewall' and proper priority."Refer to Citrix Documentation for details."
```

Configuring the shared VPC

Before adding the Shared VPC as a host connection in Web Studio, complete the following steps to add service accounts from the project you intend to provision into:

1. Create an IAM role.
2. Add the service account used to create a CVAD host connection to the Shared VPC host project IAM role.
3. Add the Cloud Build service account from the project you intend to provision into to the Shared VPC host project IAM role.
4. Create firewall rules.

Create an IAM role Determine the access level of the role —*project level access* or a more restricted model using *subnet level access*.

Project level access for IAM role. For the project level IAM role, include the following permissions:

- `compute.firewalls.list`
- `compute.networks.list`
- `compute.subnetworks.list`
- `compute.subnetworks.use`

To create a project level IAM role:

1. In the Google Cloud console, navigate to **IAM & Admin > Roles**.
2. On the **Roles** page, select **CREATE ROLE**.
3. On the **Create Role** page, specify the role name. Select **ADD PERMISSIONS**.
 - a) On the **Add permissions** page, add permissions to the role, individually. To add a permission, type the name of the permission in the **Filter table** field. Select the permission and then select **ADD**.
 - b) Select **CREATE**.

Subnet-level IAM role. This role omits the addition of the permissions `compute.subnetworks.list` and `compute.subnetworks.use` after selecting **CREATE ROLE**. For this IAM access level, the permissions `compute.firewalls.list` and `compute.networks.list` must be applied to the new role.

To create a subnet level IAM role:

1. In the Google Cloud console, navigate to **VPC network > Shared VPC**. The **Shared VPC** page appears, displaying the subnets of the Shared VPC networks that the host project contains.
2. On the **Shared VPC** page, select the subnet that you want to access.
3. In the top-right corner, select **ADD MEMBER** to add a service account.

4. On the **Add members** page, complete these steps:
 - a) In the **New members** field, type the name of your service account and then select your service account in the menu.
 - b) Select the **Select a role** field and then **Compute Network User**.
 - c) Select **SAVE**.
5. In the Google Cloud console, navigate to **IAM & Admin > Roles**.
6. On the **Roles** page, select **CREATE ROLE**.
7. On the **Create Role** page, specify the role name. Select **ADD PERMISSIONS**.
 - a) On the **Add permissions** page, add permissions to the role, individually. To add a permission, type the name of the permission in the **Filter table** field. Select the permission, and then select **ADD**.
 - b) Select **CREATE**.

Add a service account to the host project IAM role After creating an IAM role, do the following steps to add a service account for the host project:

1. In the Google Cloud console, navigate to the host project and then to **IAM & Admin > IAM**.
2. On the **IAM** page, select **ADD** to add a service account.
3. On the **Add members** page:
 - a) In the **New members** field, type the name of your service account and then select your service account in the menu.
 - b) Select a role field, type the IAM role you created, and then select the role in the menu.
 - c) Select **SAVE**.

The service account is now configured for the host project.

Add the cloud build service account to the shared VPC Every Google Cloud subscription has a service account that is named after the project ID number, followed by `cloudbuild.gserviceaccount`. For example: `705794712345@cloudbuild.gserviceaccount`.

You can determine what the project ID number is for your project by selecting **Home** and **Dashboard** in the Google Cloud console:

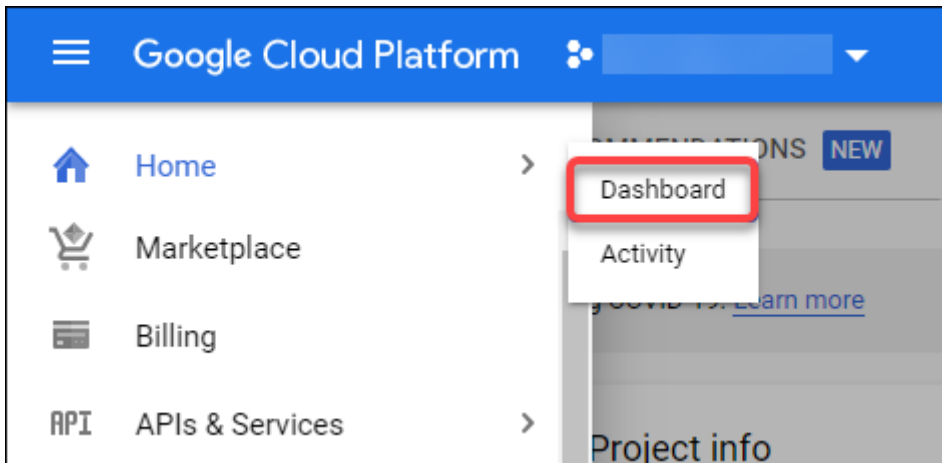

Find the **Project Number** below the **Project Info** area of the screen.

Perform the following steps to add the Cloud Build service account to the Shared VPC:

1. In the Google Cloud console, navigate to the host project and then to **IAM & Admin > IAM**.
2. On the **Permissions** page, select **ADD** to add an account.
3. On the **Add members** page, complete these steps:
 - a) In the **New members** field, type the name of the Cloud Build service account and then select your service account in the menu.
 - b) Select the **Select a role** field, type **Computer Network User**, and then select the role in the menu.
 - c) Select **SAVE**.

Create firewall rules As part of the mastering process, MCS copies the selected machine image and uses it to prepare the master image system disk for the catalog. During mastering, MCS attaches the disk to a temporary virtual machine, which then runs preparation scripts. This VM must run in an isolated environment that prohibits all inbound and outbound network traffic. To create an isolated environment, MCS requires two *deny all* firewall rules (an ingress rule and an egress rule). Therefore, create two firewall rules in the *Host Project* as follows:

1. In the Google Cloud console, navigate to the host project and then to **VPC network > Firewall**.
2. On the **Firewall** page, select **CREATE FIREWALL RULE**.
3. On the **Create a firewall rule** page, complete the following:
 - **Name.** Type a name for the rule.
 - **Network.** Select the Shared VPC network to which the ingress firewall rule applies.
 - **Priority.** The smaller the value is, the higher the priority of the rule is. We recommend a small value (for example, 10).
 - **Direction of traffic.** Select **Ingress**.
 - **Action on match.** Select **Deny**.

- **Targets.** Use the default, **Specified target tags**.
 - **Target tags.** Type `citrix-provisioning-quarantine-firewall`.
 - **Source filter.** Use the default, **IP ranges**.
 - **Source IP ranges.** Type a range that matches all traffic. Type `0.0.0.0/0`.
 - **Protocols and ports.** Select **Deny all**.
4. Select **CREATE** to create the rule.
 5. Repeat steps 1–4 to create another rule. For **Direction of traffic**, select **Egress**.

Add a connection Add a connection to the Google cloud environments. See [Add a connection](#).

Enable zone selection

Citrix Virtual Apps and Desktops supports zone selection. With zone selection, you specify the zones where you want to create VMs. With zone selection, administrators can place sole tenant nodes across zones of their choice. To configure sole tenancy, you must complete the following on Google Cloud:

- Reserve a Google Cloud sole-tenant node
- Create the VDA master image

Reserving a Google Cloud sole-tenant node

To reserve a sole-tenant node, refer to the Google Cloud [documentation](#).

Important:

A node template is used to indicate performance characteristics of the system that is reserved in the node group. Those characteristics include the number of vGPUs, the amount of memory allocated to the node, and the machine type used for machines created on the node. For more information see the Google Cloud [documentation](#).

Creating the VDA master image

To deploy machines on the sole-tenant node successfully, you need to take extra steps when creating a master VM image. Machine instances on Google Cloud have a property called *node affinity labels*. Instances used as master images for catalogs deployed to the sole-tenant node require a *node affinity label* that matches the name of the **target node group**. To achieve this, keep the following in mind:

- For a new instance, set the label in the Google Cloud console when creating an instance. For details, see [Set a node affinity label when creating an instance](#).

- For an existing instance, set the label by using the **gcloud** command line. For details, see Set a node affinity label for an existing instance.

Note:

If you intend to use sole tenancy with a shared VPC, see Shared Virtual Private Cloud.

Set a node affinity label when creating an instance To set the node affinity label:

1. In the Google Cloud console, navigate to **Compute Engine > VM instances**.
2. On the **VM instances** page, select **Create instance**.
3. On the **Instance creation** page, type or configure the required information and then select **management, security, disks, networking, sole tenancy** to open the settings panel.
4. On the **Sole tenancy** tab, select **Browse** to view the available node groups in the current project. The **Sole-tenant node** page appears, displaying a list of available node groups.
5. On the **Sole-tenant node** page, select the applicable node group from the list and then select **Select** to return to the **Sole tenancy** tab. The node affinity labels field populates with the information you selected. This setting ensures that machine catalogs created from the instance will be deployed to the selected node group.
6. Select **Create** to create the instance.

Set a node affinity label for an existing instance To set the node affinity label:

1. In the Google Cloud Shell terminal window, use the `gcloud compute instances` command to set a node affinity label. Include the following information in the **gcloud** command:
 - **Name of the VM.** For example, use an existing VM named `s*2019-vda-base*`.
 - **Name of the node group.** Use the node group name you previously created. For example, `mh-sole-tenant-node-group-1`.
 - **The zone where the instance resides.** For example, the VM resides in the `*us-east-1 b* zone`.

For example, type the following command in the terminal window:

```
gcloud compute instances set-scheduling "s2019-vda-base"--  
node-group="mh-sole-tenant-node-group-1"--zone="us-east1-b"
```

For more information about the `gcloud compute instances` command, see the Google Developer Tools documentation at <https://cloud.google.com/sdk/gcloud/reference/beta/compute/instances/set-scheduling>.

2. Navigate to the **VM instance details** page of the instance and verify that the **Node Affinities** field populates with the label.

Create a machine catalog After setting the node affinity label, configure the machine catalog.

Customer Managed Encryption Keys (CMEK)

You can use Customer Managed Encryption Keys (CMEK) for MCS catalogs. When using this functionality, you assign the Google Cloud Key Management Service [CryptoKey Encrypter/Decrypter](#) role to the Compute Engine Service Agent. Citrix Virtual Apps and Desktops account must have the correct permissions in the project where the key is stored. Refer to [Helping to protect resources by using Cloud KMS keys](#) for more information.

Your Compute Engine Service Agent is in the following form: `service-<Project _Number>@compute-system.iam.gserviceaccount.com`. This form is different than the default Compute Engine Service Account.

Note:

This Compute Engine Service Account might not appear in the Google Console **IAM Permissions** display. In such cases, use the `gcloud` command as described in [Helping to protect resources by using Cloud KMS keys](#).

Assign permissions to Citrix Virtual Apps and Desktops account

Google Cloud KMS permissions can be configured in various ways. You can either provide *project level* KMS permissions or *resource level* KMS permissions. See [Permissions and roles](#) for more information.

Project level permissions One option is to provide Citrix Virtual Apps and Desktops account with project-level permissions to browse Cloud KMS resources. To do this, create a custom role, and add the following permissions:

- `cloudkms.keyRings.list`
- `cloudkms.keyRings.get`
- `cloudkms.cryptokeys.list`
- `cloudkms.cryptokeys.get`

Assign this custom role to your Citrix Virtual Apps and Desktops. This allows you to browse regional keys in the relevant project in the inventory.

Resource Level Permissions For the other option, resource level permissions, in the Google Cloud console, browse to the [cryptoKey](#) you use for MCS provisioning. Add Citrix Virtual Apps and Desktops account to a key ring or a key that you use for catalog provisioning.

Tip:

With this option, you cannot browse regional keys for your project in the inventory because Citrix Virtual Apps and Desktops account does not have project-level list permissions on the Cloud KMS resources. However, you can still provision a catalog using CMEK by specifying the correct `cryptoKeyId` in the `ProvScheme` custom properties, described below.

Provisioning with CMEK using custom properties

When [creating your Provisioning Scheme via PowerShell](#), specify a `CryptoKeyId` property in `ProvScheme CustomProperties`. For example:

```
1 '<CustomProperties xmlns="http://schemas.citrix.com/2014/xd/
   machinecreation" xmlns:xsi="http://www.w3.org/2001/XMLSchema-
   instance">
2   <Property xsi:type="StringProperty" Name="CryptoKeyId" Value="<
   yourCryptoKeyId" />
3 </CustomProperties>'
4 <!--NeedCopy-->
```

The `cryptoKeyId` must be specified in the following format:

`projectId:location:keyRingName:cryptoKeyName`

For example, if you'd like to use the key `my-example-key` in key ring `my-example-key-ring` in the region `us-east1` and project with ID `my-example-project-1`, your `ProvScheme` custom settings would resemble:

```
1 '<CustomProperties xmlns="http://schemas.citrix.com/2014/xd/
   machinecreation" xmlns:xsi="http://www.w3.org/2001/XMLSchema-
   instance">
2   <Property xsi:type="StringProperty" Name="CryptoKeyId" Value="my-
   example-project-1:us-east1:my-example-key-ring:my-example-key"
   />
3 </CustomProperties>'
4 <!--NeedCopy-->
```

All MCS provisioned disks and images related to this provisioning scheme use this customer managed encryption key.

Tip:

If you use global keys, the customer properties location must say `global` and not the **region** name, which in the example above is `us-east1`. For example: `<Property xsi:type="StringProperty"Name="CryptoKeyId"Value="my-example-project-1:global:my-example-key-ring:my-example-key"/>`.

Rotating customer managed keys

Google Cloud does not support rotating keys on existing persistent disks or images. Once a machine is provisioned it is tied to the key version in use at the time it was created. However, a new version of the key can be created and that new key is used for newly provisioned machines or resources created when a catalog is updated with a new master image.

Important considerations about key rings Key rings cannot be renamed or deleted. Also, you might incur unforeseen charges when configuring them. When deleting or removing a key ring, Google Cloud displays an error message:

- ```
1 Sorry, you can't delete or rename keys or key rings. We were concerned
 about the security implications of allowing multiple keys or key
 versions over time to have the same resource name, so we decided to
 make names immutable. (And you can't delete them, because we wouldn't
 be able to do a true deletion--there would still have to be a
 tombstone tracking that this name had been used and couldn't be
 reused).
2 We're aware that this can make things untidy, but we have no immediate
 plans to change this.
3 If you want to avoid getting billed for a key or otherwise make it
 unavailable, you can do so by deleting all the key versions; neither
 keys nor key rings are billed for, just the active key versions
 within the keys.
4 <!--NeedCopy-->
```

### Tip:

For more information, see [Editing or deleting a key ring from the console](#).

## Uniform bucket-level access compatibility

Citrix Virtual Apps and Desktops is compatible with uniform bucket-level access control policy on Google Cloud. This functionality augments the use of IAM policy that grants permissions to a service account to allow for the manipulation of resources, including storage buckets. With uniform bucket level access control, Citrix Virtual Apps and Desktops allows you to use an access control list (ACL) to control access to storage buckets or objects stored in them. See [Uniform bucket-level access](#) for overview information about Google Cloud uniform bucket-level access. For configuration information, see [Require uniform bucket-level access](#).

## Create a machine catalog using PowerShell

This section details how you can create catalogs using PowerShell:



- Create a catalog with persistent write-back cache disk
- Improve boot performance with MCSIO
- Create a machine catalog using a machine profile
- Create a machine catalog with machine profile as an instance template
- Use PowerShell to create a catalog with shielded VM
- Create Windows 11 VMs on the sole-tenant node

## Create a catalog with persistent write-back cache disk

To configure a catalog with persistent write-back cache disk, use the PowerShell parameter `New-ProvScheme CustomProperties`.

### Tip:

Use the PowerShell parameter here only for cloud-based hosting connections. If you want to provision machines using a persistent write-back cache disk for an on-premises solution (for example, XenServer) PowerShell is not needed because the disk persists automatically.

This parameter supports an extra property, `PersistWBC`, used to determine how the write-back cache disk persists for MCS provisioned machines. The `PersistWBC` property is only used when the `UseWriteBackCache` parameter is specified, and when the `WriteBackCacheDiskSize` parameter is set to indicate that a disk is created.

### Note:

This behavior applies to both Azure and GCP where the default MCSIO write-back cache disk is deleted and re-created when power cycling. You can choose to persist the disk to avoid the deletion and recreation of MCSIO write-back cache disk.

Setting the `PersistWBC` property to **true** does not delete the write-back cache disk when the Citrix Virtual Apps and Desktops administrator shuts down the machine from the management interface.

Setting the `PersistWBC` property to **false** deletes the write-back cache disk when the Citrix Virtual Apps and Desktops administrator shuts down the machine from the management interface.

### Note:

If the `PersistWBC` property is omitted, the property defaults to **false** and the write-back cache is deleted when the machine is shut down from the management interface.

For example, using the `CustomProperties` parameter to set `PersistWBC` to **true**:

```
1 <CustomProperties xmlns="http://schemas.citrix.com/2014/xd/machinecreation" xmlns:xsi="http://www.w3.org/2001/XMLSchema-instance">
```

```

2 <Property xsi:type="StringProperty" Name="UseManagedDisks" Value="true"
 />
3 <Property xsi:type="StringProperty" Name="StorageAccountType" Value="
 Premium_LRS" />
4 <Property xsi:type="StringProperty" Name="ResourceGroups" Value="
 benvaldev5RG3" />
5 <Property xsi:type="StringProperty" Name="PersistWBC" Value="true" />
6 </CustomProperties>
7 <!--NeedCopy-->

```

**Note:**

The `PersistWBC` property can only be set using the `New-ProvScheme` PowerShell cmdlet. Attempting to alter the `CustomProperties` of a provisioning scheme after creation has no impact on the machine catalog and the persistence of the write-back cache disk when a machine is shut down.

For example, set `New-ProvScheme` to use the write-back cache while setting the `PersistWBC` property to `true`:

```

1 New-ProvScheme
2 -CleanOnBoot
3 -CustomProperties "<CustomProperties xmlns="http://schemas.citrix.com
 /2014/xd/machinecreation" xmlns:xsi="http://www.w3.org/2001/
 XMLSchema-instance"><Property xsi:type="StringProperty" Name="
 UseManagedDisks" Value="true" /><Property xsi:type="
 StringProperty" Name="StorageAccountType" Value="Premium_LRS"
 /><Property xsi:type="StringProperty" Name="ResourceGroups"
 Value="benvaldev5RG3" /><Property xsi:type="StringProperty" Name
 ="PersistWBC" Value="true" /></CustomProperties>"
4 -HostingUnitName "adSubnetScale1"
5 -IdentityPoolName "BV-WBC1-CAT1"
6 -MasterImageVM "XDHyp:\HostingUnits\adSubnetScale1\image.folder\
 GoldImages.resourcegroup\W10MCSI0-01
 _OsDisk_1_a940e6f5bab349019d57ccef65d2c7e3.manageddisk"
7 -NetworkMapping @{
8 "0"="XDHyp:\HostingUnits\adSubnetScale1\virtualprivatecloud.folder\
 CloudScale02.resourcegroup\adVNET.virtualprivatecloud\
 adSubnetScale1.network" }
9
10 -ProvisioningSchemeName "BV-WBC1-CAT1"
11 -ServiceOffering "XDHyp:\HostingUnits\adSubnetScale1\serviceoffering.
 folder\Standard_D2s_v3.serviceoffering"
12 -UseWriteBackCache
13 -WriteBackCacheDiskSize 127
14 -WriteBackCacheMemorySize 256
15 <!--NeedCopy-->

```

## Improve boot performance with MCSIO

You can improve boot performance for Azure and GCP managed disks when MCSIO is enabled. Use the PowerShell `PersistOsDisk` custom property in the `New-ProvScheme` command to configure this feature. Options associated with `New-ProvScheme` include:

```

1 <CustomProperties xmlns="http://schemas.citrix.com/2014/xd/
 machinecreation" xmlns:xsi="http://www.w3.org/2001/XMLSchema-
 instance">
2 <Property xsi:type="StringProperty" Name="UseManagedDisks" Value="true"
 />
3 <Property xsi:type="StringProperty" Name="StorageAccountType" Value="
 Premium_LRS" />
4 <Property xsi:type="StringProperty" Name="Resource <!--NeedCopy-->
5 <!--NeedCopy-->
6 <!--NeedCopy-->
7 <!--NeedCopy-->Groups" Value="benvaldev5RG3" />
8 <Property xsi:type="StringProperty" Name="PersistOsDisk" Value="true"
 />
9 </CustomProperties>
10 <!--NeedCopy-->

```

To enable this feature, set the `PersistOsDisk` custom property to **true**. For example:

```

1 New-ProvScheme
2 -CleanOnBoot
3 -CustomProperties "<CustomProperties xmlns=`"http://schemas.citrix.com
 /2014/xd/machinecreation`" xmlns:xsi=`"http://www.w3.org/2001/
 XMLSchema-instance`"><Property xsi:type=`"StringProperty`" Name=`"
 UseManagedDisks`" Value=`"true`" /><Property xsi:type=`"
 StringProperty`" Name=`"StorageAccountType`" Value=`"Premium_LRS`"
 /><Property xsi:type=`"StringProperty`" Name=`"ResourceGroups`"
 Value=`"benvaldev5RG3`" /><Property xsi:type=`"StringProperty`" Name
 =`"PersistOsDisk`" Value=`"true`" /></CustomProperties>"
4 -HostingUnitName "adSubnetScale1"
5 -IdentityPoolName "BV-WBC1-CAT1"
6 -MasterImageVM "XDHyp:\HostingUnits\adSubnetScale1\image.folder\
 GoldImages.resourcegroup\W10MCSIO-01
 _OsDisk_1_a940e6f5bab349019d57ccef65d2c7e3.manageddisk"
7 -NetworkMapping @{
8 "0"="XDHyp:\HostingUnits\adSubnetScale1\virtualprivatecloud.folder\
 CloudScale02.resourcegroup\adVNET.virtualprivatecloud\
 adSubnetScale1.network" }
9
10 -ProvisioningSchemeName "BV-WBC1-CAT1"
11 -ServiceOffering "XDHyp:\HostingUnits\adSubnetScale1\serviceoffering.
 folder\Standard_D2s_v3.serviceoffering"
12 -UseWriteBackCache
13 -WriteBackCacheDiskSize 127
14 -WriteBackCacheMemorySize 256
15 <!--NeedCopy-->

```

## Create a machine catalog using a machine profile

When you create a catalog to provision machines using Machine Creation Services (MCS), you can use a machine profile to capture the hardware properties from a virtual machine and apply them to newly provisioned VMs in the catalog. When `MachineProfile` parameter is not used, the hardware properties are captured from the master image VM or snapshot.

Some properties you define explicitly, for example, `StorageType`, `CatalogZones` and `CryptoKeyIs` are ignored from machine profile.

- To create a catalog with a machine profile, use the `New-ProvScheme` command. For example, `New-ProvScheme -MachineProfile "path to VM"`. If you do not specify the `MachineProfile` parameter, hardware properties are captured from the master image VM.
- To update a catalog with a new machine profile, use the `Set-ProvScheme` command. For example, `Set-ProvScheme -MachineProfile "path to new VM"`. This command does not change the machine profile of the existing VMs in the catalog. Only the newly created VMs added to the catalog have the new machine profile.
- You can also update the master image, however, when you update the master image, the hardware properties are not updated. If you want to update the hardware properties, you must update the machine profile using `Set-ProvScheme` command. These changes will only apply to the new machines in the catalog. For updating the hardware properties of an existing machine, you can use the command `Set-ProvVMUpdateTimeWindow` with `-StartsNow` and `-DurationInMinutes -1` parameters.

### Note:

- `StartsNow` indicates that the scheduled start time is the current time.
- `DurationInMinutes` with a negative number (for example, `-1`) indicates no upper bound on the schedule's time window.

## Create a machine catalog with machine profile as an instance template

You can select a GCP instance template as an input for the machine profile. Instance templates are lightweight resources in GCP, therefore, are very cost effective.

### Create a new machine catalog with machine profile as an instance template

1. Open a PowerShell window.
2. Run `asnp citrix*` to load the Citrix-specific PowerShell modules.
3. Find an instance template in your GCP project using the following command:

```
1 cd XDHyp:\HostingUnits\\instanceTemplates.folder
2 <!--NeedCopy-->
```

4. Create a new machine catalog with machine profile as an instance template using New-ProvScheme command:

```
1 New-ProvScheme -ProvisioningSchemeName <CatalogName> -
 HostingUnitName <HostingUnitName> -IdentityPoolName <identity
 pool name> -MasterImageVM
2 XDHyp:\HostingUnits\ \Base.vm\Base.snapshot -
 MachineProfile XDHyp:\HostingUnits\\
 instanceTemplates.folder\mytemplate.template
3 <!--NeedCopy-->
```

For more information on the New-ProvScheme command, see <https://developer-docs.citrix.com/projects/citrix-daas-sdk/en/latest/MachineCreation/New-ProvScheme/>.

5. Finish creating the machine catalog using PowerShell commands. For information on how to create a catalog using the Remote PowerShell SDK, see <https://developer-docs.citrix.com/projects/citrix-virtual-apps-desktops-sdk/en/latest/creating-a-catalog/>.

### Change the machine profile of an existing machine catalog to be an instance template

The detailed steps to change the machine profile of an existing machine catalog to be an instance template are:

1. Open a PowerShell window.
2. Run `asnp citrix*` to load the Citrix-specific PowerShell modules.
3. Run the following command:

```
1 Set-ProvScheme -ProvisioningSchemeName <CatalogName> -
 MachineProfile XDHyp:\HostingUnits\\
 instanceTemplates.folder\

```

For information on the Set-ProvScheme command, see <https://developer-docs.citrix.com/projects/citrix-daas-sdk/en/latest/MachineCreation/Set-ProvScheme/>.

### Use PowerShell to create a catalog with shielded VM

You can create an MCS machine catalog with shielded VM properties. A shielded virtual machine is hardened by a set of security controls that provide verifiable integrity of your Compute Engine instances, using advanced platform security capabilities like secure boot, a virtual trusted platform module, UEFI firmware and integrity monitoring.

MCS supports creating the catalog using the machine profile workflow. If you use machine profile workflow, then you must enable the shielded VM properties of a VM instance. You can then use this VM instance as a machine profile input.

To create an MCS machine catalog with shielded VM using machine profile workflow.

1. Enable shielded VM options of a VM instance in Google Cloud console. See [Quickstart: Enable Shielded VM options](#).
2. Create an MCS machine catalog with machine profile workflow by using the VM instance.
  - a) Open a PowerShell window.
  - b) Run `asnp citrix*` to load the Citrix-specific PowerShell modules.
  - c) Create an identity pool if not already created.
  - d) Run the `New-ProvScheme` command. For example:

```
1 New-ProvScheme -ProvisioningSchemeName <catalog-name>
2 -HostingUnitName gcp-hostint-unit
3 -MasterImageVM XDHyp:\HostingUnits\gcp-hostint-unit\catalog-
 vda.vm
4 -MachineProfile XDHyp:\HostingUnits\gcp-hostint-unit\catalog-
 machine.vm
5 <!--NeedCopy-->
```

3. Finish creating the machine catalog.

To update machine catalog with a new machine profile:

1. Run the `Set-ProvScheme` command. For example:

```
1 Set-ProvScheme -ProvisioningSchemeName <catalog-name>
2 -MasterImageVM XDHyp:\HostingUnits\<hostin-unit>\catalog-vda.vm
3 -MachineProfile "DHyp:\HostingUnits\<hostin-unit>\catalog-machine.
 vm
4 <!--NeedCopy-->
```

To apply the change done in `Set-ProvScheme` to the existing VMs, run the `Set-ProvVMUpdateTimeWindow` command.

1. Run `Set-ProvVMUpdateTimeWindow` command. For example:

```
1 Set-ProvVMUpdateTimeWindow -ProvisioningSchemeName my-catalog -
 VMName <List-Of-Vm-Names> -StartsNow -DurationInMinutes -1
2 <!--NeedCopy-->
```

2. Restart the VMs.

## Create Windows 11 VMs on the sole-tenant node

You can create Windows 11 VMs in GCP. However, if you install Windows 11 on the master image, then you must enable vTPM during the master image creation process. Also, you must enable vTPM on the machine profile source (VM or instance template).

The key steps to create Windows 11 VMs on the sole-tenant node are:

1. Set up the Google Cloud virtualization environments. For information, see [Google Cloud environments](#).
2. Install VDA. See [Install VDAs](#).
3. Create a connection to Google cloud environments. For information, see [Connection to Google cloud environments](#).
4. Create a Windows 11 Bring Your Own License (BYOL) master image and import the image to Google Cloud. See [Create a Windows 11 BYOL master image](#).
5. Create the machine profile source: Provision VM on the sole-tenant node and enable the vTPM of the source machine profile. See [Provision VM on sole-tenant node](#).
6. Create an MCS machine catalog using the Windows 11 machine profile source enabled with vTPM. The machine profile source must have the same instance type as described in the sole-tenant node. See [Create an MCS machine catalog using the Windows 11 machine profile source](#).

## Create a Windows 11 BYOL master image

There are two options to create a Windows 11 BYOL master image and import the master image to Google Cloud:

- Use Google Cloud Cloud Build Tools
- Create the master image on any other hypervisor

## Use Google Cloud Cloud Build Tools

1. Upload the Windows 11 ISO, GCP SDK, .NET framework and PowerShell installer files to the GCP storage bucket.
2. Provide the file location in the cloud build `.yaml` file as parameter.
3. Run the following Cloud Build from the command line to build the final Windows 11 image. GCP bootstraps and creates the master image in the selected project using Daisy workflow in GCP and the master image is imported into GCP.

```
1 gcloud compute instances import INSTANCE-NAME--source-uri=gs://
 BUCKET/IMAGE-OVF-FILE.ovf --guest-os-features=UEFI_COMPATIBLE
 --byol --machine-type=MACHINE-TYPE --zone=ZONE
2 <!--NeedCopy-->
```

**Note:**

Replace all the capital letter text with the actual resource details.

For the complete information, see [Create custom Windows BYOL images](#).

**Create the master image on any other hypervisor**

1. Create the Windows 11 master image using any other hypervisor.
2. Export the master image in an OVF format to the local machine.
3. Upload the OVF files to the GCP storage bucket using the local gcloud CLI.

```
1 gsutil cp LOCAL_IMAGE_PATH_OVF_FILES gs://BUCKET_NAME/
2 <!--NeedCopy-->
```

4. Run the following Cloud Build from the command line to build the final Windows 11 image. GCP bootstraps and creates the master image in the selected project using Daisy workflow in GCP and the master image is imported into GCP.

```
1 gcloud compute instances import INSTANCE-NAME --source-uri=gs://
 BUCKET/IMAGE-OVF-FILE.ovf --guest-os-features=UEFI_COMPATIBLE
 --byol --machine-type=MACHINE-TYPE --zone=ZONE
2 <!--NeedCopy-->
```

**Note:**

Replace all the capital letter text with the actual resource details.

**Provision VM on sole-tenant node**

Use sole-tenant nodes to keep your VMs physically separated from VMs in other projects, or to group your VMs together on the same host hardware. For information on the sole-tenant node, see the GCP document [Sole-tenancy overview](#).

For provisioning a VM (machine profile source) on the sole-tenant node, see the GCP document [Provision VMs on sole-tenant nodes](#).

**Note:**

- Select the same Instance type and region as the node group.
- Enable vTPM in the Shielded VM section. For more information, see [Quickstart: Enable Shielded VM options](#).
- Disable the Bitlocker on the source VM.



## Create an MCS machine catalog using the Windows 11 machine profile source

You can create an MCS machine catalog to create Windows 11 VMs using the Web Studio or PowerShell commands.

**Note:**

- For the master image, select the Windows 11 Snapshot or VM.
- For the machine profile source, select the Windows 11 VM as machine profile. The machine profile source must have the same instance type as described in the sole-tenant node.

For information on using the Web Studio, see [Create a machine catalog using Web Studio](#).

For information on PowerShell commands, see [Create a machine catalog using a machine profile](#)

After you create the catalog and power on the VMs, you can see the Windows 11 VMs running on the sole tenant node on the Google Cloud console.

## Google Cloud Marketplace

You can browse and select images offered by Citrix on **Google Cloud Marketplace** to create machine catalogs. Currently, MCS supports only the machine profile workflow for this feature.

To search for Citrix VDA VM product through Google Cloud Marketplace, go to <https://console.cloud.google.com/marketplace>.

You can use a custom image or a Citrix ready image on **Google Cloud Marketplace** to update an image of a machine catalog.

**Note:**

If the machine profile does not contain storage type information, the value is derived from custom properties.

The supported Google Cloud Marketplace images are:

- Windows 2019 Single Session
- Windows 2019 Multi Session
- Ubuntu

Example of using a Citrix ready image as a source for creating a machine catalog:

```
1 New-ProvScheme -ProvisioningSchemeName GCPCatalog \
2 -HostingUnitName GcpHu -IdentityPoolName gcpPool -CleanOnBoot \
3 -MasterImageVM XDHyp:\HostingUnits\GcpHu\images.folder\citrix-daas-
 win2019-single-vda-v20220819.publicimage \
4 -MachineProfile XDHyp:\HostingUnits\GcpHu\Base.vm
5 <!--NeedCopy-->
```

## Where to go next

- If this is the first catalog created, Web Studio guides you to [create a delivery group](#)
- To review the entire configuration process, see [Install and configure](#)
- To manage catalogs, see [Manage machine catalogs](#) and [Manage a Google Cloud Platform catalog](#)

## More information

- [Create and manage connections and resources](#)
- [Connection to Google cloud environments](#)
- [Create machine catalogs](#)

## Create an HPE Moonshot machine catalog

April 16, 2024

[Create machine catalogs](#) describes the wizards that create a machine catalog. The following information covers details specific to HPE Moonshot environments.

### Note:

- Create a connection to HPE Moonshot
- Make sure to have one or more HPE Moonshot nodes available and install VDAs on those nodes.
- For information about creating the initial HPE Moonshot cartridge image, see the [OS Deployment on Moonshot User Guide](#).

You can create an HPE Moonshot machine catalog using:

- Web Studio
- PowerShell commands

## Create a machine catalog using Web Studio

In the **Machine Catalog Setup** wizard:

1. On the **Operating System** page, select **Multi-session OS** or **Single-session OS**.
2. On the **Machine Management** page, select **Machines that are power managed** and **Another service or technology**.

3. On the **Virtual Machines** page, add machines and their Active Directory machine accounts. You can do either of the following:
  - Click **Add Machines** to add machines manually. The **Select VMs** window appears. Expand the HPE Moonshot chassis connection you created earlier and select the nodes (VMs) you want to add. Then add the associated machine account names.
  - Click **Add CSV File** to bulk add machines. For information about using CSV files to add machines, see [Use CSV files to bulk add machines to a catalog](#).

The **Scopes** and **Summary** pages do not contain HPE Moonshot-specific information.

## Create a machine catalog using PowerShell commands

Run the `New-BrokerCatalog` and `New-BrokerMachine` PowerShell commands to create a broker catalog and import machines to the broker catalog.

For example:

```
1 New-BrokerCatalog -AdminAddress "MyDDC.MyDomain.local" -AdminClientIP
 "103.14.252.249" -AllocationType "Random" -IsRemotePC $False -
 MachinesArePhysical $False -MinimumFunctionalLevel "L7_20" -Name "
 BurMC" -PersistUserChanges "OnLocal" -ProvisioningType "Manual" -
 Scope @() -SessionSupport "MultiSession" -ZoneUid "e166e2cb-25dc
 -4578-bc07-bcf2a82d1463"
2 New-BrokerMachine -AdminAddress "MyDDC.MyDomain.local" -AdminClientIP
 "103.14.252.249" -CatalogUid 3 -HostedMachineId "c10n1" -
 HypervisorConnectionUid 4 -IsReserved $False -MachineName "S
 -1-5-21-2589939477-3963209805-1860259709-1121"
3 <!--NeedCopy-->
```

## Where to go next

- If this is the first catalog created, Web Studio guides you to [create a delivery group](#)
- To review the entire configuration process, see [Install and configure](#)
- To manage catalogs, see [Manage machine catalogs](#) and [Manage an HPE Moonshot catalog](#)

## More information

- [Create and manage connections and resources](#)
- [Connection to HPE Moonshot](#)
- [Create machine catalogs](#)

## Create a Microsoft Azure catalog

March 18, 2024

[Create machine catalogs](#) describes the wizards that create a machine catalog. The following information covers details specific to Microsoft Azure Resource Manager cloud environments.

**Note:**

Before creating a Microsoft Azure catalog, you need to finish creating a connection to Microsoft Azure. See [Connection to Microsoft Azure](#).

### Create a machine catalog

You can create a machine catalog in two ways:

- [Create a machine catalog using an Azure Resource Manager image in Web Studio](#)
- [Create a machine catalog using PowerShell](#)

### Create a machine catalog using an Azure Resource Manager image in Web Studio

An image can be a disk, snapshot, or an image version of an image definition inside the Azure Compute Gallery that is used to create the VMs in a machine catalog. Before creating the machine catalog, create an image in the Azure Resource Manager. For general information about images, see [Create machine catalogs](#).

**Note:**

Support for using a master image from a region different from that configured in the host connection is deprecated. Use Azure Compute Gallery to replicate the master image to the desired region.

During image preparation, a preparation VM is created based on the original VM. This preparation VM is disconnected from the network. To disconnect the network from the preparation VM, a network security group is created to deny all inbound and outbound traffic. The network security group is created automatically once per catalog. The network security group's name is `Citrix-Deny-All-a3pgu-GUID`, where GUID is randomly generated. For example, `Citrix-Deny-All-a3pgu-3f161981-28e2-4223-b797-88b04d336dd1`.

In the machine catalog creation wizard:

- The **Machine Type** and **Machine Management** pages do not contain Azure-specific information. Follow the guidance in the [Create machine catalogs](#) article.

- On the **Image** page, choose an image that you want to use as the template for creating machines in this catalog.

If you select **Master image** as the image type to use, click **Select an image** and follow these steps to select a master image as necessary:

1. (Applicable only to connections configured with shared images within or across tenants)  
Select a subscription where the image resides.
2. Select a resource group.
3. Navigate to the Azure VHD, the Azure Compute Gallery, or the Azure image version. Add a note for the selected image if needed.

When selecting an image, consider the following:

- Verify that a Citrix VDA is installed on the image.
- If you select a VHD attached to a VM, you must shut down the VM before proceeding to the next step.

**Note:**

- The subscription corresponding to the connection (host) that created the machines in the catalog is denoted with a green dot. The other subscriptions are those that have the Azure Compute Gallery shared with that subscription. In those subscriptions, only shared galleries are shown. For information about how to configure shared subscriptions, see [Share images within a tenant \(across subscriptions\)](#) and [Share images across tenants](#).
- Using a machine profile with trusted launch as **Security Type** is mandatory when you select an image or snapshot that has trusted launch enabled. You can then enable or disable SecureBoot and vTPM by specifying their values in the machine profile. Trusted Launch is not supported for Shared Image Gallery. For information about Azure trusted launch, see <https://docs.microsoft.com/en-us/azure/virtual-machines/trusted-launch>.
- You can create a provisioning scheme using ephemeral OS disk on Windows with trusted launch. When you select an image with trusted launch, then you must select a machine profile with trusted launch that is enabled with vTPM. To create machine catalogs using ephemeral OS disk, see [How to create machines using ephemeral OS disks](#).
- When image replication is in progress, you can proceed and select the image as the master image and complete the setup. However, catalog creation might take longer to complete while the image is being replicated. MCS requires the replication to complete within an hour starting from catalog creation. If the replication times out, catalog creation fails. You can verify the replication status in Azure. Try again if the repli-

cation is still pending or after the replication completes.

- When you select a master image for machine catalogs in Azure, MCS identifies the OS type based on the master image and machine profile you select. If MCS can't identify it, select the OS type that matches the master image.
- You can provision a Gen2 VM catalog by using a Gen2 image to improve boot time performance. However, creating a Gen2 machine catalog using a Gen1 image is not supported. Similarly, creating a Gen1 machine catalog using a Gen2 image is also not supported. Also, any older image that does not have generation information is a Gen1 image.

If you select **Prepared image** as the image type to use, click **Select an image** and select a prepared image as necessary.

To ensure successful VM creation, verify that the image has Citrix VDA 2311 or later installed and MCSIO is present on the VDA.

Once you select an image, the **Use a machine profile (mandatory for Azure Active Directory)** check box is automatically selected. Click **Select a machine profile** to browse to a VM or an ARM template spec from a list of resource groups. VMs in the catalog can inherit configurations from the selected machine profile.

Validate the ARM template spec to make sure whether it can be used as a machine profile to create a machine catalog. There are two ways to validate the ARM template spec:

- After you select the ARM template spec from the resource group list, click **Next**. Error messages appear if the ARM template spec has errors.
- Run one of the following PowerShell commands:
  - \* `Test-ProvInventoryItem -HostingUnitName <string> -InventoryPath <string>`
  - \* `Test-ProvInventoryItem -HostingUnitUid <Guid> -InventoryPath <string>`

Examples of configurations that VMs can inherit from a machine profile include:

- Accelerated networking
- Boot diagnostics
- Host disk caching (relating to OS and MCSIO disks)
- Machine size (unless otherwise specified)
- Tags placed on the VM

After you create the catalog, you can view the configurations that the image inherits from the machine profile. On the **Machine Catalogs** node, select the catalog to view its details in the lower pane. Then, click the **Template Properties** tab to view machine profile properties. The **Tags** section displays up to three tags. To view all tags placed on the VM, click **View all**.

If you want MCS to provision VMs on an Azure dedicated host, enable the **Use a dedicated host group** checkbox and then select a host group from the list. A host group is a resource that represents a collection of dedicated hosts. A dedicated host is a service that provides physical servers that host one or more VMs. Your server is dedicated to your Azure subscription, not shared with other subscribers. When you use a dedicated host, Azure ensures that your VMs are the only machines running on that host. This feature is suitable for scenarios where you must meet regulatory or internal security requirements. To learn more about host groups and considerations for using them, see Azure dedicated hosts.

**Important:**

- Only host groups that have Azure auto-placement enabled are shown.
- Using a host group changes the **Virtual Machines** page offered later in the wizard. Only machine sizes that the selected host group contains are shown on that page. Also, Availability Zones are selected automatically and not available for selection.

- The **Storage and License Types** page appears only when you use an Azure Resource Manager image.

The screenshot shows the 'Machine Catalog Setup' wizard with the 'Storage and License Types' page selected. The left sidebar shows a progress list from 1 to 14, with 'Storage and License Types' at step 6. The main content area is titled 'Storage and License Types' and contains the following text and options:

Select the type of storage to use for this machine catalog. MCS configures premium and standard disks to use Locally Redundant Storage (LRS). LRS makes multiple synchronous copies of your disk data within a single data center. The storage type you select affects the machine sizes offered later in this wizard.

- Premium SSD (supports I/O-intensive workloads with significantly high throughput and low latency)
- Standard SSD
- Standard HDD

You can use Windows volume licenses to provision VMs in Azure at the base compute rate. To verify that your volume licensing agreement with Microsoft qualifies for the Azure base compute rate, consult Microsoft.

- Use my Windows Client licenses
- Use my Windows Server licenses
- Use Azure Windows Server licenses

Place image in Azure Shared Image Gallery ?

At the bottom of the wizard, there are three buttons: 'Back', 'Next', and 'Cancel'.

You have the following storage types to use for the machine catalog:

- **Premium SSD.** Offers a high-performance, low-latency disk storage option suitable for VMs with I/O-intensive workloads.

- **Standard SSD.** Offers a cost-effective storage option that is suitable for workloads that require consistent performance at lower IOPS levels.
- **Standard HDD.** Offers a reliable, low-cost disk storage option suitable for VMs that run latency-insensitive workloads.
- **Azure ephemeral OS disk.** Offers a cost-effective storage option that reuses the local disk of the VMs to host the operating system disk. Alternatively, you can use PowerShell to create machines that use ephemeral OS disks. For more information, see Azure ephemeral disks. Be aware of the following considerations when using an ephemeral OS disk:
  - \* Azure ephemeral OS disk and MCS I/O cannot be enabled at the same time.
  - \* To update machines that use ephemeral OS disks, you must select an image whose size does not exceed the size of the VM's cache disk or temporary disk.
  - \* You cannot use the **Retain VM and system disk during power cycles** option offered later in the wizard.

**Note:**

The identity disk is always created using Standard SSD irrespective of the storage type that you choose.

The storage type determines which machine sizes are offered on the **Virtual Machines** page of the wizard. MCS configures premium and standard disks to use Locally Redundant Storage (LRS). LRS makes multiple synchronous copies of your disk data within a single data center. Azure ephemeral OS disks use the local disk of the VMs to store the operating system. For details about Azure storage types and storage replication, see the following:

- <https://docs.microsoft.com/en-us/azure/storage/common/storage-introduction/>
- <https://docs.microsoft.com/en-us/azure/virtual-machines/premium-storage-performance/>
- <https://docs.microsoft.com/en-us/azure/storage/common/storage-redundancy/>

Select whether to use existing Windows licenses or Linux licenses.

- Windows licenses: Using Windows licenses along with Windows images (Azure platform support images or custom images) lets you run Windows VMs in Azure at a reduced cost. There are two types of licenses:
  - \* **Windows Server license.** Lets you use your Windows Server or Azure Windows Server licenses, allowing you to use Azure Hybrid Benefits. For details, see <https://azure.microsoft.com/en-us/pricing/hybrid-benefit/>. Azure Hybrid Benefit reduces the cost of running VMs in Azure to the base compute rate, waiving the cost of extra Windows Server licenses from the Azure gallery.
  - \* **Windows Client license.** Lets you bring your Windows 10 and Windows 11 licenses to



Azure, allowing you to run Windows 10 and Windows 11 VMs in Azure without the need for extra licenses. For details, see [Client Access Licenses and Management Licenses](#).

You can verify that the provisioned VM is using the licensing benefit by running the following PowerShell command: `Get-AzVM -ResourceGroup MyResourceGroup -Name MyVM`.

- For the Windows Server license type, verify that the license type is **Windows\_Server**. More instructions are available at <https://docs.microsoft.com/en-us/azure/virtual-machines/windows/hybrid-use-benefit-licensing/>.
- For the Windows Client license type, verify that the license type is **Windows\_Client**. More instructions are available at <https://docs.microsoft.com/en-us/azure/virtual-machines/windows/windows-desktop-multitenant-hosting-deployment/>.

Alternatively, you can use the `Get-ProvScheme` PowerShell SDK to do the verification. For example: `Get-ProvScheme -ProvisioningSchemeName "My Azure Catalog"`. For more information about this cmdlet, see <https://developer-docs.citrix.com/projects/citrix-virtual-apps-desktops-sdk/en/latest/MachineCreation/Get-ProvScheme/>.

- Linux licenses: With bring-your-own-subscription (BYOS) Linux licenses, you do not have to pay for the software. The BYOS charge only includes the compute hardware fee. There are two types of licenses:
  - \* **RHEL\_BYOS**: To use RHEL\_BYOS type successfully, enable Red Hat Cloud Access on your Azure subscription.
  - \* **SLES\_BYOS**: The BYOS versions of SLES include support from SUSE.

You can set the `LicenseType` value to Linux options at `New-ProvScheme` and `Set-ProvScheme`.

Example of setting `LicenseType` to `RHEL_BYOS` at `New-ProvScheme`:

```
1 New-ProvScheme -CleanOnBoot -ProvisioningSchemeName "
 azureCatalog" -RunAsynchronously -Scope @() -SecurityGroup
 @() -CustomProperties '<CustomProperties xmlns="http://
 schemas.citrix.com/2014/xd/machinecreation" xmlns:xsi="http
 ://www.w3.org/2001/XMLSchema-instance"><Property xsi:type="
 StringProperty" Name="UseManagedDisks" Value="true" /><
 Property xsi:type="StringProperty" Name="StorageAccountType
 " Value="StandardSSD_LRS" /><Property xsi:type="
 StringProperty" Name="ResourceGroups" Value="hu-dev-mcs"
 /><Property xsi:type="StringProperty" Name="OsType" Value="
 Linux" /><Property xsi:type="StringProperty" Name="
 LicenseType" Value="RHEL_BYOS" /></CustomProperties>'
2 <!--NeedCopy-->
```

Example of setting `LicenseType` to `SLES_BYOS` at `Set-ProvScheme`:

```

1 Set-ProvScheme -ProvisioningSchemeName "azureCatalog" -
 CustomProperties '<CustomProperties xmlns="http://schemas.
 citrix.com/2014/xd/machinecreation" xmlns:xsi="http://www.
 w3.org/2001/XMLSchema-instance"><Property xsi:type="
 StringProperty" Name="UseManagedDisks" Value="true" /><
 Property xsi:type="StringProperty" Name="StorageAccountType
 " Value="StandardSSD_LRS" /><Property xsi:type="
 StringProperty" Name="ResourceGroups" Value="hu-dev-mcs"
 /><Property xsi:type="StringProperty" Name="OsType" Value="
 Linux" /><Property xsi:type="StringProperty" Name="
 LicenseType" Value="SLES_BYOS" /></CustomProperties>'
2 <!--NeedCopy-->

```

**Note:**

If `LicenseType` value is empty, then the default values are Azure Windows Server License or Azure Linux License, depending on `OsType` value.

Example of setting `LicenseType` to empty:

```

1 Set-ProvScheme -ProvisioningSchemeName "azureCatalog" -
 CustomProperties '<CustomProperties xmlns="http://schemas.
 citrix.com/2014/xd/machinecreation" xmlns:xsi="http://www.
 w3.org/2001/XMLSchema-instance"><Property xsi:type="
 StringProperty" Name="UseManagedDisks" Value="true" /><
 Property xsi:type="StringProperty" Name="StorageAccountType
 " Value="StandardSSD_LRS" /><Property xsi:type="
 StringProperty" Name="ResourceGroups" Value="hu-dev-mcs"
 /><Property xsi:type="StringProperty" Name="OsType" Value="
 Linux" /></CustomProperties>'
2 <!--NeedCopy-->

```

See the following documents to understand License types and their benefits:

- <https://docs.microsoft.com/en-us/dotnet/api/microsoft.azure.management.compute.models.virtualmachine.licensetype?view=azure-dotnet>
- <https://docs.microsoft.com/en-us/azure/virtual-machines/linux/azure-hybrid-benefit-linux>

Azure Compute Gallery (formerly Azure Shared Image Gallery) is a repository for managing and sharing images. It lets you make your images available throughout your organization. We recommend that you store an image in SIG when creating large non-persistent machine catalogs because doing that enables faster resets of VDA OS disks. After you select **Place prepared image in Azure Compute Gallery**, the **Azure Compute Gallery settings** section appears, letting you specify more Azure Compute Gallery settings:

- **Ratio of virtual machines to image replicas.** Lets you specify the ratio of virtual machines to image replicas that you want Azure to keep. By default, Azure keeps a single im-

age replica for every 40 non-persistent machines. For persistent machines, that number defaults to 1,000.

- **Maximum replica count.** Lets you specify the maximum number of image replicas that you want Azure to keep. The default is 10.
- On the **Virtual Machines** page, indicate how many VMs you want to create. You must specify at least one and select a machine size. After catalog creation, you can change the machine size by editing the catalog.
- The **NICs** page does not contain Azure-specific information. Follow the guidance in the [Create machine catalogs](#) article.
- On the **Disk Settings** page, choose whether to enable write-back cache. With the MCS storage optimization feature enabled, you can configure the following settings when creating a catalog. These settings apply to both Azure and GCP environments.

The screenshot shows the 'Machine Catalog Setup' dialog box with the 'Disk Settings' section active. The left sidebar shows a progress list with 'Disk Settings' highlighted. The main area contains the following settings:

- Write-back cache disk:**
  - Enable write-back cache
  - Memory allocated to cache (MB): 256
  - Disk cache size (GB): 127
- Select the storage type for the write-back cache disk:**
  - Premium SSD
  - Standard SSD
  - Standard HDD
- Select the type for the write-back cache disk:**
  - Use non-persistent write-back cache disk
  - Use persistent write-back cache disk
- System disk:**
  - Retain system disk during power cycles
  - Retain VMs across power cycles
- Customer-managed encryption key:**
  - Use the following key to encrypt data on each machine
  - Select a Disk Encryption Set (dropdown menu)

At the bottom, there are 'Back', 'Next', and 'Cancel' buttons.

After enabling write-back cache, you can do the following:

- Configure the size of the disk and RAM used for caching temporary data. For more information, see [Configure cache for temporary data](#).
- Select the storage type for the write-back cache disk. The following storage options are available to use for the write-back cache disk:
  - \* Premium SSD
  - \* Standard SSD

- ★ Standard HDD

- Choose whether you want the write-back cache disk to persist for the provisioned VMs. Select **Enable write-back cache** to make the options available. By default, **Use non-persistent write-back cache disk** is selected.
- Select the type for the write-back cache disk.

- ★ **Use non-persistent write-back cache disk.** If selected, the write-back cache disk is deleted during power cycles. Any data redirected to it will be lost. If the VM's temporary disk has sufficient space, it is used to host the write-back cache disk to reduce your costs. After catalog creation, you can check whether the provisioned machines use the temporary disk. To do so, click the catalog and verify the information on the **Template Properties** tab. If the temporary disk is used, you see **Non-persistent Write-back Cache Disk** and its value is **Yes (using VM's temporary disk)**. If not, you see **Non-persistent Write-back Cache Disk** and its value is **No (not using VM's temporary disk)**.

- ★ **Use persistent write-back cache disk.** If selected, the write-back cache disk persists for the provisioned VMs. Enabling the option increases your storage costs.

- Choose whether to retain VMs and system disks for VDAs during power cycles.

**Retain VM and system disk during power cycles.** Available when you've selected **Enable write-back cache**. By default, VMs and the system disks are deleted on shutdown and recreated on startup. If you want to reduce VM restart times, select this option. Keep in mind that enabling this option also increases storage costs.

- Choose whether to enable **Storage cost savings**. If enabled, save storage costs by downgrading the storage disk to Standard HDD when the VM shuts down. The VM switches to its original settings on restart. The option applies to both storage and write-back cache disks. Alternatively, you can also use PowerShell. See [Change the storage type to a lower tier when a VM is shut down](#).

**Note:**

Microsoft imposes restrictions on changing the storage type during VM shutdown. It's also possible that Microsoft will block storage type changes in the future. For more information, see this [Microsoft article](#).

- Choose whether to encrypt data on the machines provisioned in the catalog. Server-side encryption with a customer-managed encryption key lets you manage encryption at a managed disk level and protect data on the machines in the catalog. For more information, see [Azure server-side encryption](#).

- On the **Resource Group** page, choose whether to create resource groups or use existing groups.

- If you choose to create resource groups, select **Next**.
- If you choose to use existing resource groups, select groups from the **Available Provisioning Resource Groups** list. **Remember:** Select enough groups to accommodate the machines you're creating in the catalog. A message appears if you choose too few. You might want to select more than the minimum required if you plan to add more VMs to the catalog later. You can't add more resource groups to a catalog after the catalog is created.

For more information, see Azure resource groups.

- On the **Machine Identities** page, choose an identity type and configure identities for machines in this catalog. If you select the VMs as **Azure Active Directory joined**, you can add them to an Azure AD security group. Detailed steps are as follows:
  1. From the **Identity type** field, select **Azure Active Directory joined**. The **Azure AD security group (optional)** option appears.
  2. Click **Azure AD security group: Create new**.
  3. Enter a group name, and then click **Create**.
  4. Follow the onscreen instructions to sign in to Azure.  
If the group name doesn't exist in Azure, a green icon appears. Otherwise, an error message appears requesting you to enter a new name.
  5. Enter the machine account naming scheme for the VMs.

After catalog creation, Citrix Virtual Apps and Desktops accesses Azure on your behalf and creates the security group and a dynamic membership rule for the group. Based on the rule, VMs with the naming scheme specified in this catalog are automatically added to the security group.

Adding VMs with a different naming scheme to this catalog requires you to sign in to Azure. Citrix Virtual Apps and Desktops can then access Azure and create a dynamic membership rule based on the new naming scheme.

When deleting this catalog, deleting the security group from Azure also requires signing in to Azure.

- The **Domain Credentials** and **Summary** pages do not contain Azure-specific information. Follow the guidance in the [Create machine catalogs](#) article.

Complete the wizard.

### Conditions for Azure temporary disk to be eligible for write-back cache disk

You can use the Azure temporary disk as write-back cache disk only if all the following conditions are satisfied:

- The write-back cache disk must non-persist as the Azure temporary disk is not appropriate for persistent data.

- The chosen Azure VM size must include a temporary disk.
- The ephemeral OS disk is not required to be enabled.
- Accept to place the write-back cache file on Azure temporary disk.
- The Azure temporary disk size must be greater than the total size of (write-back cache disk size + reserved space for paging file + 1 GB buffer space).

### Non-persistent write-back cache disk scenarios

The following table describes three different scenarios when temporary disk is used for write-back cache while creating machine catalog.

| Scenario                                                                                                                   | Outcome                                                                                                    |
|----------------------------------------------------------------------------------------------------------------------------|------------------------------------------------------------------------------------------------------------|
| All conditions to use temporary disk for write-back cache are satisfied.                                                   | The WBC file <code>mcsdif.vhdx</code> is placed on the temporary disk.                                     |
| Temporary disk has insufficient space for write-back cache usage.                                                          | A VHD disk <code>MCSWCDisk</code> is created and WBC file <code>mcsdif.vhdx</code> is placed on this disk. |
| Temporary disk has sufficient space for write-back cache usage but <code>UseTempDiskForWBC</code> is set to <b>false</b> . | A VHD disk <code>MCSWCDisk</code> is created and WBC file <code>mcsdif.vhdx</code> is placed on this disk. |

### Create an Azure template spec

You can create an Azure template spec in the Azure portal and use it in Web Studio and PowerShell commands to create or update an MCS machine catalog.

To create an Azure template spec for an existing VM:

1. Go to the Azure portal. Select a resource group, and then select the VM and network interface. From the ... menu on the top, click **Export template**.
2. Clear **Include parameters** checkbox if you want to create a template spec for catalog provisioning.
3. Click **Add to library** to modify the template spec later.
4. On the **Importing template** page, enter the required information such as **Name**, **Subscription**, **Resource Group**, **Location**, and **Version**. Click **Next: Edit Template**.
5. You also need a network interface as an independent resource if you want to provision catalogs. Therefore, you must remove any `dependsOn` specified in the template spec. For example:

```

1 "dependsOn": [
2 "[resourceId('Microsoft.Network/networkInterfaces', 'tnic937')]"
3],
4 <!--NeedCopy-->

```

6. Create **Review+Create** and create the template spec.
7. On the **Template Specs** page, verify the template spec you just created. Click the template spec. On the left panel, click **Versions**.
8. You can create a new version by clicking **Create new version**. Specify a new version number, make changes to the current template spec, and click **Review + Create** to create the new version of the template spec.

You can get information about the template spec and template version using the following PowerShell commands:

- To get information about the template spec, run:

```

1 get-item XDHyp:\HostingUnits\East\machineprofile.folder\abc.
 resourcegroup\bggTemplateSpec.templatespec
2 <!--NeedCopy-->

```

- To get information about the template spec version, run:

```

1 get-item XDHyp:\HostingUnits\East\machineprofile.folder\abc.
 resourcegroup\bggTemplateSpec.templatespec\bgg1.0.
 templatespecversion
2 <!--NeedCopy-->

```

## Use template spec in creating or updating a catalog

You can create or update an MCS machine catalog using a template spec as a machine profile input. To do this, you can use the Web Studio or PowerShell commands.

- For Web Studio, see [Create a machine catalog using an Azure Resource Manager image in Web Studio](#)
- For PowerShell, see [Use template spec in creating or updating a catalog using PowerShell](#)

## Azure server-side encryption

Citrix Virtual Apps and Desktops supports customer-managed encryption keys for Azure managed disks through Azure Key Vault. With this support you can manage your organizational and compliance requirements by encrypting the managed disks of your machine catalog using your own encryption key. For more information, see [Server-side encryption of Azure Disk Storage](#).

When using this feature for managed disks:

- To change the key that the disk is encrypted with, you change the current key in the [DiskEncryptionSet](#). All resources associated with that [DiskEncryptionSet](#) change to be encrypted with the new key.
- When you disable or delete your key, any VMs with disks using that key automatically shut down. After shutting down, the VMs are not usable unless the key is enabled again or you assign a new key. Any catalog using the key cannot be powered on, and you cannot add VMs to it.

### **Important considerations when using customer-managed encryption keys**

Consider the following when using this feature:

- All resources related to your customer-managed keys (Azure Key Vaults, disk encryption sets, VMs, disks, and snapshots) must reside in the same subscription and region.
- Once you have enabled the customer-managed encryption key that you cannot disable it later. If you want to disable or remove the customer-managed encryption key, copy all the data to a different managed disk that is not using the customer-managed encryption key.
- Disks created from encrypted custom images using server-side encryption and customer-managed keys must be encrypted using the same customer-managed keys. These disks must be in the same subscription.
- Snapshots created from disks that are encrypted with server-side encryption and customer-managed keys must be encrypted with the same customer-managed keys.
- Disks, snapshots, and images encrypted with customer-managed keys cannot move to another resource group and subscription.
- Managed disks currently or previously encrypted using Azure Disk Encryption cannot be encrypted using customer-managed keys.
- Refer to the [Microsoft site](#) for limitations on disk encryption sets per region.

#### **Note:**

See [Quickstart: Create a Key Vault using the Azure portal](#) for information on configuring Azure server-side encryption.

### **Azure Customer-managed encryption key**

When creating a machine catalog, you can choose whether to encrypt data on the machines provisioned in the catalog. Server-side encryption with a customer-managed encryption key lets you man-



age encryption at a managed disk level and protect data on the machines in the catalog. A Disk Encryption Set (DES) represents a customer-managed key. To use this feature, you must first create your DES in Azure. A DES is in the following format:

- `/subscriptions/12345678-1234-1234-1234-123456789012/resourceGroups/Sample-RG/providers/Microsoft.Compute/diskEncryptionSets/SampleEncryption`

Select a DES from the list. The DES you select must be in the same subscription and region as your resources. If your image is encrypted with a DES, use the same DES when creating the machine catalog. You cannot change the DES after you create the catalog.

If you create a catalog with an encryption key and later disable the corresponding DES in Azure, you can no longer power on the machines in the catalog or add machines to it.

See [Creating a machine catalog using customer-managed key](#).

## Azure disk encryption at host

You can create an MCS machine catalog with encryption at host capability. Currently, MCS supports only the machine profile workflow for this feature. You can use a VM or a template spec as an input for a machine profile.

This encryption method does not encrypt the data through the Azure storage. The server hosting the VM encrypts the data and then the encrypted data flows through the Azure storage server. Hence, this method of encryption encrypts data end to end.

### Restrictions:

Azure disk encryption at host is:

- Not supported for all Azure machine sizes
- Incompatible with Azure disk encryption

To create a machine catalog with encryption at host capability:

1. Check if the subscription has the encryption at host feature enabled or not. To do this, see <https://learn.microsoft.com/en-us/rest/api/resources/features/get?tabs=HTTP/>. If not enabled, you must enable the feature for the subscription. For information on enabling the feature for your subscription, see <https://learn.microsoft.com/en-us/azure/virtual-machines/disks-enable-host-based-encryption-portal?tabs=azure-powershell#prerequisites/>.
2. Check if a particular Azure VM size supports encryption at host or not. To do this, in a PowerShell window, run one of the following:

```
1 PS XDHyp:\Connections\\east us.region\
 serviceoffering.folder>
2 <!--NeedCopy-->
```

```
1 PS XDHyp:\HostingUnits\\serviceoffering.folder>
2 <!--NeedCopy-->
```

3. Create a VM or a template spec, as an input for machine profile, in Azure portal with encryption at host enabled.
  - If you want to create a VM, select a VM size that supports encryption at host. After you create the VM, the VM property **Encryption at host** is enabled.
  - If you want to use a template spec, assign the parameter `Encryption at Host` as **true** inside `securityProfile`.
4. Create an MCS machine catalog with machine profile workflow by either selecting a VM or a template spec.
  - OS disk / Data Disk: Gets encrypted through Customer-managed key and Platform-managed key
  - Ephemeral OS Disk: Gets encrypted only through Platform-managed key
  - Cache Disk: Gets encrypted through Customer-managed key and Platform-managed key

You can create the machine catalog using Web Studio or running PowerShell commands.

### Retrieve encryption at host information from a machine profile

You can retrieve the encryption at host information from a machine profile when you run the PowerShell command with the `AdditionalData` parameter. If `EncryptionAtHost` parameter is **True**, it indicates that the encryption at host is enabled for the machine profile.

For example: When the machine profile input is a VM, run the following command:

```
1 (get-item XDHyp:\HostingUnits\myAzureNetwork\machineprofile.folder\abc.
 resourcegroup\def.vm).AdditionalData
2 <!--NeedCopy-->
```

For example: When the machine profile input is a template spec, run the following command:

```
1 (get-item XDHyp:\HostingUnits\myAzureNetwork\machineprofile.folder\abc.
 resourcegroup\def_templatespec.templatespec\EncryptionAtHost.
 templatespecversion).AdditionalData
2 <!--NeedCopy-->
```

## Double encryption on managed disk

You can create a machine catalog with double encryption. Any catalogs created with this feature have all disks server side encrypted with both platform and customer-managed keys. You own and maintain the Azure Key Vault, Encryption Key, and the Disk Encryption Sets (DES).

Double encryption is platform-side encryption (default) and customer-managed encryption (CMEK). Therefore, if you are a high security sensitive customer who is concerned about the risk associated with any encryption algorithm, implementation, or a compromised key, you can opt for this double encryption. Persistent OS and data disks, snapshots, and images are all encrypted at rest with double encryption.

### Note:

- You can create and update a machine catalog with double encryption using Web Studio and PowerShell commands. See [Create a machine catalog with double encryption for PowerShell commands](#).
- You can use non-machine profile-based workflow or machine profile-based workflow for creating or updating a machine catalog with double encryption.
- If you use non-machine profile-based workflow to create a machine catalog, you can reuse the stored `DiskEncryptionSetId`.
- If you use a machine profile, you can use a VM or template spec as a machine profile input.

### Limitations:

- Double encryption is not supported for Ultra Disks or Premium SSD v2 disks.
- Double encryption is not supported on unmanaged disks.
- If you disable a `DiskEncryptionSet` key associated with a catalog, then the VMs of the catalog are disabled.
- All resources related to your customer-managed keys (Azure Key Vaults, disk encryption sets, VMs, disks, and snapshots) must be in the same subscription and region.
- You can only create up to 50 disk encryption sets per region per subscription.
- You cannot update a machine catalog that already has a `DiskEncryptionSetId` with a different `DiskEncryptionSetId`.

## Azure resource groups

Azure provisioning resource groups provide a way to provision the VMs that provide applications and desktops to users. You can add existing empty Azure resource groups when you create an MCS machine catalog, or have new resource groups created for you. For information about Azure resource groups, see the [Microsoft documentation](#).

## Azure Resource Group Usage

There is no limit on the number of virtual machines, managed disks, snapshots, and images per Azure Resource Group. (The limit of 240 VMs per 800 managed disks per Azure Resource Group has been removed.)

- When using a full-scope service principal to create a machine catalog, MCS creates only one Azure Resource Group and uses that group for the catalog.
- When using a narrow scope service principal to create a machine catalog, you must supply an empty, pre-created Azure Resource Group for the catalog.

## Azure ephemeral disks

An [Azure ephemeral disk](#) allows you to repurpose the cache disk or temporary disk to store the OS disk for an Azure-enabled virtual machine. This functionality is useful for Azure environments that require a higher performant SSD disk over a standard HDD disk. For information on creating a catalog with an Azure ephemeral disk, see [Create a catalog with an Azure ephemeral disks](#).

### Note:

Persistent catalogs do not support ephemeral OS disks.

Ephemeral OS disks require that your provisioning scheme uses managed disks and a Shared Image Gallery.

## Storing an ephemeral OS temporary disk

You have the option of storing an ephemeral OS disk on the VM temp disk or a resource disk. This functionality enables you to use an ephemeral OS disk with a VM that either doesn't have a cache, or has insufficient cache. Such VMs have a temp or resource disk to store an ephemeral OS disk, such as [DdV4](#).

Consider the following:

- An ephemeral disk is stored either in the VM cache disk, or the VM's temporary (resource) disk. The cache disk is preferred over the temporary disk, unless the cache disk is not large enough to hold the contents of the OS disk.
- For updates, a new image that is larger than the cache disk but smaller than the temp disk results in replacing the ephemeral OS disk with the VM's temp disk.

## Azure ephemeral disk and Machine Creation Services (MCS) storage optimization (MCS I/O)

Azure ephemeral OS disk and MCS I/O cannot be enabled at the same time.

The important considerations are as follows:

- You cannot create a machine catalog with both ephemeral OS disk and MCS I/O enabled at the same time.
- The PowerShell parameters (`UseWriteBackCache` and `UseEphemeralOsDisk`) fail with proper error messages if you set them to **true** in `New-ProvScheme` or `Set-ProvScheme`.
- For existing machine catalogs created with both features enabled, you can still:
  - update a machine catalog.
  - add or delete VMs.
  - delete a machine catalog.

## Azure Compute Gallery

Use Azure Compute Gallery (formerly Azure Shared Image Gallery) as a published image repository for MCS provisioned machines in Azure. You can store a published image in the gallery to accelerate the creation and hydration of OS disks, improving start and application launch times for non-persistent VMs. The shared image gallery contains the following three elements:

- *Gallery*: Images are stored here. MCS creates one gallery for each machine catalog.
- *Gallery Image Definition*: This definition includes information (operating system type and state, Azure region) about the published image. MCS creates one image definition for each image created for the catalog.
- *Gallery Image Version*: Each image in a Shared Image Gallery can have multiple versions, and each version can have multiple replicas in different regions. Each replica is a full copy of the published image.

### Note:

Shared Image Gallery functionality is only compatible with managed disks. It is not available for legacy machine catalogs.

For more information, see [Azure Compute Gallery overview](#).

For information on creating or updating a machine catalog using Azure Compute Gallery image using PowerShell, see [Create or update a machine catalog using an Azure Compute Gallery image](#).

## Azure Marketplace

Citrix Virtual Apps and Desktops supports using a master image on Azure that contains plan information to create a machine catalog. For more information, see [Microsoft Azure Marketplace](#).

### Tip:

Some images found on the Azure Marketplace, like the standard Windows Server image, do not append plan information. Citrix Virtual Apps and Desktops feature is for paid images.

## Ensure that the image created in Shared Image Gallery contains Azure plan information

Use the procedure in this section to view Shared Image Gallery images in Web Studio. These images can optionally be used for a master image. To put the image into a Shared Image Gallery, create an image definition in a gallery.

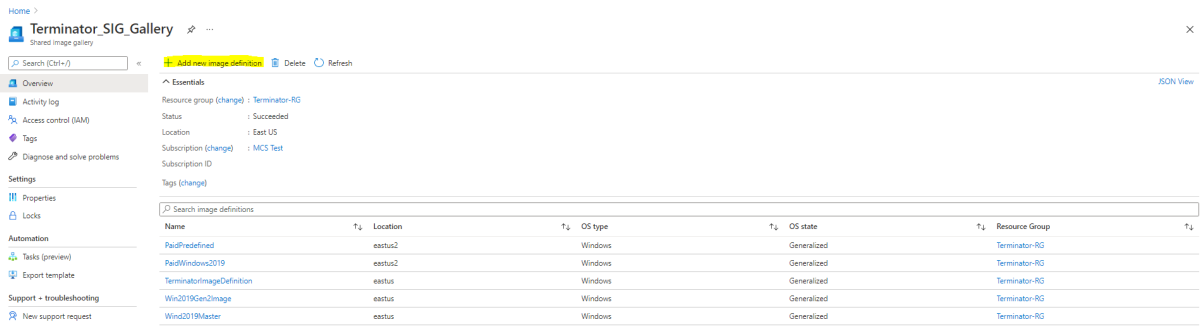

In the **Publishing options** page, verify the purchase plan information.

The purchase plan information fields are initially empty. Populate those fields with the purchase plan information used for the image. Failure to populate purchase plan information can cause the machine catalog process to fail.

Microsoft Azure

Home > PaidPredefined (Terminator\_SIG\_Gallery/PaidPredefined) > Terminator\_SIG\_Gallery > Add new image definition to shared image gallery

Basics Version Publishing options Tags Review + create

Provide additional metadata about the image, including recommended VM specifications, and links to release notes and privacy policies.

**Publishing meta data**

EULA link

Description

Release notes URI

Privacy URI

Purchase plan name

Purchase plan publisher name

Purchase plan product name

**VM deployment**

Provide recommendations for VM specifications for this image. These recommendations are informational only, and do not constrain VM specification.

Recommended VM vCPUs  16

Recommended VM memory  32

Excluded disk types

Image definition end of life date

Review + create < Previous Next: Tags >

After verifying the purchase plan information, create an image version within the definition. This is used as the master image. Click **Add version**:

Home > Terminator\_SIG\_Gallery > PaidPredefined (Terminator\_SIG\_Gallery/PaidPredefined)

Image definition

Search (Ctrl+F)

Essentials

Resource group (change) : Terminator-RG

Location (change) : East US 2

Subscription (change) : MCS Test

Subscription ID :

Status : Succeeded

Tags (change) :

Shared image gallery : Terminator\_SIG\_Gallery

Operating system : Windows

Operating system state : Generalized

Publisher : Offer : SKU : PaidPublisher2 : PaidOffer2 : PaidSKU2

JSON View

Properties Get started Image versions

Filter by number... Showing 1 of 1 image versions

Add version Delete

| Number | Provisioning State | Published date       | Target regions | Replication status | Create VM from version    |
|--------|--------------------|----------------------|----------------|--------------------|---------------------------|
| 1.0.0  | Succeeded          | 7/7/2021, 2:13:24 PM | East US        | Completed          | <a href="#">Create VM</a> |

In the **Version details** section, select the image snapshot or managed disk as the source:

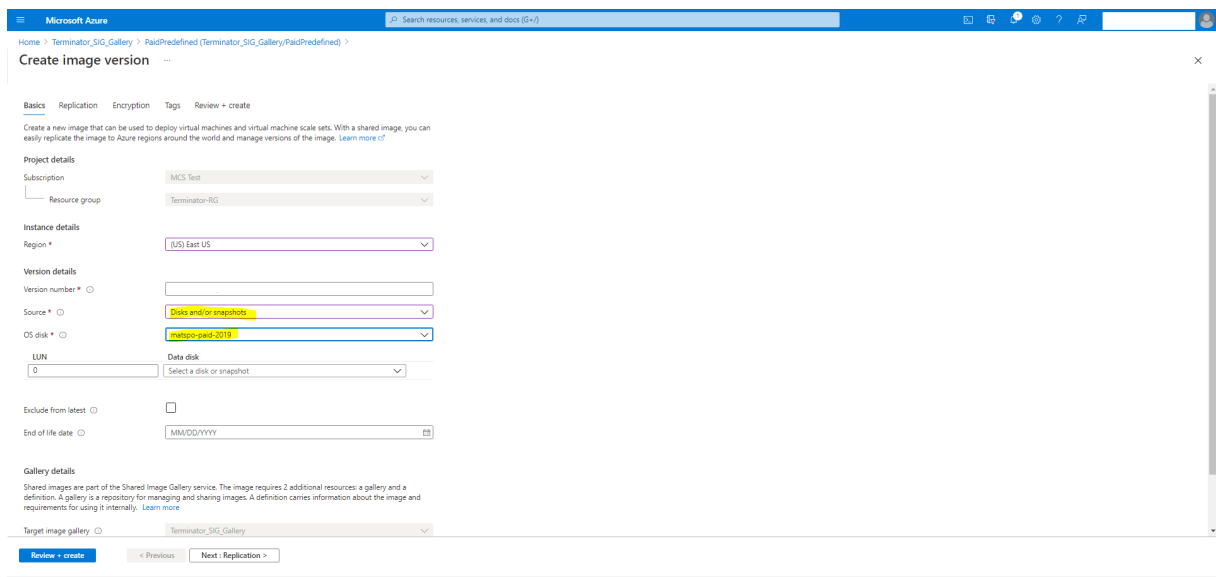

## Create a machine catalog using PowerShell

This section details how you can create catalogs using PowerShell:

- Create a catalog with non-persistent write-back cache disk
- Create a catalog with persistent write-back cache disk
- Improve boot performance with MCSIO
- Use template spec in creating or updating a catalog using PowerShell
- Machine catalogs with Trusted launch
- Use machine profile property values
- Create a machine catalog with customer-managed encryption key
- Create a machine catalog with double encryption
- Create a catalog with an Azure ephemeral disks
- Azure dedicated hosts
- Create or update a machine catalog using an Azure Compute Gallery image
- Configure Shared Image Gallery
- Provision machines into specified Availability Zones
- Storage types
- Page file location
- Update page file setting
- Create a catalog using Azure Spot VMs
- Configure backup VM sizes
- Copy tags on all resources
- Provision catalog VMs with Azure Monitor Agent installed



## Create a catalog with non-persistent write-back cache disk

To configure a catalog with non-persistent write-back cache disk, use the PowerShell parameter `New-ProvScheme CustomProperties`. The custom property `UseTempDiskForWBC` indicates whether you are accepting to use the Azure temporary storage to store the write-back cache file. This must be configured to `true` when running `New-ProvScheme` if you want to use the temporary disk as write-back cache disk. If this property is not specified, the parameter is set to **False** by default.

For example, using the `CustomProperties` parameter to set `UseTempDiskForWBC` to **true**:

```

1 -CustomProperties '<CustomProperties xmlns=" http://schemas.citrix.com
 /2014/xd/machinecreation" xmlns:xsi=" http://www.w3.org/2001/
 XMLSchema-instance"> `
2 <Property xsi:type="StringProperty" Name="PersistWBC" Value="false"/> `
3 <Property xsi:type="StringProperty" Name="PersistOsDisk" Value="false
 "/> `
4 <Property xsi:type="StringProperty" Name="PersistVm" Value="false"/> `
5 <Property xsi:type="StringProperty" Name="StorageAccountType" Value="
 Premium_LRS"/> `
6 <Property xsi:type="StringProperty" Name="WBCDiskStorageType" Value="
 Premium_LRS"/> `
7 <Property xsi:type="StringProperty" Name="LicenseType" Value="
 Windows_Client"/> `
8 <Property xsi:type="StringProperty" Name="UseTempDiskForWBC" Value="
 true"/> `
9 </CustomProperties>'
10 <!--NeedCopy-->

```

### Note:

After you commit the machine catalog to use Azure local temporary storage for write-back cache file, it cannot be changed to use VHD later.

## Create a catalog with persistent write-back cache disk

To configure a catalog with persistent write-back cache disk, use the PowerShell parameter `New-ProvScheme CustomProperties`. This parameter supports an extra property, `PersistWBC`, used to determine how the write-back cache disk persists for MCS provisioned machines. The `PersistWBC` property is only used when the `UseWriteBackCache` parameter is specified, and when the `WriteBackCacheDiskSize` parameter is set to indicate that a disk is created.

Examples of properties found in the `CustomProperties` parameter before supporting `PersistWBC` include:

```

1 <CustomProperties xmlns="http://schemas.citrix.com/2014/xd/
 machinecreation" xmlns:xsi="http://www.w3.org/2001/XMLSchema-
 instance">

```

```

2 <Property xsi:type="StringProperty" Name="UseManagedDisks" Value="true"
 />
3 <Property xsi:type="StringProperty" Name="StorageAccountType" Value="
 Premium_LRS" />
4 <Property xsi:type="StringProperty" Name="ResourceGroups" Value="
 benva1dev5RG3" />
5 </CustomProperties>
6 <!--NeedCopy-->

```

When using these properties, consider that they contain default values if the properties are omitted from the `CustomProperties` parameter. The `PersistWBC` property has two possible values: **true** or **false**.

Setting the `PersistWBC` property to **true** does not delete the write-back cache disk when the Citrix Virtual Apps and Desktops administrator shuts down the machine using Web Studio.

Setting the `PersistWBC` property to **false** deletes the write-back cache disk when the Citrix Virtual Apps and Desktops administrator shuts down the machine using Web Studio.

**Note:**

If the `PersistWBC` property is omitted, the property defaults to **false** and the write-back cache is deleted when the machine is shutdown using Web Studio.

For example, using the `CustomProperties` parameter to set `PersistWBC` to true:

```

1 <CustomProperties xmlns="http://schemas.citrix.com/2014/xd/
 machinecreation" xmlns:xsi="http://www.w3.org/2001/XMLSchema-
 instance">
2 <Property xsi:type="StringProperty" Name="UseManagedDisks" Value="true"
 />
3 <Property xsi:type="StringProperty" Name="StorageAccountType" Value="
 Premium_LRS" />
4 <Property xsi:type="StringProperty" Name="ResourceGroups" Value="
 benva1dev5RG3" />
5 <Property xsi:type="StringProperty" Name="PersistWBC" Value="true" />
6 </CustomProperties>
7 <!--NeedCopy-->

```

**Important:**

The `PersistWBC` property can only be set using the `New-ProvScheme` PowerShell cmdlet. Attempting to alter the `CustomProperties` of a provisioning scheme after creation has no impact on the machine catalog and the persistence of the write-back cache disk when a machine is shut down.

For example, set `New-ProvScheme` to use the write-back cache while setting the `PersistWBC` property to true:

```

1 New-ProvScheme

```

```

2 -CleanOnBoot
3 -CustomProperties "<CustomProperties xmlns="http://schemas.citrix.com
 /2014/xd/machinecreation" xmlns:xsi="http://www.w3.org/2001/
 XMLSchema-instance"><Property xsi:type="StringProperty" Name="
 UseManagedDisks" Value="true" /><Property xsi:type="
 StringProperty" Name="StorageAccountType" Value="Premium_LRS"
 /><Property xsi:type="StringProperty" Name="ResourceGroups"
 Value="benvaldev5RG3" /><Property xsi:type="StringProperty" Name
 ="PersistWBC" Value="true" /></CustomProperties>"
4 -HostingUnitName "adSubnetScale1"
5 -IdentityPoolName "BV-WBC1-CAT1"
6 -MasterImageVM "XDHyp:\HostingUnits\adSubnetScale1\image.folder\
 GoldImages.resourcegroup\W10MCSI0-01
 _OsDisk_1_a940e6f5bab349019d57ccef65d2c7e3.manageddisk"
7 -NetworkMapping @{
8 "0"="XDHyp:\HostingUnits\adSubnetScale1\virtualprivatecloud.folder\
 CloudScale02.resourcegroup\adVNET.virtualprivatecloud\
 adSubnetScale1.network" }
9
10 -ProvisioningSchemeName "BV-WBC1-CAT1"
11 -ServiceOffering "XDHyp:\HostingUnits\adSubnetScale1\serviceoffering.
 folder\Standard_D2s_v3.serviceoffering"
12 -UseWriteBackCache
13 -WriteBackCacheDiskSize 127
14 -WriteBackCacheMemorySize 256
15 <!--NeedCopy-->

```

## Improve boot performance with MCSIO

You can improve boot performance for Azure and GCP managed disks when MCSIO is enabled. Use the PowerShell `PersistOsDisk` custom property in the `New-ProvScheme` command to configure this feature. Options associated with `New-ProvScheme` include:

```

1 <CustomProperties xmlns="http://schemas.citrix.com/2014/xd/
 machinecreation" xmlns:xsi="http://www.w3.org/2001/XMLSchema-
 instance">
2 <Property xsi:type="StringProperty" Name="UseManagedDisks" Value="true"
 />
3 <Property xsi:type="StringProperty" Name="StorageAccountType" Value="
 Premium_LRS" />
4 <Property xsi:type="StringProperty" Name="Resource <!--NeedCopy-->
  ``````<!--NeedCopy-->
5 <!--NeedCopy-->
6 <!--NeedCopy-->
7 ``````Groups" Value="benvaldev5RG3" />
8 <Property xsi:type="StringProperty" Name="PersistOsDisk" Value="true"
  />
9 </CustomProperties>
10 <!--NeedCopy-->

```

To enable this feature, set the `PersistOsDisk` custom property to **true**. For example:

```

1 New-ProvScheme
2 -CleanOnBoot
3 -CustomProperties "<CustomProperties xmlns='http://schemas.citrix.com
  /2014/xd/machinecreation`" xmlns:xsi='http://www.w3.org/2001/
  XMLSchema-instance`"><Property xsi:type='StringProperty`" Name='`"
  UseManagedDisks`" Value='`"true`" /><Property xsi:type='`"
  StringProperty`" Name='`"StorageAccountType`" Value='`"Premium_LRS`"
  /><Property xsi:type='StringProperty`" Name='`"ResourceGroups`"
  Value='`"benvaldev5RG3`" /><Property xsi:type='StringProperty`" Name
  ='`"PersistOsDisk`" Value='`"true`" /></CustomProperties>"
4 -HostingUnitName "adSubnetScale1"
5 -IdentityPoolName "BV-WBC1-CAT1"
6 -MasterImageVM "XDHyp:\HostingUnits\adSubnetScale1\image.folder\
  GoldImages.resourcegroup\W10MCSI0-01
  _OsDisk_1_a940e6f5bab349019d57ccef65d2c7e3.manageddisk"
7 -NetworkMapping @{
8   "0"="XDHyp:\HostingUnits\adSubnetScale1\virtualprivatecloud.folder\
  CloudScale02.resourcegroup\adVNET.virtualprivatecloud\
  adSubnetScale1.network" }
9
10 -ProvisioningSchemeName "BV-WBC1-CAT1"
11 -ServiceOffering "XDHyp:\HostingUnits\adSubnetScale1\serviceoffering.
  folder\Standard_D2s_v3.serviceoffering"
12 -UseWriteBackCache
13 -WriteBackCacheDiskSize 127
14 -WriteBackCacheMemorySize 256
15 <!--NeedCopy-->

```

Use template spec in creating or updating a catalog using PowerShell

You can create or update an MCS machine catalog using a template spec as a machine profile input. To do this, you can use the Web Studio or PowerShell commands.

For Web Studio, see [Create a machine catalog using an Azure Resource Manager image in Web Studio](#)

Using PowerShell commands:

1. Open the **PowerShell** window.
2. Run `asnp citrix*`.
3. Create or update a catalog.
 - To create a catalog:
 - a) Use the `New-ProvScheme` command with a template spec as a machine profile input. For example:

```

1 New-ProvScheme -MasterImageVM "XDHyp:/HostingUnits/azure/
  image.folder/fgthj.resourcegroup/nab-ws-
  vda_OsDisk_1_xxxxxxxxxxa.manageddisk"

```

```

2 MachineProfile "XDHyp:/HostingUnits/azure/machineprofile.
  folder/fgthj.resourcegroup/test.templatespec/V1.
  templatespecversion"
3 -ProvisioningSchemeName <String>
4 -HostingUnitName <String>
5 -IdentityPoolName <String>
6 [-ServiceOffering <String>][-CustomProperties <String>
7 [-LoggingId <Guid>]
8 [-BearerToken <String>][-AdminAddress <String>]
9 [<CommonParameters>]
10 <!--NeedCopy-->

```

b) Finish creating the catalog.

- To update a catalog, use `Set-ProvScheme` command with a template spec as a machine profile input. For example:

```

1 Set-ProvScheme -MasterImageVm 'XDHyp://Connections/Azure/East
  Us.region/vm.folder/MasterDisk.vm'
2 MachineProfile 'XDHyp:/HostingUnits/azure/machineprofile.
  folder/fgthj.resourcegroup/testing.templatespec/V1.
  templatespecversion'
3 [-ProvisioningSchemeName] <String>
4 [-CustomProperties <String>][-ServiceOffering <String>] [-
  PassThru]
5 [-LoggingId <Guid>] [-BearerToken <String>][-AdminAddress <
  String>] [<CommonParameters>]
6 <!--NeedCopy-->

```

Machine catalogs with trusted launch

To successfully create a machine catalog with trusted launch, use:

- A machine profile with trusted launch
- A VM size that supports trusted launch
- A Windows VM version that supports trusted launch. Currently, Windows 10, Windows 11, 2016, 2019, and 2022 support trusted launch.

Important:

MCS supports creating a new catalog with trusted launch enabled VMs. However, to update an existing persistent catalog and existing VMs, you have to use the Azure portal. You cannot update trusted launch of a non-persistent catalog. For more information, see the Microsoft document [Enable Trusted launch on existing Azure VMs](#).

To view the Citrix Virtual Apps and Desktops offering inventory items, and to determine whether the VM size supports trusted launch, run the following command:

1. Open a PowerShell window.

2. Run **asnp citrix*** to load the Citrix-specific PowerShell modules.
3. Run the following command:

```
1 $s = (ls XDHyp:\HostingUnits\\
    serviceoffering.folder\

```

4. Run `$s | select -ExpandProperty Additionaldata`
5. Check the value of the `SupportsTrustedLaunch` attribute.

- If `SupportsTrustedLaunch` is **True**, the VM size supports trusted launch.
- If `SupportsTrustedLaunch` is **False**, the VM size does not support trusted launch.

As per Azure's PowerShell, you can use the following command to determine the VM sizes that support trusted launch:

```
1 (Get-AzComputeResourceSku | where {
2   $_.Locations.Contains($region) -and ($_.Name -eq "<VM size>") }
3 ) [0].Capabilities
4 <!--NeedCopy-->
```

Following are examples that describe whether the VM size supports trusted launch after you run the Azure PowerShell command.

- *Example 1:* If the Azure VM supports only Generation 1, that VM does not support trusted launch. Therefore, the `TrustedLaunchDisabled` capability is not displayed after you run the Azure PowerShell command.
- *Example 2:* If the Azure VM supports only Generation 2 and the `TrustedLaunchDisabled` capability is **True**, the Generation 2 VM size is not supported for trusted launch.
- *Example 3:* If the Azure VM supports only Generation 2 and the `TrustedLaunchDisabled` capability is not displayed after you run the PowerShell command, the Generation 2 VM size is supported for trusted launch.

For more information on trusted launch for Azure virtual machines, see the Microsoft document [Trusted launch for Azure virtual machines](#).

Create a machine catalog with trusted launch

1. Create a master image enabled with trusted launch. See the Microsoft documentation [Trusted launch VM Images](#).
2. Create a VM or template spec with security type as **trusted launch virtual machines**. For more information on creating a VM or template spec, see the Microsoft document [Deploy a trusted launch VM](#).

3. Create a machine catalog using the Full Configuration interface or PowerShell commands.

- If you want to use the Full configuration interface, see [Create a machine catalog using an Azure Resource Manager image in the Full Configuration interface](#).
- If you want to use PowerShell commands, use the `New-ProvScheme` command with the VM or the template spec as a machine profile input. For the complete list of commands to create a catalog, see [Creating a catalog](#).

Example of `New-ProvScheme` with VM as machine profile input:

```

1 New-ProvScheme -CleanOnBoot -HostingUnitName "name" -
  IdentityPoolName "name" -InitialBatchSizeHint 1
2 -MasterImageVM "XDHyp:/HostingUnits/azure/image.folder/fgthj.
  resourcegroup/nab-ws-vda_0sDisk_1_XXXXXXXXXXa.manageddisk"
3 -MachineProfile "XDHyp:\HostingUnits\

```

Example of `New-ProvScheme` with template spec as machine profile input:

```

1 New-ProvScheme -CleanOnBoot -HostingUnitName "name" -
  IdentityPoolName "name" -InitialBatchSizeHint 1
2 -MasterImageVM "XDHyp:/HostingUnits/azure/image.folder/fgthj.
  resourcegroup/nab-ws-vda_0sDisk_1_XXXXXXXXXXa.manageddisk"
3 MachineProfile "XDHyp:/HostingUnits/azure/machineprofile.
  folder/fgthj.resourcegroup/test.templatespec/V1.
  templatespecversion"
4 -ProvisioningSchemeName <String>
5 -HostingUnitName <String>
6 -IdentityPoolName <String>
7 [-ServiceOffering <String>][--CustomProperties <String>]
8 [<CommonParameters>]
9 <!--NeedCopy-->

```

Errors while creating machine catalogs with Trusted launch

You get appropriate errors in the following scenarios while creating a machine catalog with trusted launch:

| Scenario | Error |
|---|---|
| If you select a machine profile while creating an unmanaged catalog | MachineProfileNotSupportedForUnmanagedCatalog |
| If you select a machine profile that supports Trusted launch while creating a catalog with unmanaged disk as the master image | SecurityTypeNotSupportedForUnmanagedDisk |
| If you do not select a machine profile while creating a managed catalog with a master image source with Trusted launch as the security type | MachineProfileNotFoundForTrustedLaunchMasterImage |
| If you select a machine profile with a security type different from the security type of the master image | SecurityTypeConflictBetweenMasterImageAndMachineProfile |
| If you select a VM size that does not support Trusted launch but use a master image that supports Trusted launch while creating a catalog | MachineSizeNotSupportTrustedLaunch |

Use machine profile property values

The machine catalog uses the following properties that are defined in the custom properties:

- Availability zone
- Dedicated Host Group Id
- Disk Encryption Set Id
- OS type
- License type
- Storage type

If these custom properties are not defined explicitly, then the property values are set from the ARM template spec or VM, whichever is used as the machine profile. In addition, if [ServiceOffering](#) is not specified, then it is set from the machine profile.

Note:

If some of the properties are missing from the machine profile and not defined in the custom properties, then the default values of the properties take place wherever applicable.

The following section describes some scenarios at [New-ProvScheme](#) and [Set-ProvScheme](#) when [CustomProperties](#) either have all the properties defined or values are derived from the MachineProfile.

- New-ProvScheme Scenarios

- MachineProfile has all the properties and CustomProperties are not defined. Example:

```
New-ProvScheme -MachineProfile "XDHyp:\HostingUnits\azureunit
\machineprofile.folder\azure.resourcegroup\mpA.vm"
```

The following values are set as custom properties for the catalog:

```
1 Get-ProvScheme | select CustomProperties
2 <CustomProperties xmlns="http://schemas.citrix.com/2014/xd/
  machinecreation" xmlns:xsi="http://www.w3.org/2001/
  XMLSchema-instance">
3 <Property xsi:type="StringProperty" Name="StorageAccountType"
  Value="<mpA-value>"/>
4 <Property xsi:type="StringProperty" Name="OSType" Value="<mpA
  -value>"/>
5 <Property xsi:type="StringProperty" Name="LicenseType" Value=
  "<mpA-value>"/>
6 <Property xsi:type="StringProperty" Name="DiskEncryptionSetId
  " Value="<mpA-value>"/>
7 <Property xsi:type="StringProperty" Name="
  DedicatedHostGroupId" Value="<mpA-value>"/>
8 <Property xsi:type="StringProperty" Name="Zones" Value="<mpA-
  value>"/>
9 </CustomProperties>
10 <!--NeedCopy-->
```

- MachineProfile has some properties and CustomProperties are not defined. Example: MachineProfile only has LicenseType and OsType.

```
New-ProvScheme -MachineProfile "XDHyp:\HostingUnits\azureunit
\machineprofile.folder\azure.resourcegroup\mpA.vm"
```

The following values are set as custom properties for the catalog:

```
1 Get-ProvScheme | select CustomProperties
2 <CustomProperties xmlns="http://schemas.citrix.com/2014/xd/
  machinecreation" xmlns:xsi="http://www.w3.org/2001/
  XMLSchema-instance">
3 <Property xsi:type="StringProperty" Name="OSType" Value="<mpA
  -value>"/>
4 <Property xsi:type="StringProperty" Name="LicenseType" Value=
  "<mpA-value>"/>
5 </CustomProperties>
6 <!--NeedCopy-->
```

- Both MachineProfile and CustomProperties define all properties. Example:

```
New-ProvScheme -MachineProfile "XDHyp:\HostingUnits\azureunit
\machineprofile.folder\azure.resourcegroup\mpA.vm"-CustomProperties
$CustomPropertiesA
```

Custom properties take priority. The following values are set as custom properties for the catalog:

```

1  Get-ProvScheme | select CustomProperties
2  <CustomProperties xmlns="http://schemas.citrix.com/2014/xd/
   machinecreation" xmlns:xsi="http://www.w3.org/2001/
   XMLSchema-instance">
3  <Property xsi:type="StringProperty" Name="StorageAccountType"
   Value="<CustomPropertiesA-value>"/>
4  <Property xsi:type="StringProperty" Name="OSType" Value="<
   CustomPropertiesA-value>"/>
5  <Property xsi:type="StringProperty" Name="LicenseType" Value=
   "<CustomPropertiesA-value>"/>
6  <Property xsi:type="StringProperty" Name="DiskEncryptionSetId
   " Value="<CustomPropertiesA-value>"/>
7  <Property xsi:type="StringProperty" Name="
   DedicatedHostGroupId" Value="<CustomPropertiesA-value>"/>
8  <Property xsi:type="StringProperty" Name="Zones" Value="<
   CustomPropertiesA-value>"/>
9  </CustomProperties>
10 <!--NeedCopy-->

```

- Some properties are defined in MachineProfile and some properties are defined in CustomProperties. Example:

- * CustomProperties define LicenseType and StorageAccountType
- * MachineProfile define LicenseType, OsType, and Zones

```

New-ProvScheme -MachineProfile "XDHyp:\HostingUnits\azureunit
\machineprofile.folder\azure.resourcegroup\mpA.vm"-CustomProperties
$CustomPropertiesA

```

The following values are set as custom properties for the catalog:

```

1  Get-ProvScheme | select CustomProperties
2  <CustomProperties xmlns="http://schemas.citrix.com/2014/xd/
   machinecreation" xmlns:xsi="http://www.w3.org/2001/
   XMLSchema-instance">
3  <Property xsi:type="StringProperty" Name="StorageAccountType"
   Value="<CustomPropertiesA-value>"/>
4  <Property xsi:type="StringProperty" Name="OSType" Value="<mpA
   -value>"/>
5  <Property xsi:type="StringProperty" Name="LicenseType" Value=
   "<CustomPropertiesA-value>"/>
6  <Property xsi:type="StringProperty" Name="Zones" Value="<mpA-
   value>"/>
7  </CustomProperties>
8  <!--NeedCopy-->

```

- Some properties are defined in MachineProfile and some properties are defined in CustomProperties. In addition, ServiceOffering is not defined. Example:

- * CustomProperties define StorageType
- * MachineProfile define LicenseType

```

1 New-ProvScheme -MachineProfile "XDHyp:\HostingUnits\azureunit
  \machineprofile.folder\azure.resourcegroup\mp.vm"
2 -ServiceOffering "XDHyp:\HostingUnits\azureunit\
  serviceoffering.folder\<explicit-machine-size>.
  serviceoffering"
3 <!--NeedCopy-->

```

The following values are set as custom properties for the catalog:

```

1 Get-ProvScheme | select ServiceOffering
2 serviceoffering.folder\<explicit-machine-size>.
  serviceoffering
3
4 Get-ProvScheme | select CustomProperties
5 <CustomProperties xmlns="http://schemas.citrix.com/2014/xd/
  machinecreation" xmlns:xsi="http://www.w3.org/2001/
  XMLSchema-instance">
6 <Property xsi:type="StringProperty" Name="StorageAccountType"
  Value="explicit-storage-type"/>
7 <Property xsi:type="StringProperty" Name="LicenseType" Value=
  "value-from-machineprofile"/>
8 </CustomProperties>
9 <!--NeedCopy-->

```

- If the OsType is in neither in the CustomProperties nor in the MachineProfile, then:

- * The value is read from the master image.
- * If the master image is an unmanaged disk, the OsType is set to Windows. Example:

```

New-ProvScheme -MachineProfile "XDHyp:\HostingUnits\azureunit
 \machineprofile.folder\azure.resourcegroup\mpA.vm"-MasterImageVM
 "XDHyp:\HostingUnits\azureunit\image.folder\linux-master-
 image.manageddisk"

```

The value from the master image is written to the custom properties, in this case Linux.

```

1 Get-ProvScheme | select CustomProperties
2 <CustomProperties xmlns="http://schemas.citrix.com/2014/xd/
  machinecreation" xmlns:xsi="http://www.w3.org/2001/
  XMLSchema-instance">
3 <Property xsi:type="StringProperty" Name="OSType" Value="
  Linux"/>
4 </CustomProperties>
5 <!--NeedCopy-->

```

- Set-ProvScheme Scenarios

- An existing catalog with:

- * CustomProperties for `StorageAccountType` and `OsType`
 - * MachineProfile `mpA . vm` that defines zones
- Updates:
- * MachineProfile `mpB . vm` that defines `StorageAccountType`
 - * A new set of custom properties `$CustomPropertiesB` that defines `LicenseType` and `OsType`

```
Set-ProvScheme -MachineProfile "XDHyp:\HostingUnits\azureunit
\machineprofile.folder\azure.resourcegroup\mpB . vm"-CustomProperties
$CustomPropertiesB
```

The following values are set as custom properties for the catalog:

```
1 Get-ProvScheme | select CustomProperties
2 <CustomProperties xmlns="http://schemas.citrix.com/2014/xd/
  machinecreation" xmlns:xsi="http://www.w3.org/2001/
  XMLSchema-instance">
3 <Property xsi:type="StringProperty" Name="StorageAccountType"
  Value="<mpB-value>"/>
4 <Property xsi:type="StringProperty" Name="OSType" Value="<
  CustomPropertiesB-value>"/>
5 <Property xsi:type="StringProperty" Name="LicenseType" Value=
  "<CustomPropertiesB-value>"/>
6 </CustomProperties>
7 <!--NeedCopy-->
```

- An existing catalog with:
- * CustomProperties for `StorageAccountType` and `OsType`
 - * MachineProfile `mpA . vm` that defines `StorageAccountType` and `LicenseType`
- Updates:
- * A new set of custom properties `$CustomPropertiesB` that defines `StorageAccountType` and `OsType`.

```
Set-ProvScheme -CustomProperties $CustomPropertiesB
```

The following values are set as custom properties for the catalog:

```
1 Get-ProvScheme | select CustomProperties
2 <CustomProperties xmlns="http://schemas.citrix.com/2014/xd/
  machinecreation" xmlns:xsi="http://www.w3.org/2001/
  XMLSchema-instance">
3 <Property xsi:type="StringProperty" Name="StorageAccountType"
  Value="<CustomPropertiesB-value>"/>
4 <Property xsi:type="StringProperty" Name="OSType" Value="<
  CustomPropertiesB-value>"/>
5 <Property xsi:type="StringProperty" Name="LicenseType" Value=
  "<mp-A-value>"/>
```

```
6 </CustomProperties>
7 <!--NeedCopy-->
```

- An existing catalog with:
 - * CustomProperties for `StorageAccountType` and `OsType`
 - * MachineProfile `mpA.vm` that defines Zones
- Updates:
 - * A MachineProfile `mpB.vm` that defines `StorageAccountType` and `LicenseType`
 - * `ServiceOffering` is not specified

```
Set-ProvScheme -MachineProfile "XDHyp:\HostingUnits\azureunit
\machineprofile.folder\azure.resourcegroup\mpB.vm"
```

The following values are set as custom properties for the catalog:

```
1 Get-ProvScheme | select ServiceOffering
2 serviceoffering.folder\<value-from-machineprofile>.
  serviceoffering
3
4 Get-ProvScheme | select CustomProperties
5 <CustomProperties xmlns="http://schemas.citrix.com/2014/xd/
  machinecreation" xmlns:xsi="http://www.w3.org/2001/
  XMLSchema-instance">
6 <Property xsi:type="StringProperty" Name="StorageAccountType"
  Value="<mpB-value>"/>
7 <Property xsi:type="StringProperty" Name="OsType" Value="<
  prior-CustomProperties-value>"/>
8 <Property xsi:type="StringProperty" Name="LicenseType" Value=
  "<mpB-value>"/>
9 </CustomProperties>
10 <!--NeedCopy-->
```

Provision catalog VMs with Azure Monitor Agent installed

Azure monitoring is a service which you can use to collect, analyze, and act on telemetry data from your Azure and on-premises environments.

Azure Monitor Agent (AMA) collects monitoring data from compute resources like virtual machines and delivers the data to Azure monitor. It currently supports the collection of Event Logs, Syslog and Performance metrics and sends it to Azure Monitor Metrics and Azure Monitor Logs data sources.

To enable monitoring by uniquely identifying the VMs in monitoring data, you can provision the VMs of an MCS machine catalog with AMA installed as an extension.

Requirements

- Permissions: Ensure that you have the minimum Azure permissions as specified in [About Azure permissions](#) and the following permissions to use Azure Monitor:
 - `Microsoft.Compute/virtualMachines/extensions/read`
 - `Microsoft.Compute/virtualMachines/extensions/write`
 - `Microsoft.Insights/DataCollectionRuleAssociations/Read`
 - `Microsoft.Insights/dataCollectionRuleAssociations/write`
 - `Microsoft.Insights/DataCollectionRules/Read`
- Data Collection Rule: Set up a data collection rule in Azure portal. For information about setting up a DCR, see [Create a data collection rule](#). A DCR is platform specific (Windows or Linux). Ensure that you create a DCR as per the required platform.

The AMA uses Data Collection Rules (DCR) to manage the mapping between the resources, such as VMs, and data sources, like Azure Monitor Metrics and Azure Monitor Logs.
- Default Workspace: Create a workspace in Azure portal. For information on creating a workspace, see [Create a Log Analytics workspace](#). When you collect logs and data, the information is stored in a workspace. A workspace has a unique workspace ID and resource ID. The workspace name must be unique for a given resource group. After you create a workspace, configure data sources and solutions to store their data in the workspace.
- Whitelisted the monitor extension: The extensions `AzureMonitorWindowsAgent` and `AzureMonitorLinuxAgent` are Citrix defined whitelisted extensions. To view the list of whitelisted extensions, use the PoSH command, `Get-ProvMetadataConfiguration`.
- Master Image: Microsoft recommends removing extensions from an existing machine before creating a new machine from it. If the extensions are not removed, it might lead to leftover files and unexpected behavior. For more information, see [If the VM is recreated from an existing VM](#).

To provision catalog VMs with AMA enabled:

1. Set up a machine profile template.
 - If you want to use a VM as a machine profile template:
 - a) Create a VM on Azure portal.
 - b) Power on the VM.
 - c) Add the VM to the data collection rule under **Resources**. This invokes agent installation on the template VM.

Note:

If you must create a Linux catalog, set up a Linux machine.

- If you want to use template spec as a machine profile template:
 - a) Set up a template spec.
 - b) Add the following extension and data collection rule association to the generated template spec:

```
1 {
2
3 "type": "Microsoft.Compute/virtualMachines/extensions",
4 "apiVersion": "2022-03-01",
5 "name": "<vm-name>/AzureMonitorWindowsAgent",
6 "dependsOn": [
7     "Microsoft.Compute/virtualMachines/<vm-name>"
8 ],
9 "location": "<azure-region>",
10 "properties": {
11
12     "publisher": "Microsoft.Azure.Monitor",
13     "type": "AzureMonitorWindowsAgent",
14     "typeHandlerVersion": "1.0",
15     "autoUpgradeMinorVersion": true,
16     "enableAutomaticUpgrade": true
17 }
18
19 }
20 ,
21 {
22
23     "type": "Microsoft.Insights/
24         dataCollectionRuleAssociations",
25     "apiVersion": "2021-11-01",
26     "name": "<associatio-name>",
27     "scope": "Microsoft.Compute/virtualMachines/<vm-name>",
28     "dependsOn": [
29         "Microsoft.Compute/virtualMachines/<vm-name>",
30         "Microsoft.Compute/virtualMachines/<vm-name>/extensions
31         /AzureMonitorWindowsAgent"
32     ],
33     "properties": {
34
35         "description": "Association of data collection rule.
36             Deleting this association will break the data
37             collection for this Arc server.",
38         "dataCollectionRuleId": "/subscriptions/<azure-
39             subscription>/resourcegroups/<azure-resource-group>/providers/microsoft.insights/datacollectionrules
40             /<azure-data-collection-rule>"
41     }
42 }
43
44 }
45
46 <!--NeedCopy-->
```

2. Create or update an existing MCS machine catalog.

- To create a new MCS catalog:
 - a) Select that VM or template spec as a machine profile in the Full Configuration interface.
 - b) Proceed with the next steps to create the catalog.
- To update an existing MCS catalog, use the following PoSH commands:
 - To have the new VMs get the updated machine profile template, run the following command:

```
1 Set-ProvScheme -ProvisioningSchemeName "name"  
2 -MachineProfile "XDHyp:\HostingUnits\Unit1\machineprofile.  
   folder\abc.resourcegroup\ab-machine-profile.vm"  
3 <!--NeedCopy-->
```

- To update existing VMs with the updated machine profile template:

```
1 Set-ProvVMUpdateTimeWindow -ProvisioningSchemeName my-  
   catalog -StartsNow -DurationInMinutes -1  
2 <!--NeedCopy-->
```

3. Power on catalog VMs.

4. Go to Azure portal and check if the monitor extension is installed on the VM and the VM is showing up under DCR's Resources. After a few minutes monitoring data is displayed on the Azure Monitor.

Troubleshooting

For information in troubleshooting guidance for Azure Monitor Agent, see the following:

- <https://learn.microsoft.com/en-us/azure/azure-monitor/agents/azure-monitor-agent-troubleshoot-windows-vm/>
- <https://learn.microsoft.com/en-us/azure/azure-resource-manager/troubleshooting/create-troubleshooting-template/>

Create a machine catalog with customer-managed encryption key

The detailed steps on how to create a machine catalog with customer-managed encryption key are:

1. Open a PowerShell window.
2. Run `asnp citrix*` to load the Citrix-specific PowerShell modules.

3. Enter `cd xdhyp:/`.
4. Enter `cd .\HostingUnits\<(your hosting unit)`.
5. Enter `cd diskencryptionset.folder`.
6. Enter `dir` to get the list of the Disk Encryption Sets.
7. Copy the Id of a Disk Encryption Set.
8. Create a custom property string to include the Id of the Disk Encryption Set. For example:

```

1 $customProperties = "<CustomProperties xmlns='http://schemas.
   citrix.com/2014/xd/machinecreation' xmlns:xsi='http://www.w3.
   org/2001/XMLSchema-instance'">
2 <Property xsi:type='StringProperty' Name='StorageAccountType'
   Value='Standard_LRS' />
3 <Property xsi:type='StringProperty' Name='persistWBC' Value='
   False' />
4 <Property xsi:type='StringProperty' Name='PersistOsDisk' Value
   ='false' />
5 <Property xsi:type='StringProperty' Name='UseManagedDisks'
   Value='true' />
6 <Property xsi:type='StringProperty' Name='DiskEncryptionSetId'
   Value='/subscriptions/0xxx4xxx-xxb-4bxx-xxxx-xxxxxxx/
   resourceGroups/abc/providers/Microsoft.Compute/
   diskEncryptionSets/abc-des' />
7 </CustomProperties>
8 <!--NeedCopy-->

```

9. Create an identity pool if not already created. For example:

```

1 New-AcctIdentityPool -IdentityPoolName idPool -NamingScheme ms## -
   Domain def.local -NamingSchemeType Numeric
2 <!--NeedCopy-->

```

10. Run the `New-ProvScheme` command: For example:

```

1 New-ProvScheme -CleanOnBoot -HostingUnitName "name" -
   IdentityPoolName "name" -InitialBatchSizeHint 1
2 -MasterImageVM "XDhyp:\HostingUnits\azure-res2\image.folder\def.
   resourcegroup\def.snapshot"
3 -NetworkMapping @{
4   "0"="XDhyp:\HostingUnits\azure-res2\virtualprivatecloud.folder\
   def.resourcegroup\def-vnet.virtualprivatecloud\subnet1.network
   " }
5
6 -ProvisioningSchemeName "name"
7 -ServiceOffering "XDhyp:\HostingUnits\azure-res2\serviceoffering.
   folder\Standard_DS2_v2.serviceoffering"
8 -MachineProfile "XDhyp:\HostingUnits\<adnet>\machineprofile.folder
   \<def.resourcegroup>\<machine profile vm.vm>"
9 -CustomProperties $customProperties
10 <!--NeedCopy-->

```

11. Finish creating the machine catalog.

Create a machine catalog with double encryption

You can create and update a machine catalog with double encryption using Web Studio and PowerShell commands.

The detailed steps on how to create a machine catalog with double encryption are:

1. Create an Azure Key Vault and DES with Platform-managed and customer-managed keys. For information on how to create an Azure Key Vault and a DES, see [Use the Azure portal to enable double encryption at rest for managed disks](#).
2. To browse available DiskEncryptionSets in your hosting connection:
 - a) Open a **PowerShell** window.
 - b) Run the following PowerShell commands:
 - i. `asnp citrix*`
 - ii. `cd xdhyp:`
 - iii. `cd HostingUnits`
 - iv. `cd YourHostingUnitName` (ex. azure-east)
 - v. `cd diskencryptionset.folder`
 - vi. `dir`

You can use an Id of the `DiskEncryptionSet` to create or update a catalog using custom properties.

3. If you want to use machine profile workflow, create a VM or template spec as a machine profile input.
 - If you want to use a VM as a machine profile input:
 - a) Create a VM in Azure Portal.
 - b) Navigate to **Disks>Key management** to encrypt the VM directly with any `DiskEncryptionSetID`.
 - If you want to use a template spec as a machine profile input:
 - a) In the template, under `properties>storageProfile>osDisk>managedDisk`, add `diskEncryptionSet` parameter and add the id of the double encryption DES.
4. Create the machine catalog.
 - If using Web Studio, do one of the following in addition to the steps in [Create machine catalogs](#).

- If you do not use machine profile-based workflow, on the **Disk Settings** page, select **Use the following key to encrypt data on each machine**. Then, select your double encryption DES from the dropdown. Continue creating the catalog.
- If using machine profile workflow, on the **Image** page, select a master image and a machine profile. Make sure that the machine profile has a disk encryption set id in its properties.

All machines created in the catalog are double encrypted by the key associated with the DES you selected.

- If using PowerShell commands, do one of the following:
 - If not using machine profile-based workflow, add the custom property `DiskEncryptionSetId` in the `New-ProvScheme` command. For example:

```

1  New-ProvScheme -CleanOnBoot -CustomProperties '<
      CustomProperties xmlns="http://schemas.citrix.com/2014/
      xd/machinecreation" xmlns:xsi="http://www.w3.org/2001/
      XMLSchema-instance">
2  <Property xsi:type="StringProperty" Name="UseManagedDisks"
      Value="true" />
3  <Property xsi:type="StringProperty" Name="
      StorageAccountType" Value="Premium_LRS" />
4  <Property xsi:type="StringProperty" Name="
      DiskEncryptionSetId" Value="/subscriptions/12345678-
      xxxx-1234-1234-123456789012/resourceGroups/Sample-RG/
      providers/Microsoft.Compute/diskEncryptionSets/
      SampleEncryptionSet" />
5  </CustomProperties>'
6  -HostingUnitName "Redacted"
7  -IdentityPoolName "Redacted"
8  -InitialBatchSizeHint 1
9  -MasterImageVM "Redacted"
10 -NetworkMapping @{
11 "0"="Redacted" }
12
13 -ProvisioningSchemeName "Redacted"
14 -ServiceOffering "Redacted"
15 <!--NeedCopy-->

```

- If using machine profile-based workflow, use a machine profile input in the `New-ProvScheme` command. For example:

```

1  New-ProvScheme -CleanOnBoot
2  -HostingUnitName azure-east
3  -IdentityPoolName aio-ip
4  -InitialBatchSizeHint 1
5  -MasterImageVM XDHyp:\HostingUnits\azure-east\image.folder
      \abc.resourcegroup\fgb-vda-snapshot.snapshot
6  -NetworkMapping @{
7  "0"="XDHyp:\HostingUnits\azure-east\virtualprivatecloud.

```

```

        folder\apa-resourceGroup.resourcegroup\apa-
        resourceGroup-vnet.virtualprivatecloud\default.network"
    }
8
9 -ProvisioningSchemeName aio-test
10 -MachineProfile XDHyp:\HostingUnits\azure-east\
    machineprofile.folder\abc.resourcegroup\abx-mp.
    templatespec\1.0.0.templatespecversion
11 <!--NeedCopy-->

```

5. Finish creating a catalog using remote PowerShell SDK. For information on how to create a catalog using the Remote PowerShell SDK, see <https://developer-docs.citrix.com/projects/citrix-virtual-apps-desktops-sdk/en/latest/creating-a-catalog/>. All machines created in the catalog are double encrypted by the key associated with the DES you selected.

Convert an unencrypted catalog to use double encryption

You can update a machine catalog's encryption type (using custom properties or machine profile) only if the catalog was previously unencrypted.

- If not using machine profile-based workflow, add the custom property `DiskEncryptionSetId` in the `Set-ProvScheme` command. For example:

```

1 Set-ProvScheme -ProvisioningSchemeName "SampleProvSchemeName"
2 -CustomProperties '<CustomProperties xmlns="http://schemas.citrix
    .com/2014/xd/machinecreation" xmlns:xsi="http://www.w3.org
    /2001/XMLSchema-instance">
3 <Property xsi:type="StringProperty" Name="DiskEncryptionSetId"
    Value="/subscriptions/12345678-xxxx-1234-1234-123456789012/
    resourceGroups/Sample-RG/providers/Microsoft.Compute/
    diskEncryptionSets/SampleEncryptionSet" />
4 </CustomProperties>'
5 <!--NeedCopy-->

```

- If using machine profile-based workflow, use a machine profile input in the `Set-ProvScheme` command. For example:

```

1 Set-ProvScheme -ProvisioningSchemeName mxiao-test -MachineProfile
    XDHyp:\HostingUnits\azure-east\machineprofile.folder\aelx.
    resourcegroup\elx-mp.templatespec\1.0.0.templatespecversion
2 <!--NeedCopy-->

```

Once successful, all new VMs that you add in your catalog are double encrypted by the key associated with the DES you selected.

Verify the catalog is double encrypted

- In the Web Studio:
 1. Navigate to **Machine Catalogs**.
 2. Select the catalog you want to verify. Click the **Template Properties** tab located near the bottom of the screen.
 3. Under **Azure Details**, verify the Disk Encryption Set ID in **Disk Encryption Set**. If the catalog's DES Id is blank, the catalog is not encrypted.
 4. In the Azure Portal, verify that the encryption type of the DES associated with the DES Id is platform-managed and customer-managed keys.

- Using PowerShell command:

1. Open the **PowerShell** window.
2. Run `asnp citrix*` to load the Citrix-specific PowerShell modules.
3. Use `Get-ProvScheme` to get the information of your machine catalog. For example:

```
1 Get-ProvScheme -ProvisioningSchemeName "SampleProvSchemeName"
2 <!--NeedCopy-->
```

4. Retrieve the DES Id custom property of the machine catalog. For example:

```
1 <Property xsi:type="StringProperty" Name="DiskEncryptionSetId"
  Value="/subscriptions
  /12345678-1234-1234-1234-123456789012/resourceGroups/Sample
  -RG/providers/Microsoft.Compute/diskEncryptionSets/
  SampleEncryptionSet" />
2 <!--NeedCopy-->
```

5. In the Azure Portal, verify that the encryption type of the DES associated with the DES Id is platform-managed and customer-managed keys.

Create a catalog with an Azure ephemeral disks

To use ephemeral disks, you must set the custom property `UseEphemeralOsDisk` to **true** when running `New-ProvScheme`.

Note:

If the custom property `UseEphemeralOsDisk` is set to **false** or a value is not specified all provisioned VDAs continue to use a provisioned OS disk.

The following is an example set of custom properties to use in the provisioning scheme:

```
1  "CustomProperties": [  
2      {  
3  
4          "Name": "UseManagedDisks",  
5          "Value": "true"  
6      }  
7  ,  
8      {  
9  
10         "Name": "StorageType",  
11         "Value": "Standard_LRS"  
12     }  
13  ,  
14     {  
15  
16         "Name": "UseSharedImageGallery",  
17         "Value": "true"  
18     }  
19  ,  
20     {  
21  
22         "Name": "SharedImageGalleryReplicaRatio",  
23         "Value": "40"  
24     }  
25  ,  
26     {  
27  
28         "Name": "SharedImageGalleryReplicaMaximum",  
29         "Value": "10"  
30     }  
31  ,  
32     {  
33  
34         "Name": "LicenseType",  
35         "Value": "Windows_Server"  
36     }  
37  ,  
38     {  
39  
40         "Name": "UseEphemeralOsDisk",  
41         "Value": "true"  
42     }  
43  
44     ],  
45 <!--NeedCopy-->
```

Configure an ephemeral disk for a catalog

To configure an Azure ephemeral OS disk for a catalog, use the `UseEphemeralOsDisk` parameter in `Set-ProvScheme`. Set the value of the `UseEphemeralOsDisk` parameter to **true**.

Note:

To use this feature, you must also enable the parameters `UseManagedDisks` and `UseSharedImageGallery`.

For example:

```
1 Set-ProvScheme -ProvisioningSchemeName catalog-name -CustomProperties <  
  CustomProperties xmlns="http://schemas.citrix.com/2014/xd/  
  machinecreation" xmlns:xsi="http://www.w3.org/2001/XMLSchema-  
  instance">  
2 <Property xsi:type="StringProperty" Name="UseManagedDisks" Value="true"  
  />  
3 <Property xsi:type="StringProperty" Name="UseSharedImageGallery" Value=  
  "true" />  
4 <Property xsi:type="StringProperty" Name="UseEphemeralOsDisk" Value="  
  true" />  
5 </CustomProperties>'  
6 <!--NeedCopy-->
```

Important considerations for ephemeral disks

To provision ephemeral OS disks using `New-ProvScheme`, consider the following constraints:

- The VM size used for the catalog must support ephemeral OS disks.
- The size of the cache or temporary disk associated with the VM size must be greater than or equal to the size of the OS disk.
- The temporary disk size must be greater than the cache disk size.

Also consider these issues when:

- Creating the provisioning scheme.
- Modifying the provisioning scheme.
- Updating the image.

Azure dedicated hosts

You can use MCS to provision VMs on Azure dedicated hosts. Before provisioning VMs on Azure dedicated hosts:

- Create a host group.
- Create hosts in that host group.
- Ensure that there is sufficient host capacity reserved for creating catalogs and virtual machines.

You can create a catalog of machines with host tenancy defined through the following PowerShell script:

```
1 New-ProvScheme <otherParameters> -CustomProperties '<CustomProperties
  xmlns="http://schemas.citrix.com/2014/xd/machinecreation" xmlns:xsi
  ="http://www.w3.org/2001/XMLSchema-instance">
2   <Property xsi:type="StringProperty" Name="HostGroupId" Value="
    myResourceGroup/myHostGroup" />
3   ...other Custom Properties...
4 </CustomProperties>
5 <!--NeedCopy-->
```

When using MCS to provision virtual machines on Azure dedicated hosts, consider:

- A *Dedicated host* is a catalog property and cannot be changed once the catalog is created. Dedicated tenancy is currently not supported on Azure.
- A pre-configured Azure host group, in the region of the hosting unit, is required when using the `HostGroupId` parameter.
- Azure auto-placement is required. This functionality makes a request to onboard the subscription associated with the host group. For more information, see [VM Scale Set on Azure Dedicated Hosts - Public Preview](#). If auto-placement is not enabled, MCS throws an error during catalog creation.

Create or update a machine catalog using an Azure Compute Gallery image

When selecting an image to use for creating a machine catalog, you can select images you created in the Azure Compute Gallery.

For these images to appear, you must:

1. Configure a Citrix Virtual Apps and Desktops site.
2. Connect to the Azure Resource Manager.
3. In the Azure portal, create a resource group. For details, see [Create an Azure Compute Gallery using the portal](#).
4. In the resource group, create an Azure Compute Gallery.
5. In the Azure Compute Gallery, create an image definition.
6. In the image definition, create an image version.

Use the following PowerShell commands to create or update a machine catalog using an image from Azure Compute Gallery:

1. Open a PowerShell window.
2. Run `asnp citrix*` to load the Citrix-specific PowerShell modules.
3. Select a resource group, and then list all galleries of that resource group.

```
1 Get-ChildItem -LiteralPath @("XDHyp:\HostingUnits\testresource\
  image.folder\sharedImageGalleryTest.resourcegroup")
```



```
2 <!--NeedCopy-->
```

4. Select a gallery, and then list all image definitions of that gallery.

```
1 Get-ChildItem -LiteralPath @"(\"XDHyp:\HostingUnits\testresource\  
  image.folder\sharedImageGalleryTest.resourcegroup\  
  sharedImageGallery.sharedimagegallery")  
2 <!--NeedCopy-->
```

5. Select one image definition, and then list all image versions of that image definition.

```
1 Get-ChildItem -LiteralPath @"(\"XDHyp:\HostingUnits\testresource\  
  image.folder\sharedImageGalleryTest.resourcegroup\  
  sharedImageGallery.sharedimagegallery\sigttestimage.  
  imagedefinition")  
2 <!--NeedCopy-->
```

6. Create and update an MCS catalog using the following elements:

- Resource group
- Gallery
- Gallery image definition
- Gallery image version

For information on how to create a catalog using the Remote PowerShell SDK, see <https://developer-docs.citrix.com/projects/citrix-virtual-apps-desktops-sdk/en/latest/creating-a-catalog/>.

Configure Shared Image Gallery

Use the `New-ProvScheme` command to create a provisioning scheme with Shared Image Gallery support. Use the `Set-ProvScheme` command to enable or disable this feature for a provisioning scheme and to change the replica ratio and replica maximum values.

Three custom properties were added to provisioning schemes to support the Shared Image Gallery feature:

`UseSharedImageGallery`

- Defines whether to use the Shared Image Gallery to store the published images. If set to **True**, the image is stored as a Shared Image Gallery image, otherwise the image is stored as a snapshot.
- Valid values are **True** and **False**.
- If the property is not defined, the default value is **False**.

`SharedImageGalleryReplicaRatio`

- Defines the ratio of machines to gallery image version replicas.

- Valid values are integer numbers greater than 0.
- If the property is not defined, default values are used. The default value for persistent OS disks is 1000 and the default value for non-persistent OS disks is 40.

SharedImageGalleryReplicaMaximum

- Defines the maximum number of replicas for each gallery image version.
- Valid values are integer numbers greater than 0.
- If the property is not defined, the default value is 10.
- Azure currently supports up to 10 replicas for a gallery image single version. If the property is set to a value greater than that supported by Azure, MCS attempts to use the specified value. Azure generates an error, which MCS logs then leaves the current replica count unchanged.

Tip:

When using Shared Image Gallery to store a published image for MCS provisioned catalogs, MCS sets the gallery image version replica count based on the number of machines in the catalog, the replica ratio, and the replica maximum. The replica count is calculated by dividing the number of machines in the catalog by the replica ratio (rounding up to the nearest integer value) and then capping the value at the maximum replica count. For example, with a replica ratio of 20 and a maximum of 5, 0–20 machines have one replica created, 21–40 have 2 replicas, 41–60 have 3 replicas, 61–80 have 4 replicas, 81+ have 5 replicas.

Use case: Updating the Shared Image Gallery replica ratio and replica max

The existing machine catalog uses Shared Image Gallery. Use the `Set-ProvScheme` command to update the custom properties for all existing machines in the catalog and any future machines:

```
1 Set-ProvScheme -ProvisioningSchemeName catalog-name -CustomProperties '
  <CustomProperties xmlns="http://schemas.citrix.com/2014/xd/
  machinecreation" xmlns:xsi="http://www.w3.org/2001/XMLSchema-
  instance"> <Property xsi:type="StringProperty" Name="StorageType"
  Value="Standard_LRS"/> <Property xsi:type="StringProperty" Name="
  UseManagedDisks" Value="True"/> <Property xsi:type="StringProperty"
  Name="UseSharedImageGallery" Value="True"/> <Property xsi:type="
  IntProperty" Name="SharedImageGalleryReplicaRatio" Value="30"/> <
  Property xsi:type="IntProperty" Name="
  SharedImageGalleryReplicaMaximum" Value="20"/></CustomProperties>'
2 <!--NeedCopy-->
```

Use Case: Converting a snapshot catalog to a Shared Image Gallery catalog

For this use case:

1. Run `Set-ProvScheme` with the `UseSharedImageGallery` flag set to **True**. Optionally include the `SharedImageGalleryReplicaRatio` and `SharedImageGalleryReplicaMaximum` properties.
2. Update the catalog.
3. Power cycle the machines to force an update.

For example:

```
1 Set-ProvScheme -ProvisioningSchemeName catalog-name -CustomProperties '
  <CustomProperties xmlns="http://schemas.citrix.com/2014/xd/
  machinecreation" xmlns:xsi="http://www.w3.org/2001/XMLSchema-
  instance"> <Property xsi:type="StringProperty" Name="StorageType"
  Value="Standard_LRS"/> <Property xsi:type="StringProperty" Name="
  UseManagedDisks" Value="True"/> <Property xsi:type="StringProperty"
  Name="UseSharedImageGallery" Value="True"/> <Property xsi:type="
  IntProperty" Name="SharedImageGalleryReplicaRatio" Value="30"/> <
  Property xsi:type="IntProperty" Name="
  SharedImageGalleryReplicaMaximum" Value="20"/></CustomProperties>'
2 <!--NeedCopy-->
```

Tip:

The parameters `SharedImageGalleryReplicaRatio` and `SharedImageGalleryReplicaMaximum` are not required. After the `Set-ProvScheme` command completes the Shared Image Gallery image has not yet been created. Once the catalog is configured to use the gallery, the next catalog update operation stores the published image in the gallery. The catalog update command creates the gallery, the gallery image, and the image version. Power cycling the machines updates them, at which point the replica count is updated, if appropriate. From that time, all existing non-persistent machines are reset using the Shared Image Gallery image and all newly provisioned machines are created using the image. The old snapshot is cleaned up automatically within a few hours.

Use Case: Converting a Shared Image Gallery Catalog to a snapshot catalog

For this use case:

1. Run `Set-ProvScheme` with the `UseSharedImageGallery` flag set to **False** or not defined.
2. Update the catalog.
3. Power cycle the machines to force an update.

For example:

```
1 Set-ProvScheme -ProvisioningSchemeName catalog-name -CustomProperties '
  <CustomProperties xmlns="http://schemas.citrix.com/2014/xd/
  machinecreation" xmlns:xsi="http://www.w3.org/2001/XMLSchema-
  instance"> <Property xsi:type="StringProperty" Name="StorageType"
```

```
Value="Standard_LRS"/> <Property xsi:type="StringProperty" Name="
  UseManagedDisks" Value="True"/> <Property xsi:type="StringProperty"
  Name="UseSharedImageGallery" Value="False"/></CustomProperties>'
2 <!--NeedCopy-->
```

Tip:

Unlike updating from a snapshot to a Shared Image Gallery catalog, the custom data for each machine is not yet updated to reflect the new custom properties. Run the following command to see the original Shared Image Gallery custom properties: `Get-ProvVm -ProvisioningSchemeName catalog-name`. After the `Set-ProvScheme` command completes the image snapshot has not yet been created. Once the catalog is configured to not use the gallery, the next catalog update operation stores the published image as a snapshot. From that time, all existing non-persistent machines are reset using the snapshot and all newly provisioned machines are created from the snapshot. Power cycling the machines updates them, at which point the custom machine data is updated to reflect that `UseSharedImageGallery` is set to **False**. The old Shared Image Gallery assets (gallery, image, and version) are automatically cleaned up within a few hours.

Provision machines into specified Availability Zones

You can provision machines into specific Availability Zones in Azure environments. You can achieve that using the PowerShell.

Note:

If no zones are specified, MCS lets Azure place the machines within the region. If more than one zone is specified, MCS randomly distributes the machines across them.

Configure Availability Zones through PowerShell

Using PowerShell, you can view the offering inventory items by using `Get-Item`. For example, to view the *Eastern US region Standard_B1ls* service offering:

```
1 $serviceOffering = Get-Item -path "XDHyp:\Connections\my-connection-
  name\East US.region\serviceoffering.folder\Standard_B1ls.
  serviceoffering"
2 <!--NeedCopy-->
```

To view the zones, use the `AdditionalData` parameter for the item:

```
$serviceOffering.AdditionalData
```

If Availability Zones are not specified, there is no change in how machines are provisioned.

To configure Availability Zones through PowerShell, use the **Zones** custom property available with the `New-ProvScheme` operation. The **Zones** property defines a list of Availability Zones to provision machines into. Those zones can include one or more Availability Zones. For example, `<Property xsi:type="StringProperty"Name="Zones"Value="1, 3"/>` for Zones 1 and 3.

Use the `Set-ProvScheme` command to update the zones for a provisioning scheme.

If an invalid zone is provided, the provisioning scheme is not updated, and an error message appears providing instructions on how to fix the invalid command.

Tip:

If you specify an invalid custom property, the provisioning scheme is not updated and a relevant error message appears.

Storage types

Select different storage types for virtual machines in Azure environments that use MCS. For target VMs, MCS supports:

- OS disk: premium SSD, SSD, or HDD
- Write back cache disk: premium SSD, SSD, or HDD

When using these storage types, consider the following:

- Ensure that your VM supports the selected storage type.
- If your configuration uses an Azure ephemeral disk, you do not get the option for write-back cache disk setting.

Tip:

`StorageType` is configured for an OS type and storage account. `WBCDiskStorageType` is configured for write-back cache storage type. For a normal catalog, `StorageType` is required. If `WBCDiskStorageType` is not configured, the `StorageType` is used as the default for `WBCDiskStorageType`.

If `WBCDiskStorageType` is not configured, then `StorageType` is used as the default for `WBCDiskStorageType`

Configure storage types

To configure storage types for VM, use the `StorageType` parameter in `New-ProvScheme`. Set the value of the `StorageType` parameter to one of the supported storage types.

The following is an example set of the `CustomProperties` parameter in a provisioning scheme:

```
1 Set-ProvScheme -ProvisioningSchemeName catalog-name -CustomProperties '  
    <CustomProperties xmlns="http://schemas.citrix.com/2014/xd/  
    machinecreation" xmlns:xsi="http://www.w3.org/2001/XMLSchema-  
    instance">  
2 <Property xsi:type="StringProperty" Name="UseManagedDisks" Value="true"  
    />  
3 <Property xsi:type="StringProperty" Name="StorageType" Value="  
    Premium_LRS" />  
4 <Property xsi:type="StringProperty" Name="LicenseType" Value="  
    Windows_Client" />  
5 </CustomProperties>'  
6 <!--NeedCopy-->
```

Enable zone-redundant storage

You can select zone-redundant storage during catalog creation. It synchronously replicates your Azure managed disk across multiple availability zones, which allows you to recover from a failure in one zone by utilizing the redundancy in others.

You can specify **Premium_ZRS** and **StandardSSD_ZRS** in the storage type custom properties. ZRS storage can be set using existing custom properties or through the **MachineProfile** template. ZRS storage is also supported with `Set-ProvVMUpdateTimeWindow` command with `-StartsNow` and `-DurationInMinutes -1` parameters, and you can change existing machine from LRS to ZRS storage.

Limitations:

- Supported only for managed disks
- Supported only with premium and standard solid-state drives (SSD)
- Not supported with `StorageTypeAtShutdown`
- Available only in certain regions.
- Performance of Azure drops when creating ZRS disks at scale. Therefore, for the first power on, turn on the machines in smaller batches (less than 300 machines at a time)

Set zone-redundant storage as the disk storage type You can select zone-redundant storage during the initial catalog creation, or you can update your storage type in an existing catalog.

Select zone-redundant storage using PowerShell commands When creating a new catalog in Azure using the `New-ProvScheme` PowerShell command, use `Standard_ZRS` as the value in the `StorageAccountType`.

For example:

```
1 <Property xsi:type="StringProperty" Name="StorageAccountType" Value="
  StandardSSD_ZRS" />
2 <!--NeedCopy-->
```

When setting this value, it is validated by a dynamic API that determines if it can be used properly. The following exceptions can occur if the use of ZRS is not valid for your catalog:

- **StorageTypeAtShutdownNotSupportedForZrsDisks:** The `StorageTypeAtShutdown` custom property cannot be used with ZRS storage.
- **StorageAccountTypeNotSupportedInRegion:** This exception occurs if you try to use ZRS Storage in an Azure Region that does not support ZRS
- **ZrsRequiresManagedDisks:** You can use zone-redundant storage only with managed disks.

You can set the disk storage type using the following custom properties:

- `StorageType`
- `WBCDiskStorageType`
- `IdentityDiskStorageType`

Note:

During catalog creation, the machine profile's OS disk `StorageType` is used if the custom properties are not set.

Capture diagnostic settings on VMs and NICs from a machine profile

You can capture diagnostic settings on VMs and NICs from a machine profile while creating a machine catalog, updating an existing machine catalog, and updating existing VMs.

You can create a VM or template spec as a machine profile source.

Key steps

1. Set up required IDs in Azure. You must provide these IDs in the template spec.
 - Storage account
 - Log analytics workspace
 - Event hub namespace with the standard tier pricing
2. Create machine profile source.
3. Create a new machine catalog, update an existing catalog, or update existing VMs.

Set up required IDs in Azure

Set up one of the following in Azure:

- Storage account
- Log analytics workspace
- Event hub namespace with the Standard tier pricing

Set up a storage account Create a standard storage account in Azure. In the template spec, give the full resourceId for the storage account as the `storageAccountId`.

Once VMs are set up to log data to the storage account, the data can be found under the `insights-metrics-pt1m` container.

Set up a log analytics workspace Create a log analytics workspace. In the template spec, give the full resourceId for the log analytics workspace as the `workspaceId`.

Once VMs are set up to log data to the workspace, data can be queried under Logs in Azure. You can run the following command in Azure under Logs to show a count of all the metrics logged by a resource:

```
AzureMetrics | summarize Count=count()by ResourceId
```

Set up an event hub Do the following to set up an event hub in Azure portal:

1. Create an event hub namespace with the standard tier pricing.
2. Create an event hub underneath the namespace.
3. Navigate to **Capture** under the event hub. Switch ON the toggle to capture with the Avro output type.
4. Create a new container in an existing storage account to capture the logs.
5. In the template spec, specify the `eventHubAuthorizationRuleId` in the following format: `/subscriptions/093f4c12-704b-4b1d-8339-f339e7557f60/resourcegroups/matspo/providers/Microsoft.EventHub/namespaces/matspoeventhub/authorizationrules/RootManageSharedAccessKey`
6. Specify the name of the event hub.

Once VMs are set up to log data to the event hub, the data is captured into the configured storage container.

Create a machine profile source

You can create a VM or template spec as a machine profile source.

Create a VM based machine profile with diagnostic settings If you want to create a VM as your machine profile, then first set up diagnostic settings on the template VM itself. You can refer to the detailed instructions provided in the Microsoft documentation [Diagnostic settings in Azure Monitor](#).

You can run the following commands to verify that there are now diagnostic settings associated with the VM or NIC:

```
1 az monitor diagnostic-settings list --resource-group matspo --resource
  matspo-tog-cc2659 --resource-type microsoft.network/
  networkInterfaces
2 <!--NeedCopy-->
```

```
1 az monitor diagnostic-settings list --resource-group matspo --resource
  matspo-tog-cc2 --resource-type microsoft.compute/virtualMachines
2 <!--NeedCopy-->
```

Create a template spec-based machine profile with diagnostic settings If you want to use a VM that already has diagnostic settings enabled and export it into an ARM template spec, these settings won't be automatically included within the template. You must manually add or modify diagnostic settings within the ARM template.

However, if you want a VM as your machine profile, MCS ensures that the critical diagnostic settings are accurately captured and applied to the resources within your MCS catalog.

1. Create a standard template spec that defines a VM and NIC(s).
2. Add additional resources to deploy the diagnostic settings according to the spec: [Microsoft.Insights diagnosticSettings](#). For scope, reference either a VM or NIC that's in the template by name with a partial ID. For example, for creating diagnostic settings attached to a VM named test-VM in the template spec, specify the scope as:

```
1 "scope": "microsoft.compute/virtualMachines/test-VM",
2 <!--NeedCopy-->
```

3. Use the template spec as a machine profile source.

Create or update a catalog with diagnostic settings

After you create a machine profile source, you can now create a machine catalog using [New-ProvScheme](#) command, update an existing machine catalog using [Set-ProvScheme](#) command, and update existing VMs using [Request-ProvVMUpdate](#) command.

Page file location

In Azure environments, the page file is set up to an appropriate location when the VM is first created. The paging file setting is configured in the format `<page file location>[min size] [max size]` (the size is in MB). For more information, see the Microsoft document [How to determine the appropriate page file](#).

When you create `ProvScheme` during image preparation, MCS determines the page file location based on certain rules. After you create `ProvScheme`:

- VM size change is blocked if the incoming VM size causes the page file setting to be different.
- Machine profile update is blocked if the service offering is changed because of the machine profile update causing page file setting to be different.
- Ephemeral OS disk (EOS) and MCSIO properties cannot be changed.

Page file location determination

The features like EOS and MCSIO have their own expected page file location and are exclusive to each other. The table shows the expected page file location for each feature:

| Feature | Expected page file location |
|---------|---|
| EOS | OS disk |
| MCSIO | Azure temporary disk first, otherwise Write-back cache disk |

Note:

Even if image preparation is decoupled from the provisioning scheme creation, MCS correctly determines the page file location. The default page file location is on OS disk.

Page file setting scenarios

The table describes some possible scenarios of page file setting during image preparation and provisioning scheme update:

| During | Scenario | Outcome |
|----------------------------|--|---|
| Image preparation | Source image page file is set on the temporary disk, while the VM size specified in provisioning scheme has no temporary disk | The page file is placed on the OS disk |
| Image preparation | Source image page file is set on the OS disk, while the VM size specified in provisioning scheme has temporary disk. | The page file is placed on the temporary disk |
| Image preparation | Source image page file is set on the temporary disk, while the ephemeral OS disk is enabled in provisioning scheme. | The page file is placed on the OS disk |
| Provisioning scheme update | You attempt to update the provisioning scheme, the original VM size has temporary disk, and the target VM has no temporary disk. | Rejects the change with an error message |
| Provisioning scheme update | You attempt to update the provisioning scheme, the original VM size has no temporary disk, and the target VM has temporary disk | Rejects the change with an error message |

Update page file setting

You can also specify the page file setting, including the location and size, explicitly using the PowerShell command. This overrides the value determined by MCS. You can do this by running the `New-ProvScheme` command and including the following custom properties:

- `PageFileDiskDriveLetterOverride`: Page file location disk drive letter
- `InitialPageFileSizeInMB`: Initial page file size in MB
- `MaxPageFileSizeInMB`: Maximum page file size in MB

Example of using the custom properties:

```

1 -CustomProperties '<CustomProperties xmlns=" http://schemas.citrix.com
  /2014/xd/machinecreation" xmlns:xsi=" http://www.w3.org/2001/
  XMLSchema-instance"> `
2 <Property xsi:type="StringProperty" Name="PersistOsDisk" Value="false
  "/> `
3 <Property xsi:type="StringProperty" Name="PersistVm" Value="false"/> `
4 <Property xsi:type="StringProperty" Name="
  PageFileDiskDriveLetterOverride" Value="d"/> `
5 <Property xsi:type="StringProperty" Name="InitialPageFileSizeInMB"
  Value="2048"/> `
6 <Property xsi:type="StringProperty" Name="MaxPageFileSizeInMB" Value
  ="8196"/> `
7 <Property xsi:type="StringProperty" Name="StorageAccountType" Value="
  Premium_LRS"/> `
8 <Property xsi:type="StringProperty" Name="LicenseType" Value="
  Windows_Client"/> `
9 </CustomProperties>'
10 <!--NeedCopy-->

```

Constraints:

- You can update the page file setting only when creating provisioning scheme by running the [New-ProvScheme](#) command and the page file setting cannot be changed later.
- Provide all the page file setting relative properties ([PageFileDiskDriveLetterOverride](#), [InitialPageFileSizeInMB](#), and [MaxPageFileSizeInMB](#)) in the custom properties or do not provide any of them.
- The initial page file size must be between 16 MB and 16777216 MB.
- The maximum page file size must be greater than or equal to the initial page file size and less than 16777216 MB.
- This feature is not supported in Web Studio.

Create a catalog using Azure Spot VMs

Azure Spot VMs allow you to take advantage of Azure's unused computing capacity at a significant cost savings. However, the ability to allocate an Azure Spot VM is dependent on the current capacity and pricing. Therefore, Azure might evict your running VM, fail to create the VM, or fail to power on the VM as per the [Eviction policy](#). Therefore, Azure Spot VMs are good for some non-critical applications and desktops. For more information, see [Use Azure Spot Virtual Machines](#).

Limitations

- All VM sizes aren't supported for Azure Spot VMs. For more information, see [Limitations](#).

You can run the following PowerShell command to check whether a VM size supports Spot VMs or not. If a VM size supports Spot VM, then [SupportsSpotVM](#) is **True**.

```

1 (Get-Item "XDHyp:\HostingUnits\azure-res-conn2\serviceoffering.
   folder\Standard_D2ds_v4.serviceoffering"). AdditionalData
2 <!--NeedCopy-->

```

- Currently, Azure Spot VMs do not support hibernation.

Requirement

While creating the machine profile source (VM or template spec) for Azure Spot VMs catalog, you must select Azure Spot Instance (if using VM) or set `priority` as `Spot` (if using template spec).

Steps to create a catalog using Azure Spot VMs

1. Create a machine profile source (VM or launch template).
 - For creating a VM using Azure portal, see [Deploy Azure Spot Virtual Machines using the Azure portal](#).
 - For creating a template spec, add the following properties under **resources > type: Microsoft.Compute/virtualMachines > properties** in the template spec. For example:

```

1 "priority": "Spot",
2 "evictionPolicy": "Deallocate",
3 "billingProfile": {
4
5 "maxPrice": 0.01
6 }
7
8 <!--NeedCopy-->

```

Note:

- Eviction policy can be **Deallocate** or **Delete**.
 - For non-persistent VMs, MCS always sets the eviction policy as **Delete**. If the VM is evicted, it is deleted along with any non-persistent disks (For example, OS disk). Any persistent disks (for example, Identity disk) are not deleted. However, an OS disk is persistent if the catalog type is persistent or the `PersistOsDisk` custom property is set to `True`. Similarly, a WBC disk is persistent if the `PersistWbc` custom property is set to **True**.
 - For persistent VMs, MCS always sets the eviction policy as `Deallocate`. If the VM is evicted, it is deallocated. No changes are made to the disks.
- Maximum price is the price you are willing to pay per hour. If you are using **Capacity Only**, then this is **-1**. The maximum price can only be null, -1, or a decimal greater than

zero. For more information, see [Pricing](#).

2. You can run the following PowerShell command to check if a machine profile is Azure Spot VM enabled or not. If the `SpotEnabled` parameter is **True** and `SpotEvictionPolicy` is set to **Deallocate** or **Delete**, then the machine profile is Azure Spot VM enabled. For example,

- If the machine profile source is a VM, run the following command:

```
1 (Get-Item "XDHyp:\HostingUnits\azure-res-conn2\machineprofile
   .folder\fifthcolumn.resourcegroup\kb-spot-delete.vm").
   AdditionalData
2 <!--NeedCopy-->
```

- If the machine profile source is a template spec, run the following command:

```
1 (Get-Item "XDHyp:\HostingUnits\azure-res-conn2\machineprofile
   .folder\fifthcolumn.resourcegroup\fc-aeh-templatespec.
   templatespec\14.0.0-spot-delete.templatespecversion").
   AdditionalData
2 <!--NeedCopy-->
```

3. Create a machine catalog using a machine profile with `New-ProvScheme` PowerShell command.

You can update a catalog using the `Set-ProvScheme` command. You can also update existing VMs using the PowerShell command `Set-ProvVmUpdateTimeWindow`. The machine profile is updated on the next power on.

Evictions on a running Azure Spot VM

If the computing capacity is unavailable or the price per hour is higher than the maximum price as configured, Azure evicts a running Spot VM. By default, you are not notified of an eviction. The VM simply freezes and the VM is evicted. Microsoft recommends using Scheduled Events to monitor evictions. See [Continuously monitor for eviction](#). You can also run scripts from within a VM to get a notification before the eviction. For example, Microsoft has a polling script in Python [ScheduledEvents.cs](#).

Troubleshooting

- You can see Spot VM properties in the provisioned VM's `customMachineData` using the `Get-ProvVm` command. If the priority field is set to **Spot**, then Spot is in use.
- You can check if a VM is using Spot in Azure Portal:
 1. Find the VM in the Azure Portal.
 2. Go to the **Overview** page.

3. Scroll down to the bottom and locate the **Azure Spot** section.
 - If Spot is not in use, then this field is empty.
 - If Spot is in use, the **Azure Spot** and **Azure Spot eviction policy** fields are set.
1. You can check the billing profile or maximum price per hour for the VM on the Configuration page.

Configure backup VM sizes

Public clouds can sometimes run out of capacity for a specific VM size. Also, if you use Azure Spot VMs, then the VMs are evicted at any time based on Azure's capacity needs. In such a case of insufficient capacity on Azure or a Spot VM power on failure, MCS falls back on the backup VM sizes. You can provide a list of backup VM sizes using a custom property `BackupVmConfiguration` while creating or updating an MCS machine catalog. MCS tries to fall back on the backup VM sizes in the order that is provided by you in the list.

When MCS uses a particular backup configuration for the VM, it continues to use that configuration until the next shutdown. On the next power-on, MCS tries to boot the primary VM configuration. In case of failure, MCS again tries to boot a backup VM size configuration as per the list.

This feature is supported for:

- a catalog that uses a machine profile
- persistent and non-persistent MCS machine catalogs
- Azure environments currently

Important considerations

- You can provide more than one backup VM size in the list.
- The list must be unique.
- You can add the instance type property for each of the VMs in the list. The type is either **Spot** or **Regular**. If the type is not specified, then MCS considers the VM to be **Regular**.
- You can change the backup VM size list of an existing catalog using the `Set-ProvScheme PowerShell` commands.
- You can update the existing VMs created from the provisioning scheme associated with the catalog using `Set-ProvVMUpdateTimeWindow` command.
- You can configure the backup VM size list for a selected number of existing MCS VMs using the `Set-ProvVM` command. However, to apply the updates, set an update time window for the VMs using `Set-ProvVMUpdateTimeWindow` and start the VMs within the window. If the `Set-ProvVm` command is used on a VM, the VM continues to use the backup VM size list set on

that particular VM even if the list on the provisioning scheme is later updated. You can use `Set-ProvVM` with `-RevertToProvSchemeConfiguration` to make the VM use the backup list on the provisioning scheme.

Create a catalog with backup VM sizes

1. Open a **PowerShell** window.
2. Run `asnp citrix*` to load the Citrix-specific PowerShell modules.
3. Create a Broker catalog. This catalog is populated with machines which are about to be created.
4. Create an identity pool. This becomes a container for AD accounts created for the machines that are to be created.
5. Create a provisioning scheme with the machine profile. For example:
 - If you want to provide a list of only regular VM sizes, run the following:

```

1  New-ProvScheme -ProvisioningSchemeName "azure-catalog" -
    MasterImageVM "XDHyp:\HostingUnits\azure-zones\image.
    folder\helenli.resourcegroup\helenli-master1-mcsio-
    snapshot.snapshot"
2  -CustomProperties
3  "<CustomProperties xmlns='\"http://schemas.citrix.com/2014/xd/
    machinecreation\" xmlns:xsi='\"http://www.w3.org/2001/
    XMLSchema-instance\">
4  <Property xsi:type='\"StringProperty\"' Name='\"UseManagedDisks\"
    \" Value='\"true\"' />
5  <Property xsi:type='\"StringProperty\"' Name='\"
    StorageAccountType\"' Value='\"Premium_LRS\"' />
6  <Property xsi:type='\"StringProperty\"' Name='\"LicenseType\"'
    Value='\"Windows_Server\"' />
7  <Property xsi:type='\"StringProperty\"' Name='\"PersistWBC\"'
    Value='\"true\"' /> <Property xsi:type='\"StringProperty\"'
    Name='\"BackupVmConfiguration\"' Value='\"['ServiceOffering':
    'Standard_D2as_v4', 'ServiceOffering': 'Standard_D2s_v3',
    'ServiceOffering': 'C']\"' />
8  </CustomProperties>"
9  <!--NeedCopy-->

```

- If you want to provide a list of mixed VM sizes (regular and spot VMs), run the following:

```

1  New-ProvScheme -ProvisioningSchemeName "azure-catalog" -
    MasterImageVM "XDHyp:\HostingUnits\azure-zones\image.
    folder\helenli.resourcegroup\helenli-master1-mcsio-
    snapshot.snapshot"
2  -CustomProperties
3  "<CustomProperties xmlns='\"http://schemas.citrix.com/2014/xd/
    machinecreation\" xmlns:xsi='\"http://www.w3.org/2001/
    XMLSchema-instance\">

```



```

4 <Property xsi:type="StringProperty" Name="UseManagedDisks"
  " Value="true" />
5 <Property xsi:type="StringProperty" Name="
  StorageAccountType" Value="Premium_LRS" />
6 <Property xsi:type="StringProperty" Name="LicenseType"
  Value="Windows_Server"/>
7 <Property xsi:type="StringProperty" Name="PersistWBC"
  Value="true"/> <Property xsi:type="StringProperty"
  Name="BackupVmConfiguration" Value="[{
8 'ServiceOffering': 'Standard_D2as_v4', 'Type': 'Spot' }
9 , {
10 'ServiceOffering': 'Standard_D2s_v3', 'Type': 'Regular' }
11 , {
12 'ServiceOffering': 'Standard_D2s_v3', 'Type': 'Spot' }
13 ]"/>
14 </CustomProperties>"
15 <!--NeedCopy-->

```

6. Update the BrokerCatalog with the unique Id of the provisioning scheme.
7. Create and add VMs to the catalog.

Update an existing catalog

You can update a provisioning scheme using the `Set-ProvScheme` command. For example:

```

1 Set-ProvScheme -ProvisioningSchemeName "azure-catalog"
2 -CustomProperties
3 "<CustomProperties xmlns="http://schemas.citrix.com/2014/xd/
  machinecreation"xmlns:xsi="http://www.w3.org/2001/XMLSchema-
  instance">
4 <Property xsi:type="StringProperty" Name="UseManagedDisks" Value="
  true" />
5 <Property xsi:type="StringProperty" Name="StorageAccountType" Value
  ="Premium_LRS" />
6 <Property xsi:type="StringProperty" Name="LicenseType" Value="
  Windows_Server"/>
7 <Property xsi:type="StringProperty" Name="PersistWBC" Value="true"
  "/>
8 <Property xsi:type="StringProperty" Name="BackupVmConfiguration"
  Value="[{
9 'ServiceOffering': 'Standard_D2as_v4', 'Type': 'Spot' }
10 , {
11 'ServiceOffering': 'Standard_D2s_v3', 'Type': 'Regular' }
12 , {
13 'ServiceOffering': 'Standard_D2s_v3', 'Type': 'Spot' }
14 ]"/>
15 </CustomProperties>"
16 <!--NeedCopy-->

```

Update existing VMs

You can update existing VMs in a catalog using `Set-ProvVMUpdateTimeWindow` PowerShell command. The command updates the VMs created from the provisioning scheme associated with the catalog on the next power on within the given time window. For example:

- `Set-ProvVMUpdateTimeWindow -ProvisioningSchemeName azure-catalog -StartTimeInUTC "3/12/2022 3am"-DurationInMinutes 60`
- `Set-ProvVMUpdateTimeWindow -ProvisioningSchemeName azure-catalog -StartsNow -DurationInMinutes 60`

Note:

`StartsNow` indicates the scheduled start time. `DurationInMinutes` is the schedule's time window.

You can configure the backup VM size list for a selected number of existing MCS VMs using the `Set-ProvVM` command. However, to apply the updates, set an update time window for the VMs using `Set-ProvVMUpdateTimeWindow` and start the VMs within the window. For example:

1. Run the `Set-ProvVM` command to configure the backup VM size list for a selected existing MCS VM. For example:

```

1 Set-ProvVM -VMName "Vm-001"
2 -CustomProperties
3 "<CustomProperties xmlns="http://schemas.citrix.com/2014/xd/machinecreation" xmlns:xsi="http://www.w3.org/2001/XMLSchema-instance">
4 <Property xsi:type="StringProperty" Name="UseManagedDisks"
5   Value="true" />
6 <Property xsi:type="StringProperty" Name="StorageAccountType"
7   Value="Premium_LRS" />
8 <Property xsi:type="StringProperty" Name="LicenseType" Value="
9   Windows_Server"/>
10 <Property xsi:type="StringProperty" Name="PersistWBC" Value="
11   true"/>
12 <Property xsi:type="StringProperty" Name="BackupVmConfiguration
13   " Value="[{
14   'ServiceOffering': 'Standard_D2as_v4', 'Type': 'Spot' }
15   , {
16   'ServiceOffering': 'Standard_D2s_v3', 'Type': 'Regular' }
17   , {
18   'ServiceOffering': 'Standard_D2s_v3', 'Type': 'Spot' }
19   ]"/>
20 </CustomProperties>"
21 <!--NeedCopy-->

```

2. Run the `Set-ProvVMUpdateTimeWindow` command to apply the updates. For example:

```
1 Set-ProvVMUpdateTimeWindow -ProvisioningSchemeName azure-catalog -
  StartsNow -DurationInMinutes 60
2 <!--NeedCopy-->
```

Copy tags on all resources

You can copy tags specified in a machine profile to all the resources such as, multiple NICs and disks (OS disk, Identity disk, and write-back cache disk) of a new VM or an existing VM in a machine catalog. The machine profile source can be a VM or an ARM template spec.

Note:

You must add the policy on the tags (See [Assign policy definitions for tag compliance](#)) or add the tags in a machine profile source to retain the tags on the resources.

Prerequisites

Create the machine profile source (VM or ARM template spec) to have tags on VM, disks, and NICs of that VM.

- If you want to have a VM as a machine profile input, then apply tags on the VM and all the resources in the Azure portal. See [Apply tags with Azure portal](#).
- If you want to have ARM template spec as a machine profile input, then add the following tag block under each resource.

```
1   "tags": {
2
3   "TagC": "Value3"
4   }
5   ,
6   <!--NeedCopy-->
```

Note:

You can have a maximum of one disk and at least one NIC in the template spec.

Copy tags to the resources of a VM in a new machine catalog

1. Create a non-persistent or persistent catalog with a VM or ARM template spec as a machine profile input.
2. Add a VM to the catalog and power it on. You must see the tags specified in the machine profile copied to the corresponding resources of that VM.

Note:

You get an error if there is a mismatch in the number of NICs provided in the machine profile and the number of NICs you want the VMs to use.

Modify tags on the resources of an existing VM

1. Create a machine profile with the tags on all the resources.
2. Update the existing machine catalog with the updated machine profile. For example:

```
1 Set-ProvScheme -ProvisioningSchemeName <YourCatalogName> -  
   MachineProfile <PathToYourMachineProfile>  
2 <!--NeedCopy-->
```

3. Turn off the VM on which you want to apply the updates.
4. Request scheduled update for the VM. For example:

```
1 Set-ProvVMUpdateTimeWindow -ProvisioningSchemeName <  
   YourCatalogName> -VMName machine1 -StartsNow -  
   DurationInMinutes -1  
2 <!--NeedCopy-->
```

5. Turn on the VM.
6. You must see the tags specified in the machine profile copied to the corresponding resources.

Note:

You get an error if there is a mismatch in the number of NICs provided in the machine profile and the number of NICs provided in the `Set-ProvScheme`.

Where to go next

- If this is the first catalog created, Web Studio guides you to [create a delivery group](#)
- To review the entire configuration process, see [Install and configure](#)
- To manage catalogs, see [Manage machine catalogs](#) and [Manage a Microsoft Azure catalog](#)

More information

- [Create and manage connections and resources](#)
- [Connection to Microsoft Azure Resource Manager](#)
- [Create machine catalogs](#)

Create a Microsoft System Center Virtual Machine Manager catalog

November 1, 2023

[Create machine catalogs](#) describes the wizards that create a machine catalog. The following information covers details specific to Microsoft System Center Virtual Machine Manager (VMM) virtualization environments.

Note:

Before creating a VMM catalog, you need to finish creating a connection to VMM. See [Connection to Microsoft System Center Virtual Machine Manager](#).

Create a master VM

1. Install a VDA on the master VM, and select the option to optimize the desktop to improve performance.
2. Take a snapshot of the master VM to use as a backup.
3. Create virtual desktops.

MCS on SMB 3 file shares

For machine catalogs created with MCS on SMB 3 file shares for VM storage, ensure that credentials meet the following requirements. These requirements ensure that calls from the Controller's Hypervisor Communications Library (HCL) connect successfully to SMB storage:

- VMM user credentials must include full read write access to the SMB storage.
- Storage virtual disk operations during VM life cycle events are performed through the Hyper-V server using the VMM user credentials.

When you use SMB storage, enable the Authentication Credential Security Support Provider (CredSSP) from the Controller to individual Hyper-V machines. Use this process for VMM 2012 SP1 with Hyper-V on Windows Server 2012. For more information, see CTX137465.

The HCL uses [CredSSP](#) to open a connection to the Hyper-V machine. This feature passes Kerberos-encrypted user credentials to the Hyper-V machine. The **PowerShell** commands in the session on the remote Hyper-V machine run with the credentials provided. In this case, the credentials of the VMM user, so that communication commands to storage work correctly.

The following tasks use PowerShell scripts that originate in the HCL and are then sent to the Hyper-V machine to act on the SMB 3.0 storage.

- **Consolidate master image:** A master image creates an MCS provisioning scheme (machine catalog). It clones and flattens the master VM ready for creating VMs from the new disk created (and removes dependency on the original master VM).

ConvertVirtualHardDisk on the root\virtualization\v2 namespace

Example:

```
1 $ims = Get-WmiObject -class $class -namespace "root\\virtualization\\v2"
   ";
2 $result = $ims.ConvertVirtualHardDisk($diskName, $vhdaText)
3 $result
4 <!--NeedCopy-->
```

- **Create difference disk:** Creates a difference disk from the master image generated by consolidating the master image. The difference disk is then attached to a new VM.

CreateVirtualHardDisk on the root\virtualization\v2 namespace

Example:

```
1 $ims = Get-WmiObject -class $class -namespace "root\\virtualization\\v2"
   ";
2 $result = $ims.CreateVirtualHardDisk($vhdaText);
3 $result
4 <!--NeedCopy-->
```

- **Upload identity disks:** The HCL cannot directly upload the identity disk to SMB storage. Therefore, the Hyper-V machine must upload and copy the identity disk to the storage. Because the Hyper-V machine cannot read the disk from the Controller, the HCL must first copy the identity disk through the Hyper-V machine as follows.

1. The HCL uploads the Identity to the Hyper-V machine through the administrator share.
2. The Hyper-V machine copies the disk to the SMB storage through a PowerShell script running in the PowerShell remote session. A folder is created on the Hyper-V machine and the permissions on that folder are locked for the VMM user only (through the remote PowerShell connection).
3. The HCL deletes the file from the administrator share.
4. When the HCL finishes uploading the identity disk to the Hyper-V machine, the remote PowerShell session copies the identity disks to SMB storage. It then deletes it from the Hyper-V machine.

The identity disk folder is recreated if it is deleted so that it is available for reuse.

- **Download identity disks:** As with uploads, the identity disks pass through the Hyper-V machine to the HCL. The following process creates a folder that only has VMM user permissions on the Hyper-V server if it does not exist.

1. The Hyper-V machine copies the disk from the SMB storage to the local Hyper-V storage through a PowerShell script. This script runs in the PowerShell V3 remote session.
2. HCL reads the disk from the Hyper-V machine's administrator share into memory.
3. HCL deletes the file from the administrator share.

Create a catalog with a machine profile

You can use a machine profile to create and update an MCS machine catalog in System Center Virtual Machine Manager (SCVMM) environments. You can also enable nested virtualization and vTPM.

Important considerations

- Master image can only be a snapshot and not a VM.
- You can only use VM as the machine profile source.
- You can configure vTPM from the Hyper-V console and not from the SCVMM console.
- If the master image has vTPM enabled, then you must enable the vTPM on the machine profile source.
- vTPM is only supported on Generation 2 machines.
- The following parameters overwrite the values captured in a machine profile if provided separately:
 - VMcpuCount
 - VMmemoryMB
 - Disk storage
- You can update an existing catalog using the `Set-ProvScheme` command.

Steps to create a catalog using a machine profile

1. Create a VM to be a machine profile source. For more information, see [Provision virtual machines in the VMM fabric](#). You cannot change the **Generation** once selected.
 - If you want to enable nested virtualization, select the **Enable Nested Virtualization** checkbox on the **Select Source** page.
 - If you want to enable vTPM, then after you create the VM, log in to the Hyper-V host and find your VM under the **Hyper-V Manager**. Right-click the VM, then go to **Settings**. Under **Security**, select the **Enable Trusted Platform Module** checkbox.
2. Open a **PowerShell** window.

3. Run `asnp citrix*` to load the Citrix-specific PowerShell modules.
4. Create a Broker catalog. This catalog is populated with machines which are about to be created.
5. Create an identity pool. This becomes a container for AD accounts created for the machines that are to be created.
6. Create a provisioning scheme with the machine profile. For example:

```
1 New-ProvScheme -HostingUnitName "<hostingunit name>"
2 -IdentityPoolName "ID1" -MasterImageVM "XDHyp:\HostingUnits\HU1\<
  path to the checkpoint/snapshot>"
3 -ProvisioningSchemeName "<catalogname>" -MachineProfile "XDHyp:\<
  path to the machine profile VM>"
4 <!--NeedCopy-->
```

7. Updates the Broker catalog with the unique Id of the provisioning scheme.
8. Create and add VMs to the catalog.

You can update an existing catalog using the Set-ProvScheme command. For example:

```
1 Set-ProvScheme -ProvisioningSchemeName "<catalogname>" -MachineProfile
  "XDHyp:\<path to the machine profile VM>"
2 <!--NeedCopy-->
```

Where to go next

- If this is the first catalog created, Web Studio guides you to [create a delivery group](#)
- To review the entire configuration process, see [Install and configure](#)
- To manage catalogs, see [Manage machine catalogs](#) and [Manage a Microsoft System Center Virtual Machine Manager catalog](#)

More information

- [Create and manage connections and resources](#)
- [Connection to Microsoft System Center Virtual Machine Manager](#)
- [Create machine catalogs](#)

Create a Nutanix catalog

January 26, 2024

[Create machine catalogs](#) describes the wizards that create a machine catalog. The following information covers details specific to Nutanix virtualization environments.

Note:

Before creating a Nutanix catalog, you need to finish creating a connection to Nutanix. See [Connection to Nutanix](#).

Create a machine catalog using a Nutanix snapshot

The snapshot you select is the template used to create the VMs in the catalog. Before creating the catalog, create images and snapshots in Nutanix. For more information, see the Nutanix documentation.

In the catalog creation wizard:

- The **Operating System** and **Machine Management** pages do not contain Nutanix-specific information.
- The **Container** or **Cluster and Container** page is unique to Nutanix.

If you deploy machines by using Nutanix AHV XI as the resources, you see the **Container** page. Select a container where the VMs' identity disks will be placed.

If you deploy machines by using Nutanix AHV Prism Central (PC) as the resources, you see the **Cluster and Container** page. Select which cluster to use for the deployment of VMs and then a container.

- On the **Image** page, select the image snapshot. Acropolis snapshot names must be prefixed with "XD_" to be used in Citrix Virtual Apps and Desktops. Use the Acropolis console to rename your snapshots if needed. If you rename snapshots, restart the catalog creation wizard to see a refreshed list.
- On the **Virtual Machines** page, indicate the number of virtual CPUs and the number of cores per vCPU.
- On the **Network Cards** page, select the NIC type to filter associated networks. There are two NIC types: **VLAN** and **OVERLAY**. Select one or more NICs that the master image contains and then select an associated virtual network for each NIC.
- The **Machine Identities**, **Domain Credentials**, **Scopes**, and **Summary** pages do not contain Nutanix-specific information.

Limitation

When creating an MCS catalog with Nutanix host connection (specifically, Nutanix AHV plug-in 2.7.1), the hard disk size of provisioned VMs are incorrectly displayed in Web Studio. The size displayed is

much smaller (1 GB) than the real storage size (50 GB). The hard disk size is correctly displayed on the Nutanix console.

Where to go next

- If this is the first catalog created, Web Studio guides you to [create a delivery group](#)
- To review the entire configuration process, see [Install and configure](#)
- To manage catalogs, see [Manage machine catalogs](#)

More information

- [Create and manage connections and resources](#)
- [Connection to Nutanix](#)
- [Connection to Nutanix cloud and partner solutions](#)
- [Create machine catalogs](#)

Create a VMware catalog

January 29, 2024

[Create machine catalogs](#) describes the wizards that create a machine catalog. The following information covers details specific to VMware virtualization environments.

Note:

Before creating a VMware catalog, you need to finish creating a connection to VMware. See [Connection to VMware](#).

Create a master VM

Use a master VM to provide user desktops and applications in a machine catalog. On your hypervisor:

1. Install a VDA on the master VM, selecting the option to optimize the desktop, which improves performance.
2. Take a snapshot of the master VM to use as a back-up.

Note:

You can use MCS to provision VMs in vSAN 8.0 environment.

Create a machine catalog using a machine profile

You can create an MCS machine catalog using a machine profile. The source of the machine profile input is a VMware template. The machine profile captures the hardware properties from a VMware template and applies them to the newly provisioned VMs in the catalog.

Note:

- Master image input (snapshot) and machine profile input (VMware template) must either be both vTPM enabled or both vTPM disabled. This rule applies to both [New-ProvScheme](#) and [Set-ProvScheme](#).
- If the master image is vTPM enabled, then the VMware template can only come from the same VM source as the master image.
- Encrypted storage policy only supports full clone.

The VMware template in the machine profile must exist during the catalog life cycle to allow provisioning of VMs to the catalog. Without a VMware template, you cannot provision new VMs. When a VMware template gets deleted, you must supply a new template using the [Set-ProvScheme](#) command.

- MCS captures properties of a VMware template. You can create new a VMware template referencing stored properties of VMware template using the [Get-Provscheme](#) command.
- Alternatively, if the machine catalog and provisioned VMs exist, then an MCS provisioned machine can also be used to create a new VMware template.

Based on different OS, you can create a machine catalog with different configurations:

- If windows 11 is installed on the master image, then it is a requirement to have vTPM enabled for the master image. Therefore, the VMware template, which is a source of machine profile, must have vTPM attached to it.
- If windows 10 is installed on the master image with no vTPM attached, then you can create a machine catalog with non-vTPM VMware template as source for machine profile.

There is another configuration where you can create a machine catalog using full copy disk mode with machine profile template applied with encrypted storage policy.

To create a machine catalog using PowerShell commands with machine profile as input:

1. Open a **PowerShell** window.
2. Run `asnp citrix*`.

3. Run the following commands:

- To create a machine catalog with vTPM attached VMware template as a source for machine profile input and windows11 installed master image:

```

1 $identityPool = New-AcctIdentityPool -IdentityPoolName "<string>"
2 -NamingScheme "<string>-###"
3 -NamingSchemeType Numeric
4 -Domain "<domain name>"
5 -ZoneUid "<Uid>" -Scope @()
6 <!--NeedCopy-->

```

```

1 $provScheme =New-ProvScheme -CleanOnBoot
2 -HostingUnitName "vSanRg"
3 -IdentityPoolName "<string>"
4 -InitialBatchSizeHint 1
5 -MasterImageVM "XDHyp:\HostingUnits\<hosting unit name>\<snapshot name>.snapshot"
6 -NetworkMapping @{
7 "0"="XDHyp:\HostingUnits\<hosting unit name>\<network name>.network" }
8
9 -ProvisioningSchemeName "<string>"
10 -Scope @() -VMCpuCount 4
11 -VMMemoryMB 6144
12 -MachineProfile "XDHyp:\HostingUnits\<hosting unit name>\<template name>.template" -TenancyType Shared
13 -FunctionalLevel "L7_20"
14 <!--NeedCopy-->

```

```

1 $catalog = New-BrokerCatalog
2 -AllocationType "Static"
3 -PersistUserChanges "OnLocal"
4 -Description "<string>"
5 -IsRemotePC $False
6 -MinimumFunctionalLevel 'L7_9'
7 -Name "<catalog name>"
8 -ProvisioningType 'MCS'
9 -Scope @()
10 -SessionSupport "SingleSession" -ZoneUid "<Uid>"
11 <!--NeedCopy-->

```

```

1 Set-BrokerCatalog -Name "<string>"
2 -ProvisioningSchemeId $provScheme.ProvisioningSchemeUid.Guid
3 <!--NeedCopy-->

```

- To create a machine catalog with Non-vTPM VMware template as source for machine profile and Windows10 installed master image:

```

1 $identityPool = New-AcctIdentityPool
2 -IdentityPoolName "<string>"

```

```

3 -NamingScheme "<string>-###" -NamingSchemeType Numeric
4 -Domain "<domain name>"
5 -ZoneUid "<UId>" -Scope @()
6 <!--NeedCopy-->

```

```

1 $provScheme =New-ProvScheme
2 -CleanOnBoot -HostingUnitName "<string>"
3 -IdentityPoolName "<string>"
4 -InitialBatchSizeHint 1
5 -MasterImageVM "XDHyp:\HostingUnits\<hosting unit name>\<
  snapshot name>.snapshot
6 -NetworkMapping @{
7 "0"="XDHyp:\HostingUnits\<hosting unit name>\<string>.
  network" }
8
9 -ProvisioningSchemeName "<string>" -Scope @() -VMCpuCount 4
  -VMMemoryMB 8192
10 -MachineProfile "XDHyp:\HostingUnits\<hosting unit name>\<
  template name>.template"
11 -TenancyType Shared -FunctionalLevel "L7_20"
12 <!--NeedCopy-->

```

```

1 $catalog = New-BrokerCatalog
2 -AllocationType "Static"
3 -PersistUserChanges "OnLocal"
4 -Description "<string>"
5 -IsRemotePC $False
6 -MinimumFunctionalLevel 'L7_9' -Name "<string>" -
  ProvisioningType 'MCS' -Scope @()
7 -SessionSupport "SingleSession" -ZoneUid "<UId>"
8 <!--NeedCopy-->

```

```

1 Set-BrokerCatalog -Name "<string>"
2 -ProvisioningSchemeId $provScheme.ProvisioningSchemeUid.Guid
3 <!--NeedCopy-->

```

- To create a machine catalog using Full copy disk mode with machine profile template applied with encrypted storage policy:

```

1 $identityPool = New-AcctIdentityPool
2 -IdentityPoolName "<string>"
3 -NamingScheme "<string>-###"
4 -NamingSchemeType Numeric
5 -Domain "<domain name>"
6 -ZoneUid "<UId>" -Scope @()
7 <!--NeedCopy-->

```

```

1 $provScheme =New-ProvScheme
2 -HostingUnitName "<string>"
3 -IdentityPoolName "<string>"
4 -InitialBatchSizeHint 1
5 -MasterImageVM "XDHyp:\HostingUnits\<hosting unit name>\<

```

```

        snapshot name>.snapshot"
6  -NetworkMapping @{
7  "0"="XDHyp:\HostingUnits\<<hosting unit name>\\<<string>.
    network" }
8
9  -ProvisioningSchemeName "<string>"
10 -Scope @() -VMCpuCount 4 -VMMemoryMB 8192 -MachineProfile "
    XDHyp:\HostingUnits\<<hosting unit name>\<template name>.
    template"
11 -TenancyType Shared
12 -FunctionalLevel "L7_20" -UseFullDiskCloneProvisioning
13 <!--NeedCopy-->

```

```

1  $catalog = New-BrokerCatalog
2  -AllocationType "Static"
3  -PersistUserChanges "OnLocal"
4  -Description "<string>" -IsRemotePC $False
5  -MinimumFunctionalLevel 'L7_9'
6  -Name "<string>" -ProvisioningType 'MCS' -Scope @()
7  -SessionSupport "SingleSession" -ZoneUid "<Uid>"
8  <!--NeedCopy-->

```

```

1  Set-BrokerCatalog -Name "<string>"
2  -ProvisioningSchemeId $provScheme.ProvisioningSchemeUid.Guid
3  <!--NeedCopy-->

```

To update a machine profile, use the Set-ProvScheme command. For example:

```

1  Set-ProvScheme -ProvisioningSchemeName 'name' -IdentityPoolName 'name'
    -MachineProfile 'XDHyp:\HostingUnits\<<hosting unit name>\<template
    name>.template'
2  <!--NeedCopy-->

```

Check for multiple NICs

You get various error messages during the pre-flight checks for multiple NICs when using a machine profile and the `NetworkMapping` parameter in the `New-ProvScheme` and `Set-ProvScheme` commands.

The pre-flight checklist for multiple NICs is as follows:

- Only NIC count from the machine profile template is used and validated. The network to which these NICs point towards is not used or validated against the hosting unit networks.
- If the NIC count in the machine profile template is greater than the number of networks in the hosting unit, you get an error message.
- If the NIC count in the machine profile template is zero, you get an error message.
When the NIC count in the machine profile template is one, then:

- If no network mapping is specified in the [New-ProvScheme](#) or [Set-ProvScheme](#) command, and the hosting unit network is one, then the hosting unit network is used.
- If network mapping is specified, then the specified network mapping is used if it is valid.
- When the NIC count in the machine profile template is greater than 1, or the hosting unit network count is greater than 1, then:
 - Valid network mapping is required in the command, and it should provide mapping for each NIC (that is, [NetworkMapping](#) count should be same as the machine profile NIC count).
 - Multiple NICs cannot be mapped to the same network in the hosting unit.
 - [NetworkMapping](#) count and machine profile NIC count must be less than or equal to the hosting unit network count.
 - [NetworkMapping](#) must be provided for each id from 0 to n-1, where n is the number of network adapters in the machine profile template.

Troubleshooting

If the catalog fails to create, see [CTX294978](#).

Where to go next

- If this is the first catalog created, Web Studio guides you to [create a delivery group](#)
- To review the entire configuration process, see [Install and configure](#)
- To manage catalogs, see [Manage machine catalogs](#) and [Manage a VMware catalog](#)

More information

- [Create and manage connections and resources](#)
- [Connection to VMware](#)
- [Create machine catalogs](#)

Create catalogs of different join types

June 16, 2023

Using MCS, you can provision machines as on-premises AD joined or hybrid Azure AD joined.

For information about how to configure machine identities in the Web Studio, see [Create machine catalogs](#).

For specific information on how to create machine identities joined catalogs, see the following:

- [Create Hybrid Azure Active Directory joined catalogs](#)

Create Hybrid Azure Active Directory joined catalogs

November 1, 2023

This article describes how to create Hybrid Azure Active Directory (AD) joined catalogs.

You can create Azure AD joined catalogs by using the Web Studio or PowerShell.

For information on requirements, limitations, and considerations, see [Hybrid Azure Active Directory joined](#).

Use the Web Studio

The following information is a supplement to the guidance in [Create machine catalogs](#). To create hybrid Azure AD joined catalogs, follow the general guidance in that article, minding the details specific to hybrid Azure AD joined catalogs.

In the catalog creation wizard:

- On the **Machine Identities** page, select **Hybrid Azure Active Directory joined**. The created machines are owned by an organization and are signed into with an Active Directory Domain Services account that belongs to that organization. They exist in the cloud and on-premises.

Note:

If you select **Hybrid Azure Active Directory joined** as the identity type, each machine in the catalog must have a corresponding AD computer account.

Use PowerShell

The following are PowerShell steps equivalent to operations in Web Studio. For information on how to create a catalog using the Remote PowerShell SDK, see <https://developer-docs.citrix.com/projects/citrix-virtual-apps-desktops-sdk/en/latest/creating-a-catalog/>.

The difference between on-premises AD joined catalogs and hybrid Azure AD joined ones lies in the creation of the identity pool and the machine accounts.

To create an identity pool along with the accounts for hybrid Azure AD joined catalogs:

```
1 New-AcctIdentityPool -AllowUnicode -IdentityType "HybridAzureAD" -
   Domain "corp.local" -IdentityPoolName "HybridAADJoinedCatalog" -
   NamingScheme "HybridAAD-VM-##" -NamingSchemeType "Numeric" -OU "CN=
   AADComputers,DC=corp,DC=local" -Scope @() -ZoneUid "81291221-d2f2-49
   d2-ab12-bae5bbd0df05"
2 New-AcctADAccount -IdentityPoolName "HybridAADJoinedCatalog" -Count 10
   -ADUserName "corp\admin1" -ADPassword $password
3 Set-AcctAdAccountUserCert -IdentityPoolName "HybridAADJoinedCatalog" -
   All -ADUserName "corp\admin1" -ADPassword $password
4 <!--NeedCopy-->
```

Note:

`$password` is the matching password for an AD user account with Write Permissions.

All other commands used to create hybrid Azure AD joined catalogs are the same as for traditional on-premises AD joined catalogs.

View the status of the hybrid Azure AD join process

In the Web Studio, the status of the hybrid Azure AD join process is visible when hybrid Azure AD joined machines in a delivery group are in a powered-on state. To view the status, use [Search](#) to identify those machines and then for each check **Machine Identity** on the **Details** tab in the lower pane. The following information can appear in **Machine Identity**:

- Hybrid Azure AD joined
- Not yet joined to Azure AD

Note:

- You might experience delayed hybrid Azure AD join when the machine initially powers on. This is caused by the default machine identity sync interval (30 minutes of Azure AD Connect). The machine is in hybrid Azure AD joined state only after the machine identities are synced to Azure AD through Azure AD Connect.
- If machines fail to be in hybrid Azure AD joined state, they are not registered with the Delivery Controller. Their registration status appears as **Initialization**.

Also, using the Web Studio, you can learn why machines are unavailable. To do that, click a machine on the **Search** node, check **Registration** on the **Details** tab in the lower pane, and then read the tooltip for additional information.

Troubleshoot

If machines fail to be hybrid Azure AD joined, do the following:

- Check if the machine account has been synced to Azure AD through the Microsoft Azure AD portal. If synced, **Not yet joined to Azure AD** appears, indicating pending registration status.

To sync machine accounts to Azure AD, make sure:

- The machine account is in the OU that is configured to be synced with Azure AD. Machine accounts without the **userCertificate** attribute are not synced to Azure AD even they are in the OU that is configured to be synced.
 - The attribute **userCertificate** populates in the machine account. Use Active Directory Explorer to view the attribute.
 - Azure AD Connect must have been synced at least once after the machine account is created. If not, manually run the `Start-ADSyncSyncCycle -PolicyType Delta` command in the PowerShell console of the Azure AD Connect machine to trigger an immediate sync.
- Check if the Citrix managed device key pair for hybrid Azure AD join is correctly pushed to the machine by querying the value of **DeviceKeyPairRestored** under **HKEY_LOCAL_MACHINE\SYSTEM\CurrentCo**

Verify that the value is 1. If not, possible reasons are:

- **IdentityType** of the identity pool associated with the provisioning scheme is not set to **HybridAzureAD**. You can verify this by running `Get-AcctIdentityPool`.
 - The machine is not provisioned using the same provisioning scheme of the machine catalog.
 - The machine is not joined to the local domain. Local domain joined is a prerequisite of the hybrid Azure AD join.
- Check diagnostic messages by running the `dsregcmd /status /debug` command on the MCS-provisioned machine.
 - If hybrid Azure AD join is successful, **AzureAdJoined** and **DomainJoined** are **YES** in the output of the command line.
 - If not, refer to the Microsoft documentation to troubleshoot the issues: <https://docs.microsoft.com/en-us/azure/active-directory/devices/troubleshoot-hybrid-join-windows-current>.
 - If you get the error message **Server Message: The user certificate is not found on the device with id: xxxxxxxx-xxxx-xxxx-xxxx-xxxxxxxxxxxx**, then run the following PowerShell command to repair the user certificate:

```
1 Repair-AcctIdentity -IdentityAccountName TEST\VM1 -Target
   UserCertificate
2 <!--NeedCopy-->
```

For more information about the user certificate issue, see [CTX566696](#).

Manage machine catalogs

March 18, 2024

Note:

You can manage your Citrix Virtual Apps and Desktops deployment using two management consoles: Web Studio (web-based) and Citrix Studio (Windows-based).

This article covers only for Web Studio.

For information about Citrix Studio, see the equivalent article in Citrix Virtual Apps and Desktops 7 2212 or earlier.

Introduction

You can add or remove machines from a machine catalog, rename, change the description, or manage a catalog's Active Directory computer accounts.

Maintaining catalogs can also include making sure that each machine has the latest OS updates. Including antivirus updates, operating system upgrades, or configuration changes.

- Catalogs containing pooled random machines created using Machine Creation Services (MCS) maintain machines by updating the master image used in the catalog and then updating the machines. This method enables you to efficiently update large numbers of user machines.
- For catalogs containing static, permanently assigned machines, and for Remote PC Access Machine catalogs, you manage updates to users' machines outside of Web Studio. Perform this task either individually or collectively using third-party software distribution tools.

For information about creating and managing connections to host hypervisors, see [Connections and resources](#).

Note:

MCS does not support Windows 10 IoT Core and Windows 10 IoT Enterprise. Refer to the [Microsoft site](#) for more information.

About persistent instances

When updating an MCS catalog created using persistent, or dedicated instances, any new machines created for the catalog use the updated image. Pre-existing instances continue to use the original instance. The process of updating an image is done the same way for any other type of catalog. Consider the following:

- With persistent disk catalogs, the pre-existing machines are not updated to the new image, but any new machines added to the catalog use the new image.
- For non-persistent disk catalogs, the machine image is updated the next time the machine is reset.
- With persistent machine catalogs, updating the image also updates the catalog instances that use it.
- For catalogs that do not persist, if you want different images for different machines, the images must reside in separate catalogs.

Manage machine catalogs

You can manage a machine catalog in two ways:

- Using Web Studio
- Using PowerShell

Use Web Studio

This section details how you can manage catalogs using Web Studio:

- [Add machines to a catalog](#)
- [Delete machines from a catalog](#)
- [Edit a catalog](#)
- [Rename a catalog](#)
- [Move a catalog to a different zone](#)
- [Delete a catalog](#)
- [Manage Active Directory computer accounts in a catalog](#)
- [Update a catalog](#)
- [Change the functional level or undo the change](#)
- [Clone a catalog](#)
- [Organize catalogs using folders](#)

Add machines to a catalog

Before you start:

- Make sure that the virtualization host has sufficient processors, memory, and storage to accommodate the additional machines.
- Make sure that you have enough unused Active Directory computer accounts. If you are using existing accounts, the number of machines you can add is limited by the number of accounts available.
- If you use Web Studio to create Active Directory computer accounts for the additional machines, you must have appropriate domain administrator permission.

To add machines to a catalog:

1. Sign in to Web Studio.
2. Select **Machine Catalogs** in the left pane.
3. Select a machine catalog and then select **Add machines** in the action bar.
4. Select the number of virtual machines to add.
5. If there are insufficient existing Active Directory accounts for the number of VMs you are adding, select the domain and location where the accounts are created. Specify an account naming scheme, using hash marks to indicate where sequential numbers or letters appear. Do not use a forward slash (/) in an OU name. A name cannot begin with a number. For example, a naming scheme of PC-Sales-## (with 0-9 selected) results in computer accounts named PC-Sales-01, PC-Sales-02, PC-Sales-03, and so on.
6. If you use existing Active Directory accounts, either browse to the accounts or click **Import** and specify a .csv file containing account names. Make sure that there are enough accounts for all the machines you're adding. Web Studio manages these accounts. Either allow Web Studio to reset the passwords for all the accounts, or specify the account password, which must be the same for all accounts.

The machines are created as a background process, and can take much time when creating many machines. Machine creation continues even if you close Web Studio.

Delete machines from a catalog

After you delete a machine from a machine catalog, users can no longer access it, so before deleting a machine, ensure that:

- User data is backed up or no longer required.
- All users are logged off. Turning on maintenance mode stops new connections from being made to a machine.
- Machines are powered off.

To delete machines from a catalog:

1. Sign in to Web Studio.
2. Select **Machine Catalogs** in the left pane.
3. Select a catalog and then select **View Machines** in the action bar.
4. Select one or more machines and then select **Delete** in the action bar.

Choose whether to delete the machines being removed. If you choose to delete the machines, indicate if the Active Directory accounts for those machines are kept, disabled, or deleted.

Edit a catalog

1. On the **Description** page, change the catalog description.
2. Select **Machine Catalogs** in the left pane.
3. Select a catalog and then select **Edit Machine Catalog** in the action bar.
4. On the **Scopes** page, change the scopes.
5. You might see other pages depending on the catalog type.

For catalogs created using an Azure Resource Manager image, the following pages are visible. Keep in mind that changes you make apply only to machines you add to the catalog later. Existing machines remain unchanged.

- On the **Virtual Machines** page, change the machine size and availability zones where you want to create machines.

Note:

- Only the machine sizes that the catalog supports are shown.
- If necessary, select **Show only machine sizes used in other machine catalogs** to filter the machine size list.

- On the **Machine Profile** page, choose whether to use or change a machine profile.
- (Visible only when the catalog is configured with a dedicated group host) On the **Dedicated host group** page, choose whether to change a host group.
- On the **Storage and License Types** page, choose whether to change the storage type, license type, and Azure Computer Gallery settings (available only when **Place prepared image in Azure Gallery** is in use).

Note:

If the newly selected setting doesn't support the current machine size, a warning dialog box appears, informing you that changing the setting resets the machine size setting. If

you choose to continue, a red dot appears next to the **Virtual Machines** menu, prompting you to select a new machine size.

- On the **License Type** page, choose whether to change the Windows license or Linux license setting.

For Remote PC Access catalogs, the following pages are visible:

- On the **Power Management** page, change the power management settings and select a power management connection.
- On the **Organizational Units** page, add or remove Active Directory OUs.

6. Click **Apply** to apply the changes you made and click **Save** to exit.

Rename a catalog

1. Sign in to Web Studio.
2. Select **Machine Catalogs** in the left pane.
3. Select a catalog and then select **Rename Machine Catalog** in the action bar.
4. Enter the new name.

Move a catalog to a different zone

If your deployment has more than one zone, you can move a catalog from one zone to another.

Moving a catalog to a different zone, other than the hypervisor containing the VMs in that catalog, affects performance.

1. Sign in to Web Studio.
2. Select **Machine Catalogs** in the left pane.
3. Select a catalog and then select **Move** in the action bar.
4. Select the zone where you want to move the catalog.

Delete a catalog

Before deleting a catalog, ensure that:

- All users are logged off and you don't run any disconnected sessions.
- Maintenance mode is turned on for all machines in the catalog so that new connections cannot be made.
- All machines in the catalog are powered off.
- The catalog is not associated a delivery group. In other words, the delivery group does not contain machines from the catalog.

To delete a catalog:

1. Sign in to Web Studio.
2. Select **Machine Catalogs** in the left pane.
3. Select a catalog and then select **Delete Machine Catalog** in the action bar.
4. Indicate whether the machines in the catalog are deleted. If you choose to delete the machines, indicate whether the Active Directory computer accounts for those machines are retained, disabled, or deleted.

Manage Active Directory computer accounts in a catalog

To manage Active Directory accounts in a machine catalog, you can:

- Free unused machine accounts by removing Active Directory computer accounts from single-session OS and multi-session OS catalogs. Those accounts can then be used for other machines.
- Add accounts so that when more machines are added to the catalog, the computer accounts are already in place. Do not use a forward slash (/) in an OU name.

To manage Active Directory accounts:

1. Sign in to Web Studio.
2. Select **Machine Catalogs** in the left pane.
3. Select a catalog and then select **Manage AD accounts** in the action bar.
4. Choose whether to add or delete computer accounts. If you add accounts, specify what to do with the account passwords: either reset them all or enter a password that applies to all accounts.

You might reset passwords if you do not know the current account passwords; you must have permission to perform a password reset. When entering a password, the password is changed on the accounts as they are imported. When deleting an account, choose whether the account in Active Directory is kept, disabled, or deleted.

Indicate if Active Directory accounts are retained, disabled, or deleted when you remove machines from a catalog or delete a catalog.

Update a catalog

We recommend that you save copies or snapshots of master images before updating the machines in the catalog. The database keeps a historical record of the master images used with each machine catalog. Roll back, or revert, machines in a catalog to use the previous version of the master image.

Perform this task if users encounter problems with updates you deployed to their desktops. This minimizes user downtime. Do not delete, move, or rename master images. You cannot revert a catalog to use them.

After a machine is updated, it restarts automatically.

Update or create a master image

Before you update the machine catalog, either update an existing master image or create one on your host hypervisor.

1. On your hypervisor, take a snapshot of the current VM and give the snapshot a meaningful name. This snapshot can be used to revert (roll back) machines in the catalog, if needed.
2. If necessary, power on the master image, and log on.
3. Install updates or make any required changes to the master image.
4. Power off the VM.
5. Take a snapshot of the VM. Give it a meaningful name that is recognized when the catalog is updated in Web Studio. Although Web Studio can create a snapshot, Citrix recommends that you create it using the hypervisor management console. Then select that snapshot in Web Studio. This process enables you to provide a meaningful name and description rather than an automatically generated name. For GPU master images, you can change the master image only through the XenServer console.

Change the master image

To prepare and roll out the update to all machines in a catalog:

1. Sign in to Web Studio.
2. Select **Machine Catalogs** in the left pane.
3. Select a catalog and then select **Change Master Image** in the action bar.
4. On the **Image** page, select the host and the image you want to roll out.

Tip:

For an MCS-created catalog, you can annotate its image by adding a note for the image. A note can contain up to 500 characters. Each time you change the master image, a note-related entry is created whether you add a note. If you update a catalog without adding a note, the entry appears as null (-). To view note history for the image, select the catalog, click **Template Properties** in the low pane, and then click **View note history**.

5. On the **Rollout Strategy** page, choose when the machines in the machine catalog are updated with the new master image: on the next shutdown or immediately.

Note:

The **Rollout Strategy** page is not available for persistent VMs because rollout is only applicable to non-persistent VMs.

6. Verify the information on the **Summary** page and then click **Finish**. Each machine restarts automatically after it is updated.

To track the update progress, locate the catalog in **Machine Catalogs** to view the inline progress bar and the step-by-step progress graph.

When updating a catalog using PowerShell SDK directly, rather than Web Studio, specify a hypervisor template (**VM Templates**). Use this as an alternative to an image or a snapshot of an image.

Rollout strategy:

Updating images on the next shutdown will immediately affect any machines not currently in use, that is, machines that do not have an active user session. A system that is in use receives the update when the current active session ends. Consider the following:

- New sessions cannot be launched until the update has completed on applicable machines.
- For single-session OS machines, machines are immediately updated when the machine is not in use, or when users are not logged in.
- For a multi-session OS with child machines, reboots do not occur automatically. They must be manually shut down and restarted.

Tip:

Limit the number of machines being rebooted by using the advanced settings for a host connection. Use these settings to modify the actions taken for a given catalog; advanced settings vary depending on the hypervisor.

If you want to enable one-time restart schedule using PowerShell, see [Enable one-time restart schedule](#).

Roll back the master image

After you roll out an updated or new master image, you can roll it back. This process might be necessary if issues occur with the newly updated machines. When you roll back, machines in the catalog are rolled back to the last working image. Any new features that require the newer image are no longer available. As with the rollout, rolling back a machine includes a restart.

1. Sign in to Web Studio.
2. Select **Machine Catalogs** in the left pane.

3. Select the catalog and then select **Roll Back Master Image** in the action bar.
4. Specify when to apply the earlier master image to machines, as described in the preceding section for the rollout operation.

The rollback is applied only to machines that need to be reverted. Machines that are not updated with the new or updated master image do not receive notification messages and are not forced to log off.

To track the rollback progress, locate the catalog in **Machine Catalogs** to view the inline progress bar and the step-by-step progress graph.

Change the functional level or undo the change

Change the functional level for the machine catalog after you upgrade the VDAs on the machines to a newer version. Citrix recommends upgrading all VDAs to the latest version to enable access to all the newest features.

Before changing the functional level for a machine catalog:

- Start the upgraded machines so that they register with the Controller. This process lets Web Studio determine that the machines in the catalog need upgrading.

To change the functional level for a catalog:

1. Sign in to Web Studio.
2. Select **Machine Catalogs** in the left pane.
3. Select the catalog. The **Details** tab in the lower pane displays version information.
4. Select **Change Functional Level**. If Web Studio detects that the catalog needs upgrading, it displays a message. Follow the prompts. If one or more machines cannot be upgraded, a message explains why. To ensure that all machines function properly, Citrix recommends you resolve machine issues before clicking **Change** to proceed.

After the catalog change completes, you can revert the machines to their previous VDA versions by selecting the catalog and then selecting **Undo Functional Level Change** in the action bar.

Clone a catalog

Before cloning a catalog, be aware of the following considerations:

- You cannot change settings associated with [operating system](#) and [machine management](#). The cloned catalog inherits those settings from the original.
- Cloning a catalog can take some time to complete. If necessary, select **Hide progress** to run the cloning in the background.

- The cloned catalog inherits the name of the original and has a suffix **Copy**. You can change the name. See [Rename a catalog](#).
 - After cloning completes, be sure to assign the cloned catalog to a delivery group.
1. Sign in to Web Studio, and then select **Machine Catalogs** in the left pane.
 2. Select a catalog and then select **Clone** in the action bar.
 3. In the **Clone Selected Machine Catalog** window, view the settings for the cloned catalog and configure settings as applicable. Select **Next** to proceed to the next page.
 4. On the **Summary** page, view a summary of the settings and select **Finish** to start cloning.
 5. If necessary, select **Hide progress** to run the cloning in the background.

Organize catalogs using folders

You can create folders to organize catalogs for easy access. For example, you can organize catalogs by image type or by organization structure.

Create a catalog folder

Before you start, first plan how to organize your catalogs. Consider the following:

- You can nest folders up to five levels deep (excluding the default root folder).
- A catalog folder can contain catalogs and subfolders.
- All nodes in Web Studio (such as the **Machine Catalogs** and the **Applications** nodes) share a folder tree in the backend. To avoid name conflicts with other nodes when renaming or moving folders, we recommend you give different names to first-level folders in different nodes.

To create a catalog folder, follow these steps:

1. Select **Machine Catalogs** in the left pane.
2. In the folder hierarchy, select a folder and then select **Create Folder** in the **Action** bar.
3. Enter a name for the new folder, and then click **Done**.

Tip:

If you create a folder in an unintended location, you can drag it to the correct location.

Move a catalog

You can move a catalog between folders. Detailed steps are as follows:

1. Select **Machine Catalogs** in the left pane.

2. View catalogs by folder. You can also turn on **View all** above the folder hierarchy to view all catalogs at a time.
3. Right-click a catalog and then select **Move Machine Catalog**.
4. Select the folder to which you want to move the catalog, and then click **Done**.

Tip:

You can drag a catalog to a folder.

Manage catalog folders

You can delete, rename, and move catalog folders.

You can delete a folder only if it and its subfolders don't contain catalogs.

To manage a folder, follow the below steps:

1. Select **Machine Catalogs** in the left pane.
2. In the folder hierarchy, select a folder, and then select an action in the **Action** bar as needed:
 - To rename the folder, select **Rename Folder**.
 - To delete the folder, select **Delete Folder**.
 - To move the folder, select **Move Folder**.
3. Follow onscreen instructions to complete the remaining steps.

Use PowerShell

This section details how you can manage catalogs using PowerShell:

- [Retrieve warnings and errors associated with a catalog](#)
- [Enable one-time restart schedule](#)
- [Add descriptions to an image](#)
- [Reset OS disk](#)
- [Change the network setting for an existing provisioning scheme](#)
- [Manage versions of a machine catalog](#)
- [Convert a non-machine profile-based machine catalog to machine profile-based machine catalog](#)
- [Repair the identity information of active computer accounts](#)
- [Change cache configuration on an existing machine catalog](#)
- [VDA update support via local file share access](#)

Retrieve warnings and errors associated with a catalog

You can get historical errors and warnings to understand issues with your MCS machine catalog and fix those issues.

Using PowerShell commands, you can:

- Get a list of errors or warnings
- Change the warning state from **New** to **Acknowledged**
- Delete the errors or warnings

To run the PowerShell commands:

1. Open a PowerShell window.
2. Run `asnp citrix*` to load the Citrix-specific PowerShell modules.

To get a list of errors and warnings:

Run `Get-ProvOperationEvent` command.

- With no parameters: Gets all errors and warnings
- With `LinkedObjectType` and `LinkedObjectId` parameter: Gets all errors and warnings associated with a specific provisioning scheme
- With `EventId` parameter: Gets a specific error or warning that matches this event ID
- With `Filter` parameter: Gets errors or warnings by customized filter

To change the state of errors or warnings from **New** to **Acknowledged**:

Run `Confirm-ProvOperationEvent` command.

- With `EventId` parameter: Sets the state of a specific error or warning that matches this event ID. You can get the `EventId` of a specific error or warning as an output from `Get-ProvOperationEvent` command
- With `LinkedObjectType` and `LinkedObjectId` parameters: Sets the state of all the errors and warnings associated with a specific provisioning scheme
- With `All` parameter: Sets the state of all errors and warnings as **Acknowledged**

To delete the errors or warnings:

Run `Remove-ProvOperationEvent` command.

- With `EventId` parameter: Removes a specific error or warning that matches this event ID. You can get the `EventId` of a specific error or warning as an output from `Get-ProvOperationEvent` command
- With `LinkedObjectType` and `LinkedObjectId` parameters: Removes all errors and warnings associated with a specific provisioning scheme
- With `All` parameter: Removes all errors and warnings

For more information, see [Citrix PowerShell SDK](#).

Enable one-time restart schedule

If you want to enable one-time restart schedule using PowerShell, use the following `BrokerCatalogRebootSchedule` PowerShell commands to create, modify, and delete a restart schedule:

- `Get-BrokerCatalogRebootSchedule`
- `New-BrokerCatalogRebootSchedule`
- `Set-BrokerCatalogRebootSchedule`
- `Remove-BrokerCatalogRebootSchedule`
- `Rename-BrokerCatalogRebootSchedule`

For example,

- To create a restart schedule of the VMs in the catalog named **BankTellers** to begin on Feb 3, 2022, between 2 AM and 4 AM.

```
1 C:\PS> New-BrokerCatalogRebootSchedule -Name BankTellers -
    CatalogName BankTellers -StartDate "2022-02-03" -StartTime "
    02:00" -Enabled $true -RebootDuration 120
2 <!--NeedCopy-->
```

- To create a restart schedule of the VMs in the catalog having UID 17 to begin on Feb 3, 2022, between 1 AM and 5 AM. Ten minutes before the restart, each VM is set to display a message box with the title, **WARNING: Reboot pending**, and the message, **Save your work**, in every user session.

```
1 C:\PS> New-BrokerCatalogRebootSchedule -Name 'Update reboot' -
    CatalogUid 17 -StartDate "2022-02-03" -StartTime "01:00" -
    Enabled $true -RebootDuration 240 -WarningTitle "WARNING:
    Reboot pending" -WarningMessage "Save your work" -
    WarningDuration 10
2 <!--NeedCopy-->
```

- To rename the catalog restart schedule named **Old Name** to **New Name**.

```
1 C:\PS> Rename-BrokerCatalogRebootSchedule -Name "Old Name" -
    NewName "New Name"
2 <!--NeedCopy-->
```

- To display all catalog restart schedules with UID 1, and then rename the catalog reboot schedule with the UID 1 to **New Name**.

```
1 C:\PS> Get-BrokerCatalogRebootSchedule -Uid 1 | Rename-
    BrokerCatalogRebootSchedule -NewName "New Name" -PassThru
2 <!--NeedCopy-->
```

- To set the catalog restart schedule named **Accounting** to display a message with the title, **WARNING: Reboot pending, and the message, Save your work**, ten minutes before the restart of each VM. The message appears in every user session on that VM.

““

```
C:\PS> Set-BrokerCatalogRebootSchedule -Name Accounting -WarningMessage "Save your work" -WarningDuration 10 -WarningTitle "WARNING: Reboot pending"
```

- To display all restart schedules that are disabled, and then enable all disabled restart schedules.

```
1 C:\PS> Get-BrokerCatalogRebootSchedule -Enabled $false | Set-BrokerCatalogRebootSchedule -Enabled $true
```

- To set the catalog restart schedule with UID 17 to display the message **Rebooting in %m% minutes** fifteen, ten, and five minutes before the restart of each VM.

```
1 C:\PS> Set-BrokerCatalogRebootSchedule 17 -WarningMessage "Rebooting in %m% minutes." -WarningDuration 15 -WarningRepeatInterval 5
```

- To configure the time zone for the catalog named **MyCatalog**.

```
1 C:\PS> Set-BrokerCatalog -Name "MyCatalog" -TimeZone <TimeZone>
```

Add descriptions to an image

You can add informative descriptions about changes related to image updates for machine catalogs. Use this feature to add a description when creating a catalog, or when you update an existing master image for a catalog. You can also display information for each master image in the catalog. Use the following commands to add or view image descriptions:

- To add a note while creating a machine catalog with a master image, use the parameter **MasterImageNote** in the **NewProvScheme** command. For example:

```
1 C:\PS>New-ProvScheme -ProvisioningSchemeName <name> -
    HostingUnitName <name> -IdentityPoolName <name> -MasterImageVM
2 XDHyp:\HostingUnits\<hosting unit name>\<vm name>.vm\Base.
    snapshot -MasterImageNote "Note"
```

- To update the master image associated with a machine catalog, use the parameter **MasterImageNote** in the **Publish-ProvMasterVMImage** command. For example:

```
1 C:\PS>Publish-ProvMasterVMImage -ProvisioningSchemeName <name> -
    MasterImageVM XDHyp:\HostingUnits\<hosting unit name>\<vm name>
    .vm\base.snapshot -MasterImageNote "Note"
```

- To display the information for each image, use the **Get-ProvSchemeMasterVMImageHistory** command. For example:

```
1 C:\PS>Get-ProvSchemeMasterVMImageHistory -ProvisioningSchemeName  
MyScheme -Showall
```

To track the rollback progress, locate the catalog in **Machine Catalogs** to view the inline progress bar and the step-by-step progress graph.

You cannot roll back in certain scenarios, including the following. (The **Roll Back Master Image** option is not visible).

- You do not have permission to roll back.
- The catalog was not created using MCS.
- The catalog was created using an image of the OS disk.
- The snapshot used to create the catalog has become corrupted.
- User changes to the machines in the catalog do not persist.
- Machines in the catalog are running.

Reset OS disk

Use the PowerShell command `Reset-ProvVMDisk` to reset the OS disk of a persistent VM in an MCS created machine catalog. Currently, this feature is applicable to AWS, Azure, XenServer, Google Cloud, SCVMM, and VMware virtualization environments.

To successfully run the PowerShell command, make sure that:

- The target VMs are in a persistent MCS catalog.
- The MCS machine catalog is functioning properly.
- This implies that the provisioning scheme and host exist, and the provisioning scheme has correct entries.
- Hypervisor is not in maintenance mode.
- Target VMs are powered-off and in maintenance mode.

Perform the following steps to reset the OS disk:

1. Open a PowerShell window.
2. Run **asnp citrix*** to load the Citrix-specific PowerShell modules.
3. Run the PowerShell command `Reset-ProvVMDisk` in any one of the following ways:

- Specify the list of VMs as a comma-separated list, and perform the reset on each VM:

```
1 Reset-ProvVMDisk -ProvisioningSchemeName "xxx" -VMName ("abc"  
,"def") -OS
```

- Specify the list of VMs as an output from `Get-ProvVM` command, and perform the reset on each VM:

```
1 \((Get-ProvVM -ProvisioningSchemeName \"xxx\") | Reset-
  ProvVMDisk \"abc\" -OS
```

- Specify a single VM by name:

```
1 Reset-ProvVMDisk -ProvisioningSchemeName \"xxx\" -VMName \"abc\"
  -OS
```

- Create separate reset tasks for each of the VMs returned by the `Get-ProvVM` command. This is less efficient because each task will perform the same redundant checks, such as hypervisor capability check, connection check for each VM.

```
1 Get-ProvVM -ProvisioningSchemeName \"xxx\" | Reset-ProvVMDisk
  -ProvisioningSchemeName \"xxx\" -OS
```

4. A confirmation prompt appears that lists the VMs to be reset along with a warning message that it is an unrecoverable operation. If you do not provide an answer and press **Enter**, no further action takes place.

Note:

Do not take VMs out of the maintenance mode or power them on until the completion of the reset process.

You can run the PowerShell command `-WhatIf` to print the action it would take and exit without performing the action.

You can also bypass the confirmation prompt using one of the following methods:

- Provide the `-Force` parameter:

```
1 Reset-ProvVMDisk -ProvisioningSchemeName \"xxx\" -VMName \"abc\"
  -OS -Force
```

- Provide the `-Confirm:$false` parameter:

```
1 Reset-ProvVMDisk -ProvisioningSchemeName \"xxx\" -VMName \"abc\"
  -OS -Confirm:$false
```

- Before running the `Reset-ProvVMDisk`, change `$ConfirmPreference` to **None**:

```
1 PS C:\Windows\system32> $ConfirmPreference='None'
2 PS C:\Windows\system32> $ConfirmPreference
3 None
4 PS C:\Windows\system32> Reset-ProvVMDisk -
  ProvisioningSchemeName \"xxx\" -VMName \"abc\" -OS
```

5. Run `Get-ProvTask` to get the status of the tasks returned by `Reset-ProvVMDisk` command.

Change the network setting for an existing provisioning scheme

You can change the network setting for an existing provisioning scheme so that the new VMs are created on the new subnetwork. Use the parameter `-NetworkMapping` in the `Set-ProvScheme` command to change the network setting.

Note:

This feature is supported on Citrix Virtual Apps and Desktops 2203 LTSR CU3 and later versions.

To change the network setting for an existing provisioning scheme, do the following:

1. In the PowerShell window, run the command `asnp citrix*` to load the PowerShell modules.
2. Run `(Get-ProvScheme -ProvisioningSchemeName "name").NetworkMaps` to get to the network path that you want to change.
3. Assign a variable to the new network setting. For example:

```
1 $NewNetworkMap = @{  
2   "0" = "XDHYP:\HostingUnits\MyNetworks\Network 0.network" }
```

4. Run `Set-ProvScheme -ProvisioningSchemeName "name"-NetworkMapping $NewNetworkMap`.
5. Run `(Get-ProvScheme -ProvisioningSchemeName "name").NetworkMaps` to verify the new network setting for the existing provisioning scheme.

Manage versions of a machine catalog

When an MCS machine catalog is updated with the `Set-ProvScheme` command, the current configuration is saved as a version. You can then manage the various versions of the machine catalog using PowerShell commands. You can:

- See the list of versions of a machine catalog
- Use any previous version to update the machine catalog
- Manually delete a version if it is not used by a VM of that machine catalog
- Change the maximum number of versions to be retained by the machine catalog (default is 99)

A version includes the following information of a machine catalog:

- VMcpuCount
- VMMemoryMB
- CustomProperties
- ServiceOffering
- MachineProfile

- NetworkMapping
- SecurityGroup

Run the following commands (provided as examples) to manage the various versions of a machine catalog.

- To see the configuration details of the various versions of a machine catalog:

```
1 Get-ProvSchemeVersion -ProvisioningSchemeName AzureCatalog
```

- To see the configuration details of a particular version of a machine catalog:

```
1 Get-ProvSchemeVersion -ProvisioningSchemeName AzureCatalog -  
Version 2
```

- To see the total number of versions associated with a machine catalog:

```
“(Get-ProvSchemeVersion -ProvisioningSchemeName AzureCatalog).Count
```

- To use any previous version to update the machine catalog:

```
1 Set-ProvScheme -ProvisioningSchemeName AzureCatalog -Version 2  
2 <!--NeedCopy-->
```

- To manually delete a version if it is not used by a VM of that machine catalog:

```
1 Remove-ProvSchemeVersion -ProvisioningSchemeName AzureCatalog -  
Version 3  
2 <!--NeedCopy-->
```

- To set the maximum number of versions to be retained by the machine catalog (default is 99). This setting is applied across all the catalogs. For example, in this case, a maximum of 15 versions will be retained for all the MCS provisioned catalogs.

```
1 Set-ProvServiceConfigurationData -Name "MaxProvSchemeVersions" -  
Value 15  
2 <!--NeedCopy-->
```

If the number of versions reaches the maximum number of versions, then a new version cannot be created if older versions are in use by any of the VMs in the machine catalog. In that case, do one of the following:

- Increase the limit of the maximum number of versions to be retained by the machine catalog.
- Update some VMs that are on older versions so that those older versions are no longer referenced by any VMs, and can be deleted.

Convert a non-machine profile-based machine catalog to machine profile-based machine catalog

You can use a VM, template spec (in case of Azure), or launch template (in case of AWS) as a machine profile input to convert a non-machine profile-based machine catalog to machine profile-based machine catalog. New VMs added to the catalog take property values from the machine profile unless overwritten by explicit custom property.

Note:

An existing machine profile-based machine catalog cannot be changed to a non-machine profile-based machine catalog.

To do this:

1. Create a persistent or non-persistent machine catalog with VMs and without a machine profile.
2. Open the **PowerShell** window.
3. Run the `Set-ProvScheme` command to apply the property values from the machine profile to the new VMs added to the machine catalog. For example:

- In the case of Azure:

```
1 Set-ProvScheme = Set-ProvScheme -ProvisioningSchemeName xxxx
   -MachineProfile XDHyp:\HostingUnits\\
   machineprofile.folder\\<
   TemplateSpecName>\
2 <!--NeedCopy-->
```

- In the case of AWS:

```
1 Set-ProvScheme = Set-ProvScheme -ProvisioningSchemeName xxxx
   -MachineProfile "XDHyp:\HostingUnits\\<
   launch-template>.launchtemplate\

```

Repair the identity information of active computer accounts

You can reset the identity information of active computer accounts that have identity-related problems. You can choose to reset only the machine password and trust keys, or reset all configuration of the identity disk. This implementation is applicable to both persistent and non-persistent MCS machine catalogs.

Note:

Currently, the feature is supported only for Azure and VMware virtualization environments.

Conditions

Ensure the following to successfully reset the identity disk:

- Turn off and set the VM to maintenance mode
- Do not include the parameter `-OS` in the PowerShell command

Reset identity disk

To reset identity disk:

1. Open the **PowerShell** window.
2. Run `asnp citrix*` to load the Citrix-specific PowerShell modules.
3. Reset the identity information.
 - To reset only the machine password and trust keys, run the following commands in the following order:

```
1 Repair-AcctIdentity -IdentityAccountName TEST\VM1 -  
   PrivilegedUserName TEST\admin1 -PrivilegedUserPassword  
   $password -Target IdentityInfo  
2 <!--NeedCopy-->
```

The descriptions of the parameters used in the command are as follows:

- `IdentityAccountName`: The name of the identity account that must be repaired.
- `PrivilegedUserName`: User account that has write permission on identity provider (AD or AzureAD).
- `PrivilegedUserPassword`: Password for PrivilegedUserName.
- `Target`: Target for the repair action. It can be `IdentityInfo` to repair account password/trust key, and `UserCertificate` to repair user certificate attributes of Hybrid AzureAD joined machine identities.

```
1 Reset-ProvVMDisk -ProvisioningSchemeName <name> -VMname <name  
   > -Identity -ResetIdentityInfo  
2 <!--NeedCopy-->
```

`ResetIdentityInfo` parameter resets the following:

- Password and trust keys: If the VM is AD domain joined (for DaaS doc only)

- Trust keys only: If the VM is not AD domain joined (for DaaS doc only)
- Password only: If the VM is AD domain joined (for CVAD on-prem doc only)
- To reset all configuration of the identity disk, run the following commands in the following order:

```
1 Repair-AcctIdentity -IdentityAccountName TEST\VM1 -
   PrivilegedUserName TEST\admin1 -PrivilegedUserPassword
   $password -Target IdentityInfo
2 <!--NeedCopy-->
```

```
1 Reset-ProvVMDisk ProvisioningSchemeName <name> -VMName <name>
   -Identity
2 <!--NeedCopy-->
```

4. Type **y** to confirm the action. You can also skip the confirmation prompt using the `-Force` parameter. For example:

```
1 Reset-ProvVMDisk -ProvisioningSchemeName <name> -VMName <name> -
   Identity -Force
2 <!--NeedCopy-->
```

5. Run `Get-ProvVM -ProvisioningSchemeName <name> -VMName <name>` to check the updated identity disk setting. The attributes of the identity disk (for example, `IdentityDiskId`) must be updated. The `StorageId` and `IdentityDiskIndex` must not change.

Change cache configuration on an existing machine catalog

After creating a non-persistent catalog with MCSIO enabled, you can use the `Set-ProvScheme` command to modify the following parameters:

- `WriteBackCacheMemorySize`
- `WriteBackCacheDiskSize`

This feature is currently applicable to:

- GCP and Microsoft Azure environments, and
- a non-persistent catalog with MCSIO enabled

Requirements

The requirements to modify the cache configuration are:

- Update to the latest version of VDA (2308 or later).

- Enable the parameter `UseWriteBackCache` for the existing machine catalog. Use `New-ProvScheme` to create a machine catalog with `UseWriteBackCache` enabled. For example:

```
1 New-ProvScheme -ProvisioningSchemeName $CatalogName -
   HostingUnitUid $HostingUnitUid `
2 -IdentityPoolUid $acctPool.IdentityPoolUid -CleanOnBoot `
3 -MasterImageVM $MasterImage `
4 -ServiceOffering $ServiceOffering `
5 -NetworkMap $NetworkMap `
6 -SecurityGroup $SecurityGroup `
7 -UseWriteBackCache -WriteBackCacheDiskSize 8
8 <!--NeedCopy-->
```

Change the cache configuration

Run the `Set-ProvScheme` command. For example:

```
1 Set-ProvScheme -ProvisioningSchemeName $provScheme.
   ProvisioningSchemeName -WriteBackCacheDiskSize 32 -
   WriteBackCacheMemorySize 128
2 <!--NeedCopy-->
```

Note:

- The value of `WriteBackCacheDiskSize` must be more than zero because at least 1 GB of cache disk storage is required.
- The value of `WriteBackCacheMemorySize` must be less than the machine catalog memory size.
- These changes only affect new VMs added to the catalog after the change is made. Existing VMs are not affected by these changes.

VDA Update Support via Local File Share Access

Specify the VDA installer location through PowerShell cmdlets which reduces your effort from providing network rules to allow each VDA to go and fetch the new VDA installer from the Citrix Managed Azure CDN.

PowerShell cmdlets

Two new optional parameters added to `New-VusCatalogSchedule` and `New-VusMachineUpgrade` cmdlets that allow you to use installers from a local file share

- `VdaWorkstationPackageUri` - to specify the UNC path to the workstation OS VDA installer

- **VdaServerPackageUri** - to specify the UNC path to the server OS VDA installer

Prerequisites

- VUS Agent Installer that comes with VDA 2311
- VDA Upgrade Agent to version 7.40.0.35 or later (using the VDA installer version 2311 or later)
- Virtual Apps and Desktops Remote PowerShell SDK version 7.40 or newer (released on Jan 10, 2024 or later)

How to Set File Share Permissions

The network shares containing VDA installer packages must have read access for the VDA Upgrade Agent service which runs as Local System (NT AUTHORITY\SYSTEM principal).

• **Domain-Joined file share permission**

When the VDA machine is domain-joined, then the **Local System** account (VUA runs as Local System), uses computer credentials when accessing network shares.

The least privilege permission can be set by granting the **Read** access to Domain Computers.

1. Choose people on your network who you want to share the file with.
2. Click **Advanced Sharing Settings** and turn on **File and Printer Sharing**.

• **Non-Domain Joined file share permission**

When the VDA machine is non-domain joined, then the **Local System** account (VUA runs as Local System), uses **ANONYMOUS LOGON** when accessing network shares.

1. Select a shared folder.
2. Disable the password protection.
 - a) Go to Folder **Properties**.
 - b) Select **Network and Sharing Center**.
 - c) Turn off **Password Protected Sharing**.
3. Click **Advanced Sharing** to grant a share permission.
 - a) Select **Permissions**.
 - b) Grant a **Read** share permission to **ANONYMOUS LOGON**.
4. Select the **Security Tab** to grant folder permissions
 - a) Click **Edit** to add permissions to the shared folder
 - b) Select the shared folder to grant folder permissions to **ANONYMOUS LOGON**.
5. Click **Advanced** to turn on **File and Printer Sharing**.
6. Add the shared folder name to **Network Access Security Policy**.

Note:

Restart your machine for the change to take effect immediately.

VDA Updates from a Local File Share

1. Download the VDA installer and place it in the shared file.

Note:

With Virtual Upgrade Service, you can select from either the Current Release track or the LTSR track.

For Example: If the machine catalog is set to Current Release that is 2311, and the VDA version is 2305, you must upgrade the VDA to version 2311.

- a) Navigate to the **Downloads** page on [our website](#).
 - b) Select **Citrix Virtual Apps and Desktops** as the product.
 - c) Select **Citrix Virtual Apps and Desktops 7 2311, All Editions**.
 - d) Select the VDA installer from the **Components that are on product ISO but also packaged separately** expandable.
2. Select the relevant VDA installer based on the catalog type.
 - Download the **Multi-session OS VDA installer** if the catalog type is **multi session**
 - Download the **Single-session OS VDA installer** if the catalog type is **single session**
 - Download the **Single-session OS Core Services VDA installer** if the catalog type is **Remote PC Access**

Note:

The version of the file share installer has to **exactly** match the version of the latest installer version published by VUS to the cloud.

Troubleshoot

- For machines with “Power State Unknown” status, see [CTX131267](#) for guidance.
- To fix VMs that continuously show an unknown power state, see [How to fix VMs that continuously show an unknown power state](#).

Where to go next

For information on managing specific cloud services catalogs, see:

- [Manage an AWS catalog](#)
- [Manage a XenServer catalog](#)
- [Manage a Google Cloud Platform catalog](#)
- [Manage a Microsoft Azure catalog](#)
- [Manage a Microsoft System Center Virtual Machine Manager catalog](#)
- [Manage a VMware catalog](#)

Manage an AWS catalog

December 18, 2023

[Manage machine catalogs](#) describes the wizards that manage a machine catalog. The following information covers details specific to AWS cloud environments.

Note:

Before managing an AWS catalog, you need to finish creating an AWS catalog. See [Create an AWS catalog](#).

Remove tags

When you create a catalog or a VM, MCS- created tags are created on the following resources:

- Virtual machine
- Root disk volume
- Identity disk volume
- NIC
- Root disk image (AMI)
- Launch template
- Snapshot of AMI or root disk

You can remove VMs and machine catalogs from Citrix database and remove MCS- created tags. You can use:

- `Remove-ProvVM` with `ForgetVM` parameter to remove VMs and MCS- created tags from a single VM or a list of VMs from a machine catalog.
- `Remove-ProvScheme` with `ForgetVM` parameter to remove a machine catalog from the Citrix database and resources from a machine catalog.

This feature is only applicable to persistent VMs.

To do this:

1. Open a **PowerShell** window.
2. Run `asnp citrix*` to load the Citrix-specific PowerShell modules.
3. Unlock the VM before removing the VMs. For example:

```
1 Unlock-ProvVM -ProvisioningSchemeName "<name>" -VMID "<id>"
2 <!--NeedCopy-->
```

4. Run one of the following commands to remove VMs, machine catalog, and MCS- created tags from resources.

- Run `Remove-ProvVM` with `ForgetVM` to remove VMs from Citrix database and tags from VMs. For example:

```
1 Remove-ProvVM -ProvisioningSchemeName "<name>" -VMName "<name>" -ForgetVM
2 <!--NeedCopy-->
```

- Run `Remove-ProvScheme` to remove machine catalog from Citrix database and resources from a machine catalog. For example:

```
1 Run Remove-ProvScheme -ProvisioningSchemeName "<name>" -ForgetVM
2 <!--NeedCopy-->
```

5. Verify that the VM is removed from the Delivery Controller, however, not from the hypervisor.
 - a) Run `Get-ProvVM -ProvisioningSchemeName "<name>" -VMName "<name>"`. This must return nothing.
 - b) Go to AWS EC2 console. You must see the VMs, however, the tags are now removed. Tags from the following resources are removed:
 - Virtual machine
 - Root disk volume
 - Identity disk volume
 - NIC
6. If you remove the machine catalog, verify that the catalog is removed from the Delivery Controller.
 - a) Run `Get-ProvScheme -ProvisioningSchemeName "forgetvmdemo"`. This must return an error.
 - b) Verify in AWS EC2 console that the following resources are removed.
 - Root disk image (AMI)
 - Launch template
 - Snapshot of AMI or root disk

Identify resources created by MCS

Following are the tags that MCS adds to the resources. The tags in the table are represented as “key” :”value”.

| Resource name | Tag |
|--------------------|--|
| ID disk | “Name”: “VMName_IdentityDisk”
“XdConfig”: “XdProvisioned=true” |
| Image | “CitrixProvisioningSchemeld”:
“xxxxxxxx-xxxx-xxxx-xxxx-xxxxxxxxxxxxx”
“XdConfig”: “XdProvisioned=true”
“CitrixProvisioningSchemeld”:
“xxxxxxxx-xxxx-xxxx-xxxx-xxxxxxxxxxxxx” |
| NIC | “Description”: “XD NIC”
“XdConfig”: “XdProvisioned=true”
“CitrixProvisioningSchemeld”:
“xxxxxxxx-xxxx-xxxx-xxxx-xxxxxxxxxxxxx” |
| OS disk | “Name”: “VMName_rootDisk”
“XdConfig”: “XdProvisioned=True”
“CitrixProvisioningSchemeld”:
“xxxxxxxx-xxxx-xxxx-xxxx-xxxxxxxxxxxxx”
[when AwsCaptureInstanceProperties = true]
“Citrix Resource”: “”
[when AwsCaptureInstanceProperties = true and
AwsOperationalResourcesTagging = true]
“CitrixOperationalResource”: “” |
| PrepVM | “Name”: “Preparation - CatalogName -
xxxxxxxx”
“XdConfig”: “XdProvisioned=true”
“CitrixProvisioningSchemeld”:
“xxxxxxxx-xxxx-xxxx-xxxx-xxxxxxxxxxxxx”
[when AwsCaptureInstanceProperties = true]
“Citrix Resource”: “”
[when AwsCaptureInstanceProperties = true and
AwsOperationalResourcesTagging = true]
“CitrixOperationalResource”: “” |
| Published snapshot | “XdConfig”: “XdProvisioned=true” |

| Resource name | Tag |
|---------------------------|--|
| Template | <p>If not a snapshot for Volume Worker AMI, then
 “CitrixProvisioningSchemeld”:
 “xxxxxxxx-xxxx-xxxx-xxxx-xxxxxxxxxxxxx”
 [when AwsCaptureInstanceProperties = true]
 “XdConfig”: “XdProvisioned=true”
 [when AwsCaptureInstanceProperties = true]
 “CitrixProvisioningSchemeld”:
 “xxxxxxxx-xxxx-xxxx-xxxx-xxxxxxxxxxxxx”
 [when AwsCaptureInstanceProperties = true]
 “CitrixResource”: “”
 [when AwsCaptureInstanceProperties = true and
 AwsOperationalResourcesTagging = true]
 “CitrixOperationalResource”: “”</p> |
| VM in catalog | <p>“XdConfig”: “XdProvisioned=true”
 “CitrixProvisioningSchemeld”:
 “xxxxxxxx-xxxx-xxxx-xxxx-xxxxxxxxxxxxx”
 [when AwsCaptureInstanceProperties = true]
 “CitrixResource”: “”
 [when AwsCaptureInstanceProperties = true]
 “aws:ec2launchtemplate:id”: “lt-xxxx”
 [when AwsCaptureInstanceProperties = true]
 “aws:ec2launchtemplate:version”: “n”
 [when AwsCaptureInstanceProperties = true and
 AwsOperationalResourcesTagging = true]
 “CitrixOperationalResource”: “”</p> |
| Volume worker AMI | <p>“XdConfig”: “XdProvisioned=true”</p> |
| Volume worker bootstraper | <p>“Name”: “XenDesktop Temp”
 “XdConfig”: “XdProvisioned=true”
 “CitrixProvisioningSchemeld”:
 “xxxxxxxx-xxxx-xxxx-xxxx-xxxxxxxxxxxxx”
 [when AwsCaptureInstanceProperties = true and
 AwsOperationalResourcesTagging = true]
 “CitrixVolumeWorkerBootstrapper”: “”</p> |
| Volume worker instance | <p>“Name”:
 “Citrix.XD.Volumeworker-xxxx-xx-xx-xx-xxxx”
 “XdConfig”: “XdProvisioned=true”</p> |

More information

- [Create and manage connections and resources](#)
- [Connection to AWS](#)
- [Create machine catalogs](#)
- [Create an AWS catalog](#)
- [Manage machine catalogs](#)

Manage a XenServer catalog

November 9, 2023

[Manage machine catalogs](#) describes the wizards that manage a machine catalog. The following information covers details specific to XenServer virtualization environments.

Note:

Before managing a XenServer catalog, you need to finish creating a XenServer catalog. See [Create a XenServer catalog](#).

Identify resources created by MCS

Following are the tags that MCS adds to the resources. The tags in the table are represented as “key”:”value”.

| Resource name | Tag |
|---|---|
| Published base disk and its copy on each network or local storage | “CitrixProvisioningSchemeld”:
“XXXXXXXX-XXXX-XXXX-XXXX-XXXXXXXXXXXX” |
| ID disk | “CitrixProvisioningSchemeld”:
“XXXXXXXX-XXXX-XXXX-XXXX-XXXXXXXXXXXX” |
| OS disk | “CitrixProvisioningSchemeld”:
“XXXXXXXX-XXXX-XXXX-XXXX-XXXXXXXXXXXX” |
| Prep VM | “CitrixProvisioningSchemeld”:
“XXXXXXXX-XXXX-XXXX-XXXX-XXXXXXXXXXXX” |
| VM in catalog | “CitrixProvisioningSchemeld”:
“XXXXXXXX-XXXX-XXXX-XXXX-XXXXXXXXXXXX” |
| WBC disk | “CitrixProvisioningSchemeld”:
“XXXXXXXX-XXXX-XXXX-XXXX-XXXXXXXXXXXX” |

More information

- [Create and manage connections and resources](#)
- [Connection to XenServer](#)
- [Create machine catalogs](#)
- [Create a XenServer catalog](#)
- [Manage machine catalogs](#)

Manage a Google Cloud Platform catalog

June 27, 2023

[Manage machine catalogs](#) describes the wizards that manage a machine catalog. The following information covers details specific to Google cloud environments.

Note:

Before managing a Google Cloud Platform catalog, you need to finish creating a Google Cloud Platform catalog. See [Create a Google Cloud Platform catalog](#).

Manage machine catalog

To add machines to a catalog, update machines, and roll back an update, see [Manage machine catalogs](#).

Power management

Citrix DaaS lets your power management of Google Cloud machines. Use the **Search** node in the left pane to locate the machine you want to power manage. The following power actions are available:

- Delete
- Start
- Restart
- Force Restart
- Shut Down
- Force Shutdown
- Add to Delivery Group
- Manage Tags
- Turn On Maintenance Mode

You can also power manage Google Cloud machines by using Autoscale. To do so, add the Google Cloud machines to a Delivery Group and then enable Autoscale for that Delivery Group. For more information about Autoscale, see [Autoscale](#).

Update provisioned machines using PowerShell

The `Set-ProvScheme` command changes the provisioning scheme. However, it does not affect existing machines. Using the PowerShell command `Set-ProvVMUpdateTimeWindow`, you can now apply the current provisioning scheme to an existing persistent or non-persistent machine or set of machines. Currently, in GCP, the property update supported by this feature is machine profile.

You can update:

- A single VM
- A list of specific VMs or all existing VMs associated with a provisioning scheme ID
- A list of specific VMs or all existing VMs associated with a provisioning scheme name

To update the existing VMs:

1. Check the configuration of the existing machines. For example,

```
1 Get-ProvScheme | select ProvisioningSchemeName,  
   ProvisioningSchemeVersion  
2 <!--NeedCopy-->
```

2. Update the provisioning scheme. For example,

```
1 `Set-ProvScheme - ProvisioningSchemeName "my-catalog" -  
   MachineProfile "XDHyp:\HostingUnits\<hosting-unit>\  
   machineprofileinstance.vm"  
2 <!--NeedCopy-->
```

3. Check if the current property of the VM matches the current provisioning scheme, and if there is any pending update action on the VM. For example,

```
1 Get-ProvVM | select VMName, ProvisioningSchemeUpdateRequested,  
   ProvisioningSchemeVersion  
2 <!--NeedCopy-->
```

You can also find machines with a particular version. For example,

```
1 Get-ProvVM -Filter "ProvisioningSchemeVersion -eq 1" | select  
   VMName, ProvisioningSchemeVersion  
2 <!--NeedCopy-->
```

4. Update existing machines.

- To update all the existing machines:

```

1 Set-ProvVMUpdateTimeWindow -ProvisioningSchemeName my-catalog
  -StartsNow -DurationInMinutes -1
2 <!--NeedCopy-->

```

- To update a list of specific machines:

```

1 Set-ProvVMUpdateTimeWindow -ProvisioningSchemeName my-catalog
  -VMName <List-Of-Vm-Names> -StartsNow -DurationInMinutes
  -1
2 <!--NeedCopy-->

```

- To update machines based on the output of `Get-ProvVM`:

```

1 Get-ProvVM -ProvisioningSchemeName "my-catalog" | Set-
  ProvVMUpdateTimeWindow -ProvisioningSchemeName my-catalog
  -StartsNow -DurationInMinutes -1
2 <!--NeedCopy-->

```

5. Find machines with an update scheduled. For example,

```

1 Get-ProvVM -Filter "ProvisioningSchemeUpdateAfter" | select VMName
  , ProvisioningSchemeUpdateAfter
2 <!--NeedCopy-->

```

6. Restart the machines. At the next power-up, property changes are applied to the existing machines. You can check the updated status using the following command:

```

1 Get-ProvVM | select VMName, ProvisioningSchemeUpdateRequested,
  ProvisioningSchemeVersion
2 <!--NeedCopy-->

```

Change disk related custom properties of an existing catalog

You can change the following disk related custom properties of an existing catalog and existing VMs of the catalog:

- `PersistOSDisk`
- `PersistWBC`
- `StorageType`
- `IdentityDiskStorageType`
- `WbcDiskStorageType`

Note:

- `StorageType` property is for OS disk
- `PersistOsDisk` property can be set only for non-persistent catalog with write-back

cache enabled

This implementation helps you to select different storage types for different disks even after you create a catalog and thus, balance pricing associated with different storage types.

To do this, use PowerShell commands `Set-ProvScheme` and `Set-ProvVMUpdateTimeWindow` :

1. Open a **PowerShell** window.
2. Run `asnp citrix*`.
3. Run `Get-ProvVM -VMName <VM name>` to get the custom properties.
4. Change the custom properties string:
 - a) Copy the custom properties to a Notepad and change the custom properties.
 - b) In the **PowerShell** window, paste the modified custom properties from Notepad and assign a variable to the modified custom properties. For example:

```

1 $cp = '<CustomProperties xmlns=http://schemas.citrix.com
      /2014/xd/machinecreation xmlns:xsi="http://www.w3.org/2001/
      XMLSchema-instance">
2 <Property xsi:type="StringProperty" Name="CatalogZones" Value
      ="" />
3 <Property xsi:type="StringProperty" Name="PersistWBC" Value="
      true" />
4 <Property xsi:type="StringProperty" Name="PersistOSDisk" Value
      ="true" />
5 <Property xsi:type="StringProperty" Name="WBCDiskStorageType"
      Value="pd-standard" />
6 <Property xsi:type="StringProperty" Name="StorageType" Value="
      pd-standard" />
7 </CustomProperties>'
8 <!--NeedCopy-->

```

5. Update the existing catalog. For example:

```

1 Set-ProvScheme -ProvisioningSchemeName <yourCatalogName> -
      CustomProperties $cp
2 <!--NeedCopy-->

```

6. Update the existing VMs. For example:

```

1 Set-ProvVMUpdateTimeWindow -ProvisioningSchemeName my-catalog -
      VMName <List-Of-Vm-Names> -StartsNow -DurationInMinutes -1
2 <!--NeedCopy-->

```

7. Restart the VMs. At the next power up, custom property changes are applied to the existing VMs.

Protect accidental machine deletion

Citrix DaaS lets you protect MCS resources on the Google Cloud to prevent accidental deletion. Configure the provisioned VM by setting the `deletionProtection` flag to TRUE.

By default, VMs provisioned through MCS or Google Cloud plug-in are created with InstanceProtection enabled. The implementation is applicable to both persistent and non-persistent catalogs. The non-persistent catalogs are updated when the instances get re-created from the template. For existing persistent machines, you can set the flag in the Google Cloud console. For more information about setting the flag, see the [Google Documentation site](#). New machines added to persistent catalogs are created with `deletionProtection` enabled.

If you attempt to delete a VM instance for which you have set the `deletionProtection` flag, the request fails. However, if you are granted the permission `compute.instances.setDeletionProtection` or assigned the IAM **Compute Admin** role, you can reset the flag to allow the resource to be deleted.

Identify resources created by MCS

Following are the tags that MCS adds to the resources. The tags in the table are represented as “key” :”value”.

| Resource name | Tag |
|--------------------|--|
| ID disk | “CitrixResource”: “internal” |
| | “CitrixProvisioningSchemeId”:
“xxxxxxxx-xxxx-xxxx-xxxx-xxxxxxxxxxxxx” |
| Image | “CitrixResource”: “internal” |
| | “CitrixProvisioningSchemeId”:
“xxxxxxxx-xxxx-xxxx-xxxx-xxxxxxxxxxxxx” |
| OS disk | “CitrixResource”: “internal” |
| | “CitrixProvisioningSchemeId”:
“xxxxxxxx-xxxx-xxxx-xxxx-xxxxxxxxxxxxx” |
| PrepVM | “CitrixResource”: “internal” |
| | “CitrixProvisioningSchemeId”:
“xxxxxxxx-xxxx-xxxx-xxxx-xxxxxxxxxxxxx” |
| Published snapshot | “CitrixResource”: “internal” |
| Storage bucket | “Citrixresource”: “internal” |
| Template | “CitrixResource”: “internal” |

| Resource name | Tag |
|---------------|--|
| VM in catalog | <p>“CitrixProvisioningSchemeId”:
 “xxxxxxxx-xxxx-xxxx-xxxx-xxxxxxxxxxxxx”
 “CitrixResource”: “internal”</p> <p>“CitrixProvisioningSchemeId”:
 “xxxxxxxx-xxxx-xxxx-xxxx-xxxxxxxxxxxxx”. The plug-in also adds this label for MCS provisioned VMs: “citrix-provisioning-scheme-id”:
 “provSchemeId”. You can use this label to filter by catalog in the GCP console.</p> |
| WBC disk | <p>“CitrixResource”: “internal”</p> <p>CitrixProvisioningSchemeId”:
 “xxxxxxxx-xxxx-xxxx-xxxx-xxxxxxxxxxxxx”</p> |

Note:

A VM is not visible in the Citrix inventory if a **CitrixResource** tag is added to identify it as a resource created by MCS. You can remove or rename the tag to make it visible.

More information

- [Create and manage connections and resources](#)
- [Connection to Google cloud environments](#)
- [Create machine catalogs](#)
- [Create a Google Cloud Platform catalog](#)
- [Manage machine catalogs](#)

Manage an HPE Moonshot catalog

April 16, 2024

[Manage machine catalogs](#) describes the wizards that manage a machine catalog. The following information covers details specific to HPE Moonshot catalog.

Note:

Before managing a HPE Moonshot catalog, you need to finish creating a HPE Moonshot catalog.

Power management

Citrix Virtual Apps and Desktops lets you do power management of HPE Moonshot machines. Use the **Search** node in the navigation pane to locate the machine you want to power manage. The following power actions are available:

- Start
- Shut Down
- Force Shutdown
- Restart
- Reset

Note:

Suspend and **Resume** power actions are not supported.

More information

- [Create and manage connections and resources](#)
- [Connection to HPE Moonshot](#)
- [Create machine catalogs](#)
- [Create an HPE Moonshot machine catalog](#)
- [Manage machine catalogs](#)

Manage a Microsoft Azure catalog

December 15, 2023

[Manage machine catalogs](#) describes the wizards that manage a machine catalog. The following information covers details specific to Microsoft Azure Resource Manager cloud environments.

Note:

Before managing a Microsoft Azure catalog, you need to finish creating a Microsoft Azure catalog. See [Create a Microsoft Azure catalog](#).

Change the storage type to a lower tier when a VM is shut down

You can save storage costs by switching the storage type of a managed disk to a lower tier when you shut down a VM. To do this, use the `StorageTypeAtShutdown` custom property.

The storage type of the disk changes to a lower tier (as specified in the `StorageTypeAtShutdown` custom property) when you shut down the VM. After you power on the VM, the storage type changes back to the original (as specified in `StorageType` custom property or `WBCDiskStorageType` custom property).

Important:

The disk does not exist until the VM is powered on at least once. Therefore, you cannot change the storage type when you first power on the VM.

Requirements

- Applicable to a managed disk. This implies that you set the custom property `UseManagedDisks` to true.
- Applicable to a persistent and non-persistent catalog with a persistent OS disk. This implies that you set the custom property `persistOsDisk` to true.
- Applicable to a non-persistent catalog with a persistent WBC disk. This implies that you set the custom property `persistWBC` to true.

Restriction

- As per Microsoft, you can only change the disk type twice per day. See the [Microsoft document](#). As per Citrix, the `StorageType` update happens whenever there is a Start or Deallocate action for the VM. Therefore, limit the number of power actions per VM to twice per day. For example, one power action in the morning to start the VM and one in the evening to deallocate the VM.

Change the storage type to a lower tier

Before proceeding with the steps, see the Requirements and Restriction.

1. Add the custom property `StorageTypeAtShutdown`, set the value to `Standard_LRS` (HDD), and create a catalog using `New-ProvScheme`. For information on creating a catalog using PowerShell, see <https://developer-docs.citrix.com/projects/citrix-virtual-apps-desktops-sdk/en/latest/creating-a-catalog/>.

Note:

If `StorageTypeAtShutdown` has any value other than empty or `Standard_LRS` (HDD), the operation fails.

Example of setting custom properties while creating a persistent catalog:

```
1 $customProperties='<CustomProperties xmlns="http://schemas.citrix.com/2014/xd/machinecreation"
2 xmlns:xsi="http://www.w3.org/2001/XMLSchema-instance">
3 <Property xsi:type="StringProperty" Name="UseManagedDisks" Value="
4 true" />
5 <Property xsi:type="StringProperty" Name="StorageType" Value="
6 Premium_LRS" />
7 <Property xsi:type="StringProperty" Name="ResourceGroups" Value=""
8 />
9 <Property xsi:type="StringProperty" Name="LicenseType" Value="
10 Windows_Client" />
11 <Property xsi:type="StringProperty" Name="SchemaVersion" Value="2"
12 />
13 <Property xsi:type="StringProperty" Name="OsType" Value="Windows"
14 />
15 <Property xsi:type="StringProperty" Name="StorageTypeAtShutdown"
16 Value="Standard_LRS" />
17 </CustomProperties>'
18 <!--NeedCopy-->
```

Example of setting custom properties while creating a non-persistent catalog:

```
1 $customProperties='<CustomProperties xmlns="http://schemas.citrix.com/2014/xd/machinecreation"
2 xmlns:xsi="http://www.w3.org/2001/XMLSchema-instance">
3 <Property xsi:type="StringProperty" Name="UseManagedDisks" Value="
4 true" />
5 <Property xsi:type="StringProperty" Name="StorageType" Value="
6 Premium_LRS" />
7 <Property xsi:type="StringProperty" Name="WbcDiskStorageType"
8 Value="Standard_SSD_LRS" />
9 <Property xsi:type="StringProperty" Name="ResourceGroups" Value=""
10 />
11 <Property xsi:type="StringProperty" Name="LicenseType" Value="
12 Windows_Client" />
13 <Property xsi:type="StringProperty" Name="SchemaVersion" Value="2"
14 />
15 <Property xsi:type="StringProperty" Name="OsType" Value="Windows"
16 />
17 <Property xsi:type="BooleanProperty" Name="persistWBC" Value=true
18 />
19 <Property xsi:type="BooleanProperty" Name="persistOsDisk" Value=
20 true />
21 <Property xsi:type="StringProperty" Name="StorageTypeAtShutdown"
22 Value="Standard_LRS" />
23 </CustomProperties>'
24 <!--NeedCopy-->
```

Note:

When you use a machine profile, the custom property takes precedence over the property defined in `MachineProfile`.

2. Shut down the VM and check the storage type of the VM in the Azure portal. The storage type of the disk changes to a lower tier, as specified in the `StorageTypeAtShutdown` custom property.
3. Turn on the VM. The storage type of the disk switches back to the storage type mentioned in:
 - `StorageType` custom property for OS disk
 - `WBCDiskStorageType` custom property for WBC disk only if you specify it in `CustomProperties`. Otherwise, it switches back to the storage type mentioned in `StorageType`.

Apply `StorageTypeAtShutdown` to an existing catalog

Before proceeding with the steps, see the Requirements and Restriction.

Use `Set-ProvScheme` to add a VM to an existing catalog. The feature applies to new VMs added after running `Set-ProvScheme`. The existing machines are not affected.

Example of setting custom properties while adding a VM to an existing catalog:

```

1 $customProperties='<CustomProperties xmlns="http://schemas.citrix.com
2 /2014/xd/machinecreation"
3 xmlns:xsi="http://www.w3.org/2001/XMLSchema-instance">
4 <Property xsi:type="StringProperty" Name="UseManagedDisks" Value="true"
5 />
6 <Property xsi:type="StringProperty" Name="StorageType" Value="
7 Premium_LRS" />
8 <Property xsi:type="StringProperty" Name="WbcDiskStorageType" Value="
9 Standard_SSD_LRS" />
10 <Property xsi:type="StringProperty" Name="ResourceGroups" Value="" />
11 <Property xsi:type="StringProperty" Name="LicenseType" Value="
12 Windows_Client" />
13 <Property xsi:type="StringProperty" Name="SchemaVersion" Value="2" />
14 <Property xsi:type="StringProperty" Name="OsType" Value="Windows" />
15 <Property xsi:type="BooleanProperty" Name="persistWBC" Value=true />
16 <Property xsi:type="BooleanProperty" Name="persistOsDisk" Value=true />
17 <Property xsi:type="StringProperty" Name="StorageTypeAtShutdown" Value
18 ="Standard_LRS" />
19 </CustomProperties>'
20
21 $ProvScheme = Get-Provscheme -ProvisioningSchemeName $CatalogName
22
23 Set-ProvScheme -ProvisioningSchemeName $ProvScheme.
24 ProvisioningSchemeName -CustomProperties $customProperties
25 <!--NeedCopy-->

```

Change the storage type of existing VMs to a lower tier on shutdown

Before proceeding with the steps, see the Requirements and Restriction.

You can save storage costs by changing the storage type of existing VMs to a lower tier when the VMs are shut down. To do this, use the `StorageTypeAtShutdown` custom property.

To change the Storage type of existing machines in a catalog to a lower tier when the VMs are shut down:

1. Open a PowerShell window.
2. Run `asnp citrix*` to load the Citrix-specific PowerShell modules.
3. Run `Get-ProvScheme -ProvisioningSchemeName $CatalogName`.
4. Change the custom properties string.

```
1 $customProperties = '<CustomProperties xmlns="http://schemas.
    citrix.com/2014/xd/machinecreation" xmlns:xsi="http://www.w3.
    org/2001/XMLSchema-instance">
2 <Property xsi:type="StringProperty" Name="StorageTypeAtShutdown"
    Value="Standard_LRS" />
3 </CustomProperties>'
4 <!--NeedCopy-->
```

5. Update the provisioning scheme of the existing catalog. The update applies to new VMs added after running `Set-ProvScheme`.

```
1 Set-ProvScheme -ProvisioningSchemeName $CatalogName -
    CustomProperties $customProperties
2 <!--NeedCopy-->
```

6. Update the existing VMs to enable `StorageTypeAtShutdown`.

```
1 Set-ProvVMUpdateTimeWindow -ProvisioningSchemeName $CatalogName -
    StartsNow -DurationInMinutes -1
2 <!--NeedCopy-->
```

7. When you power on the machines next time, the `StorageTypeAtShutdown` property of the machines is updated. The storage type changes at the next shutdown.
8. Run the following command to view the `StorageTypeAtShutdown` value for each VM in a catalog:

```
1 Get-ProvVM -ProvisioningSchemeName <catalog-name> | foreach {
2   $vmName = $_.VMName; $storageTypeAtShutdown = ($_.CustomVmData |
    ConvertFrom-Json).StorageTypeAtShutdown.
    DiskStorageAccountType; return New-Object psobject -Property
    @{
3     "VMName" = $vmName; "StorageTypeAtShutdown" =
    $storageTypeAtShutdown }
4   }
5
6 <!--NeedCopy-->
```

Update provisioned machines to current provisioning scheme state

The `Set-ProvScheme` command changes the provisioning scheme. However, it does not affect existing machines. Using the PowerShell command `Set-ProvVMUpdateTimeWindow`, you can apply the current provisioning scheme to an existing persistent or non-persistent machine or set of machines. You can also schedule a time slot for the configuration updates of the existing MCS provisioned machines. Any power on or restart during the scheduled time slot applies a scheduled provisioning scheme update to a machine. Currently, in Azure, you can update `ServiceOffering`, `MachineProfile` and the following custom properties:

- `StorageType`
- `WBCDiskStorageType`
- `IdentityDiskStorageType`
- `LicenseType`
- `DedicatedHostGroupId`
- `PersistWBC`
- `PersistOsDisk`
- `PersistVm`

Note:

- You can only update `StorageType`, `WBCDiskStorageType`, and `IdentityDiskStorageType` custom properties for a catalog using managed disk in Azure environments.
- If you run `Set-ProvVMUpdateTimeWindow` twice, then the most recent command takes effect.

You can update:

- A single VM
- A list of specific VMs or all existing VMs associated with a provisioning scheme ID
- A list of specific VMs or all existing VMs associated with a provisioning scheme name (machine catalog name)

After you make the following changes to the provisioning scheme, VM instance gets recreated for persistent catalogs in Azure:

- Change the `MachineProfile`
- Remove `LicenseType`
- Remove `DedicatedHostGroupId`

Note:

The OS disk of existing machines along with all its data remains as is and a new VM is attached to the disk.

Before updating the existing VMs:

1. Check the configuration of the existing machines. For example,

```
1 Get-ProvScheme | select ProvisioningSchemeName,
   ProvisioningSchemeVersion
2 <!--NeedCopy-->
```

2. Update the provisioning scheme. For example,

- With VM as a machine profile input:

```
1 Set-ProvScheme -ProvisioningSchemeName "my-catalog" -
   MachineProfile "XDHyp:\HostingUnits\<hosting-unit>\
   machineprofile.folder\<resource-group>.resourcegroup\<
   virtual-machine>.vm"
2 <!--NeedCopy-->
```

- With template spec as a machine profile input:

```
1 Set-ProvScheme -ProvisioningSchemeName "my-catalog"
2 -MachineProfile "XDHyp:\HostingUnits\<hosting-unit>\
   machineprofile.folder\<resource-group>.resourcegroup\<
   template-spec>.templatespec\<template-spec-version>.
   templatespecversion"
3 -ServiceOffering "XDHyp:\HostingUnits\<hosting-unit>\
   serviceoffering.folder\<service-offering>.serviceoffering"
4 <!--NeedCopy-->
```

- With just service offering:

```
1 Set-ProvScheme -ProvisioningSchemeName "my-catalog" -
   ServiceOffering "XDHyp:\HostingUnits\<hosting-unit>\
   serviceoffering.folder\<service-offering>.serviceoffering"
2 <!--NeedCopy-->
```

3. Check if the current property of the VM matches the current provisioning scheme, and if there is any pending update action on the VM. For example,

```
1 Get-ProvVM | select VMName, ProvisioningSchemeUpdateRequested,
   ProvisioningSchemeVersion
2 <!--NeedCopy-->
```

You can also find machines with a particular version. For example,

```
1 Get-ProvVM -Filter "ProvisioningSchemeVersion -eq 1" | select
   VMName, ProvisioningSchemeVersion
2 <!--NeedCopy-->
```

To request updates for existing machines to apply at the next restart:

1. Run the following commands to update existing machines and have the updates apply at the next restart.

- To update all the existing machines. For example,

```
1 Set-ProvVMUpdateTimeWindow -ProvisioningSchemeName my-catalog
   -StartsNow -DurationInMinutes -1
2 <!--NeedCopy-->
```

- To update a list of specific machines. For example,

```
1 Set-ProvVMUpdateTimeWindow -ProvisioningSchemeName my-catalog
   -VMName <List-Of-Vm-Names> -StartsNow -DurationInMinutes
   -1
2 <!--NeedCopy-->
```

- To update machines based on the output of Get-ProvVM. For example,

```
1 Get-ProvVM -ProvisioningSchemeName "my-catalog" | Set-
   ProvVMUpdateTimeWindow -ProvisioningSchemeName my-catalog
   -StartsNow -DurationInMinutes -1
2 <!--NeedCopy-->
```

Note:

- `StartsNow` indicates that the scheduled start time is the current time.
- `DurationInMinutes` with a negative number (for example, `-1`) indicates no upper bound on the schedule's time window.

2. Find machines with an update scheduled. For example,

```
1 Get-ProvVM -Filter "ProvisioningSchemeUpdateAfter" | select VMName
   , ProvisioningSchemeUpdateAfter
2 <!--NeedCopy-->
```

3. Restart the machines. At the next power-up, property changes are applied to the existing machines. You can check the updated status using the following command. For example,

```
1 Get-ProvVM | select VMName, ProvisioningSchemeUpdateRequested,
   ProvisioningSchemeVersion
2 <!--NeedCopy-->
```

To schedule a VM to update to the latest provisioning settings next time it starts in the scheduled time window:

1. Run the following commands:

- To schedule an update with start time as the current time

```

1 Set-ProvVMUpdateTimeWindow -ProvisioningSchemeName my-catalog
  -VMName vm1 -StartsNow -DurationInMinutes 120
2 <!--NeedCopy-->

```

- To schedule an update on a weekend

```

1 Set-ProvVMUpdateTimeWindow -ProvisioningSchemeName " my-
  catalog " -VMName " vm1 " -StartTimeInUTC " 10/15/2022
  9:00am " -DurationInMinutes (New - TimeSpan - Days 2).
  TotalMinutes
2 <!--NeedCopy-->

```

Note:

- **VMName** is optional. If not specified, the update is scheduled for the entire catalog.
- Instead of **StartTimeInUTC**, use **StartsNow** to indicate that the schedule start time is the current time.
- **DurationInMinutes** is optional. Default is 120 minutes. A negative number (for example, -1) indicates no upper bound on the schedule's time window.

2. Check the update status.

```

1 Get-ProvVM | select VMName, ProvisioningSchemeUpdateRequested,
  ProvisioningSchemeUpdateUntil, ProvisioningSchemeVersion
2 <!--NeedCopy-->

```

3. Power on the VM. If you power on the machine after the scheduled time slot, configuration update is not applied. If you power on the machine within the scheduled time slot,
 - If the machine is powered off, and
 - you do not power on the machine, configuration update is not applied
 - you power on the machine, configuration update is applied
 - If the machine is powered on, and
 - you do not restart the machine, configuration update is not applied
 - you restart the machine, configuration update is applied

To cancel the configuration update:

You can also cancel a configuration update of a single VM, multiple VMs, or an entire catalog. To cancel a configuration update:

1. Run `Clear-ProvVMUpdateTimeWindow`. For example:

- To cancel the configuration update scheduled for a single VM:

```

1 Clear-ProvVMUpdateTimeWindow -ProvisioningSchemeName " my-
  catalog " -VMName " vm1 "
2 <!--NeedCopy-->

```

- To cancel the configuration update scheduled for multiple VMs:

```

1 Clear-ProvVMUpdateTimeWindow -ProvisioningSchemeName "my-
  catalog" -VMName "vm1","vm2"
2 <!--NeedCopy-->

```

Note:

The VMs must be from the same catalog.

Update properties of individual VMs

You can update properties of individual VMs in a persistent MCS machine catalog using the PowerShell command `Set-ProvVM`. However, the updates are not applied immediately. You must set the time window using the PowerShell command `Set-ProvVMUpdateTimeWindow` for the updates to apply.

This implementation helps you to manage individual VMs efficiently without updating the entire machine catalog. Currently, this feature is applicable only to the Azure environment.

Currently, the properties that you can update are:

- `CustomProperties`
- `ServiceOffering`
- `MachineProfile`

Using this feature, you can:

- Update the properties of a VM
- Retain the properties updated on a VM after the machine catalog is updated
- Revert the configuration updates applied to a VM

Before updating properties of a VM:

1. Open a **PowerShell** window.
2. Run `asnp citrix*` to load the Citrix-specific PowerShell modules.
3. Check the configuration of the existing machine catalog. For example:

```

1 Get-ProvScheme -ProvisioningSchemeName AzureCatalog
2 <!--NeedCopy-->

```

4. Check the configuration of the VM on which you want to apply the updates. For example:

```
1 Get-ProvVM -ProvisioningSchemeName AzureCatalog -VMName machine1
2 <!--NeedCopy-->
```

Update properties of a VM

Do the following to update the properties on a VM:

1. Turn off the VM on which you want to apply the updates.
2. Update the properties of the VM. For example, if you want to update storage type (`StorageType`) custom property of the VM, run the following:

```
1 Set-ProvVM -ProvisioningSchemeName AzureCatalog -VMName machine1 -
  CustomProperties "...<Property Name='StorageType' Value='
  Premium_LRS' />..."
2 <!--NeedCopy-->
```

You can update properties of two VMs in a machine catalog simultaneously. For example:

```
1 Set-ProvVM -ProvisioningSchemeName AzureCatalog -VMName machine1 -
  CustomProperties "...<Property Name='StorageType' Value='
  Premium_LRS' />..."
2 <!--NeedCopy-->
```

```
1 Set-ProvVM -ProvisioningSchemeName AzureCatalog -VMName machine2 -
  CustomProperties "...<Property Name='StorageType' Value='
  StandardSSD_LRS' />..."
2 <!--NeedCopy-->
```

Note:

The updates are not applied immediately.

3. Get the list of properties that are specified to be updated and the configuration version. For example:

```
1 Get-ProvVMConfiguration -ProvisioningSchemeName AzureCatalog -
  VMName machine1
2 <!--NeedCopy-->
```

Check the property value of `Version` and the properties to be updated (in this case, `StorageType`).

4. Check the configuration version. For example:

```
1 Get-ProvVM -ProvisioningSchemeName AzureCatalog -VMName machine1
2 <!--NeedCopy-->
```

Check the property value of `ProvVMConfigurationVersion`. The update is not yet applied. The VM is still in the old configuration.

5. Request scheduled update. For example:

```
1 Set-ProvVMUpdateTimeWindow -ProvisioningSchemeName AzureCatalog -
  StartsNow -DurationInMinutes -1
2 <!--NeedCopy-->
```

For more information on scheduled updates, see [Update provisioned machines to current provisioning scheme state](#).

Note:

Any pending provisioning scheme update is also applied.

6. Restart the VM. For example:

```
1 New-BrokerHostingPowerAction -MachineName machine1 -Action TurnOn
2 <!--NeedCopy-->
```

7. Check the configuration version. For example:

```
1 Get-ProvVM -ProvisioningSchemeName AzureCatalog -VMName machine1
2 <!--NeedCopy-->
```

Check the property value of `ProvVMConfigurationVersion`. The update is now applied. The VM now has the new configuration.

8. To apply further configuration updates on the VM, turn off the VM, and repeat the steps.

Retain the properties updated on a VM after the machine catalog is updated

Do the following to retain the properties updated on a VM:

1. Turn off the VM on which you want to apply the updates.
2. Update the machine catalog. For example, if you want to change the VM size (`ServiceOffering`) and storage type (`StorageType`), run the following:

```
1 Set-ProvScheme -ProvisioningSchemeName AzureCatalog -
  ServiceOffering Standard_E4_v3 -CustomProperties "...<Property
  Name='StorageType' Value='StandardSSD_LRS' />..."
2 <!--NeedCopy-->
```

3. Get the configuration details of the machine catalog. For example:

```
1 Get-ProvScheme -ProvisioningSchemeName AzureCatalog
2 <!--NeedCopy-->
```

The `ProvisioningSchemeVersion` is now incremented by one. The VM size and storage type are also updated.

4. Update the properties of the VM. For example, provide a machine profile to the VM.

```
1 Set-ProvVM -ProvisioningSchemeName AzureCatalog -VMName machine1 -
  MachineProfile "XDHyp:\HostingUnits\\
  machineprofile.folder\

```

Note:

The machine profile input has a tag and a different VM size (`ServiceOffering`) specified.

5. Get the list of properties that the VM will have after merging the configuration updates on the VM with the machine catalog updates. For example:

```
1 Get-ProvVMConfigurationResultantSet -ProvisioningSchemeName
  AzureCatalog -VMName machine1
2 <!--NeedCopy-->
```

Note:

Any updates on the VM will override the updates done on the machine catalog.

6. Request scheduled update for the VM. For example:

```
1 Set-ProvVMUpdateTimeWindow -ProvisioningSchemeName AzureCatalog -
  VMName machine1 -StartsNow -DurationInMinutes -1
2 <!--NeedCopy-->
```

7. Restart the VM. For example:

```
1 New-BrokerHostingPowerAction -MachineName machine1 -Action TurnOn
2 <!--NeedCopy-->
```

The VM keeps its updated VM size as derived from the machine profile. The tag values as specified in the machine profile are also applied to the VM. However, the storage type is derived from the latest provisioning scheme.

8. Get the configuration version of the VM. For example:

```
1 Get-ProvVM -ProvisioningSchemeName AzureCatalog -VMName machine1
2 <!--NeedCopy-->
```

The `ProvisioningSchemeVersion` and `ProvVMConfigurationVersion` now shows the latest version.

Revert the configuration updates applied to a VM

1. After applying the updates to a VM, turn off the VM.
2. Run the following command to remove the updates that are applied on the VM. For example:

```
1 Set-ProvVM -RevertToProvSchemeConfiguration -  
   ProvisioningSchemeName AzureCatalog -VMName machine1  
2 <!--NeedCopy-->
```

3. Request scheduled update for the VM. For example:

```
1 Set-ProvVMUpdateTimeWindow -ProvisioningSchemeName AzureCatalog -  
   VMName machine1 -StartsNow -DurationInMinutes -1  
2 <!--NeedCopy-->
```

4. Restart the VM. For example:

```
1 New-BrokerHostingPowerAction -MachineName machine1 -Action TurnOn  
2 <!--NeedCopy-->
```

5. Check the configuration version of the VM. For example:

```
1 Get-ProvVM -ProvisioningSchemeName AzureCatalog -VMName machine1  
2 <!--NeedCopy-->
```

The `ProvVMConfigurationVersion` value is now the configuration version of the machine catalog.

Retrieve information for Azure VMs, snapshots, OS disk, and gallery image definition

You can display information for an Azure VM, including OS disk and type, snapshot and gallery image definition. This information is displayed for resources on the master image when a machine catalog is assigned. Use this functionality to view and select either a Linux or Windows image. A PowerShell property, `TemplateIsWindowsTemplate`, was added to the `AdditionDatafield` parameter. This field contains Azure-specific information: VM type, OS disk, gallery image information, and OS type information. Setting `TemplateIsWindowsTemplate` to **True** indicates that the OS type is Windows; setting `TemplateIsWindowsTemplate` to **False** indicates that the OS type is Linux.

Tip:

Information displayed by the `TemplateIsWindowsTemplate` PowerShell property is derived from the Azure API. Sometimes, this field might be empty. For example, a snapshot from a data disk does not contain the `TemplateIsWindowsTemplate` field because the OS type cannot be retrieved from a snapshot.

For example, set the Azure VM `AdditionData` parameter to **True** for Windows OS type using PowerShell:

```

1 PS C:\Users\username> (get-item XDHyp:\HostingUnits\mynetwork\image.
   folder\username-dev-testing-rg.resourcegroup\username-dev-tsvda.vm).
   AdditionalData
2 Key Value
3 ServiceOfferingDescription Standard_B2ms
4 HardDiskSizeGB 127
5 ResourceGroupName FENGHUAJ-DEV-TESTING-RG
6 ServiceOfferingMemory 8192
7 ServiceOfferingCores 2
8 TemplateIsWindowsTemplate True
9 ServiceOfferingWithTemporaryDiskSizeInMb 16384
10 SupportedMachineGenerations Gen1,Gen2
11 <!--NeedCopy-->

```

Identify resources created by MCS

Following are the tags that MCS adds to the resources. The tags in the table are represented as “key” :”value”.

| Resource name | Tag |
|--------------------|---|
| ID disk | “CitrixProvisioningSchemeId”:
“xxxxxxxx-xxxx-xxxx-xxxx-xxxxxxxxxxxxxx”
“CitrixResource”: “Internal” |
| Image | “CitrixProvisioningSchemeId”:
“xxxxxxxx-xxxx-xxxx-xxxx-xxxxxxxxxxxxxx”
“CitrixResource”: “Internal” |
| NIC | “CitrixProvisioningSchemeId”:
“xxxxxxxx-xxxx-xxxx-xxxx-xxxxxxxxxxxxxx”
“CitrixResource”: “Internal” |
| OS disk | “CitrixProvisioningSchemeId”:
“xxxxxxxx-xxxx-xxxx-xxxx-xxxxxxxxxxxxxx”
“CitrixResource”: “Internal” |
| PrepVM | “CitrixProvisioningSchemeId”:
“xxxxxxxx-xxxx-xxxx-xxxx-xxxxxxxxxxxxxx”
“CitrixResource”: “Internal” |
| Published snapshot | “CitrixProvisioningSchemeId”:
“xxxxxxxx-xxxx-xxxx-xxxx-xxxxxxxxxxxxxx”
“CitrixResource”: “Internal” |

| Resource name | Tag |
|-----------------|--|
| Resource group | “CitrixResource”: “Internal”
CitrixSchemaVersion: 2.0 |
| Storage account | “CitrixProvisioningSchemeld”:
“XXXXXXXX-XXXX-XXXX-XXXX-XXXXXXXXXXXX”
“CitrixProvisioningSchemeld”:
“XXXXXXXX-XXXX-XXXX-XXXX-XXXXXXXXXXXX”
“CitrixResource”: “Internal” |
| VM in catalog | “CitrixProvisioningSchemeld”:
“XXXXXXXX-XXXX-XXXX-XXXX-XXXXXXXXXXXX”
“CitrixResource”: “Internal” |
| WBC disk | “CitrixProvisioningSchemeld”:
“XXXXXXXX-XXXX-XXXX-XXXX-XXXXXXXXXXXX”
“CitrixResource”: “Internal” |

Note:

A VM is not visible in the Citrix inventory if a **CitrixResource** tag is added to identify it as a resource created by MCS. You can remove or rename the tag to make it visible.

More information

- [Create and manage connections and resources](#)
- [Connection to Microsoft Azure](#)
- [Create machine catalogs](#)
- [Create a Microsoft Azure catalog](#)
- [Manage machine catalogs](#)

Manage a Microsoft System Center Virtual Machine Manager catalog

June 27, 2023

[Manage machine catalogs](#) describes the wizards that manage a machine catalog. The following information covers details specific to Microsoft System Center Virtual Machine Manager (VMM) virtualization environments.

Note:

Before managing a VMM catalog, you need to finish creating a VMM catalog. See [Create a Microsoft System Center Virtual Machine Manager catalog](#).

Identify resources created by MCS

Following are the tags that MCS adds to the resources. The tags in the table are represented as “key”:”value”.

| Resource name | Tag |
|---------------|---|
| Prep VM | Tag string: “CitrixProvisioningSchemeld”:
“xxxxxxxx-xxxx-xxxx-xxxx-xxxxxxxxxxxxx”
Custom property entry: “XdConfig:”
XdProvisioned=True” |
| VM in catalog | Tag string: “CitrixProvisioningSchemeld”:
“xxxxxxxx-xxxx-xxxx-xxxx-xxxxxxxxxxxxx”
Custom property entry: “XdConfig:”
XdProvisioned=True” |

More information

- [Create and manage connections and resources](#)
- [Connection to Microsoft System Center Virtual Machine Manager](#)
- [Create machine catalogs](#)
- [Create a Microsoft System Center Virtual Machine Manager catalog](#)
- [Manage machine catalogs](#)

Manage a VMware catalog

November 1, 2023

[Manage machine catalogs](#) describes the wizards that manage a machine catalog. The following information covers details specific to VMware virtualization environments.

Note:

Before managing a VMware catalog, you need to finish creating a VMware catalog. See [Create a](#)

VMware catalog.

Update the folder ID of a machine catalog

You can update the folder ID of an MCS machine catalog by specifying the `FolderId` in the custom properties of `Set-ProvScheme` command. The VMs created after updating the folder ID are created under this new folder ID. If this property is not specified in `CustomProperties`, then VMs are created under the folder where the master image is located.

Perform the following steps to update the folder ID of a machine catalog.

1. Open a Web browser and enter the URL for the **vSphere Web Client**.
2. Enter the credentials and click **Login**.
3. Create a VM placement folder in **vSphere Web Client**.
4. Open a PowerShell window.
5. Run **asnp citrix*** to load the Citrix-specific PowerShell modules.
6. Specify the `FolderID` in the `CustomProperties` of `Set-ProvScheme`. In this example, the folder ID value is `group-v2406`.

```
1 Set-ProvScheme -ProvisioningSchemeUid "50bb319c-2e83-4a37-9ea1-94
   f630687372" -CustomProperties "<CustomProperties xmlns=""http
   ://schemas.citrix.com/2014/xd/machinecreation"" xmlns:xsi=""
   http://www.w3.org/2001/XMLSchema-instance""><Property xsi:type=
   ""StringProperty"" Name=""FolderId"" Value=""group-v2406"" /></
   CustomProperties>"
2 <!--NeedCopy-->
```

7. Add a VM to the machine catalog using Studio.
8. Check the new VM on vSphere Web Client. The new VM is created under the new folder.

Find the folder ID in vSphere

Access Managed Object Browser (MOB) on any ESXi or vCenter server system to find the folder ID of the VMs.

The MOB is a web-based server application available inbuilt in all ESX/ESXi and vCenter server systems. This vSphere utility allows you to view detailed information about objects like VMs, datastores, and resource pools.

1. Open a web browser and enter `http://x.x.x.x/mob`, where x.x.x.x is the IP address of the vCenter Server or ESX/ESXi host. For example, `https://10.60.4.70/mob`.
2. On the **Home** page of MOB, click the value of the property **content**.

3. Click the value of the **rootFolder**.
4. Click the value of the **childEntity**.
5. Click the value of the **vmFolder**.
6. You can find the folder ID in the value of the **childEntity**.

Storage migration of VMs

You can move the disk storage of existing VMs from an old storage to a new storage. During migration, MCS retains the VM capabilities such as power management, reset OS disk, and so on. You can also add new VMs to the machine catalog using the new disk storage. To do this, use the PowerShell command `Move-ProvVMDisk`.

Currently, you can only migrate full clone persistent VMs.

The new storage must satisfy the following conditions:

- It must be within the same cluster of the old storage.
- The host on which the VM is running must have access to both the old and new datastores.

You can do the following tasks:

- Migrate the disk storage
- Deprecate the old storage

Migrate the disk storage

To migrate the disk storage:

1. Add a new storage to an existing hosting unit. Change the old storage to **Superseded**. You can do this using the Full Configuration interface or PowerShell commands.
 - If using the Full Configuration interface, see [Edit storage](#).
 - If using PowerShell commands:
 - Run `Add-Hyphostingunitstorage` to add the new storage to the existing hosting unit.
 - Run `Set-Hyphostingunitstorage` with **Superseded** as true to disable new VM creation in the old storage.
2. Turn off the VMs and turn on the **Maintenance Mode**.
3. Move disk storage of the VMs to the new storage and update the storage information. For example:

```

1 Move-ProvVMDisk -ProvisioningSchemeName xxxxx -VMName ("VMware-
  TestVM01", "VMware-TestVM02") -DestinationStorageId datastore
  -102
2 <!--NeedCopy-->

```

4. Get the task ID of the migration. For example:

```

1 ,(Get-ProvVM -ProvisioningSchemeName xxxxx) | Move-ProvVMDisk -
  ProvisioningSchemeName xxxxx -DestinationStorageId datastore
  -102
2 <!--NeedCopy-->

```

5. Check the status of the migration.

- `(Get-ProvTask -TaskID xxxxxxxxx).DiskMovedVirtualMachines`: Provides the list of VMs with successful disk migration, including the VMs that are already migrated to the new storage.
- `(Get-ProvTask -TaskID xxxxxxxxx).DiskMoveFailedVirtualMachines`: Provides the list of VMs with failed migration.
- `(Get-ProvTask -TaskID xxxxxxxxx).NotStartedVirtualMachines`: Provides the list of VMs whose migration has not yet started.
- `Get-ProvVM -ProvisioningSchemeName xxxxx -VMName "VMware-TestVM01"`: Provides the updated VM properties after the migration. Check the properties such as `StorageId`, `AssignedImage`, `BootedImage`, `IdentityDiskId`, `IdentityDiskStorage`, and `LastBootTime`.

After migrating the disks of MCS created VMs with snapshot, you might see the warning **Consolidation is required in the VSphere Client**. To consolidate and avoid data loss:

1. Take a VMware VM backup. For example, transfer all VM files into another folder on a datastore.
2. After you see the warning, click **Consolidate**, and then click **OK** to confirm the consolidation.

Deprecate the old storage

To deprecate the old storage after VMs disk migration:

1. Get the information about the base disks and machine count in each disk storage of the hosting unit. For example:

```

1 $result=Get-ProvSchemeResourceInStorage -ProvisioningSchemeName
  xxxxx
2 $result
3 $result.ProvResourceInStorage | Format-List -Property *
4 <!--NeedCopy-->

```

After a successful migration, MCS automatically removes the stale base disk and there are no machines in the old storage. Therefore, after running the command, make sure that there are no machines and base disk in the old storage.

2. Run `Remove-Hyphostingunitstorage` to entirely remove the old storage from the hosting unit. You can also use the Full Configuration interface to remove the old storage.

Identify resources created by MCS

Following are the tags that MCS adds to the resources. The tags in the table are represented as “key” :”value”.

| Resource name | Tag |
|---------------|--|
| Prep VM | “CitrixProvisioningSchemeld”:
“xxxxxxxx-xxxx-xxxx-xxxx-xxxxxxxxxxxxx”
“XdConfig:”XdProvisioned=True” |
| VM in catalog | “CitrixProvisioningSchemeld”:
“xxxxxxxx-xxxx-xxxx-xxxx-xxxxxxxxxxxxx”
“XdConfig:”XdProvisioned=True” |

More information

- [Create and manage connections and resources](#)
- [Connection to VMware](#)
- [Create machine catalogs](#)
- [Create a VMware catalog](#)
- [Manage machine catalogs](#)

Power Management

November 15, 2023

With Citrix Virtual Apps and Desktops, you can power manage MCS-provisioned VMs across various supported hypervisors and cloud services. The power management operation provides you:

- Optimal user experience
- Cost management and power savings

The power actions available are:

- Start
- Shut down
- Restart
- Suspend
- Resume
- Force restart
- Force shutdown

Note:

- For a non-persistent VM, power cycle (shutdown/start and restart) results in OS disk getting reset.
- Power action capabilities and behaviors vary depending on hypervisors or cloud services.

The article covers key power management features associated with certain supported hypervisors.

- [Power manage AWS VMs](#)
- [Power manage Azure VMs](#)

Power manage AWS VMs

November 9, 2023

For information on required permissions, see [Required AWS permissions](#).

Instance Hibernation

The hibernation process stores the in-memory state of the instance, along with its private, and elastic IP addresses, allowing it to pick up exactly where it left off.

When an instance is instructed to hibernate, it writes the in-memory state to a file in the root EBS volume, and then shuts itself down. An Amazon EBS volume is a durable, block-level storage device that you can attach to your instances. After you attach a volume to an instance, you can use it as you would use a physical hard drive. Encrypt the root EBS volume of the instance. The encryption ensures proper protection for sensitive data when it is copied from memory to the EBS volume. For information on EBS encryption, see [Amazon EBS encryption](#).

Following are the limitations of the supported instance hibernation:

- Instance memory (RAM) of only up to 150 GB is supported

- UEFI boot mode is not supported
- The General Purpose SSD and Provisioned IOPS SSD are only supported as EBS volume types.

Following is the host connection capability at the hypervisor level.

- Suspend-capable hypervisors: VMware, XenServer, Hyper-V, and GCP
- Not suspend-capable hypervisors: Nutanix, Azure, and AWS

Note:

- All suspend and hibernate capabilities are called suspend.
- For AWS, the suspend capability is supported at the machine level but not supported at the hypervisor level.

Create hibernation supported VMs

To create hibernation supported VMs:

1. Create a host connection. See [Connection to AWS](#).
2. Launch an instance with EBS root encrypted and the **Stop-Hibernate** property enabled. For more information on how to launch the instance, encrypt root EBS volume, and enable hibernation, see <https://docs.aws.amazon.com/AWSEC2/latest/UserGuide/launching-instance.html/>. Use this instance as a master image to create an AMI.
3. Prepare the master image:
 - a) Install a VDA on the master image. Citrix recommends installing the latest version to allow access to the newest features. Failure to install a VDA on the master image causes the catalog creation to fail. For more information on how to install a VDA, see [Install VDAs](#).
 - b) Join the master image to the domain where applications and desktops are members. Ensure that the master image is available on the host where the machines are created.
4. Create an AMI from that instance. For information on creating an AMI from an instance, see [Create an AMI from an Amazon EC2 Instance](#).
5. Create a machine catalog using `New-ProvScheme` command. Set the `AwsCaptureInstanceProperties` custom property as **True**. For information on enabling AWS instance properties in the Full configuration interface, see [Applying AWS instance properties and tagging operational resources in the Full Configuration interface](#).

```

1 New-ProvScheme -AdminAddress "xxx" -CleanOnBoot
2 -CustomProperties "AwsCaptureInstanceProperties,true;"
3 -HostingUnitName "xxx" -IdentityPoolName $catalog_name -
  InitialBatchSizeHint 1
4 -MasterImageVM "xyz.template" -NetworkMapping @{

```

```

5  "0"="XDHyp:\HostingUnits\MyConn\us-east-2a.availabilityzone
    \10.0.0.0` `/24 (vpc-0f1771e45671aedcd).network" }
6
7  -ProvisioningSchemeName $catalog_name
8  -RunAsynchronously -Scope @() -SecurityGroup @("xxx") -
    ServiceOffering "xxx"
9  <!--NeedCopy-->

```

For information on creating machine catalog using PowerShell commands, see <https://developer-docs.citrix.com/projects/citrix-daas-sdk/en/latest/>.

VMs that can be hibernated are created if:

- You select an AMI created from a master image that has the **Stop-Hibernate** property enabled.
- The master VM is domain joined and has the VDA installed.
- You select the correct VM size (service offering) that can handle hibernation.

The **New-ProvScheme** command fails with an appropriate error message if:

- The master VM is hibernation enabled but the service offering is not capable of handling hibernation.
- If the master VM is not domain joined and has no VDA installed.

Hibernation status of service offerings and AMI

To get the hibernation status of the service offerings and AMI (templates), run the following commands:

- `Get-HypConfigurationObjectForItem 'XDHyp:\HostingUnits\MyConn\WIN2016-ADDC-2021.09.10.145334-a1968709-10c4-47d5-9642-21e743159a7b(ami-0e6c5b33a52d2a6b6).template'`
- `Get-HypConfigurationObjectForItem 'XDHyp:\HostingUnits\MyConn\R6iSixteen Extra Large Instance.serviceoffering'`

Update service offering of an existing hibernation supported provisioning scheme

1. Run the `Set-ProvScheme` command. For example,

```

1  Set-ProvScheme -ProvisioningSchemeName <String> -ServiceOffering <
    String>
2  <!--NeedCopy-->

```

The system displays an exception message if the service offering is not compatible.

Update machine catalog that supports hibernation

If you try to update an existing machine catalog with a machine catalog that does not support hibernation, the update fails with an appropriate error message.

Power management of hibernated VMs

You can do the following power management operations on the hibernated VMs:

1. Suspend VM from the running state.
2. Resume VM from the suspended state.
3. Restart VM from the suspended state.

Power manage Azure VMs

April 4, 2024

For information on required permissions, see [Required Azure permissions](#).

Azure on-demand provisioning

With Azure on-demand provisioning, VMs are created only when Citrix Virtual Apps and Desktops initiates a power-on action, after the provisioning completes.

When you use MCS to create machine catalogs in the Azure Resource Manager, the Azure on-demand provisioning feature:

- Reduces your storage costs
- Provides faster catalog creation

When you create an MCS catalog, the Azure portal displays the network security groups, network interfaces, base images, and identity disks in the resource groups.

The Azure portal does not show a VM until Citrix Virtual Apps and Desktops initiates a power-on action for it. There are two types of machines with the following differences:

- For a pooled machine, the operating system disk and write-back cache exist only when the VM exists. When you shut down a pooled machine in the console, the VM isn't visible in the Azure portal. There's a significant storage cost saving if you routinely shut down machines (for example, outside of working hours).

- For a dedicated machine, the operating system disk is created the first time the VM is powered-on. The VM in the Azure portal remains in storage until the machine identity is deleted. When you shut down a dedicated machine in the console, the VM is still visible in the Azure portal.

Note:

Support for Azure catalogs created before on-demand provisioning feature (“legacy” catalogs) is deprecated. Therefore, recreate Azure legacy catalog VMs. The catalogs are then provisioned as on-demand that saves storage cost.

Preserve a provisioned virtual machine when power cycling

Choose whether to preserve a provisioned virtual machine when power cycling. Use the PowerShell parameter `New-ProvScheme CustomProperties`. This parameter supports an extra property, `PersistVm`, used to determine if a provisioned virtual machine persists when power cycled. Set the `PersistVm` property to **true** to persist a virtual machine when powered-off, or set the property to **false** to ensure that the virtual machine isn’t preserved when powered-off.

Note:

The `PersistVm` property only applies to a provisioning scheme with the properties `CleanOnBoot` and `UseWriteBackCache` enabled. If the `PersistVm` property isn’t specified for non-persistent virtual machines, they’re deleted from the Azure environment when powered-off.

In the following example, the `New-ProvScheme CustomProperties` parameter sets the `PersistVm` property to **true**:

```
1 <CustomProperties xmlns="http://schemas.citrix.com/2014/xd/
   machinecreation" xmlns:xsi="http://www.w3.org/2001/XMLSchema-
   instance">
2 <Property xsi:type="StringProperty" Name="UseManagedDisks" Value="true"
   />
3 <Property xsi:type="StringProperty" Name="StorageType" Value="
   Standard_LRS" />
4 <Property xsi:type="StringProperty" Name="PersistWBC" Value="false" />
5 <Property xsi:type="StringProperty" Name="PersistOsDisk" Value="true"
   />
6 <Property xsi:type="StringProperty" Name="PersistVm" Value="true" />
7 <Property xsi:type="StringProperty" Name="ResourceGroups" Value="demo-
   resourcegroup" />
8 <Property xsi:type="StringProperty" Name="LicenseType" Value="
   Windows_Client" />
9 </CustomProperties>
10 <!--NeedCopy-->
```

In the following example, the `New-ProvScheme CustomProperties` parameter preserves the write-back cache by setting `PersistVM` to **true**:

```

1  New-ProvScheme
2  -AzureAdJoinType "None"
3  -CleanOnBoot
4  -CustomProperties "<CustomProperties xmlns='http://schemas.citrix.com
    /2014/xd/machinecreation' xmlns:xsi='http://www.w3.org/2001/
    XMLSchema-instance'><Property xsi:type='StringProperty' Name='
    UseManagedDisks' Value='true' /><Property xsi:type='
    StringProperty' Name='StorageType' Value='Standard_LRS' /><
    Property xsi:type='StringProperty' Name='PersistWBC' Value='
    false' /><Property xsi:type='StringProperty' Name='
    PersistOsDisk' Value='true' /><Property xsi:type='
    StringProperty' Name='PersistVm' Value='true' /><Property xsi:
    type='StringProperty' Name='ResourceGroups' Value='demo-
    resourcegroup' /><Property xsi:type='StringProperty' Name='
    LicenseType' Value='Windows_Client' /></CustomProperties>"
5  -HostingUnitName "demo"
6  -IdentityPoolName "NonPersistent-MCSI0-PersistVM"
7  -MasterImageVM "XDHyp:\HostingUnits\demo\image.folder\scale-test.
    resourcegroup\demo-snapshot.snapshot"
8  -NetworkMapping @ {
9  "0"="XDHyp:\HostingUnits\demo\virtualprivatecloud.folder\East US.
    region\virtualprivatecloud.folder\ji-test.resourcegroup\jittest-vnet
    .virtualprivatecloud\default.network" }
10
11 -ProvisioningSchemeName "NonPersistent-MCSI0-PersistVM"
12 -ServiceOffering "XDHyp:\HostingUnits\demo\serviceoffering.folder\
    Standard_B2ms.serviceoffering" -UseWriteBackCache
13 -WriteBackCacheDiskSize 127
14 -WriteBackCacheMemorySize 256
15 <!--NeedCopy-->

```

Tip:

The `PersistVm` property determines whether to preserve a provisioned virtual machine. The `PersistOsdisk` property determines whether to persist the OS disk. To preserve a provisioned virtual machine, preserve the OS disk first. Do not delete the OS disk without first deleting the virtual machine. You can use the `PersistOsdisk` property without using specifying the `PersistVm` parameter.

Customize power on behavior at storage type change failure

At power-on, the storage type of a managed disk can fail to change to the desired type due to a failure on Azure. In these scenarios, the VM would remain off with a failure message sent to you. However, you can either choose to power on the VM even when storage can't be restored to its configured type or choose to keep the VM powered-off.

- If you configure the custom property `FailSafeStorageType` as **true** (default setting) or do not specify it in `New-ProvScheme` or `Set-ProvScheme` commands:
 - On power-on, the VM powers on with the incorrect storage type.
 - On shutdown, the VM remains off with the incorrect storage type.
- If you configure the custom property `FailSafeStorageType` as **false** in `New-ProvScheme` or `Set-ProvScheme` commands:
 - On power-on, the VM remains off with the incorrect storage type.
 - On shutdown, the VM remains off with the incorrect storage type.

To create a machine catalog:

1. Open a PowerShell window.
2. Run `asnp citrix*` to load the Citrix-specific PowerShell modules.
3. Create an identity pool if not already created.
4. Add the custom property in `New-ProvScheme`. For example:

```

1 New-ProvScheme -HostingUnitName "Azure-Resources-1" -
  IdentityPoolName "name" -InitialBatchSizeHint 1
2 -MasterImageVM "XDHyp:\HostingUnits\Azure-Resources-1\image.folder
  \abc.resourcegroup\def.snapshot"
3 -NetworkMapping @{
4   "0"="XDHyp:\HostingUnits\Azure-Resources-1\ght.folder\abc.
  resourcegroup\abc-vnet.virtualprivatecloud\default.network" }
5
6 -ProvisioningSchemeName "name"
7 -ServiceOffering "XDHyp:\HostingUnits\Azure-Resources-1\
  serviceoffering.folder\Standard_DS2_v2.serviceoffering"
8 -CustomProperties "<CustomProperties xmlns=`http://schemas.citrix
  .com/2014/xd/machinecreation`" xmlns:xsi=`http://www.w3.org
  /2001/XMLSchema-instance`">
9   <Property xsi:type=`"StringProperty`" Name=`"StorageType`" Value=`
  "Premium_LRS`" />
10  <Property xsi:type=`"StringProperty`" Name=`"StorageTypeAtShutdown
  `" Value=`"Standard_LRS`" />
11  <Property xsi:type=`"StringProperty`" Name=`"FailSafeStorageType`"
  Value=`"true`" />
12 </CustomProperties>"
13 <!--NeedCopy-->

```

5. Create the machine catalog. For information on how to create a catalog using the Remote PowerShell SDK, see <https://developer-docs.citrix.com/projects/citrix-virtual-apps-desktops-sdk/en/latest/creating-a-catalog/>.

To update an existing machine catalog so to include `FailSafeStorageType` custom property. This update does not affect existing VMs.

1. Update the custom property in `Set-ProvScheme` command. For example:

```

1 Set-ProvScheme -ProvisioningSchemeName <String> -CustomProperties "
2 <CustomProperties xmlns="http://schemas.citrix.com/2014/xd/
   machinecreation" xmlns:xsi="http://www.w3.org/2001/XMLSchema-
   instance">
3 <Property xsi:type="StringProperty" Name="StorageType" Value="
   Premium_LRS" />
4 <Property xsi:type="StringProperty" Name="IdentityDiskStorageType
   " Value="Premium_LRS" />
5 <Property xsi:type="StringProperty" Name="FailSafeStorageType"
   Value="false" />
6 </CustomProperties>"
7 <!--NeedCopy-->

```

To apply the change done in `Set-ProvScheme` to the existing VMs, run the `Set-ProvVMUpdateTimeWindow` command with `-StartsNow` and `-DurationInMinutes -1` parameters.

1. Run `Set-ProvVMUpdateTimeWindow` command with `-StartsNow` and `-DurationInMinutes -1` parameters command. For example:

```

1 Set-ProvVMUpdateTimeWindow -ProvisioningSchemeName my-catalog -
   VMName <List-Of-Vm-Names> -StartsNow -DurationInMinutes -1
2 <!--NeedCopy-->

```

2. Restart the VMs.

Create hibernation-capable VMs (Preview)

In Azure environments, you can create an MCS machine catalog that supports hibernation. Using this feature, you can suspend a VM, and then reconnect to the previous state of the VM when a user signs in again.

The hibernation capability applies to the following:

- Single-session OS
- Persistent and non-persistent VMs
- Static and random (pooled) VDI desktops

You can resume to the same session after you hibernate a VM, irrespective of whether the VDI desktop is static or random.

In this section, see the following:

- [Prerequisites](#)
- [Limitations](#)
- [Create and manage a hibernation-capable machine catalog](#)
- [Create a machine catalog for existing hibernation-capable VMs](#)

- [Enable hibernation on existing MCS-provisioned VMs](#)
- Check the hibernation property
- Power management of VMs (Manual and Automated)

Prerequisites to use hibernation

To use hibernation, make sure to complete the following tasks:

- Enable the feature for your Azure subscription. See [Enabling hibernation feature for your subscription](#).
- Install the Azure VM Agent on the master image for both Windows and Linux. The page file of the Windows image can be on the temporary disk. MCS sets the page file location to the C: drive in the base disk when hibernation is enabled on the machine catalog.
- MCS automatically sets the hibernation property for the generated resources. You do not need to configure properties of the master resources to support hibernation.
- Use a VM size in your subscription that supports hibernation.
- Create a hibernation-capable machine profile (VM or template spec) so that VMs inherit the hibernation-capability. To create the VM, see [Getting started with hibernation](#).

Note:

As per Microsoft, you can deploy hibernation enabled VMs from an OS disk. This feature is supported for certain regions currently and will be available for all the regions soon. For more information, see [Deploy hibernation enabled VMs from an OS disk](#).

To create the template spec, do the following:

1. Open the Azure Portal. Choose a VM whose configuration you want to use in the template. Select **Export template** in the left pane.
2. Clear the **Include parameters** checkbox. Copy the context and save it as a JSON file, for example, `VMExportTemplate.json`.
3. Ensure that the parameter `hibernationEnabled` is **true** on the template. If the parameter is not **true**, check the VM configuration that you used. You can specify a supported VM size in the template file. However, you can also specify the machine size while creating the catalog.
4. Add the template for the network interface resource to the JSON file `VMExportTemplate.json`. As a result, you have an ARM template file having two resources.
5. Select **Azure Portal > Template specs > Import template > Choose local template file** to import this template file as an ARM template spec.
6. After the ARM Template specification is created, you can use it as a machine profile.

Note:

It might take a few minutes to sync to Citrix Studio.

For more information, see the Microsoft document [Prerequisites to use hibernation](#).

Limitations

- Only single-session OS machine catalogs (persistent and non-persistent) are supported.
- Ephemeral OS disks and MCS I/O features do not support Azure hibernation.
- Hibernation might fail during the Automatic Windows updates.

For more information, see the [Microsoft document](#).

Create and manage a hibernation-capable machine catalog

To create hibernation-capable VMs, you can create and manage a hibernation-capable machine catalog using:

- Web Studio, or
- PowerShell commands

Create a catalog using Web Studio

1. Select **Create Machine Catalog**. The catalog creation wizard opens.
2. On the **Machine Type** page, select the **Single-session OS** machine type for this catalog.
3. On the **Machine Management** page, select the settings as follows:
 - a) Select **Machines that are power managed (for example, virtual machines or blade PCs)**.
 - b) Select **Citrix Machine Creation Services (MCS)**.
4. On the **Desktop Experience** page, select the random or static desktop experience as needed.
5. On the **Image** page, select a master image. Select the checkbox **Use a machine profile** and select a machine profile that supports hibernation. Click the tooltip to know if a machine profile supports hibernation.
6. On the **Storage and License Types** page, select the storage and license to use for this catalog.
7. On the **Virtual Machines** page, select the count of VMs, VM size, and availability zone.

Note:

The machine sizes that support hibernation are only shown for your selection.

8. On the **NICs** page, add the NICs you want the VMs to use.
9. On the **Disk Settings** page, select the storage type and size of the write-back cache disk.
10. On the **Resource Group** page, select the resource group to provision VMs.
11. On the **Machine Identities** page, select **Create new Active Directory accounts**. Then, specify an account naming scheme.
12. On the **Domain Credentials** page, click **Enter credentials**. Enter your domain credentials to perform account creation in the target Active Directory domain.
13. On the **Summary** page, enter a name for the machine catalog, and then click **Finish**.

When the MCS machine catalog creation is complete, locate the catalog in the catalog list, and then click the **Template Properties** tab. The value of the parameter **Hibernation** must be **Supported**.

If you want to edit a machine catalog, consider the following restrictions:

- If the current machine catalog supports hibernation, you can't:
 - Change the VM size to a hibernate-incapable one.
 - Change the machine profile to a hibernate-incapable one.
- If the current machine catalog does not support hibernation, you can't:
 - currently, change the machine profile to a hibernate-capable one using the Web Studio. However, you can do so using the PowerShell commands. See [Enable hibernation on existing MCS-provisioned VMs](#).

Create a machine catalog for managing existing hibernation-capable VMs If you already have hibernation-capable VMs and want to suspend and resume them, create a machine catalog to import those VMs for power management.

Note:

You can create a machine catalog containing both hibernation-capable and incapable VMs. However, if you want hibernation-related functionality, you must create the machine catalog with only hibernation-capable VMs.

To create a catalog for existing hibernation-capable VMs using Web Studio, follow the on-screen instructions to complete the steps and pay attention to the following key settings:

1. On the **Machine Management** page, select **Machines that are power managed**, and then select **Other service or technology** as the way of deploying machines.
2. On the **Virtual Machines** page, add or import only the hibernation-capable VMs.

Create a machine catalog using PowerShell commands After you meet all the requirements to use hibernation, you can create a hibernation-capable machine catalog using the `New-ProvScheme` command. For information on how to create a catalog using the Remote PowerShell SDK, see [New-ProvScheme](#).

While creating the catalog, you can check whether a VM size and machine profile supports hibernation or not using the following PowerShell commands:

- For the VM size, run the following command and check whether the property `supportsHibernation` is **True**. For example,

```
1 Get-ChildItem -AdminAddress "MyDDC.MyDomain.local" -LiteralPath @
  ("XDHyp:\HostingUnits\ <VirtualNetwork> \serviceoffering.
  folder") | select Name, AdditionalData | ConvertTo-Json
2 <!--NeedCopy-->
```

- For the machine profile, run the following command and check whether the property `supportsHibernation` is **True**. For example,

```
1 Get-ChildItem -AdminAddress "MyDDC.MyDomain.local" -LiteralPath @
  ("XDHyp:\HostingUnits\ <VirtualNetwork> \machineprofile.folder
  \abc.resourcegroup") | select Name, AdditionalData | ConvertTo-
  Json
2 <!--NeedCopy-->
```

If you want to edit a machine catalog, consider the following restrictions:

- If the current machine catalog supports hibernation, you can't:
 - Change the VM size to a hibernate-incapable one
 - Change the machine profile to a hibernate-incapable one
- If the current machine catalog does not support hibernation, you can't:
 - currently, change the machine profile to a hibernate-capable one using Web Studio. However, you can do so using the PowerShell commands. See [Enable hibernation on existing MCS-provisioned VMs](#).

For information on how to modify VM size and machine profile of a catalog using the Remote PowerShell SDK, see <https://developer-docs.citrix.com/projects/citrix-virtual-apps-desktops-sdk/en/latest/MachineCreation/Set-ProvScheme/>.

Enable hibernation on existing MCS-provisioned VMs

You can enable Azure hibernation on existing:

- Windows MCS-provisioned VMs of a machine catalog created without a temporary disk.
- Linux MCS-provisioned VMs of a machine catalog created with and without a temporary disk.

Note:

- The existing MCS-provisioned VMs must have an Azure VM agent installed.
- Currently, you can only use the PowerShell command to enable this feature.

To do this:

1. Open a **PowerShell** window.
2. Run `asnp citrix*` to load Citrix-specific PowerShell modules.
3. Check the configuration of the existing machines. For example:

```
1 Get-ProvScheme | select ProvisioningSchemeName,
   ProvisioningSchemeVersion
2 <!--NeedCopy-->
```

4. Enable hibernation on this machine catalog using the `Set-ProvScheme` command. For example:

```
1 Set-ProvScheme -provisioningSchemeName xxxx
2 -machineprofile <path-to-machineprofile-with-hibernation-enabled>
3 -serviceoffering "XDHyp:\HostingUnits\msc-dev\serviceoffering.
   folder\Standard_D4as_v5.serviceoffering"
4 <!--NeedCopy-->
```

5. Request update on existing VMs in a machine catalog.

```
1 Set-ProvVMUpdateTimeWindow -ProvisioningSchemeUid xxxx -VMName <
   String[]
2 <!--NeedCopy-->
```

6. Restart the VMs to trigger updates on the existing VMs. For example:

```
1 New-BrokerHostingPowerAction -machinename "<name>" -Action Restart
2 <!--NeedCopy-->
```

Check hibernation property

You can check the hibernation property of a machine catalog, VM, and a broker machine using the PowerShell commands:

- To check the hibernation property of a provisioning scheme, run the following PowerShell commands. The `HibernationEnabled` parameter must be `True`.

```
1 (Get-ProvScheme -provisioningSchemeName <YourSchemeName>).
   VMMetadata -join "" | ConvertFrom-Json | Select
   HibernationEnabled
2 <!--NeedCopy-->
```

- To check the hibernation property of a provisioning VM, run the following PowerShell commands. The `SupportsHibernation` parameter must be `True`.

```
1 (Get-ProvVM -VMName <YourVMName>).CustomVmData | ConvertFrom-Json
   | Select SupportsHibernation
2 <!--NeedCopy-->
```

- To check the hibernation capacity of a broker machine, run the following PowerShell commands. The **Suspend** and **Resume** power actions indicate hibernation capability.

```
1 (Get-BrokerMachine -MachineName <YourMachineName>).
   SupportedPowerActions
2 <!--NeedCopy-->
```

Power management of hibernation-capable VMs

You can perform the following power management operations on the hibernation-capable VMs:

- **Suspend** VM from the running state
- **Resume** VM from the suspended state
- **Force shut** down VM from a suspended state
- **Force restart** the VM from the suspended state

See the following for more information:

- Suspend
- Resume

Suspend You can suspend a VM using one of the following ways:

- **Manually** using Web Studio
- **Automatically** using the timeout policy: For more information, see [Miscellaneous settings](#).

To manually suspend a VM:

1. Right-click the VM, and select **Suspend**. Click **Yes** to confirm the action. The **Power State** changes from **Suspending** to **Suspended**.

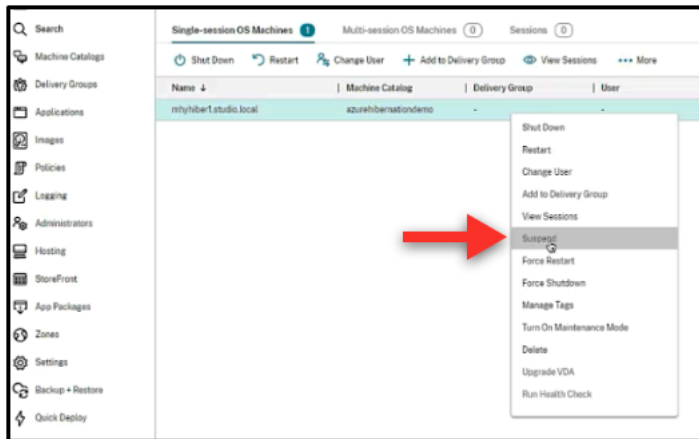

You can check the status of the VM in the Azure portal.

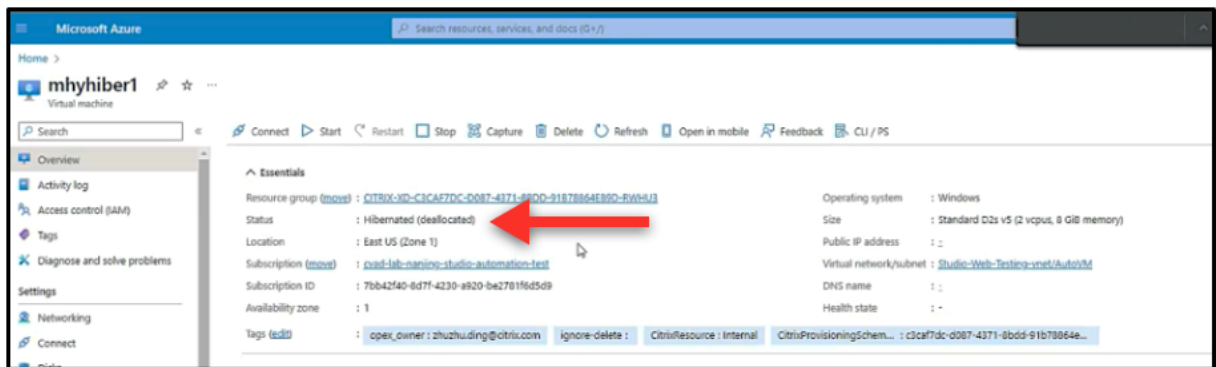

Resume To resume a hibernated VM, use one of the following ways:

- **Manually:**

- Administrators can resume the VM using the Web Studio.

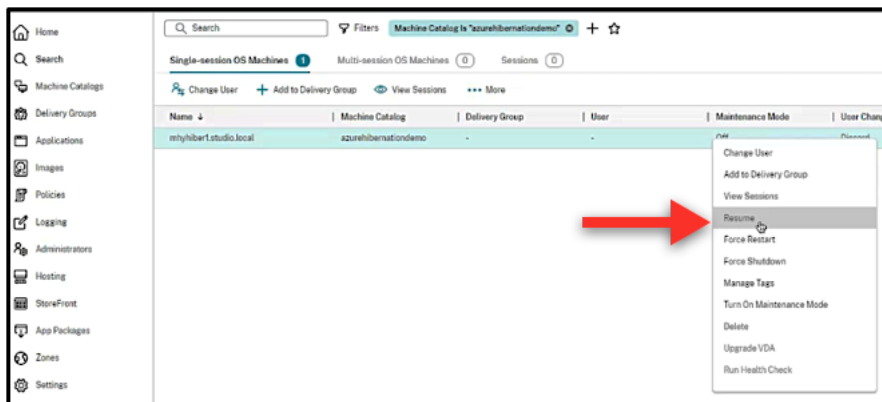

- End users can start the VM using the Citrix Workspace menu once they click the desktop icon.

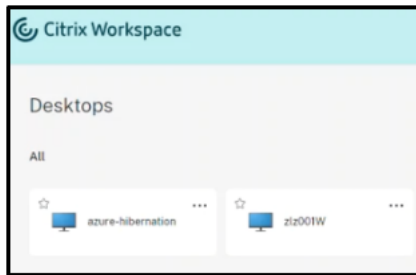

• **Automatically:**

- Autoscale can automatically power on the hibernated machines if you configure the peak times correctly. You can set the peak times in 30-minute intervals by clicking the time-schedule. Each blue frame represents a timeslot marked as peak time. The peak times can have consecutive and non-consecutive time slots.

★ Consecutive time slots

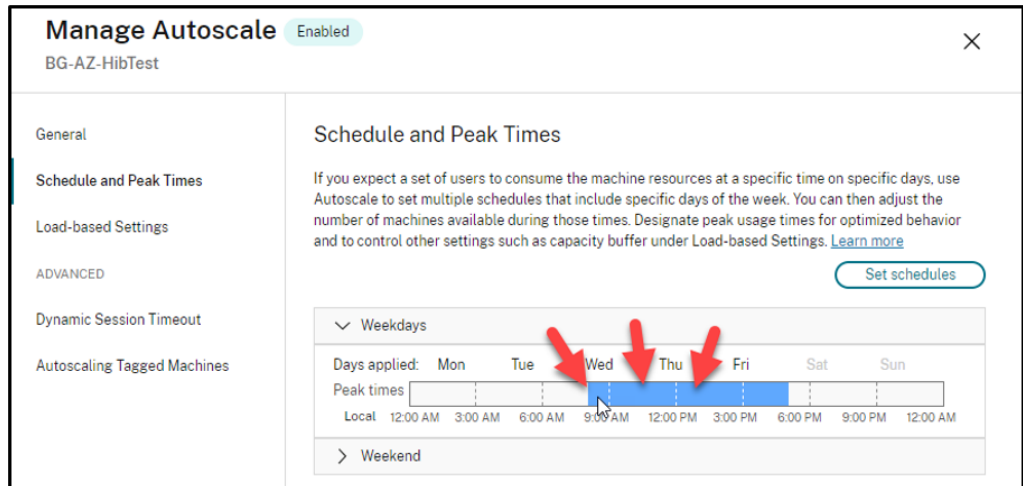

★ Non-consecutive time slots

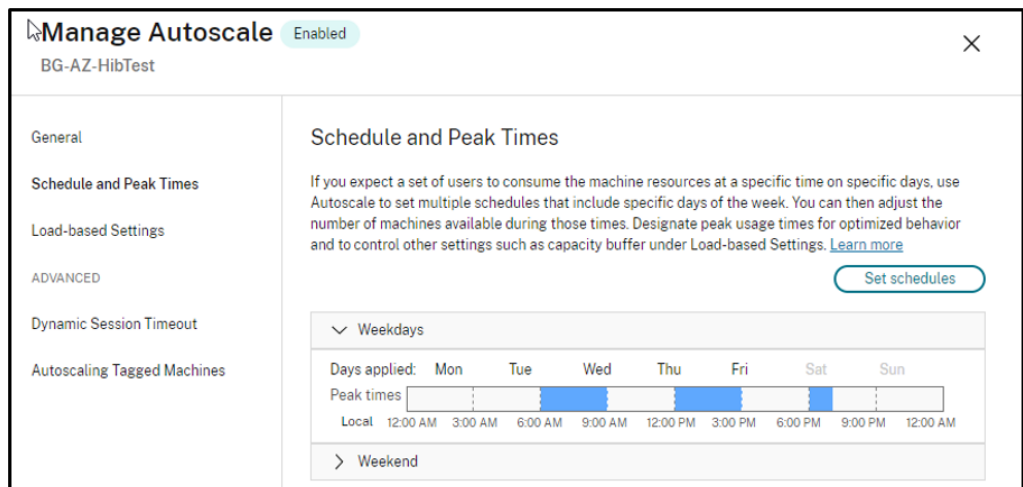

Note:

In **Manage Autoscale > Load-based Settings**, if the **Action** is configured as **Suspend**, then make sure that all VMs within that delivery group have hibernation capability. Otherwise, VMs that can't hibernate continues to run.

Manage Autoscale Enabled

BG-AZ-HibTest ✕

General

Schedule and Peak Times

Load-based Settings

ADVANCED

Dynamic Session Timeout

Autoscaling Tagged Machines

Load-based Settings

Capacity buffer

Capacity buffer is used to accommodate sudden spikes in demand by keeping a buffer of machines powered on based on the maximum load index of the delivery group. By default, the capacity buffer is 10% of the maximum supported load index of the delivery group. A lesser value decreases the cost. A greater value ensures an optimized user experience so that users do not have to wait for additional machines to power on when launching sessions. [Learn more](#)

| | | |
|----------------------|---|---|
| | During peak times | During off-peak times |
| Capacity buffer (%): | <input style="width: 60px; border: 1px solid #ccc;" type="text" value="0"/> | <input style="width: 60px; border: 1px solid #ccc;" type="text" value="0"/> |

Power policies

Configure policies for power managing machines in different scenarios. For each scenario, specify the waiting period (in minutes) and the action to take after the specified period elapses.

After disconnection

| | Waiting period (min) | Action |
|-----------------------|---|---|
| During peak times | <input style="width: 60px; border: 1px solid #ccc;" type="text" value="1"/> | <div style="display: flex; align-items: center; justify-content: center;"> ➔ <div style="border: 1px solid #ccc; padding: 2px 5px; border-radius: 3px;">Suspend</div> ▼ </div> |
| During off-peak times | <input style="width: 60px; border: 1px solid #ccc;" type="text" value="1"/> | <div style="display: flex; align-items: center; justify-content: center;"> ➔ <div style="border: 1px solid #ccc; padding: 2px 5px; border-radius: 3px;">Suspend</div> ▼ </div> |

After logoff

| | Waiting period (min) | Action |
|-----------------------|---|---|
| During peak times | <input style="width: 60px; border: 1px solid #ccc;" type="text" value="1"/> | <div style="border: 1px solid #ccc; padding: 2px 5px; border-radius: 3px;">Suspend</div> ▼ |
| During off-peak times | <input style="width: 60px; border: 1px solid #ccc;" type="text" value="1"/> | <div style="border: 1px solid #ccc; padding: 2px 5px; border-radius: 3px;">Suspend</div> ▼ |

If no user logs on after machine is powered on by Autoscale

| | Waiting period (min) | Action |
|-------------------|---|---|
| During peak times | <input style="width: 60px; border: 1px solid #ccc;" type="text" value="0"/> | <div style="border: 1px solid #ccc; padding: 2px 5px; border-radius: 3px;">No action</div> ▼ |

© 1999–2024 Cloud Software Group, Inc. All rights reserved.

562

More information

For more information on Citrix Azure hibernation, see the [Citrix Tech Zone article](#).

Security policies

July 7, 2023

This article describes security features on various supported cloud services. The security features include:

- [Security groups](#)
- [Secure boot](#)
- [Encryption capabilities](#)

Security groups

July 7, 2023

Security group is a group of security rules to filter network traffic between resources in a virtual network. The security rules allow or deny inbound network traffic to, or outbound network traffic from, several types of resources. Each rule specifies the following properties:

- **Name:** A unique name within the network security group
- **Priority:** Rules are processed in priority order, with lower numbers processed before higher numbers, because lower numbers have higher priority
- **Source or Destination:** Any, or an individual IP address, classless inter-domain routing (CIDR) block (10.0.0.0/24, for example), service tag, or application security group
- **Protocol:** The protocols based on which you add rules for each security group
- **Direction:** Whether the rule applies to inbound, or outbound traffic
- **Port range:** You can specify an individual or range of ports
- **Action:** Allow or deny

See the following for more information on supported hypervisors:

- [Security groups in AWS](#)
- [Security groups in Microsoft Azure](#)
- [Security groups in Google Cloud Platform](#)

Security groups in AWS

Security groups act as virtual firewalls that control traffic for the instances in your VPC. You add rules to your security groups that allow instances in your public subnet to communicate with instances in your private subnet. You can also associate these security groups with each instance in your VPC. Inbound rules control the incoming traffic to your instance, and outbound rules control the outgoing traffic from your instance.

For more information on the network setting during image preparation, see [Network setting during image preparation](#).

When you launch an instance, you can specify one or more security groups. To configure security groups, see [Configure security groups](#).

Security groups in Microsoft Azure

Citrix Virtual Apps and Desktops supports network security groups in Azure. Network security groups are expected to associate with subnets. For more information, see [Network security groups](#).

For more information on network security group created during image preparation, see [Create a machine catalog using an Azure Resource Manager image](#).

Security groups in Google Cloud Platform

During the preparation of a machine catalog, a machine image is prepared to serve as the master image system disk for the catalog. When this process occurs, the disk is temporarily attached to a virtual machine. This VM must run in an isolated environment that prevents all inbound and outbound network traffic. This is accomplished through a pair of deny-all firewall rules. For more information, see [Firewall Rules](#).

Secure boot

April 8, 2024

Secure boot is designed to ensure that only trusted software is used to boot the system. The firmware has a database of trusted certificates and verifies that the image it loads is signed by one of the trusted certificates. If that image loads further images, then that image must also be verified in the same way. vTPM is a virtualized software instance of a traditional physical TPM module. The vTPM enables attestation by measuring the entire boot chain of your VM (UEFI, OS, system, and drivers).

See the following for more information on supported cloud services:

- [Secure boot in Google Cloud Platform](#)
- [Secure boot in Microsoft Azure](#)
- [Secure boot in VMware](#)

Secure boot in Google Cloud Platform

You can provision shielded virtual machines on GCP. A shielded virtual machine is hardened using a set of security controls that provide verifiable integrity of your Compute Engine instances, using advanced platform security capabilities like secure boot, a virtual trusted platform module, UEFI firmware, and integrity monitoring.

For more information on using PowerShell to create a catalog with shielded VM, see [Using PowerShell to create a catalog with shielded VM](#).

Note:

If you install Windows 11 on the master image, then you must enable vTPM during the master image creation process. Also, you must enable vTPM on the machine profile source (VM or instance template). For information on creating Windows 11 VMs on the sole-tenant node, see [Create Windows 11 VMs on the sole-tenant node](#).

Secure boot in Microsoft Azure

In Azure environments, you can create machine catalogs enabled with Trusted launch. Azure offers trusted launch as a seamless way to improve the security of generation 2 VMs. Trusted launch protects against advanced and persistent attack techniques. At the root of trusted launch is secure boot for your VM. Trusted launch also uses the vTPM to perform remote attestation by the cloud. This is used for platform health checks and for making trust-based decisions. You can individually enable secure boot and vTPM. For more information on creating a machine catalog with Trusted launch, see [Machine catalogs with Trusted launch](#).

Secure boot in VMware

MCS supports creating a machine catalog with vTPM attached VMware template as a source for machine profile input. If windows 11 is installed on the master image, then it is a requirement to have vTPM enabled for the master image. Therefore, the VMware template, which is a source of machine profile, must have vTPM attached to it. For more information, see [Create a machine catalog using a machine profile](#).

Encryption capabilities

July 7, 2023

Encryption capabilities protect the content of virtual machines from attacks by malicious guests on a shared virtual machine host and from attacks launched by the hypervisor control software that manages all the virtual machines on the host.

See the following for more information on supported cloud services:

- [Encryption capabilities in AWS](#)
- [Encryption capabilities in Google Cloud Platform](#)
- [Encryption capabilities in Microsoft Azure](#)

Encryption capabilities in AWS

This section describes the encryption capabilities in AWS virtualization environments.

Automatic encryption

You can turn on automatic encryption of new Amazon EBS volumes and snapshot copies created in your account. For more information, see [Automatic encryption](#).

Encryption capabilities in Google Cloud Platform

This section describes the encryption capabilities in Google Cloud Platform (GCP) virtualization environments.

If you need more control over key operations than what Google-managed encryption keys allows, you can use customer-managed encryption keys. When using a customer-managed encryption key, an object is encrypted with the key by Cloud Storage at the time it's stored in a bucket, and the object is automatically decrypted by Cloud Storage when the object is served to requesters. For more information, see [Customer-managed encryption keys](#).

You can use Customer Managed Encryption Keys (CMEK) for MCS catalogs. For more information, see [Using Customer Managed Encryption Keys \(CMEK\)](#).

Encryption capabilities in Microsoft Azure

This section describes the encryption capabilities in Azure virtualization environments.

Azure server side encryption

Most Azure managed disks are encrypted with Azure Storage encryption, which uses server-side encryption (SSE) to protect your data and to help you meet your security and compliance commitments. Citrix Virtual Apps and Desktops supports customer-managed encryption keys for Azure managed disks through Azure Key Vault. For more information, see [Azure server side encryption](#).

Azure double encryption

Double encryption is platform-side encryption (default) and customer managed encryption (CMEK). Therefore, if you are a high security sensitive customer who is concerned about the risk associated with any encryption algorithm, implementation, or a compromised key, you can opt for this double encryption. Persistent OS and data disks, snapshots, and images are all encrypted at rest with double encryption. For more information, see [Double encryption on managed disk](#).

Create delivery groups

February 22, 2024

Note:

You can manage your Citrix Virtual Apps and Desktops deployment using two management consoles: Web Studio (web-based) and Citrix Studio (Windows-based). This article covers only Web Studio. For information about Citrix Studio, see the equivalent article in Citrix Virtual Apps and Desktops 7 2212 or earlier.

A delivery group is a collection of machines selected from one or more machine catalogs. The delivery group specifies which users can use those machines, plus the applications and desktops available to those users.

Creating a delivery group is the next step in configuring your deployment after creating a site and creating a machine catalog. Later, you can change the initial settings in the first delivery group and create other delivery groups. There are also features and settings that you can configure only when editing a delivery group, not when creating it.

For Remote PC Access, when you create a site, a delivery group named “Remote PC Access Desktops” is automatically created.

To create a delivery group:

1. If you have created a site and a machine catalog without a delivery group, Web Studio guides you to the correct starting place to create one.

2. If you have already created a delivery group and want to create another, follow these steps:
 - a) Select **Delivery Groups**. Select **Create Delivery Group** in the action pane.
 - b) To organize delivery groups using folders, create folders under the default **Delivery Groups** folder. For more information, see [Create a folder](#).
 - c) Select the folder where you want to create the group, and then click **Create Delivery Group**. The group creation wizard opens.
3. The wizard launches with an **Introduction** page, which you can remove from future launches of this wizard.
4. The wizard then guides you through the pages described in the following section. When you are done with each page, click **Next** until you reach the final page.

Step 1. Machines

On the **Machines** page, select a catalog and select the number of machines you want to use from that catalog.

Good to know:

- At least one machine must remain unused in a selected catalog.
- A catalog can be specified in more than one delivery group. A machine can be used in only one delivery group.
- A delivery group can use machines from more than one catalog; however, those catalogs must contain the same machine types (multi-session OS, single-session OS, or Remote PC Access). In other words, you cannot mix machine types in a delivery group. Similarly, if your deployment has catalogs of Windows machines and catalogs of Linux machines, a delivery group can contain machines from either OS type, but not both.
- Citrix recommends that you install or upgrade all machines with the most recent VDA version. Upgrade catalogs and delivery groups as needed. When creating a delivery group, if you select machines that have different VDA versions installed, the delivery group is compatible with the earliest VDA version. This is called the group's *functional level*. For example, if one of the machines has VDA version 7.1 and the other machines have the current version, all machines in the group can use only those features that were supported in VDA 7.1. This means that some features that require later VDA versions might not be available in that delivery group.
- Each machine in a Remote PC Access catalog is automatically associated with a delivery group. When you create a Remote PC Access site, a catalog named "Remote PC Access Machines" and a delivery group named "Remote PC Access Desktops" are created automatically.
- The following compatibility checks are performed:
 - MinimumFunctionalLevel must be compatible
 - SessionSupport must be compatible

- AllocationType must be compatible for SingleSession
- ProvisioningType must be compatible
- PersistChanges must be compatible for MCS and Citrix Provisioning
- RemotePC catalog is only compatible with Remote PC Access catalog
- AppDisk related check

Step 2. Load balancing

To configure the load balancing settings while creating a delivery group:

1. Sign in to Web Studio.
2. In the left-navigation, click **Delivery Groups**.
3. In the **Delivery Groups** page, click **Create Delivery Group**.
4. In the **Create Delivery Group** wizard, click **Next**. The **Machine** wizard opens.
5. In the **Machines** wizard, select a required machine catalog and click **Next**. The **Load Balancing** wizard opens.
6. In the **Load Balancing** wizard, select the **Override site-wide setting** checkbox.
7. Select either **Horizontal load balancing** or **Vertical load balancing** option as required and click **Next**.

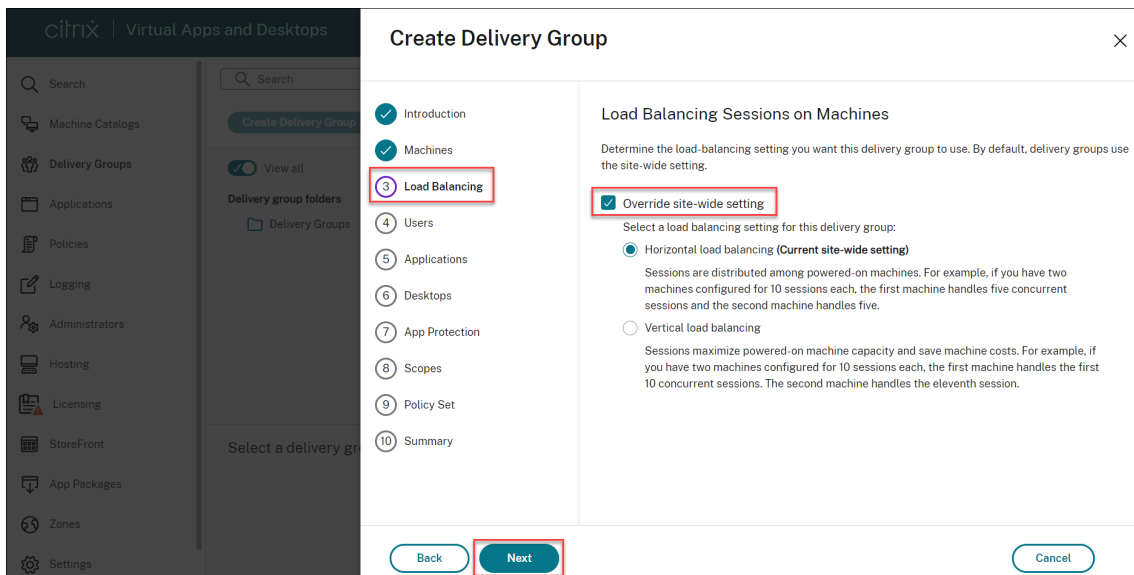

To configure the load balancing settings while editing an existing delivery group:

1. Sign in to Web Studio.
2. In the left-navigation, click **Delivery Groups**.

3. Select a **Delivery Group** from the list and click **Edit**. The **Edit Delivery Group** wizard opens.
4. In the **Edit Delivery Group** page, click **Load Balancing**.
5. Select the **Override site-wide setting** checkbox.
6. Select either **Horizontal load balancing** or **Vertical load balancing** option as required and click **Save**.

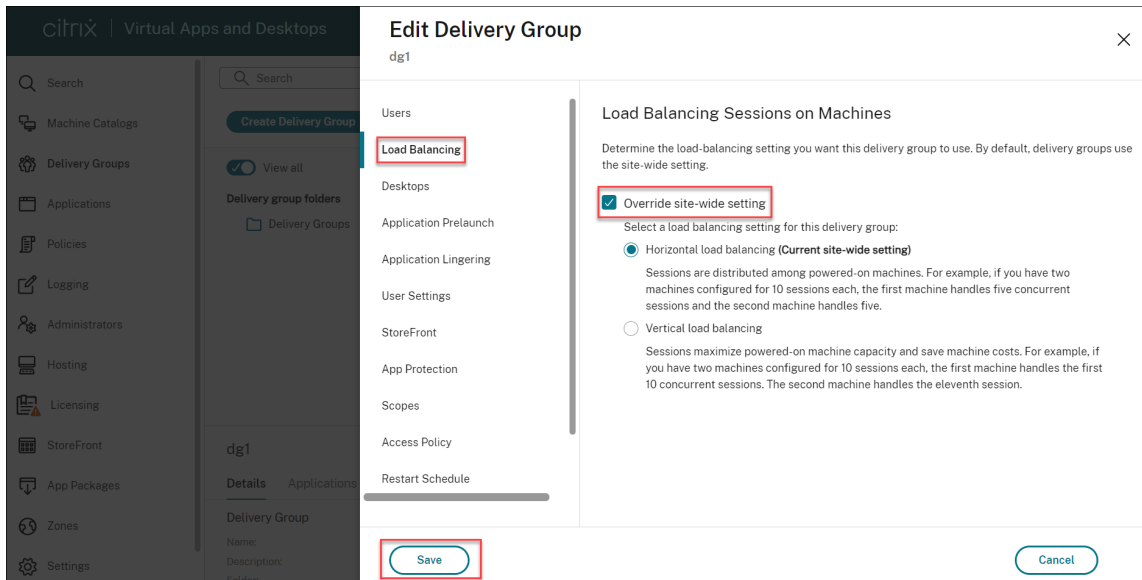

Note:

When Vertical load balancing setting is applied, make sure that the **Concurrent logon tolerance** and **Maximum number of sessions** policies are configured appropriately.

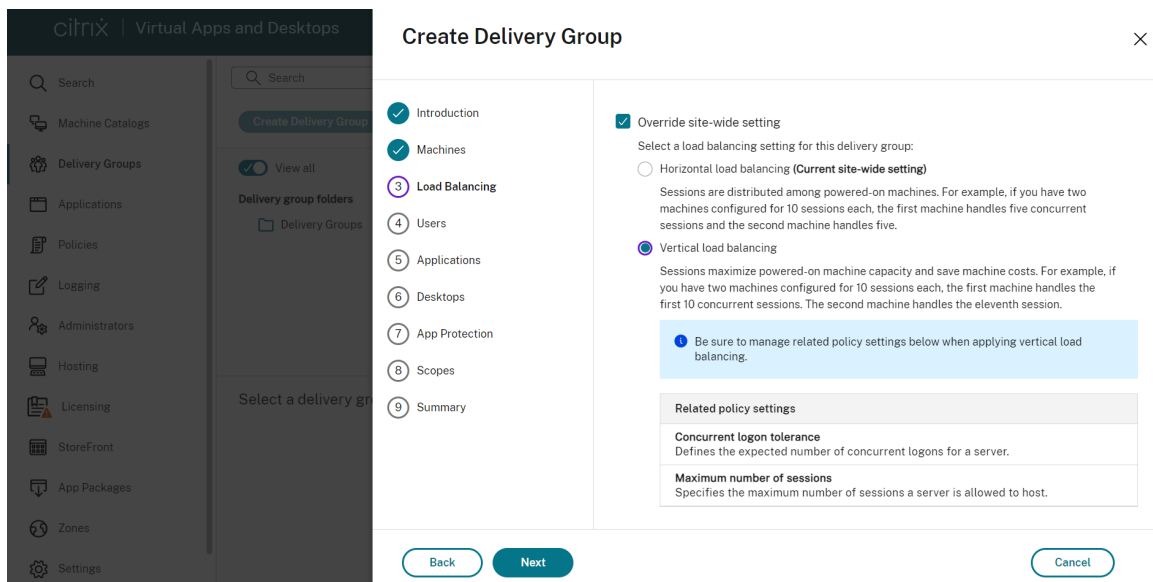

For more information about load balancing at site and delivery group level, see [Load balance machines](#)

Step 3. Delivery type

This page appears only if you chose a catalog containing static (assigned) single-session OS machines.

On the **Delivery Type** page, choose either **Applications** or **Desktops**. You cannot enable both.

If you selected machines from a multi-session OS or single-session OS random (pooled) catalog, the delivery type is assumed to be applications and desktops: you can deliver applications, desktops, or both.

Step 4. Users

Specify the users and user groups who can use the applications and desktops in the delivery group.

Where user lists are specified

Active Directory user lists are specified when you create or edit the following:

- A site's user access list, which is not configured through Web Studio. By default, the application entitlement policy rules includes everyone. See the PowerShell SDK [BrokerAppEntitlementPolicyRule](#) cmdlets for details.
- Application groups (if configured).
- Delivery groups.
- Applications.

The list of users who can access an application through StoreFront is formed by the intersection of the above user lists. For example, to configure the use of application A to a particular department, without unduly restricting access to other groups:

- Use the default application entitlement policy rule that includes everyone.
- Configure the delivery group user list to allow all headquarters users to use any of the applications specified in the delivery group.
- (If application groups are configured) Configure the application group user list to allow members of the Administration and Finance business unit to access applications A through L.
- Configure application A's properties to restrict its visibility to only Accounts Receivable staff in Administration and Finance.

Authenticated and unauthenticated users

There are two types of users: authenticated and unauthenticated (unauthenticated is also called anonymous). You can configure one or both types in a delivery group.

- **Authenticated:** To access applications and desktops, the users and group members you specify by name must present credentials such as smart card or user name and password to StoreFront or Citrix Workspace app. For delivery groups containing single-session OS machines, you can import user data (a list of users) later by editing the delivery group.
- **Unauthenticated (anonymous):** For delivery groups containing multi-session OS machines, you can allow users to access applications and desktops without presenting credentials to StoreFront or Citrix Workspace app. For example, at kiosks, the application might require credentials, but the Citrix access portal and tools do not. An Anonymous Users Group is created when you install the first Delivery Controller.

To grant access to unauthenticated users, each machine in the delivery group must have a VDA for Windows Server OS (minimum version 7.6) installed. When unauthenticated users are enabled, you must have an unauthenticated StoreFront store.

Unauthenticated user accounts are created on demand when a session is launched, and are named AnonXYZ, in which XYZ is a unique three-digit value.

Unauthenticated user sessions have a default idle timeout of 10 minutes, and are logged off automatically when the client disconnects. Reconnection, roaming between clients, and Workspace Control are not supported.

The following table describes your choices on the **Users** page:

| Enable access for | Add/assign users and user groups? | Enable the “Give access to unauthenticated users” checkbox? |
|--|-----------------------------------|---|
| Only authenticated users | Yes | No |
| Only unauthenticated users | No | Yes |
| Both authenticated and unauthenticated users | Yes | Yes |

Step 5. Applications

Good to know:

- You cannot add applications to Remote PC Access delivery groups.
- By default, new applications you add are placed in a folder named Applications. You can specify a different folder. For details, see the Manage Applications article.
- You can change the properties for an application when you add it to a delivery group, or later. For details, see the Manage Applications article.

- If you try to add an application and one with the same name exists in that folder, you are prompted to rename the application you are adding. If you decline, the application is added with a suffix that makes it unique within that application folder.
- When you add an application to more than one delivery group, a visibility issue can occur if you do not have sufficient permission to view the application in all of those delivery groups. In such cases, either consult an administrator with greater permissions or have your scope extended to include all the delivery groups to which the application was added.
- If you publish two applications with the same name to the same users, change the Application name (for user) property in Web Studio; otherwise, users see duplicate names in Citrix Workspace app.

Click **Add** to display the application sources.

- **From Start menu:** Applications that are discovered on a machine created from the master image in the selected catalog. When you select this source, a new page launches with a list of discovered applications; select those you want to add and then click **OK**.
- **Manually:** Applications located on a VDA in the delivery group or elsewhere in your network. Selecting this source opens a new page where you specify an application to add in the following ways:
 - Type the path to the executable, working directory, optional command line arguments, and display names for administrators and users.
 - Select an application from a VDA in the delivery group. To do so, click **Browse**, enter credentials for accessing the VDA, wait to be connected to the VDA, and then select an application from the VDA. The properties of the selected application automatically populate fields on the page.
- **Existing:** Applications previously added to the site, perhaps in another delivery group. When you select this source, a new page launches with a list of discovered applications. Add the applications and click **OK**.
- **App-V:** Applications in App-V packages. When you select this source, a new page launches where you select the App-V server or the Application Library. Select the applications you want to add from the resulting display and then click **OK**. For more information, see [Deploy and deliver App-V applications](#).

If an application source or application is not available or valid, it is either not visible or cannot be selected. For example, the **Existing** source is not available if no applications have been added to the site. Or, an application might not be compatible with the supported session types on machines in the selected catalog.

Step 6. Desktops

The title of this page depends on the catalog you chose on the **Machines** page:

- If you chose a catalog containing pooled machines, this page is titled **Desktops**.
- If you chose a catalog containing assigned machines and specified “Desktops” on the **Delivery Type** page, this page is titled **Desktop User Assignments**.
- If you chose a catalog containing assigned machines and specified “Applications” on the **Delivery Type** page, this page is titled **Application Machine User Assignments**.

Click **Add**. In the dialog box:

- In the Display name and Description fields, type the information to be displayed in Citrix Workspace app.
- To add a tag restriction to a desktop, select **Restrict launches to machines with this tag** and then select the tag from the drop-down list. For more information, see [Tags](#).
- Use the radio buttons to launch a desktop or to assign a machine when launching the desktop. The users can be either everyone who can access this delivery group, or specific users and user groups.
- If the group contains assigned machines, specify the maximum number of desktops per user. This must be a value of one or greater.
- Enable or disable the desktop (for pooled machines) or desktop assignment rule (for assigned machines). Disabling a desktop stops desktop delivery. Disabling a desktop assignment rule stops desktop auto-assignment to users.
- When you are finished with the dialog box, click **OK**.

Maximum instances of a desktop in a site (PowerShell only)

To configure the maximum instances of a desktop in the site (PowerShell only):

- In PowerShell, use the appropriate `BrokerEntitlementPolicyRule` cmdlet with the `MaxPerEntitlementInstances` parameter. For example, the following cmdlet modifies the `tsvda-desktop` rule to set the maximum concurrent instances of a desktop allowed in the site to two. When there are two desktop instances running, an error occurs if a third subscriber attempts to start a desktop.

```
Set-BrokerEntitlementPolicyRule -Name tsvda-desktop -MaxPerEntitlementInstances 2
```

- For guidance, use the `Get-Help` cmdlet. For example, `Get-Help Set-BrokerEntitlementPolicyRule -Parameter MaxPerEntitlementInstances`.

Step 7. Summary

Enter a name for the delivery group. You can also (optionally) enter a description, which appears in the Citrix Workspace app and in Web Studio.

Review the summary information and then click **Finish**.

Manage delivery groups

January 26, 2024

Note:

You can manage your Citrix Virtual Apps and Desktops deployment using two management consoles: Web Studio (web-based) and Citrix Studio (Windows-based). This article covers only Web Studio. For information about Citrix Studio, see the equivalent article in Citrix Virtual Apps and Desktops 7 2212 or earlier.

Introduction

This article describes procedures for managing delivery groups from the management console. In addition to changing settings specified when creating the group, you can configure other settings that are not available when you create a delivery group.

Procedure categories include: general, users, machines, and sessions. Some tasks span more than one category. For example, “Prevent users from connecting to machines” is described in the machines category, but it also affects users. If you can’t find a task in one category, check a related category.

Other articles also contain related information:

- [Applications](#) contain information about managing applications in delivery groups.
- Managing delivery groups requires the Delivery Group Administrator built-in role permissions. For details, see [Delegated administration](#).

General

- Change the delivery type
- Change StoreFront addresses
- Change the functional level
- Manage Remote PC Access delivery groups
- Organize delivery groups using folders

- Manage App Protection

Change the delivery type of a delivery group

The delivery type indicates what the group can deliver: applications, desktops, or both.

Before changing an **application only** or **desktops and applications** type to the **desktops only** type, delete all applications from the group.

1. Select **Delivery Groups** in the left pane.
2. Select a group and then click **Edit** in the action bar.
3. On the **Delivery Type** page, select the delivery type you want.
4. Click **Apply** to apply any changes you made and keep the window open. Or, click **Save** to apply changes and close the window.

Change StoreFront addresses

1. Select **Delivery Groups** in the left pane.
2. Select a group and then click **Edit** in the action bar.
3. On the **StoreFront** page, select or add StoreFront URLs. These URLs are used by the Citrix Workspace app, which is installed on each machine in the delivery group.
4. Click **Apply** to apply any changes you made and keep the window open. Or, click **Save** to apply changes and close the window.

You can also specify StoreFront server addresses by selecting **StoreFront** in the left pane.

Change the functional level

Change the functional level for the delivery group after you upgrade the VDAs on its machines and the machine catalogs containing the machines used in the delivery group.

Before you start:

- If you use Citrix Provisioning (formerly Provisioning Services), upgrade the VDA version in the Citrix Provisioning console.
- Start the machines containing the upgraded VDA so that they can register with a Delivery Controller. This process tells the console about what needs upgrading in the delivery group.
- If you must continue to use earlier VDA versions, newer product features are not available. For more information, see the upgrade documentation.

To upgrade a delivery group:

1. Select **Delivery Groups** in the left pane.

2. Select a group and then click **Upgrade Delivery Group** in the action bar. The **UChange Functional Level** action appears only if upgraded VDAs are detected.

The display indicates you which, if any, machines cannot be changed to the functional level and why. You can then cancel the change action, resolve the machine issues, and then perform the change action again.

After the change completes, you can revert the machines to their previous states. Select the delivery group and then select **Undo Functional Level Change** in the action bar.

Manage Remote PC Access delivery groups

If a machine in a Remote PC Access machine catalog is not assigned, the machine is temporarily assigned to a delivery group associated with that catalog. This temporary assignment enables the machine to be assigned to a user later.

The delivery group-to-machine catalog association has a priority value. Priority determines the machine's assigned delivery group when it registers with the system or when a user needs a machine assignment. The lower the value, the higher the priority. If a Remote PC Access machine catalog has multiple delivery group assignments, the software selects the match with the highest priority. Use the PowerShell SDK to set this priority value.

When first created, Remote PC Access machine catalogs are associated with a delivery group. Machine accounts or Organizational Units added to the catalog later can be added to the delivery group. This association can be switched off or on.

To add or remove a Remote PC Access machine catalog association with a delivery group:

1. Select **Delivery Groups** in the left pane.
2. Select a Remote PC Access group.
3. In the **Details** section, click the **Machine Catalogs** tab and then select a Remote PC Access catalog.
4. To add or restore an association, click **Add Desktops**. To remove an association, click **Remove Association**.

Organize delivery groups using folders

You can create folders to organize delivery groups for easy access.

Required roles By default, you need to have the following built-in role to create and manage delivery group folders: Cloud Administrator, Full Administrator, or Delivery Group Administrator. If necessary, you can customize roles for creating and managing delivery group folders. For more information, see Required permissions.

Create a delivery group folder Before you start, plan how to organize your delivery groups. Consider the following:

- You can nest folders up to five levels (excluding the default root folder).
- A folder can contain delivery groups and subfolders.
- All nodes (such as the **Machine Catalogs**, **Applications**, and **Delivery groups** nodes) share a folder tree in the back end. To avoid name conflicts with other nodes when renaming or moving folders, we recommend you give different names to first-level folders in different nodes.

To create a delivery group folder, follow these steps:

1. Select **Delivery Groups** in the left pane.
2. In the folder hierarchy, select a folder and then select **Create Folder** in the **Action** bar.
3. Enter a name for the new folder, and then click **Done**.

Tip:

If you create a folder in an unintended location, you can drag it to the correct location.

Move a delivery group

You can move a delivery group between folders. Detailed steps are as follows:

1. Select **Delivery Groups** in the left pane.
2. View groups by folder. You can also turn on **View all** above the folder hierarchy to view all groups at a time.
3. Right-click a group and then select **Move Delivery Group**.
4. Select the folder to which you want to move the group, and then click **Done**.

Tip:

You can drag a group to a folder.

Manage delivery group folders

You can delete, rename, and move delivery group folders.

Be aware that you can delete a folder only if it and its subfolders don't contain delivery groups.

To manage a folder, follow these steps:

1. Select **Delivery Groups** in the left pane.
2. In the folder hierarchy, select a folder, and then select an action in the **Action** bar as needed:

- To rename the folder, select **Rename Folder**.
- To delete the folder, select **Delete Folder**.
- To move the folder, select **Move Folder**.

3. Follow onscreen instructions to complete the remaining steps.

Required permissions The following table lists the permissions required to perform actions on delivery group folders.

| Action | Required permissions |
|---------------------------------|---|
| Create delivery group folders | Create Delivery Group Folder |
| Delete delivery group folders | Remove Delivery Group Folder |
| Move delivery group folders | Move Delivery Group Folder |
| Rename delivery group folders | Edit Delivery Group Folder |
| Move delivery groups to folders | Edit Delivery Group Folder and Edit Delivery Group Properties |

Manage App Protection

The following information is supplemental to [App protection](#). Mind the following details:

- You must have a valid App Protection entitlement. To purchase the App Protection feature, contact your Citrix sales representative.
- App Protection requires XML trust. To enable XML trust, go to **Settings > Enable XML trust**.
- Regarding anti-screen-capturing:
 - On Windows and macOS, only the window of the protected content is blank. App Protection is active when a protected window is not minimized.
 - On Linux, the entire capture is blank. App Protection is active whether a protected window is minimized or not.

To choose an App Protection method for a delivery group, follow these steps:

1. Select **Delivery Groups** in the left pane.
2. Select a group and then select **Edit** in the action bar.
3. On the **App Protection** page, you can enable **Anti-keylogging** and **Anti-screen-capturing**.

Users

- Change user settings
- Add or remove users

Change user settings in a delivery group

The name of this page appears as either **User Settings** or **Basic Settings**.

1. Select **Delivery Groups** in the left pane.
2. Select a group and then click **Edit** in the action bar.
3. On the **User Settings** (or **Basic Settings**) page, change any of the settings in the following table.
4. Click **Apply** to apply any changes you made and keep the window open. Or, click **Save** to apply changes and close the window.

| Setting | Description |
|-----------------------|--|
| Description | The text that Citrix Workspace (or StoreFront) uses and that users see. |
| Enable delivery group | Whether the delivery group is enabled. |
| Time zone | The time zone in which the machines of this delivery group must reside. The option lists the time zones supported by the site. Note: Changing the time zone on a delivery group might reboot the machines in that delivery group. To avoid this, ensure to change the time zone settings outside of production hours. |
| Enable Secure ICA | Secures communications to and from machines in the delivery group using SecureICA, which encrypts the ICA protocol. The default level is 128-bit. The level can be changed using the SDK. Citrix recommends using more encryption methods such as TLS encryption when traversing public networks. Also, SecureICA does not check data integrity. |

Add or remove users in a delivery group

For detailed information about users, see [Users](#).

1. Select **Delivery Groups** in the left pane.
2. Select a group and then click **Edit** in the action bar.
3. On the **Users** page:
 - To add users, click **Add**, and then specify the users you want to add.
 - To remove users, select one or more users and then click **Remove**.
 - Select or clear the check box to allow access by unauthenticated users.
4. Click **Apply** to apply any changes you made and keep the window open. Or, click **Save** to apply changes and close the window.

Import or export user lists For delivery groups containing physical single-session OS machines, you can import user information from a .csv file after you create the delivery group. You can also export user information to a .csv file. The .csv file can contain data from a previous product version.

The first line in the CSV file must contain two column headers, separated by a comma. Make sure that the first header is **Machine Account** and the second header is **User Names**. (You can include additional headers but they are not supported.) Subsequent lines in the file contain comma-separated data. The **Machine Account** entries can be computer SID, FQDN, or domain and computer name pairs.

To import or export user information:

1. Select **Delivery Groups** in the left pane.
2. Select a group and then click **Edit** in the action bar.
3. On the **Machine Allocation** page, select **Import** list or **Export** list, and then browse to the file location.
4. Click **Apply** to apply any changes you made and keep the window open. Or, click **Save** to apply changes and close the window.

Machines

- Change assignments of machines to users
- Change the maximum number of machines per user
- Update a machine
- Add, change, or remove a tag restriction for a desktop
- Remove a machine
- Restrict access to machines
- Prevent users from connecting to a machine (maintenance mode)
- Shut down and restart machines
- Create and manage restart schedules for machines

- Load managed machines
- Power managed machines

Change assignments of machines to users in a delivery group

You can change the assignments of single-session OS machines provisioned with MCS. You cannot change assignments for multi-session OS machines or machines provisioned with Citrix Provisioning.

1. Select **Delivery Groups** in the left pane.
2. Select a group and then click **Edit** in the action bar.
3. On the **Desktops** or **Desktop Assignment Rules** page (the page title depends on the type of machine catalog that the delivery group uses), specify the new users.
4. Click **Apply** to apply any changes you made and keep the window open. Or, click **Save** to apply changes and close the window.

Change the maximum number of machines per user in a delivery group

1. Select **Delivery Groups** in the left pane.
2. Select a group and then click **Edit** in the action bar.
3. On the **Desktop Assignment Rules** page, set the maximum desktops per user value.
4. Click **Apply** to apply any changes you made and keep the window open. Or, click **Save** to apply changes and close the window.

Update a machine in a delivery group

1. Select **Delivery Groups** in the left pane.
2. Select a group and then click **View Machines** in the action bar.
3. Select a machine and then click **Update Machines** in the action bar.

To choose a different image, select **Image** and then select a snapshot.

To apply changes and notify machine users, select **Rollout notification to end-users**. Then specify:

- When to update the master image: now or on the next restart
- The restart distribution time (the total time to begin updating all machines in the group)
- Whether users are notified of the restart
- The message users receive

Add, change, or remove a tag restriction for a desktop

Adding, changing, and removing tag restrictions can have unanticipated effects on which desktops are considered for launch. Review the considerations and cautions in [Tags](#).

1. Select **Delivery Groups** in the left pane.
2. Select a group and then click **Edit** in the action bar.
3. On the **Desktops** page, select the desktop and click **Edit**.
4. To add a tag restriction, select **Restrict launches to machines with the tag** and then select the tag.
5. To change or remove a tag restriction, either:
 - Select a different tag.
 - Remove the tag restriction by clearing **Restrict launches to machines with this tag**.
6. Click **Apply** to apply any changes you made and keep the window open. Or, click **Save** to apply changes and close the window.

Remove a machine from a delivery group

Removing a machine deletes it from a delivery group. It does not delete it from the machine catalog that the delivery group uses. Therefore, that machine is available for assignment to another delivery group.

Machines must be shut down before they can be removed. To temporarily stop users from connecting to a machine while you are removing it, put the machine into maintenance mode before shutting it down.

Machines might contain personal data, so use caution before allocating the machine to another user. Consider reimaging the machine.

1. Select **Delivery Groups** in the left pane.
2. Select a group and then click **View Machines** in the action bar.
3. Ensure that the machine is shut down.
4. Select the machine and then click **Remove from Delivery Group** in the action bar.

You can also remove a machine from a delivery group through the [connection](#) the machine uses.

Restrict access to machines in a delivery group

Any changes you make to restrict access to machines in a delivery group supersede previous settings, regardless of the method you use. You can:

- **Restrict access for administrators using delegated administration scopes:** Create and assign a scope that permits administrators to access all applications, and another scope that provides access to only certain applications. For details, see [Delegated administration](#).
- **Restrict access for users through SmartAccess policy expressions:** Use policy expressions to filter user connections made through Citrix Gateway.
 1. Select **Delivery Groups** in the left pane.
 2. Select a group and then click **Edit** in the action bar.
 3. On the **Access Policy** page, select **Connections through NetScaler Gateway**.
 4. To choose a subset of those connections, select **Connections meeting any of the following filters**. Then define the Citrix Gateway site, and add, edit, or remove the SmartAccess policy expressions for the allowed user access scenarios. For details, see the Citrix Gateway documentation.
 5. Click **Apply** to apply any changes you made and keep the window open. Or, click **Save** to apply changes and close the window.
- **Restrict access for users through exclusion filters:** Use exclusion filters on access policies that you set in the SDK. Access policies are applied to delivery groups to refine connections. For example, you can restrict machine access to a subset of users, and you can specify allowed user devices. Exclusion filters further refine access policies. For example, for security, you can deny access to a subset of users or devices. By default, exclusion filters are disabled.

For example, a teaching lab on a corporate network subnet which prevents access from that lab to a particular delivery group. Regardless of who is using the machines in the lab, use the command: `Set-BrokerAccessPolicy -Name VPDesktops_Direct -ExcludedClientIPFilterEnabled $True -`

Use the asterisk (*) wildcard to match all tags that start with the same policy expression. For example, if you add the tag `VPDesktops_Direct` to one machine and `VPDesktops_Test` to another, setting the tag in the `Set-BrokerAccessPolicy` script to `VPDesktops_*` applies the filter to both machines.

If you are connected using a web browser or with the Citrix Workspace app user experience feature enabled in the store, you cannot use a client name exclusion filter.

Prevent users from connecting to a machine (maintenance mode) in a delivery group

When you need to temporarily stop new connections to machines, you can turn on maintenance mode for one or all machines in a delivery group. You might do this before applying patches or using management tools.

- When a multi-session OS machine is in maintenance mode, users can connect to existing sessions, but cannot start new sessions.

- When a single-session OS machine (or a PC using Remote PC Access) is in maintenance mode, users cannot connect or reconnect. Current connections remain connected until they disconnect or log off.

To turn maintenance mode on or off:

1. Select **Delivery Groups** in the left pane.
2. Select a group.
3. To turn on maintenance mode for all machines in the delivery group, click **Turn On Maintenance Mode** in the action bar.

To turn on maintenance mode for one machine, click **View Machines** in the action bar. Select a machine, and then click **Turn On Maintenance Mode** in the action bar.

4. To turn maintenance mode off for one or all machines in a delivery group, follow the previous instructions, but click **Turn Off Maintenance Mode** in the action bar.

Windows Remote Desktop Connection (RDC) settings also affect whether a multi-session OS machine is in maintenance mode. Maintenance mode is on when any of the following occur:

- Maintenance mode is set to on, as described earlier.
- RDC is set to **Don't allow connections to this computer**.
- RDC is not set to **Don't allow connections to this computer**. The **Remote Host Configuration User Logon Mode** setting is either **Allow reconnections, but prevent new logons** or **Allow reconnections, but prevent new logons until the server is restarted**.

You can also turn maintenance mode on or off for:

- A connection, which affects the machines using that connection.
- A machine catalog, which affects the machines in that catalog.

Shut down and restart machines in a delivery group

This procedure is not supported for Remote PC Access machines.

1. Select **Delivery Groups** in the left pane.
2. Select a group and then click **View Machines** in the action bar.
3. Select the machine and then click one of the following entries in the action bar:
 - **Force shut down:** Forcibly powers off the machine and refreshes the list of machines.
 - **Restart:** Requests the operating system to shut down and then start the machine again. If the operating system cannot comply, the machine remains in its current state.
 - **Force restart:** Forcibly shuts down the operating system and then restarts the machine.

- **Suspend:** Pauses the machine without shutting it down, and refreshes the list of machines.
- **Shut down:** Requests the operating system to shut down.

For non-force actions, if the machine does not shut down within 10 minutes, it is powered off. If Windows attempts to install updates during the shutdown, there is a risk that the machine is powered off before the updates finish.

Citrix recommends that you prevent single-session OS machine users from selecting **Shut down** within a session. See the Microsoft policy documentation for details.

You can also shut down and restart machines on a [connection](#).

Create and manage restart schedules for machines in a delivery group

Note:

- When a restart schedule is applied to a delivery group with Autoscale enabled, its machines are just powered off and left for Autoscale to power them on.
- When restart schedules are applied to random single-session machines, those machines are powered off rather than restarted, to save costs. We recommend that you use Autoscale to power on machines.
- Changing the time zone on a delivery group might reboot the machines in that delivery group. To avoid this, ensure to change the time zone settings outside of production hours.

A restart schedule specifies when machines in a delivery group are periodically restarted. You can create one or more schedules for a delivery group. A schedule can affect either:

- All the machines in the group.
- One or more (but not all) machines in the group. The machines are identified by a tag that you apply to the machine. This is called a tag restriction, because the tag restricts an action to only items that have the tag.

For example, let's say all of your machines are in one delivery group. You want every machine restarted once every week, and you want the machines used by the accounting team restarted daily. To accomplish this, set up one schedule for all machines, and another schedule for only the machines in accounting.

A schedule includes the day and time that the restart begins, and the duration.

You can enable or disable a schedule. Disabling a schedule can be helpful when testing, during special intervals, or when preparing schedules before you need them.

You cannot use schedules for automated power-on or shutdown from the management console, only to restart.

Schedule overlap Multiple schedules can overlap. In the example above, both schedules affect the accounting machines. Those machines might be restarted twice on Sunday. The scheduling code is designed to avoid restarting the same machine more often than intended, but it cannot be guaranteed.

- If the schedules coincide precisely in start and duration times, it is more likely that the machines are restarted only once.
- The more the schedules differ in start and duration times, it's more likely that multiple restarts occur.
- The number of machines affected by a schedule also affects the chance of an overlap. In the example, the weekly schedule that affects all machines might initiate restarts faster than the daily schedule for accounting machines, depending on the duration specified for each.

For an in-depth look at restart schedules, see [Reboot schedule internals](#).

View restart schedules

1. Select **Delivery Groups** in the left pane.
2. Select a group and then click **Edit** in the action bar.
3. Select the **Restart Schedule** page.

The **Restart Schedule** page contains the following information for each configured schedule:

- Schedule name.
- Tag restriction used, if any.
- How often the machine restarts occur.
- Whether machine users receive a notification.
- Whether the schedule is enabled.

Add (apply) tags When you configure a restart schedule that uses a tag restriction, ensure that the tag has been added to the machines that the schedule affects. In the example above, each of the machines used by the accounting team has a tag applied. For details, see [Tags](#).

Although you can apply more than one tag to a machine, a restart schedule can specify only one tag.

1. Select **Delivery Groups** in the left pane.
2. Select the group containing the machines controlled by the schedule.
3. Click **View Machines** and then select the machines you want to add a tag to.
4. Click **Manage Tags** in the action bar.
5. If the tag exists, enable the check box next to the tag name. If the tag does not exist, click **Create** and then specify the name for the tag. After the tag is created, enable the check box next to the newly created tag name.
6. Click **Save** in the **Manage Tags** dialog.

Create a restart schedule

1. Select **Delivery Groups** in the left pane.
2. Select a group and then click **Edit** in the action bar.
3. On the **Restart Schedule** page, click **Add**.
4. On the **Add Restart Schedule** page:
 - To enable the schedule, select **Yes**. To disable the schedule, select **No**.
 - Type a schedule name and description.
 - For **Restrict to tag**, apply a tag restriction.
 - For **Include machines in maintenance mode**, choose whether to include machines that are in maintenance mode in this schedule. To use PowerShell instead, see Scheduled restarts for machines in maintenance mode.
 - For **Restart frequency**, select how often the restart occurs: daily, weekly, monthly, or once. If you select **Weekly** or **Monthly**, you can specify one or more specific days.
 - For **Repeats every**, specify how often you want the schedule to run.
 - For **Start date**, specify a start date for the first occurrence of the schedule.
 - For **Begin restart at**, specify, in 24-hour clock format, the time of day to begin the restart.
 - For **Restart duration**:
 - If you do not want to use natural restart, select **Restart all machines at the same time** or **Restart all machines within a time period**.
 - If you want to use natural restart, select **Restart all machines after draining all sessions**.

Upon starting a restart schedule that is configured to use natural restart:

- * All idle machines belonging to the delivery group are restarted immediately
- * Each machine belonging to a delivery group with one or more active sessions is restarted when all sessions are logged off.

Note:

You can use this option for machines that are power managed and also for machines that are not power managed.

- In **Send notification to users**, choose whether to display a notification message on the applicable machines before a restart begins. By default, no message appears.

- If you choose to display a message 15 minutes before the restart begins, you can choose (in **Notification frequency**) to repeat the message every five minutes after the initial message. By default, the message does not repeat.
- Enter the notification title and text. There is no default text.

If you want the message to include a countdown to restart, include the variable **%m%**. Unless you chose to restart all machines at the same time, the message appears on each machine at the appropriate time before the restart.

5. Click **Done** to apply the changes and to close the **Add Restart Schedule** window.
6. Click **Apply** to apply the changes you made and keep the window open. Or, click **Save** to apply changes and close the window.

Restart after drain Another restart duration value is available when using PowerShell to create or update a machine restart schedule (`New-BrokerRebootSchedulev2` or `Set-BrokerRebootSchedulev2`).

When you enable the restart after drain feature with the `-UseNaturalReboot <Boolean>` parameter, all machines are restarted after draining all sessions. When the restart time is reached, machines are put into the drain state and then restarted when all sessions are logged off.

This feature is supported for delivery groups containing single-session or multi-session machines. You can use this option for machines that are power managed and also for machines that are not power managed.

In an on-premises environment, this feature is supported only when using PowerShell. The feature is not available in Web Studio.

Edit, remove, enable, or disable a restart schedule

1. Select **Delivery Groups** in the left pane.
2. Select a group and then click **Edit** in the action bar.
3. On the **Restart Schedule** page, select the check box for a schedule.
 - To edit a schedule, click **Edit**. Update the schedule configuration, using the guidance in [Create a restart schedule](#).
 - To enable or disable a schedule, click **Edit**. Select or clear the **Enable restart schedule** check box.
 - To remove a schedule, click **Remove**. Confirm the removal. Removing a schedule does not affect any tags applied to machines in the affected machines.

Scheduled restarts delayed due to database outage

Note:

This feature is available only in PowerShell.

If a site database outage occurs before a scheduled restart begins for machines (VDAs) in a delivery group, the restarts begin when the outage ends. This can have unintended results.

For example, let's say you've scheduled a delivery group's restarts to occur during off-production hours (beginning at 03:00). A site database outage occurs one hour before a scheduled restart begins (02:00). The outage lasts six hours (until 08:00). The restart schedule begins when the connection between the Delivery Controller and the site database is restored. The VDA restarts now begin five hours after their original schedule, resulting in VDAs restarting during production hours.

To help avoid this situation, you can use the `MaxOvertimeStartMins` parameter for the `New-BrokerRebootScheduleV2` and `Set-BrokerRebootScheduleV2` cmdlets. The value specifies the maximum number of minutes beyond the scheduled start time that a restart schedule can begin.

- If the database connection is restored within that time (scheduled time + `MaxOvertimeStartMins`), the VDA restarts begin.
- If the database connection is not restored within that time, the VDA restarts do not begin.
- If this parameter is omitted or has a zero value, the scheduled restart begins when the connection to the database is restored, regardless of the outage duration.

For more information, see the cmdlet help. This feature is available only in PowerShell. You cannot set this value when configuring a restart schedule in Web Studio.

Scheduled restarts for machines in maintenance mode

Note:

This feature is available only in PowerShell. The option `IgnoreMaintenanceMode` is supported with Citrix Virtual Apps and Desktops 7 2006 and later.

To indicate whether a restart schedule affects machines that are in maintenance mode, use the `IgnoreMaintenanceMode` option with `BrokerRebootScheduleV2` cmdlets.

For example, the following cmdlet creates a schedule that restarts machines that are in maintenance mode (in addition to machines that aren't in maintenance mode).

```
New-Brokerrebootschedulev2 rebootSchedule1 -DesktopGroupName <myDesktopGroup> -IgnoreMaintenanceMode $true
```

The following cmdlet modifies an existing restart schedule.

```
Set-Brokerrebootschedulev2 rebootSchedule1 -IgnoreMaintenanceMode  
$true
```

For more information, see the cmdlet help. This feature is available only in PowerShell.

Load managed machines in delivery groups

You can load manage multi-session OS machines only.

Load management measures the server load and determines which server to select under the current environment conditions. This selection is based on:

- **Server maintenance mode status:** A multi-session OS machine is considered for load balancing only when maintenance mode is off.
- **Server load index:** Determines how likely a server delivering multi-session OS machines is to receive connections. The index is a combination of load evaluators: the number of sessions and the settings for performance metrics such as CPU, disk, and memory use. Load evaluators are specified in load management policy settings.

A server load index of 10000 indicates that the server is fully loaded. If no other servers are available, users might receive a message that the desktop or application is unavailable when they launch a session.

You can monitor the load index in Director (Monitor), Web Studio (Manage) search, and the SDK.

In console displays, to display the **Server Load Index** column (which is hidden by default), select a machine, right-click a column header, and then select **Select Column**. In the **Machine category**, select **Load Index**.

In the SDK, use the `Get-BrokerMachine` cmdlet. For details, see [CTX202150](#).

- **Concurrent logon tolerance policy setting:** The maximum number of concurrent requests to log on to the server. (This setting is equivalent to load throttling in XenApp 6.x versions.)

When all servers are at or higher than the concurrent logon tolerance setting, the next logon request is assigned to the server with the lowest pending logons. If more than one server meets these criteria, the server with the lowest load index is selected.

Power managed machines in a delivery group

You can power manage only virtual single-session OS machines, not physical machines (including Remote PC Access machines). Single-session OS machines with GPU capabilities cannot be suspended, so power-off operations fail. For multi-session OS machines, you can create a restart schedule.

In delivery groups containing pooled machines, virtual single-session OS machines can be in one of the following states:

- Randomly allocated and in use
- Unallocated and unconnected

In delivery groups containing static machines, virtual single-session OS machines can be:

- Permanently allocated and in use
- Permanently allocated and unconnected (but ready)
- Unallocated and unconnected

During normal use, static delivery groups typically contain both permanently allocated and unallocated machines. Initially, all machines are unallocated, except for manually allocated ones when the delivery group was created. As users connect, machines become permanently allocated. You can fully power manage the unallocated machines in those delivery groups, but only partially manage the permanently allocated machines.

- **Pools and buffers:** For pooled delivery groups and static delivery groups with unallocated machines, a pool (in this instance) is a set of unallocated or temporarily allocated machines that are kept in a powered-on state, ready for users to connect. A user gets a machine immediately after logon. The pool size (the number of machines kept powered-on) is configurable by time of day. For static delivery groups, use the SDK to configure the pool.

A buffer is an extra standby set of unallocated machines that are turned on when the number of machines in the pool falls below a threshold. The threshold is a percentage of the delivery group size. For large delivery groups, a significant number of machines might be turned on when the threshold is exceeded. So, plan delivery group sizes carefully or use the SDK to adjust the default buffer size.

- **Power state timers:** You can use power state timers to suspend machines after users have disconnected for a specified amount of time. For example, machines suspend automatically outside of office hours if users are disconnected for at least 10 minutes.

You can configure timers for weekdays and weekends, and for peak and nonpeak intervals.

- **Partial power management of permanently allocated machines:** For permanently allocated machines, you can set power state timers, but not pools or buffers. The machines are turned on at the start of each peak period, and turned off at the start of each off-peak period. You do not have the fine control that you have with unallocated machines over the number of machines that become available to compensate for machines that are consumed.

Power manage virtual single-session OS machines

1. Select **Delivery Groups** in the left pane.
2. Select a group and then click **Edit Delivery Group** in the action bar.
3. On the **Power Management** page, select **Weekdays** in **Power manage machines**. By default, weekdays are Monday to Friday.

4. For random Delivery groups, in **Machines to be powered on**, click **Edit** and then specify the pool size during weekdays. Then, select the number of machines to power on.
5. In **Peak hours**, set the peak and off-peak hours for each day.
6. Set the power state timers for peak and non-peak hours during weekdays: In **During peak hours > When disconnected**, specify the delay (in minutes) before suspending any disconnected machine in the delivery group, and then select **Suspend**. In **During off-peak hours > When disconnected**, specify the delay before turning off any logged-off machine in the delivery group, and then select **Shutdown**. This timer is not available for delivery groups with random machines.
7. Select **Weekend** in **Power manage machines**, and then configure the peak hours and power state timers for weekends.
8. Click **Apply** to apply any changes you made and keep the window open. Or, click **Save** to apply changes and close the window.

Use the SDK to:

- Shut down, rather than suspend, machines in response to power state timers, or if you want the timers to be based on logoffs, rather than disconnections.
- Change the default weekday and weekend definitions.
- Disable power management. See [CTX217289](#).

Power manage VDI machines transitioning to a different time period with disconnected sessions

Important:

This enhancement applies only to VDI machines with disconnected sessions. It does not apply to VDI machines with logged off sessions.

In earlier releases, a VDI machine transitioning to a time period where an action (disconnect action=**Suspend** or **Shutdown**) was required remained powered on. This scenario occurred if the machine disconnected during a time period (peak or off-peak times) where no action (disconnect action=**Nothing**) was required.

Starting with Citrix Virtual Apps and Desktops 7 1909, the machine is suspended or powered off when the specified disconnection time elapses, depending on the disconnect action configured for the destination time period.

For example, you configure the following power policies for a VDI delivery group:

- Set `PeakDisconnectAction` to “Nothing”
- Set `OffPeakDisconnectAction` to “Shutdown”
- Set `OffPeakDisconnectTimeout` to “10”

For more information about the disconnect action in the power policy, see https://developer-docs.citrix.com/projects/delivery-controller-sdk/en/latest/Broker/about_Broker_PowerMan

[agement/#power-policy](#) and <https://developer-docs.citrix.com/projects/delivery-controller-sdk/en/latest/Broker/Get-BrokerDesktopGroup/>.

In earlier releases, a VDI machine with a session disconnected during peak times remained powered on when it transitioned from peak to off-peak. Starting with Citrix Virtual Apps and Desktops 7 1909, the `OffPeakDisconnectAction` and the `OffPeakDisconnectTimeout` policy actions are applied to the VDI machine on period transition. As a result, the machine is powered off 10 minutes after it transitions to off-peak.

If you want to revert to the previous behavior (that is, take no action on machines that transition from peak to off-peak or off-peak to peak with disconnected sessions), do one of the following:

- Set the `LegacyPeakTransitionDisconnectedBehaviour` registry value to `1`, the equivalent of `true` which enables the previous behavior. By default, the value is `0`, or `false`, which triggers disconnect power policy actions on period transition.
 - Path: `HKEY_LOCAL_MACHINE\SOFTWARE\Citrix\DesktopServer`
 - Name: `LegacyPeakTransitionDisconnectedBehaviour`
 - Type: `REG_DWORD`
 - Data: `0x00000001 (1)`
- Configure the setting by using the `Set-BrokerServiceConfigurationData` PowerShell command. For example:
 - `PS C:\> Set-BrokerServiceConfigurationData HostingManagement.LegacyPeakTransitionDisconnectedBehaviour -SettingValue $true`

A machine must meet the following criteria before power policy actions can be applied to it on period transition:

- Have a disconnected session.
- Have no pending power actions.
- Belong to a VDI (single session) delivery group that transitions to a different time period.
- Have a session that disconnects during a certain time period (peak or off-peak times) and transitions to a period where a power action is assigned.

Change the percentage of VDAs in a powered state for catalogs

1. Adjust the peak hours for the delivery group from the **Power management** section for the delivery group.
2. Make a note of the Desktop Group name.
3. With administrator privileges, start PowerShell and run the following commands. Replace “Desktop Group Name” with the name of your desktop group that has a changed percentage of the VDAs running.

```
asnp Citrix*
```

```
# Set-BrokerDesktopGroup "Desktop Group Name"-PeakBufferSizePercent
  100
```

A value of 100 means that 100% of the VDAs are in the ready state.

4. Verify the solution by running:

```
#Get-BrokerDesktopGroup "Desktop Group Name"
```

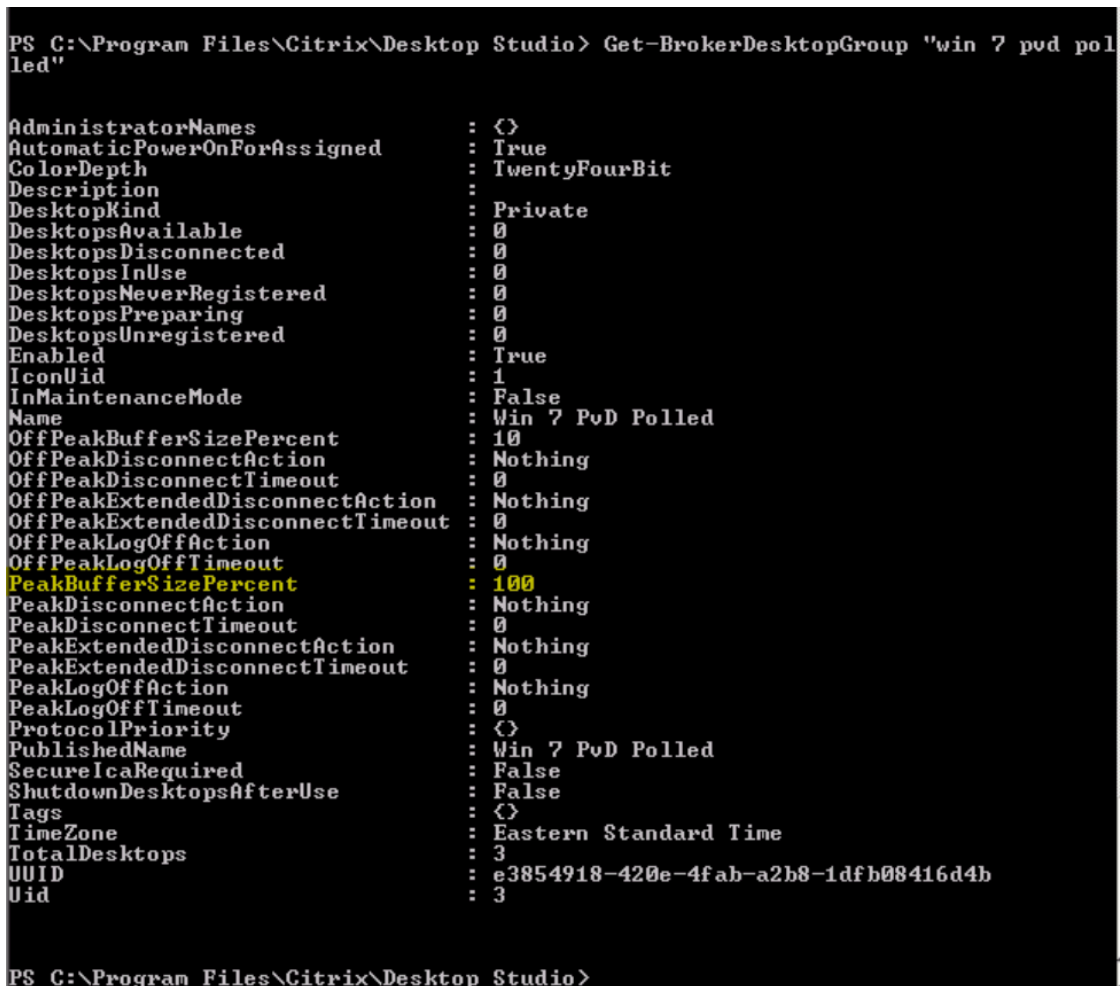

```
PS C:\Program Files\Citrix\Desktop Studio> Get-BrokerDesktopGroup "win 7 pvd pol
led"

AdministratorNames           : {}
AutomaticPowerOnForAssigned   : True
ColorDepth                    : TwentyFourBit
Description                    :
DesktopKind                    : Private
DesktopsAvailable             : 0
DesktopsDisconnected          : 0
DesktopsInUse                  : 0
DesktopsNeverRegistered       : 0
DesktopsPreparing             : 0
DesktopsUnregistered          : 0
Enabled                        : True
IconUid                       : 1
InMaintenanceMode             : False
Name                           : Win 7 PvD Polled
OffPeakBufferSizePercent      : 10
OffPeakDisconnectAction       : Nothing
OffPeakDisconnectTimeout      : 0
OffPeakExtendedDisconnectAction : Nothing
OffPeakExtendedDisconnectTimeout : 0
OffPeakLogOffAction           : Nothing
OffPeakLogOffTimeout          : 0
PeakBufferSizePercent       : 100
PeakDisconnectAction          : Nothing
PeakDisconnectTimeout         : 0
PeakExtendedDisconnectAction   : Nothing
PeakExtendedDisconnectTimeout  : 0
PeakLogOffAction              : Nothing
PeakLogOffTimeout             : 0
ProtocolPriority               : {}
PublishedName                  : Win 7 PvD Polled
SecureIcaRequired              : False
ShutdownDesktopsAfterUse      : False
Tags                           : {}
TimeZone                       : Eastern Standard Time
TotalDesktops                  : 3
UUID                           : e3854918-420e-4fab-a2b8-1dfb08416d4b
Uid                             : 3

PS C:\Program Files\Citrix\Desktop Studio>
```

It can take up to an hour for changes to take effect.

To shut down the VDAs after the user logs off, enter:

```
# Set-BrokerDesktopGroup "Desktop Group Name"-ShutdownDesktopsAfterUse
  $True
```

To restart VDAs during peak hours, so that they're ready for users after they log off, enter:

```
# Set-BrokerDesktopGroup "Desktop Group Name"-AutomaticPowerOnForAssignedDurin
  $True
```

Sessions

- Log off or disconnect a session, or send a message to users
- Configure session prelaunch and session linger
- Control session reconnection when disconnected from machine in maintenance mode
- Configure session roaming

Log off or disconnect a session

1. Select **Delivery Groups** in the left pane.
2. Select a delivery group and then select **View Machines** in the action bar.
3. In the middle pane, select the machine, select **View Sessions** in the action bar, and then select a session.
 - Alternatively, in the middle pane, select the **Session** tab and then select a session.
4. To log off from a session, select **Log off** in the action bar. The session closes and the user is logged out. The machine becomes available to other users unless it is allocated to a specific user.
5. To disconnect a session, select **Disconnect** in the action bar. Applications continue to run in the session and the machine remains allocated to that user. The user can reconnect to the same machine.

You can configure power state timers for single-session OS machines to automatically handle unused sessions. For details, see [Power managed machines](#).

Send a message to a delivery group

1. Select **Delivery Groups** in the left pane.
2. Select a delivery group and then select **View Machines** in the action bar.
3. In the middle pane, select a machine to which you want to send a message.
4. In the action bar, select **View Sessions**.
5. In the middle pane, select all sessions and then select **Send Message** in the action bar.
6. Type your message and click **OK**. You can specify the level of severity if needed. Options include **Critical**, **Question**, **Warning**, and **Information**.

Alternatively, you can send a message using Citrix Director. For more information, see [Send messages to users](#).

Configure session prelaunch and session linger in a delivery group

These features are supported only on multi-session OS machines.

The session prelaunch and session linger features help specified users access applications quickly, by starting sessions before they are requested (session prelaunch) and keeping application sessions active after a user closes all applications (session linger).

By default, session prelaunch and session linger are not used. A session starts (launches) when a user starts an application, and remains active until the last open application in the session closes.

Considerations:

- The delivery group must support applications, and the machines must be running a VDA for multi-session OS, minimum version 7.6.
- These features are supported only when using Citrix Workspace app for Windows, and also require extra Citrix Workspace app configuration. For instructions, search for session prelaunch in the product documentation for your Citrix Workspace app for Windows version.
- Citrix Workspace app for HTML5 is not supported.
- When using session prelaunch, if a user's machine is put into suspend or hibernate mode, prelaunch does not work (regardless of session prelaunch settings). Users can lock their machines/sessions. However, if a user logs off from Citrix Workspace app, the session is ended and prelaunch no longer applies.
- When using session prelaunch, physical client machines cannot use the suspend or hibernate power management functions. Client machine users can lock their sessions but should not log off.
- Prelaunched and lingering sessions consume a concurrent license, but only when connected. If using a user/device license, the license lasts 90 days. Unused prelaunched and lingering sessions disconnect after 15 minutes by default. This value can be configured in PowerShell ([New / Set-BrokerSessionPreLaunch](#) cmdlet).
- Careful planning and monitoring of your users' activity patterns are essential to tailoring these features to complement each other. Optimal configuration balances the benefits of earlier application availability for users against the cost of keeping licenses in use and resources allocated.
- You can also configure session prelaunch for a scheduled time of day in Citrix Workspace app.

How long unused prelaunched and lingering sessions remain active There are several ways to specify how long an unused session remains active if the user does not start an application: a configured timeout and server load thresholds. You can configure all of them. The event that occurs first causes the unused session to end.

- **Timeout:** A configured timeout specifies the number of minutes, hours, or days an unused prelaunched or lingering session remains active. If you configure too short a timeout, prelaunched sessions end before they provide the user benefit of quicker application access. If you configure too long a timeout, incoming user connections might be denied because the server doesn't have enough resources.

You can enable this timeout from the SDK only (`New/Set-BrokerSessionPreLaunch` cmdlet), not from the management console. If you disable the timeout, it does not appear in the console display for that delivery group or in the **Edit Delivery Group** pages.

- **Thresholds:** Automatically ending prelaunched and lingering sessions based on server load ensures that sessions remain open as long as possible, assuming that server resources are available. Unused prelaunched and lingering sessions do not cause denied connections because they are ended automatically when resources are needed for new user sessions.

You can configure two thresholds: the average percentage load of all servers in the delivery group, and the maximum percentage load of a single server in the group. When a threshold is exceeded, the sessions that have been in the prelaunch or lingering state for the longest time are ended. Sessions are ended one-by-one at minute intervals until the load falls below the threshold. While the threshold is exceeded, no new prelaunch sessions are started.

Servers with VDAs that have not registered with a Controller and servers in maintenance mode are considered fully loaded. An unplanned outage causes prelaunch and lingering sessions to end automatically to free capacity.

To enable session prelaunch

1. Select a group and then click **Edit Delivery Group** in the action bar.
2. On the **Application Prelaunch** page, enable session prelaunch by choosing when sessions launch:
 - When a user starts an application. This is the default setting. Session prelaunch is disabled.
 - When any user in the delivery group logs on to Citrix Workspace app for Windows.
 - When anyone in a list of users and user groups logs on to Citrix Workspace app for Windows. Be sure to also specify users or user groups if you choose this option.

Edit Delivery Group
Nanjing-Site

Users
Desktops
Application Prelaunch
Application Linger
User Settings
StoreFront
App Protection
Access Policy
Restart Schedule

When do you want sessions to launch?

Launch when users start an application (no prelaunch)

Prelaunch when any user in the delivery group logs on to Citrix Workspace app for Windows

Prelaunch when any of the following users log on to Citrix Workspace app for Windows:

You have not yet added any users or groups.

Add

If no application is started, when do you want prelaunched sessions to end?

After a specified time:

Hours 2

When average load on all machines exceeds (%):
0

The load on any machine exceeds (%):
0

Save Cancel

3. A prelaunched session is replaced with a regular session when the user starts an application. If the user does not start an application (the prelaunched session is unused), the following settings affect how long that session remains active.
- When a specified time interval elapses. You can change the time interval (1–99 days, 1–2376 hours, or 1–142,560 minutes).
 - When the average load on all machines in the delivery group exceeds a specified percentage (1–99%).
 - When the load on any machine in the delivery group exceeds a specified percentage (1–99%).

Recap: A prelaunched session remains active until one of the following events occurs: a user starts an application, the specified time elapses, or a specified load threshold is exceeded.

To enable session linger

1. Select **Delivery Groups** in the left pane.
2. Select a group and then click **Edit Delivery Group** in the action bar.

3. On the **Application Linging** page, enable session linger by selecting **Keep sessions active until**.

4. Several settings affect how long a lingering session remains active if the user does not start another application.

- When a specified time interval elapses. You can change the time interval: 1–99 days, 1–2376 hours, or 1–142,560 minutes.
- When the average load on all machines in the delivery group exceeds a specified percentage: 1–99%.
- When the load on any machine in the delivery group exceeds a specified percentage: 1–99%.

Recap: A lingering session remains active until one of the following events occurs: a user starts an application, the specified time elapses, or a specified load threshold is exceeded.

Control session reconnection when disconnected from machine in maintenance mode

NOTE:

This feature is available only in PowerShell.

You can control whether sessions that are disconnected on machines in maintenance mode are allowed to reconnect to machines in the delivery group.

Before version 2106, reconnection was not allowed for single-session pooled desktop sessions that had disconnected from machines in maintenance mode. As of version 2106, you can configure a delivery group to allow or prohibit reconnections (regardless of session type) after disconnection from a machine in maintenance mode.

When creating or editing a delivery group (`New-BrokerDesktopGroup`, `Set-BrokerDesktopGroup`), use the `-AllowReconnectInMaintenanceMode <boolean>` parameter to allow or prohibit

reconnections for machines that were disconnected from a machine in maintenance mode.

- When set to true, sessions can reconnect to machines in the group.
- When set to false, sessions cannot reconnect to machines in the group.

Default values:

- Single-session: Disabled
- Multi-session: Enabled

Configure session roaming

By default, session roaming is enabled for delivery groups. Sessions roam between client devices with the user. When the user launches a session and then moves to another device, the same session is used and applications are simultaneously available on both devices. You can view the applications on multiple devices. The applications follow, regardless of the device or whether current sessions exist. Often, printers and other resources assigned to the application also follow. Alternatively, you can use PowerShell. For more information, see [Session roaming](#).

Configure session roaming for applications To configure session roaming for applications, follow these steps:

1. In the console, select **Delivery Groups** in the left pane.
2. Select a group and then select **Edit Delivery Group** in the action bar.
3. On the **Users** page, enable session roaming by selecting the **Sessions roam with users as they move between devices** check box.
 - When enabled, if a user launches an application session and then moves to another device, the same session is used and available on both devices. When disabled, the session no longer roams between devices.
4. Select **OK** to apply changes and close the window.

Configure session roaming for desktops To configure session roaming for a desktop, follow these steps:

1. In the console, select **Delivery Groups** in the left pane.
2. Select a group and then select **Edit** in the action bar.
3. On the **Desktops** page, select the desktop and select **Edit**.
4. Enable session roaming by selecting the **Session roaming** check box.

- When enabled, if the user launches the desktop and then moves to another device, the same session is used, and applications are available on both devices. When disabled, the session no longer roams between devices.

Select **OK** to apply changes and close the window.

Troubleshoot

- VDAs that are not registered with a Delivery Controller are not considered when launching brokered sessions. This results in underutilization of otherwise available resources. There are various reasons that a VDA might not be registered, many of which an administrator can troubleshoot. The details display provides troubleshooting information in the catalog creation wizard, and after you add a catalog to a delivery group.

After you create a delivery group, the details pane for a delivery group indicates the number of machines that can be registered but are not. For example, one or more machines are powered on and not in maintenance mode, but are not currently registered with a Controller. When viewing a “not registered, but should be” machine, review the **Troubleshoot** tab in the details pane for possible causes and recommended corrective actions.

For messages about functional level, see [VDA versions and functional levels](#).

For information about VDA registration troubleshooting, see [CTX136668](#).

- In the display for a delivery group, the **Installed VDA version** in the details pane might differ from the actual version installed on the machines. The machine’s Windows Programs and Features display shows the actual VDA version.
- For machines with **Power State Unknown** status, see [CTX131267](#) for guidance.

Create application groups

August 3, 2023

Note:

You can manage your Citrix Virtual Apps and Desktops deployment using two management consoles: Web Studio (web-based) and Citrix Studio (Windows-based). This article covers only Web Studio. For information about Citrix Studio, see the equivalent article in Citrix Virtual Apps and Desktops 7 2212 or earlier.

Introduction

Application groups let you manage collections of applications. Create application groups for applications shared across different delivery groups. Or, applications used by a subset of users within delivery groups. Application groups are optional; they offer an alternative to adding the same applications to multiple delivery groups. Associate delivery groups with more than one application group, and associate an application group with more than one delivery group.

Using application groups can provide application management and resource control advantages over using more delivery groups:

- The logical grouping of applications and their settings lets you manage those applications as a single unit. For example, you don't have to add (publish) the same application to individual delivery groups one at a time.
- Session sharing between application groups can conserve resource consumption. In other cases, disabling session sharing between application groups can be beneficial.
- You can use the tag restriction feature to publish applications from an application group, considering only a subset of the machines in selected delivery groups. With tag restrictions, you can use your existing machines for more than one publishing task, saving the costs associated with deploying and managing extra machines. A tag restriction can be thought of as subdividing (or partitioning) the machines in a delivery group. Using an application group or desktops with a tag restriction can be helpful when isolating and troubleshooting a subset of machines in a delivery group.

Example configurations

Example 1:

The following graphic shows a Citrix Virtual Apps and Desktops deployment that includes application groups:

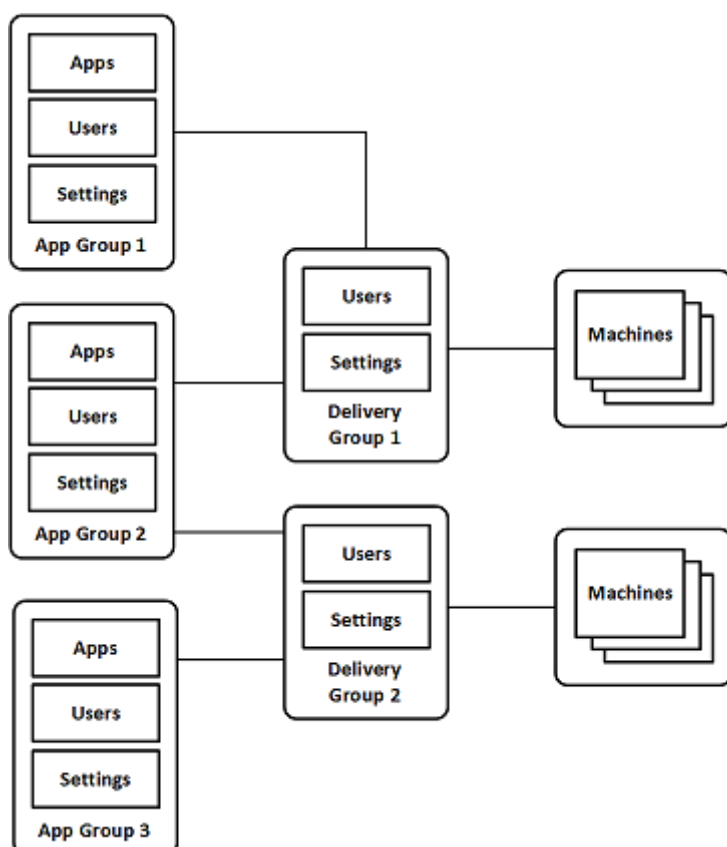

In this configuration, applications are added to the application groups, not the delivery groups. The delivery groups specify which machines are used. (Although not shown, the machines are in machine catalogs.)

Application group 1 is associated with delivery group 1. Access the applications in application group 1 by the users specified in application group 1. These groups only appear as long as they are also in the user list for delivery group 1. This configuration follows the guidance that the user list for an application group is a subset (a restriction) of the user lists for the associated delivery groups. The settings in application group 1 (such as application session sharing between application groups, associated delivery groups) apply to applications and users in that group. The settings in delivery group 1 apply to users in application groups 1 and 2, because those application groups have been associated with that delivery group.

Application group 2 is associated with two delivery groups: 1 and 2. Each of those delivery groups is assigned a priority in application group 2, indicating the order in which the delivery groups are checked when an application is launched. Delivery groups with equal priority are load balanced. Access the applications in application group 2 by the users specified in application group 2. However, they must also appear in the user lists for delivery group 1 and delivery group 2.

Example 2:

This simple layout uses tag restrictions to limit which machines are considered for certain desktop

and application launches. The site has one shared delivery group, one published desktop, and one application group configured with two applications.

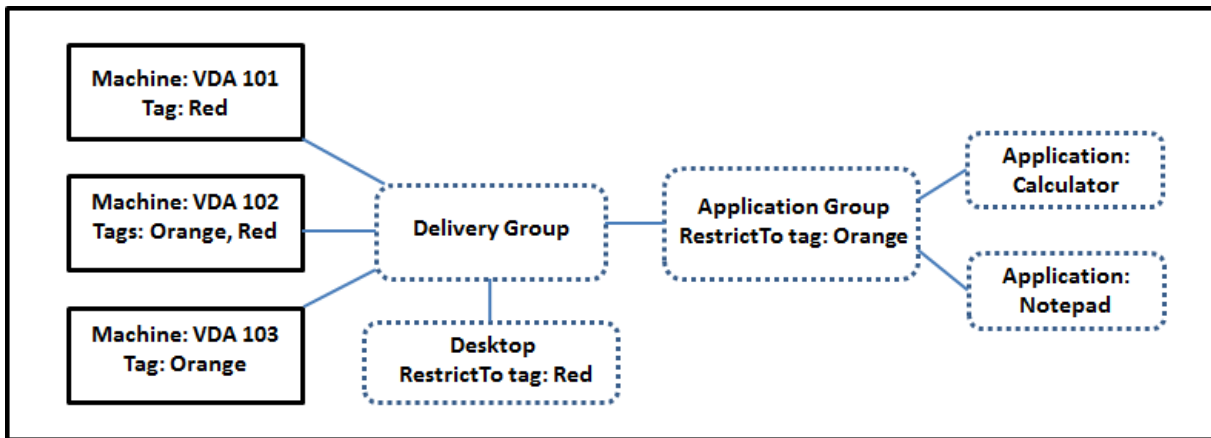

Tags have been added to each of the three machines (VDA 101–103).

The application group was created with the “Orange” tag restriction. Each of its applications is launched only on machines in that delivery group that have the tag “Orange,” VDA 102 and 103.

For more comprehensive examples and guidance for using tag restrictions in application groups (and for desktops), see [Tags](#).

Guidance and considerations

Citrix recommends adding applications to either application groups or delivery groups, but not both. Otherwise, the additional complexity of having applications in two group types can make it more difficult to manage.

By default, an application group is enabled. After you create an application group, you can edit the group to change this setting. See [Manage application groups](#).

By default, application session sharing between application groups is enabled. See [Session sharing between application groups](#).

Citrix recommends upgrading your delivery groups to the current version. This process requires:

1. Upgrading VDAs on the machines used in the delivery group.
2. Upgrading the machine catalogs containing those machines.
3. Upgrading the delivery group.

For details, see [Manage delivery groups](#).

To use application groups, your core components must be minimum version 7.9.

Creating application groups requires the delegated administration permission of the Delivery Group Administrator built-in role. See [Delegated administration](#) for details.

This article refers to “associating” an application with more than one application group. It differentiates that action from adding instances of that application from an available source. Similarly, delivery groups are associated with application groups, rather than being additions or components of one another.

Session sharing with application groups

When application session sharing is enabled, all applications launch in the same application session. This saves the costs associated with launching more application sessions, and allows the use of application features that involve the clipboard, such as copy-paste operations. However, in some situations you can clear session sharing.

When you use application groups you can configure application session sharing in the following three ways which extend the standard session sharing behavior available when you are using only delivery groups:

- Session sharing enabled between application groups.
- Session sharing enabled only between applications in the same application group.
- Session sharing disabled.

Session sharing between application groups

You can enable application session sharing between application groups, or you can disable it to limit application session sharing only to applications in the same application group.

- **An example when enabling session sharing between application groups is helpful:**

Application group 1 contains Microsoft Office applications such as Word and Excel. Application group 2 contains other applications such as Notepad and Calculator, and both application groups are attached to the same delivery group. A user who has access to both application groups starts an application session by launching Word, and then launches Notepad. If the controller finds that the user’s existing session running Word is suitable for running Notepad then Notepad is started within the existing session. If Notepad cannot be run from the existing session—for example if the tag restriction excludes the machine that the session is running on—then a new session on a suitable machine is created rather than using session sharing.

- **An example when disabling session sharing between application groups is helpful:**

A configuration with a set of applications that do not interoperate well with other applications that are installed on the same machines. Such as two different versions of the same software suite or two different versions of the same web browser. You prefer not to allow a user to launch both versions in the same session.

Create an application group for each version of the software suite, and add the applications for each version of the software suite to the corresponding application group. If session sharing between groups is disabled for each of those application groups, a user specified in those groups can run applications of the same version in the same session. The user can still run other applications at the same time, but not in the same session. When launching one of the different-versioned applications, or any application that is not contained in an application group, that application is launched in a new session.

This session sharing between application groups feature is not a security sandboxing feature. It is not foolproof, and it cannot prevent users from launching applications into their sessions through other means (for example, through Windows Explorer).

If a machine is at capacity, new sessions are not started on it. New applications are started in existing sessions on the machine as needed using session sharing.

You can only make prelaunched sessions available to application groups which have application session sharing allowed. (Sessions which use the session linger feature are available to all application groups.) These features must be enabled and configured in each of the delivery groups associated with the application group. You cannot configure them in the application groups.

By default, application session sharing between application groups is enabled when you create an application group. You cannot change this when you create the group. After you create an application group, you can edit the group to change this setting. See [Manage application groups](#).

Disable session sharing within an application group

You can prevent application session sharing between applications which are in the same application group.

- **An example when disabling session sharing within application groups is helpful:**

You want your users to access multiple simultaneous full screen sessions of an application on separate monitors.

You create an application group and add the applications to it.

By default, application session sharing is enabled when you create an application group. You cannot change this setting when you create the group. After you create an application group, you can edit the group to change this setting. See [Manage application groups](#).

Create an application group

To create an application group:

1. Sign in to Web Studio.
2. Select **Applications** in the left pane, and then select the **Application Groups** tab.
3. To organize application groups using folders, create folders under the **Application Groups** root folder.
4. Select the folder where you want to create the group, and then click **Create Application Group**. The group creation wizard launches with an **Introduction** page. You can remove the page from future launches of this wizard.
5. Follow the wizard to configure settings on the pages described below. When you are done with each page, select **Next** until you reach the **Summary** page.

Step 1. Delivery Groups

The **Delivery Groups** page lists all delivery groups, with the number of machines each group contains.

- The **Compatible Delivery Groups** list contains delivery groups that you can select. Compatible delivery groups contain random (not permanently or statically assigned) multi-session or single-session OS machines.
- The **Incompatible Delivery Groups** list contains delivery groups that you cannot select. Each entry explains why it is not compatible, such as containing statically assigned machines.

An application group can be associated with delivery groups containing shared (not private) machines that can deliver applications.

You can also select delivery groups containing shared machines that deliver only desktops, if both of the following conditions are met:

- The delivery group contains shared machines and was created with a XenDesktop version earlier than 7.9.
- You have Edit Delivery Group permission.

The delivery group type is automatically converted to “desktops and applications” when the application group creation wizard is committed.

Although you can create an application group that has no associated delivery groups (perhaps to organize applications or to serve as storage for applications not currently used) the application group cannot be used to deliver applications until it specifies at least one delivery group. Also, you cannot add applications to the application group from the **From Start** menu source if there are no delivery groups specified.

The delivery groups that you select specify the machines that are used to deliver applications. Select the check boxes next to the delivery groups that you want to associate with the application group.

To add a tag restriction, select **Restrict launches to machines with the tag** and then select the tag from the drop-down list.

Step 2. Users

Specify application users in the application group. Either allow all users and user groups in the delivery groups that you selected on the previous page, or select specific users and user groups from those delivery groups. If you restrict use to specified users, then only the users specified in the delivery group, the application group can access the applications in this group. Essentially, the user list in the application group provides a filter on the user lists in the delivery groups.

Enabling or disabling application use by unauthenticated users is available only in delivery groups, not in application groups.

For information about where user lists are specified in a deployment, see [Where user lists are specified](#).

Step 3. Applications

Good to know:

- By default, new applications you add are placed in a folder named **Applications**. You can specify a different folder. If you try to add an application and one with the same name exists in that folder, you are prompted to rename the application you are adding. If you agree with the suggested unique name, the application is added with that new name. Otherwise, you must rename it yourself before it can be added. For details, see [Manage application folders](#).
- You can change an application's properties (settings) when you add it, or later. See [Change application properties](#). If you publish two applications with the same name to the same users, change the **Application name (for user)** property in Web Studio. Otherwise, users see duplicate names in Citrix Workspace app.
- When you add an application to more than one application group, a visibility issue can occur if you do not have sufficient permission to view the application in all of those groups. In such cases, either consult an administrator with greater permissions or have your scope extended to include all the groups to which the application was added.

Click the **Add** from the drop-down menu to display the application sources.

- **From Start menu:** Applications that are discovered on a machine in the selected delivery groups. When you select this source, a new page launches with a list of discovered applications. Select the check boxes of applications to add, and then click **OK**.

This source cannot be selected if you selected any of the following:

- Application groups that have no associated delivery groups.
 - Application groups with associated delivery groups that contain no machines.
 - A delivery group containing no machines.
- **Manually defined:** Applications located in the site or elsewhere in your network. When you select this source, a new page launches where you type the path to the executable, working directory, optional command line arguments, and display names for administrators and users. After entering this information, click **OK**.
 - **Existing:** Applications previously added to the site. When you select this source, a new page launches with a list of discovered applications. Select the check boxes of applications to add and then click **OK**. This source cannot be selected if the site has no applications.
 - **App-V:** Applications in App-V packages. When you select this source, a new page launches where you select **App-V server** or **Application Library**. From the resulting display, select the check boxes of applications to add, and then click **OK**. For more information, see [Deploy and deliver App-V applications](#). This source cannot be selected (or might not appear) if App-V is not configured for the site.

As noted, certain entries in the **Add** drop-down menu are not selectable if there is no valid source of that type. Sources that are incompatible are not listed at all (for example, you cannot add application groups to application groups, so that source is not listed when you create an application group).

Step 4. Scopes

This page appears only if you have previously created a custom scope. By default, the **All** scope is selected. For more information, see [Delegated administration](#).

Step 5. Summary

Enter a name for the application group. You can also (optionally) enter a description.

Review the summary information and then click **Finish**.

Manage application groups

August 3, 2023

Note:

You can manage your Citrix Virtual Apps and Desktops deployment using two management con-

soles: Web Studio (web-based) and Citrix Studio (Windows-based). This article covers only Web Studio. For information about Citrix Studio, see the equivalent article in Citrix Virtual Apps and Desktops 7 2212 or earlier.

Introduction

This article describes how to manage the application groups you [created](#).

See [Applications](#) for information about managing applications in application groups or delivery groups, including how to:

- Add or remove applications in an application group.
- Change application group associations.

Managing application groups requires the delegated administration permissions of the Delivery Group Administrator built-in role. See [Delegated administration](#) for details.

Enable or disable an application group

When an application group is enabled, it can deliver the applications that have been added to it. Disabling an application group disables each application in that group. However, if those applications are also associated with other enabled application groups, they can be delivered from those other groups. If the application was explicitly added to delivery groups associated with the application group, disabling the application group does not affect the applications in those delivery groups.

An application group is enabled when you create it. You cannot change this configuration when you create the group.

1. Select **Applications** in the left pane, and then select the **Application Groups** tab.
2. Select an application group and then select **Edit Application Group** in the action bar.
3. On the **Settings** page, select or clear the **Enable Application Group** check box.
4. Click **Apply** to keep the window open, or click **Save** to apply changes and close the window.

Enable or disable application session sharing between application groups

Session sharing between application groups is enabled when you create an application group. You cannot change this configuration when you create the group. For more information, see [Session sharing with application groups](#).

1. Select **Applications** in the left pane, and then select the **Application Groups** tab.
2. Select an application group and then select **Edit Application Group** in the action bar.

3. On the **Settings** page, select or clear the **Enable application session sharing between Application Groups** check box.
4. Click **Apply** to keep the window open, or click **Save** to apply changes and close the window.

Disable application session sharing within an application group

Session sharing between applications in the same application group is enabled by default when you create an application group. If you disable application session sharing between application groups, session sharing between applications in the same application group remains enabled.

You can use the PowerShell SDK to configure application groups with application session sharing disabled between the applications they contain. In some circumstances this option is desirable. For example, you might want users to start non-seamless applications in full-size application windows on separate monitors.

When you disable application session sharing within an application group, each application in that group launches in a new application session. If a suitable disconnected session is available which is running the same application, it is reconnected. For example, when launching Notepad with a disconnected session with Notepad running, that session is reconnected instead of creating a one. When multiple suitable disconnected sessions are available, one of the sessions is chosen to reconnect to, in a random but deterministic manner. When the situation reoccurs in the same circumstances, the same session is chosen, but the session is not necessarily predictable otherwise.

Use the PowerShell SDK either to disable application session sharing for all applications in an existing application group, or to create a group with application session sharing disabled.

PowerShell cmdlet examples

To disable session sharing, use the Broker PowerShell cmdlets `New-BrokerApplicationGroup` or `Set-BrokerApplicationGroup` with the parameter `SessionSharingEnabled` set to `False` and the parameter `SingleAppPerSession` set to `True`.

- For example, to create an application group with application session sharing disabled for all applications in the group:

```
New-BrokerApplicationGroup AppGr1 -SessionSharingEnabled $False -SingleAppPerSession $True
```

- For example, to disable application session sharing between all applications in an existing application group:

```
Set-BrokerApplicationGroup AppGR1 -SessionSharingEnabled $False -SingleAppPerSession $True
```

Considerations

- To enable the `SingleAppPerSession` property you must set the `SessionSharingEnabled` property to `False`. The two properties must not be enabled at the same time. The `SessionSharingEnabled` parameter refers to sharing sessions between application groups.
- Application session sharing works only for applications that are associated with application groups but are not associated with delivery groups. All applications associated directly with a delivery group share session by default.
- If an application is assigned to multiple application groups, make sure that the groups do not have conflicting settings. For example, one group with the option set to `True`, and another group's option set to `False` results in unpredictable behavior.

Rename an application group

1. Select **Applications** in the left pane, and then select the **Application Groups** tab.
2. Select an application group and then select **Rename Application Group** in the action bar.
3. Specify the new unique name and then click **OK**.

Add, remove, or change the priority of delivery group associations with an application group

An application group can be associated with delivery groups containing shared (not private) machines that can deliver applications.

You can also select delivery groups containing shared machines that deliver only desktops, if both of the following conditions are met:

- The delivery group contains shared machines and was created with a version earlier than 7.9.
- You have Edit Delivery Group permission.

The delivery group type is automatically converted to “desktops and applications” when the **Edit Application Group** dialog is committed.

1. Select **Applications** in the left pane, and then select the **Application Groups** tab.
2. Select an application group and then select **Edit Application Group** in the action bar.
3. Select the **Delivery Groups** page.
4. To add delivery groups, click **Add**. Select the check boxes of available delivery groups. (Incompatible delivery groups cannot be selected.) When you finish your selections, click **OK**.
5. To remove delivery groups, select the check boxes of the groups you want to remove and then click **Remove**. Confirm the deletion when prompted.

6. To change the priority of delivery groups, select the check box of the delivery group and then click **Edit Priority**. Enter the priority (0 = highest) and then click **OK**.
7. Click **Apply** to apply any changes you made and keep the window open, or click **Save** to apply changes and close the window.

Add, change, or remove a tag restriction in an application group

Adding, changing, and removing tag restrictions can have unanticipated effects on which machines are considered for application launch. Review the considerations and cautions in [Tags](#).

1. Select **Applications** in the left pane, and then select the **Application Groups** tab.
2. Select an application group and then select **Edit Application Group** in the action bar.
3. Select the **Delivery Groups** page.
4. To add a tag restriction, select **Restrict launches to machines with the tag** and then select the tag from the drop-down list.
5. To change or remove a tag restriction, select a different tag or remove the tag restriction entirely by clearing **Restrict launches to machines with this tag**.
6. Click **Apply** to apply any changes you made and keep the window open, or click **Save** to apply changes and close the window.

Add or remove users in an application group

For detailed information about users, see [Create application groups](#).

1. Select **Applications** in the left pane, and then select the **Application Groups** tab.
2. Select an application group and then select **Edit Application Group** in the action bar.
3. Select the **Users** page. Indicate whether you want to allow all users in the associated delivery groups to use applications in the application group, or only specific users and groups. To add users, click **Add**, and then specify the users you want to add. To remove users, select one or more users and then click **Remove**.
4. Click **Apply** to apply any changes you made and keep the window open, or click **Save** to apply changes and close the window.

Add, change, or remove an application icon in an application group

Perform the following steps to add, change, or remove an application icon.

1. Select **Applications** in the left pane.
2. On the **Applications** tab, select an application and then select **Properties**.

To make changes at an application group level, navigate to the **Application Groups** tab, select an application in a group, and then select **Properties**.

3. Select the **Delivery** page and then select **Change**. The **Select Icon** window appears.
4. In the **Select Icon** window, do either of the following:
 - To add an icon, select **Add** and then browse to the icon.
 - To remove an icon, select it and then select **Remove**.
 - To change an icon, select it for the application.

Important:

- You cannot add an icon whose size is greater than 200 KB.
- You can add only .icon files.
- You cannot remove built-in icons.
- You cannot remove an icon of an application that is in use.

5. Select **Save** to apply changes and close the window.

Change scopes in an application group

You can change a scope only if you have created a scope (you cannot edit the All scope). For more information, see [Delegated administration](#).

1. Select **Applications** in the left pane, and then select the **Application Groups** tab.
2. Select an application group and then select **Edit Application Group** in the action bar.
3. Select the **Scopes** page. Select or clear the check box next to a scope.
4. Click **Apply** to apply any changes you made and keep the window open, or click **Save** to apply changes and close the window.

Change scopes in an application group

You can change a scope only if you have created a scope (you cannot edit the All scope). For more information, see [Delegated administration](#).

1. Select **Applications** in the left pane, and then select the **Application Groups** tab.
2. Select an application group, and then select **Edit Application Group** in the action bar.
3. Select the **Scopes** page. Select or clear the check box next to the scopes you want to change.
4. Select **Apply** to apply any changes you made and keep the window open, or select **Save** to apply changes and close the window.

Delete an application group

An application must be associated with at least one delivery group or application group. If deleting an application group results in one or more applications no longer belonging to a group, you are warned that deleting that group also removes those applications. You can then confirm or cancel the deletion.

Deleting an application does not delete it from its original source. However, if you want to make it available again, you must add it again.

1. Select **Applications** in the left pane, and then select the **Application Groups** tab.
2. Select an application group and then select **Delete Group** in the action bar.
3. Confirm the deletion when prompted.

Organize application groups using folders

You can create folders to organize application groups for easy access.

Required roles

By default, you can create and manage folders for application groups if you have one of the following built-in roles:

- Cloud Administrator
- Full Administrator
- Application Group Administrator

You can delegate management actions to other users by creating custom roles. The following table lists the permissions required for each action.

| Action | Required permissions |
|------------------------------------|--|
| Create application group folders | Create Application Group Folder |
| Delete application group folders | Remove Application Group Folder |
| Move application groups folders | Move Application Group Folder |
| Rename application group folders | Edit Application Group Folder |
| Move application groups to folders | Edit Application Group Folder, Edit Application Group Properties |

For more information, see [Create and manage roles](#).

Create and manage folders

You can use the Actions bar or the right-click menu to create and manage application group folders. In addition, you can drag an application group or a folder to a desired location in the folder tree.

Good to know:

- You can nest folders up to five levels (excluding the default root folder).
- A folder can contain application groups and subfolders. You can delete a folder only if it and its subfolders don't contain application groups.
- All nodes (such as machine catalogs, delivery groups, applications, and application groups) share a folder tree in the back-end. To avoid name conflicts with other resource folders when renaming or moving folders, we recommend you give different names to first-level folders in different folder trees.

Remote PC Access

April 11, 2023

Note:

You can manage your Citrix Virtual Apps and Desktops deployment using two management consoles: Web Studio (web-based) and Citrix Studio (Windows-based). This article covers only Web Studio. For information about Citrix Studio, see the equivalent article in Citrix Virtual Apps and Desktops 7 2212 or earlier.

Remote PC Access is a feature of Citrix Virtual Apps and Desktops that enables organizations to easily allow their employees to access corporate resources remotely in a secure manner. The Citrix platform makes this secure access possible by giving users access to their physical office PCs. If users can access their office PCs, they can access all the applications, data, and resources they need to do their work. Remote PC Access eliminates the need to introduce and provide other tools to accommodate teleworking. For example, virtual desktops or applications and their associated infrastructure.

Remote PC Access uses the same Citrix Virtual Apps and Desktops components that deliver virtual desktops and applications. As a result, the requirements and process of deploying and configuring Remote PC Access are the same as those required for deploying Citrix Virtual Apps and Desktops for the delivery of virtual resources. This uniformity provides a consistent and unified administrative experience. Users receive the best user experience by using Citrix HDX to deliver their office PC session.

The feature consists of a machine catalog of type **Remote PC Access** that provides this functionality:

- Ability to add machines by specifying OUs. This ability facilitates the addition of PCs in bulk.
- Automatic user assignment based on the user that logs into the office Windows PC. We support single user and multiple users assignments. By default, we automatically assign multiple users to the next unassigned machine. To restrict automatic assignment to a single user, sign in to Web Studio, go to **Settings** and turn off the **Enable automatic assignment of multiple users for Remote PC Access** setting.

Citrix Virtual Apps and Desktops can accommodate more use cases for physical PCs by using other types of machine catalogs. These use cases include:

- Physical Linux PCs
- Pooled physical PCs (that is, randomly assigned, not dedicated)

Notes:

For details on the supported OS versions, see the system requirements for the VDA for [single-session OS](#) and [Linux VDA](#).

For on-premises deployments, Remote PC Access is valid only for Citrix Virtual Apps and Desktops Advanced or Premium licenses. Sessions consume licenses in the same way as other Citrix Virtual Desktops sessions. For Citrix Cloud, Remote PC Access is valid for Citrix DaaS (formerly Citrix Virtual Apps and Desktops service) and Workspace Premium Plus.

Considerations

While all the technical requirements and considerations that apply to Citrix Virtual Apps and Desktops in general also apply to Remote PC Access, some might be more relevant or exclusive to the physical PC use case.

Important:

Windows 11 physical systems (and some running Windows 10) include virtualization-based security features that result in the VDA software's incorrectly detecting them as virtual machines. To mitigate this issue, you have the following options:

- Use the “/physicalmachine” option along with the “/remotepc” option as part of the VDA command-line installation
- Add the following registry value after the VDA is installed if the aforementioned option was not used

`HKEY_LOCAL_MACHINE\SOFTWARE\Citrix\PortICA`

- Name: ForceEnableRemotePC

- Type: DWORD
- Data: 1

Deployment considerations

While planning the deployment of Remote PC Access, make a few general decisions.

- You can add Remote PC Access to an existing Citrix Virtual Apps and Desktops deployment. Before choosing this option, consider the following:
 - Are the current Delivery Controllers or Cloud Connectors appropriately sized to support the additional load associated with the Remote PC Access VDAs?
 - Are the on-premises site databases and database servers appropriately sized to support the additional load associated with the Remote PC Access VDAs?
 - Will the existing VDAs and the new Remote PC Access VDAs exceed the number of maximum supported VDAs per site?
- You must deploy the VDA to office PCs through an automated process. The following are the available options:
 - Electronic Software Distribution (ESD) tools such as SCCM: [Install VDAs using SCCM](#).
 - Deployment scripts: [Install VDAs using scripts](#).
- Review the [Remote PC Access security considerations](#).

Note:

When designing Remote PC Access, you must consider the number of physical monitors connected to the GPU on the remote PC and currently configured/operating. Even if the monitor is not used in the Citrix session, but is detected by the GPU, the monitor's presence is counted towards the maximum supported monitor limit by the GPU.

Machine catalog considerations

The type of machine catalog required depends on the use case:

- Remote PC Access machine catalog
 - Windows dedicated PCs
 - Windows dedicated multi-user PCs. This use case applies to physical office PCs that multiple users can access remotely in different shifts.
 - Pooled Windows PCs. This use case applies to physical PCs that multiple random users can access, such as computer labs.
- Single-session OS machine catalog

- Static - Dedicated Linux PCs
- Random - Pooled Linux PCs

Once you identify the type of machine catalog, consider the following:

- A machine can be assigned to only one machine catalog at a time.
- To facilitate delegated administration, consider creating machine catalogs based on geographic location, department, or any other grouping that eases delegating administration of each catalog to the appropriate administrators.
- When choosing the OUs in which the machine accounts reside, select lower-level OUs for greater granularity. If such granularity is not required, you can choose higher-level OUs. For example, in the case of Bank/Officers/Tellers, select **Tellers** for greater granularity. Otherwise, you can select **Officers** or **Bank** based on the requirement.
- Moving or deleting OUs after being assigned to a Remote PC Access machine catalog affects VDA associations and causes issues with future assignments. Therefore, make sure to plan accordingly so that OU assignment updates for machine catalogs are accounted for in the Active Directory change plan.
- If it is not easy to choose OUs to add machines to the machine catalog because of the OU structure, you don't have to select any OUs. You can use PowerShell to add machines to the catalog afterward. User auto-assignments continue to work if the desktop assignment is configured correctly in the Delivery Group. A sample script to add machines to the machine catalog along with user assignments is available in [GitHub](#).
- Integrated Wake on LAN is available only with the **Remote PC Access** type machine catalog.

Linux VDA considerations

These considerations are specific to the Linux VDA:

- Use the Linux VDA on physical machines only in non-3D mode. Due to limitations on NVIDIA's driver, the local screen of the PC cannot be blacked out and displays the activities of the session when HDX 3D mode is enabled. Showing this screen is a security risk.
- Use machine catalogs of type single-session OS for physical Linux machines.
- Automatic user assignment is not available for Linux machines.
- If users are already logged on to their PCs locally, attempts to launch the PCs from StoreFront fail.
- Power saving options are not available for Linux machines.

Technical requirements and considerations

This section contains the technical requirements and considerations for physical PCs.

- The following are not supported:
 - KVM switches or other components that can disconnect a session.
 - Hybrid PCs, including All-in-One and NVIDIA Optimus laptops and PCs.
 - Dual boot machines.
- Connect the keyboard and mouse directly to the PC. Connecting to the monitor or other components that can be turned off or disconnected, can make these peripherals unavailable. If you must connect the input devices to components such as monitors, do not turn those components off.
- The PCs must be joined to an Active Directory Domain Services domain.
- Secure Boot is supported on Windows 10 and Windows 11 only.
- The PC must have an active network connection. A wired connection is preferred for greater reliability and bandwidth.
- If using Wi-Fi, do the following:
 1. Set the power settings to leave the wireless adapter turned on.
 2. Configure the wireless adapter and network profile to allow automatic connection to the wireless network before the user logs on. Otherwise, the VDA does not register until the user logs on. The PC isn't available for remote access until a user has logged on.
 3. Ensure that the Delivery Controllers or Cloud Connectors can be reached from the Wi-Fi network.
- You can use Remote PC Access on laptop computers. Ensure that the laptop is connected to a power source instead of running on the battery. Configure the laptop power options to match the options of a desktop PC. For example:
 1. Disable the hibernate feature.
 2. Disable the sleep feature.
 3. Set the close lid action to **Do Nothing**.
 4. Set the “press the power button” action to **Shut Down**.
 5. Disable video card and NIC energy-saving features.
- Remote PC Access is supported on Surface Pro devices with Windows 10. Follow the same guidelines for laptops mentioned previously.
- If using a docking station, you can undock and redock laptops. When you undock the laptop, the VDA reregisters with the Delivery Controllers or Cloud Connectors over Wi-Fi. However, when you redock the laptop, the VDA doesn't switch to use the wired connection unless you disconnect the wireless adapter. Some devices provide built-in functionality to disconnect the wireless adapter upon establishing a wired connection. The other devices require custom solutions

or third-party utilities to disconnect the wireless adapter. Review the Wi-Fi considerations mentioned previously.

Do the following to enable docking and undocking for Remote PC Access devices:

1. In the **Start** menu, select **Settings > System > Power & Sleep**, and set **Sleep** to **Never**.
 2. Under the **Device Manager > Network adapters > Ethernet adapter** go to **Power Management** and clear **Allow the computer to turn off this device to save power**. Ensure that **Allow this device to wake the computer** is checked.
- Multiple users with access to the same office PC see the same icon in Citrix Workspace. When a user logs on to Citrix Workspace, that resource appears as unavailable if already in use by another user.
 - Install the Citrix Workspace app on each client device (for example, a home PC) that accesses the office PC.

Configuration sequence

This section contains an overview of how to configure Remote PC Access when using the **Remote PC Access** type machine catalog. For information on how to create other types of machine catalogs, see the [Create machine catalogs](#).

1. On-premises site only - To use the integrated Wake on LAN feature, configure the prerequisites outlined in [Wake on LAN](#).
2. If a new Citrix Virtual Apps and Desktops site was created for Remote PC Access:
 - a) Select the **Remote PC Access** Site type.
 - b) On the **Power Management** page, choose to enable or disable power management for the default Remote PC Access machine catalog. You can change this setting later by editing the machine catalog properties. For details on configuring Wake on LAN, see [Wake on LAN](#).
 - c) Complete the information on the **Users** and **Machine Accounts** pages.

Completing these steps creates a machine catalog named **Remote PC Access Machines** and a Delivery Group named **Remote PC Access Desktops**.

3. If adding to an existing Citrix Virtual Apps and Desktops site:
 - a) Create a machine catalog of type **Remote PC Access** (Operating System page of the wizard). For details on how to create a machine catalog, see [Create machine catalogs](#). Make sure to assign the correct OU so that the target PCs are made available for use with Remote PC Access.
 - b) Create a Delivery Group to provide users access to the PCs in the machine catalog. For details on how to create a Delivery Group, see [Create Delivery Groups](#). Make sure to assign

the Delivery Group to an Active Directory group that contains the users that require access to their PCs.

4. Deploy the VDA to the office PCs.

- We recommend using the single-session OS core VDA installer (VDAWorkstationCore-Setup.exe).
- You can also use the single-session full VDA installer (VDAWorkstationSetup.exe) with the `/remotepc/physicalmachine` option, which achieves the same outcome as using the core VDA installer.

Note:

For RemotePC installation, use `/physicalmachine` argument with `/remotepc` for VDA to behave as expected in certain user scenarios.

- Consider enabling Windows Remote Assistance to allow help desk teams to provide remote support through Citrix Director. To do so, use the `/enable_remote_assistance` option. For details, see [Install using the command line](#).
- To be able to see logon duration information in Director, you must use the single-session full VDA installer and include the **Citrix User Profile Management WMI Plugin** component. Include this component by using the `/includeadditional` option. For details, see [Install using the command line](#).
- For information about deploying the VDA using SCCM, see [Install VDAs using SCCM](#).
- For information about deploying the VDA through deployment scripts, see [Install VDAs using scripts](#).

After you successfully complete steps 2–4, users are automatically assigned to their own machines when they log in locally on the PCs.

5. Instruct users to download and install Citrix Workspace app on each client device that they use to access the office PC remotely. Citrix Workspace app is available from <https://www.citrix.com/downloads/> or the application stores for supported mobile devices.

Features managed through the registry

Caution:

Editing the registry incorrectly can cause serious problems that might require you to reinstall your operating system. Citrix cannot guarantee that problems resulting from the incorrect use

of Registry Editor can be solved. Use Registry Editor at your own risk. Be sure to back up the registry before you edit it.

Disable multiple user auto-assignments

On each Delivery Controller, add the following registry setting:

`HKEY_LOCAL_MACHINE\Software\Citrix\DesktopServer`

- Name: AllowMultipleRemotePCAssignments
- Type: DWORD
- Data: 0

Sleep mode (minimum version 7.16)

To allow a Remote PC Access machine to go into a sleep state, add this registry setting on the VDA, and then restart the machine. After the restart, the operating system power saving settings are respected. The machine goes into sleep mode after the preconfigured idle timer passes. After the machine wakes up, it reregisters with the Delivery Controller.

`HKEY_LOCAL_MACHINE\SOFTWARE\Citrix\PortICA`

- Name: DisableRemotePCSleepPreventer
- Type: DWORD
- Data: 1

Session management

By default, a remote user's session is automatically disconnected when a local user initiates a session on that machine (by pressing CTRL+ALT+DEL). To prevent this automatic action, add the following registry entry on the office PC, and then restart the machine.

`HKEY_LOCAL_MACHINE\SOFTWARE\Citrix\PortICA\RemotePC`

- Name: SasNotification
- Type: DWORD
- Data: 1

By default, the remote user has preference over the local user when the connection message is not acknowledged within the timeout period. To configure the behavior, use this setting:

`HKEY_LOCAL_MACHINE\SOFTWARE\Citrix\PortICA\RemotePC`

- Name: RpcaMode

- Type: DWORD
- Data:
 - 1 - The remote user always has preference if he or she does not respond to the messaging UI in the specified timeout period. This behavior is the default if this setting is not configured.
 - 2 - The local user has preference.

The timeout for enforcing the Remote PC Access mode is 30 seconds by default. You can configure this timeout but do not set it lower than 30 seconds. To configure the timeout, use this registry setting:

`HKLM\SOFTWARE\Citrix\PortICA\RemotePC`

- Name: RpcaTimeout
- Type: DWORD
- Data: number of seconds for timeout in decimal values

When a user wants to forcibly get the console access: The local user can press Ctrl+Alt+Del twice in a gap of 10 seconds to get local control over a remote session and force a disconnect event.

After the registry change and machine restart, if a local user presses Ctrl+Alt+Del to log on to that PC while it is in use by a remote user, the remote user receives a prompt. The prompt asks whether to allow or deny the local user's connection. Allowing the connection disconnects the remote user's session.

Session management logging

Remote PC Access now has logging capabilities that log when someone tries to access a PC with an active ICA session. This allows you to monitor your environment for unwanted or unexpected activity and be able to audit such events if you need to investigate any incidents.

Events are logged using Windows Event Viewer and are in **Applications and Services > Citrix > Host-Core > ICA Service > Admin**.

There are three distinct events that are logged when using Remote PC Access.

Ctrl+Alt+Del event

This event appears when the local user presses Ctrl+Alt+Del on the console keyboard with an active remote session.

Event details

- Log name: Application and Services
- Event ID: 43, 44, 45
- Source: ICA Service

Event ID 43 This event ID appears when the SasNotification registry value does not exist or when the SasNotification registry value is 0.

- Message:

```
1      Ctrl+Alt+Del has been pressed on the endpoint.  
2      The session management behavior is set to automatically  
        disconnect the remote session.
```

Event ID 44 This event ID appears when the SasNotification registry value is 1 and the RpcMode registry value is 1 or the RpcMode registry value does not exist.

- Message:

```
1      Ctrl+Alt+Del has been pressed on the endpoint.  
2      The session management behavior is set to notify the  
        remote user. The user preference is set to remote user  
        .
```

Event ID 45 This event ID appears when the SasNotification registry value is 1 and the RpcMode registry value is 2.

- Message:

```
1      Ctrl+Alt+Del has been pressed on the endpoint.  
2      The session management behavior is set to notify the  
        remote user.  
3      The user preference is set to local user.
```

Remote session disconnect event

This event appears when the remote session has been disconnected for various reasons.

Event details

- Log name: Application and Services
- Event ID: 46, 47, 48
- Source: ICA Service

Event ID 46 This event ID appears when the remote session has been disconnected and when the SasNotification registry value does not exist or the SasNotification registry value is 0.

- Message:

```
1 The remote session for <remoteUserName> has been
   disconnected.
```

Event ID 47 This event ID appears when the remote user agrees to disconnect the session and when the SasNotification registry value is 1 and the RpcMode registry value is 1 or the RpcMode registry value is 2 or the RpcMode registry value does not exist.

- Message:

```
1 The remote session for <remoteUserName> has been
   disconnected because the user accepted the request to
   disconnect the session.
```

Event ID 48 This event ID appears when the remote user does not decline the disconnect request within the specific timeout period and when the SasNotification registry value is 1 and the RpcMode registry value is 2.

- Message:

```
1 The remote session for <remoteUserName> has been
   disconnected because the user did not decline the
   disconnection request within the configured timeout
   period (<timeout period>).
```

Ctrl+Alt+Del pressed twice event This event appears when Ctrl+Alt+Del is pressed twice within 10 seconds.

Event details

- Log name: Application and Services
- Event ID: 49
- Source: ICA Service

Event ID 49 This event ID appears when Ctrl+Alt+Del is pressed twice within 10 seconds.

- Message:

```
1 The remote session for <remoteUserName> has been forcibly
   disconnected.
```

Wake on LAN

Remote PC Access supports Wake on LAN, which gives users the ability to turn on physical PCs remotely. This feature enables users to keep their office PCs turned off when not in use to save energy costs. It also enables remote access when a machine has been turned off inadvertently.

With the Wake on LAN feature, the magic packets are sent directly from the VDA running on the PC to the subnet in which the PC resides when instructed by the delivery controller. This allows the feature to work without dependencies on extra infrastructure components or third-party solutions for delivery of magic packets.

The Wake on LAN feature differs from the legacy SCCM-based Wake on LAN feature. For information on the SCCM-based Wake on LAN, see [Wake on LAN –SCCM-integrated](#).

System requirements

The following are the system requirements for using the Wake on LAN feature:

- Control plane:
 - Citrix DaaS
 - Citrix Virtual Apps and Desktops 2009 or later
- Physical PCs:
 - VDA version 2009 or later
 - Windows 10 or Windows 11. For supportability details, see the [VDA system requirements](#).
 - Wake on LAN enabled in BIOS/UEFI
 - Wake on LAN enabled in network adapter’s properties within Windows configuration

Configure Wake on LAN

If you are using Citrix Virtual Apps and Desktops on-premises, the configuration of integrated Wake on LAN is only supported using PowerShell.

To configure Wake on LAN:

1. Create the Remote PC Access machine catalog if you do not have one already.
2. Create the Wake on LAN host connection if you do not have one already.

Note:

To use the Wake on LAN feature, if you have a host connection of the “Microsoft Configuration Manager Wake on LAN” type, create a new host connection.

3. Retrieve the Wake on LAN host connection's unique identifier.
4. Associate the Wake on LAN host connection with a machine catalog.

To create the Wake on LAN host connection:

```

1 # Load Citrix SnapIns
2 Add-PSSnapIn -Name "*citrix*"
3
4 # Provide the name of the Wake on LAN host connection
5 [string]$connectionName = "Remote PC Access Wake on LAN"
6
7 # Create the hypervisor connection
8 $hypHc = New-Item -Path xdhyp:\Connections `
9             -Name $connectionName `
10            -HypervisorAddress "N/A" `
11            -UserName "wo\user" `
12            -Password "wo\pwd" `
13            -ConnectionType Custom `
14            -PluginId VdaWOLMachineManagerFactory `
15            -CustomProperties "<CustomProperties></CustomProperties
16                               >" `
17            -Persist
18 $bhc = New-BrokerHypervisorConnection -HypHypervisorConnectionUid
19            $hypHc.HypervisorConnectionUid
20 # Wait for the connection to be ready before trying to use it
21 while (-not $bhc.IsReady)
22 {
23
24     Start-Sleep -s 5
25     $bhc = Get-BrokerHypervisorConnection -HypHypervisorConnectionUid
26         $hypHc.HypervisorConnectionUid
27 }
28 <!--NeedCopy-->

```

When the host connection is ready, run the following commands to retrieve the host connection's unique identifier:

```

1 $bhc = Get-BrokerHypervisorConnection -Name "<WoL Connection Name>"
2 $hypUid = $bhc.Uid
3 <!--NeedCopy-->

```

After you retrieve the connection's unique identifier, run the following commands to associate the connection with the Remote PC Access machine catalog:

```

1 Get-BrokerCatalog -Name "<Catalog Name>" | Set-BrokerCatalog -
2     RemotePCHypervisorConnectionUid $hypUid
3 <!--NeedCopy-->

```

Design considerations

When you are planning to use Wake on LAN with Remote PC Access, consider the following:

- Multiple machine catalogs can use the same Wake on LAN host connection.
- For a PC to wake up another PC, both PCs must be in the same subnet and use the same Wake on LAN host connection. It does not matter if the PCs are in the same or different machine catalogs.
- Host connections are assigned to specific zones. If your deployment contains more than one zone, you need a Wake on LAN host connection in each zone. The same applies to machine catalogs.
- Magic packets are broadcasted using the global broadcast address 255.255.255.255. Ensure that the address is not blocked.
- There must be at least one PC turned on in the subnet - for every Wake on LAN connection - to be able to wake up machines in that subnet.

Operational considerations

The following are considerations for using the Wake on LAN feature:

- The VDA must register at least once before the PC can be woken up using the integrated Wake on LAN feature.
- Wake on LAN can only be used to wake up PCs. It does not support other power actions, such as restart or shut down.
- After the Wake on LAN connection is created, it is visible in Web Studio. However, editing its properties within Web Studio is not supported if using Citrix Virtual Apps and Desktops on-premises.
- Magic packets are sent in one of the two ways:
 1. When a user tries to launch a session to their PC and the VDA is unregistered
 2. When an administrator manually sends a power on command from Web Studio or Power-Shell
- Because the delivery controller is unaware of a PC's power state, Web Studio displays **Not Supported** under power state. The delivery controller uses the VDA registration state to determine whether a PC is on or off.

Wake on LAN –SCCM-integrated

SCCM-integrated Wake on LAN is an alternative Wake on LAN option for Remote PC Access that is only available with on-premises Citrix Virtual Apps and Desktops.

System requirements

The following are the system requirements for using the SCCM-integrated Wake on LAN feature:

- Citrix Virtual Apps and Desktops 1912 or later
- Physical PCs:
 - VDA version 1912 or later
 - Windows 10. For supportability details, see the [VDA system requirements](#).
 - Wake on LAN enabled in BIOS/UEFI
 - Wake on LAN enabled in network adapter's properties within Windows configuration
- System Center Configuration Manager (SCCM) 2012 R2 or later

Configure SCCM-integrated Wake on LAN

Complete the following prerequisites:

1. Configure SCCM 2012 R2, 2016, or 2019 within the organization. Then deploy the SCCM client to all Remote PC Access machines, allowing time for the scheduled SCCM inventory cycle to run, or force one manually, if necessary.
2. For Wake Proxy support, enable the option in SCCM. For each subnet in the organization that contains PCs that use the Remote PC Access Wake on LAN feature, ensure that three or more machines can serve as sentinel machines.
3. For magic packet support, configure network routers and firewalls to allow magic packets to be sent, using either a subnet-directed broadcast or unicast.
4. Configure Wake on LAN in each PC's BIOS/UEFI settings.
5. Deploy the VDA to the physical PCs if you haven't done it already.

After you address the prerequisites, complete the following steps to allow the Delivery Controller to communicate with SCCM:

1. Create a host connection for SCCM. For more information, see [Connections and resources](#).
 - Select **Microsoft Configuration Manager Wake on LAN** as the connection type.
 - The credentials entered must have access to the collections in the scope and must have the **Remote Tools Operator** role.
2. Select the connection in Web Studio, then select **Edit Connection**, and click **Advanced**.
3. Select the appropriate option for handling Wake on LAN:
 - If you are using Wake-up proxy, select the first option: **Microsoft System Center Configuration Manager Wake-up proxy**.

- If you are using magic packets, select the second option: **Wake on LAN packets transmitted by the Delivery Controller**.
 - Select the appropriate transmission method: **subnet-directed broadcasts** or **unicast**.

After you create the host connection, associate the connection with a Remote PC Access catalog:

- If you are creating a new Remote PC Access catalog, in the **Operating System** page of the catalog creation wizard, select **Remote PC Access** as the catalog type and choose the appropriate connection from the drop-down list.
- To add Wake on LAN to an existing Remote PC Access catalog:
 1. Go to the **Machine Catalogs** node in Web Studio, select the machine catalog, and then select **Edit Machine Catalog**.
 2. Select the **Power Management** tab and choose **Yes** to enable power management for the machine catalog.
 3. Select the appropriate connection from the drop-down list and click **OK**.

Troubleshoot

Monitor blanking not working

If the Windows PC's local monitor is not blank while there is an active HDX session (the local monitor displays what's happening in the session) it is likely due to issues with the GPU vendor's driver. To resolve the issue, give the Citrix Indirect Display driver (IDD) higher priority than the graphic card's vendor driver by setting the following registry value:

`HKEY_LOCAL_MACHINE\SOFTWARE\Citrix\Graphics\AdapterMerits`

- Name: CitrixIDD
- Type: DWORD
- Data: 3

For more details about display adapter priorities and monitor creation, see the Knowledge Center article [CTX237608](#).

Session disconnects when you select Ctrl+Alt+Del on the machine that has session management notification enabled

The session management notification controlled by the **SasNotification** registry value only works when Remote PC Access mode is enabled on the VDA. If the physical PC has the Hyper-V role or any virtualization-based security features enabled, the PC reports as a virtual machine. If the VDA detects

that it is running on a virtual machine, it automatically disables Remote PC Access mode. To enable Remote PC Access mode, add the following registry value:

`HKEY_LOCAL_MACHINE\SOFTWARE\Citrix\PortICA`

- Name: ForceEnableRemotePC
- Type: DWORD
- Data: 1

Restart the PC for the setting to take effect.

Diagnostic information

Diagnostic information about Remote PC Access is written to the Windows Application Event log. Informational messages are not throttled. Error messages are throttled by discarding duplicate messages.

- 3300 (informational): Machine added to catalog
- 3301 (informational): Machine added to delivery group
- 3302 (informational): Machine assigned to user
- 3303 (error): Exception

Power management

If power management for Remote PC Access is enabled, subnet-directed broadcasts might fail to start machines that are on a different subnet from the Controller. If you need power management across subnets using subnet-directed broadcasts, and AMT support is not available, try the Wake-up proxy or Unicast method. Ensure those settings are enabled in the advanced properties for the power management connection.

The active remote session records the local touchscreen input

When the VDA enables Remote PC Access mode, the machine ignores the local touchscreen input during an active session. If the physical PC has the Hyper-V role or any virtualization-based security features enabled, the PC reports as a virtual machine. If the VDA detects that it is running on a virtual machine, it automatically disables Remote PC Access mode. To enable Remote PC Access mode, add the following registry setting:

`HKEY_LOCAL_MACHINE\SOFTWARE\Citrix\PortICA`

- Name: ForceEnableRemotePC
- Type: DWORD

- Data: 1

Restart the PC for the setting to take effect.

More resources

The following are other resources for Remote PC Access:

- Solution design guidance: [Remote PC Access Design Decisions](#).
- Examples of Remote PC Access architectures: [Reference Architecture for Citrix Remote PC Access Solution](#).

Publish content

April 7, 2023

Note:

You can manage your Citrix Virtual Apps and Desktops deployment using two management consoles: Web Studio (web-based) and Citrix Studio (Windows-based). This article covers only Web Studio. For information about Citrix Studio, see the equivalent article in Citrix Virtual Apps and Desktops 7 2212 or earlier.

You can publish an application that is simply a URL or UNC path to a resource, such as a Microsoft Word document or a web link. This feature is known as published content. The ability to publish content adds flexibility to how you deliver content to users. You benefit from the existing access control and management of applications. You can also specify whether to use local or published applications to open the content.

The published content appears just like other applications in StoreFront and Citrix Workspace app. Users access it in the same way they access applications. On the client, the resource opens as usual.

- If a locally installed application is appropriate, it is launched to open the resource.
- If a File Type Association has been defined, a published application launches to open the resource.

You publish content using the PowerShell SDK. You cannot use Web Studio to publish content. However, you can use Web Studio to edit application properties later, after they are published.

Configuration overview and preparation

Publishing content uses the `New-BrokerApplication` cmdlet with the following key properties. (See the cmdlet help for descriptions of all cmdlet properties.)

```
1 New-BrokerApplication - ApplicationType PublishedContent -  
   CommandLineExecutable location -Name app-name -DesktopGroup delivery  
   -group-name  
2 <!--NeedCopy-->
```

The `ApplicationType` property must be `PublishedContent`.

The `CommandLineExecutable` property specifies the location of the published content. The following formats are supported, with a limit of 255 characters.

- HTML website address (for example, <http://www.citrix.com>)
- Document file on a web server (for example, <https://www.citrix.com/press/pressrelease.doc>)
- Directory on an FTP server (for example, <ftp://ftp.citrix.com/code>)
- Document file on an FTP server (for example, <ftp://ftp.citrix.com/code/Readme.txt>)
- UNC directory path (for example, `file://myServer/myShare` or `\\\\myServer\\myShare`)
- UNC file path (for example, `file://myServer/myShare/myFile.asf` or `\\myServer\\myShare\\myFile.asf`)

Ensure that you have the correct SDK.

- For Citrix DaaS (formerly Citrix Virtual Apps and Desktops service) deployments, [download](#) and install the Citrix Virtual Apps and Desktops Remote PowerShell SDK.
- For on-premises Citrix Virtual Apps and Desktops deployments, use the PowerShell SDK that is installed with the Delivery Controller. Adding a published content application requires a minimum version 7.11 Delivery Controller.

The following procedures use examples. In the examples:

- A machine catalog has been created.
- A delivery group named `PublishedContentApps` has been created. The group uses a multi-session OS machine from the catalog. The WordPad application has been added to the group.
- Assignments are made for the delivery group name, the `CommandLineExecutable` location, and the application name.

Get started

On the machine containing the PowerShell SDK, open PowerShell.

The following cmdlet adds the appropriate PowerShell SDK snap-in, and assigns the returned delivery group record.

```
Add-PsSnapin Citrix\* $dg = Get-BrokerDesktopGroup -Name PublishedContentApps
```

If you are using Citrix DaaS, authenticate by entering your Citrix Cloud credentials. If there is more than one customer, choose one.

Publish a URL

After assigning the location and application name, the following cmdlet publishes the Citrix home page as an application.

```
1 $citrixUrl = "https://www.citrix.com/"
2 $appName = "Citrix Home Page"
3
4 New-BrokerApplication -ApplicationType PublishedContent -
   CommandLineExecutable $citrixUrl -Name $appName -DesktopGroup $dg.
   Uid
5 <!--NeedCopy-->
```

Verify success:

- Open StoreFront and log on as a user who can access applications in the PublishedContentApps delivery group. The display includes the newly created application with the default icon. To learn about customizing the icon, see <https://www.citrix.com/blogs/2013/08/21/xd-tipster-changing-delivery-group-icons-revisited-xd7/>.
- Click the **Citrix Home Page** application. The URL launches in a new tab in a locally running instance of your default browser.

Publish resources located at UNC paths

In this example, the administrator has already created a share named `PublishedResources`. After assigning the locations and application names, the following cmdlets publish an RTF and a DOCX file in that share as a resource.

```
1 $rtfUNC = "\\GMSXJ-EDGE0.xd.local\\PublishedResources\\PublishedRTF.rtf"
2 $rtfAppName = "PublishedRTF"
3
4 New-BrokerApplication -ApplicationType PublishedContent
5 -CommandLineExecutable $rtfUNC -Name $rtfAppName
6 -DesktopGroup $dg.Uid
7
```

```

8 $docxUNC = "\\GMSXJ-EDGE0.xd.local\PublishedResources\PublishedDOCX.docx"
9 $docxAppName = "PublishedDOCX"
10
11 New-BrokerApplication -ApplicationType PublishedContent
12 -CommandLineExecutable $docxUNC -Name $docxAppName
13 -DesktopGroup $dg.Uid
14 <!--NeedCopy-->

```

Verify success:

- Refresh your StoreFront window to see the newly published documents.
- Click the **PublishedRTF** and **PublishedDOCX** applications. Each document opens in a locally running WordPad.

View and edit PublishedContent applications

You manage published content using the same methods that you use for other application types.

To view and edit **PublishedContent** applications, follow these steps:

1. Sign in to Web Studio and select **Applications** in the left pane.
2. On the **Applications** tab, select a **PublishedContent** application, and then select **Properties**.

Application properties (such as user visibility, group association, and shortcut) apply to the published content. However, you cannot change the command-line argument or working directory properties on the **Location** page.

3. To change the resource, modify the **Path to the executable file** field on that page.

The screenshot shows the 'Application Settings' dialog box for a 'Command Prompt' application. The 'Location' tab is active in the left-hand navigation pane. The main area is divided into two sections: 'Identification' and 'Location'. The 'Location' section contains the following fields:

- Path to the executable file:** A text input field containing the path `\\Test-server\PublishContentDemo\PublishedRTF.rtf`.
- Command-line argument (optional):** A text input field containing the text `Example: https://www.Example.com`.
- Working directory:** A text input field containing the environment variable `%HOMEDRIVE%%HOMEPATH%`.

4. To use a published application to open a **PublishedContent** application (rather than a local application), follow these steps:

In this example, the published WordPad application is edited to create a File Type Association for `.rtf` files.

- a) Turn on maintenance mode for the delivery group.
- b) Edit the **File Type Association** property.
- c) Turn off maintenance mode when you're done.
- d) Refresh StoreFront to load the File Type Association changes, and then click the **PublishedRTF** and **PublishedDOCX** applications. Notice the difference. **PublishedDOCX** still opens in the local WordPad. However, **PublishedRTF** now opens in the published WordPad due to the file type association.

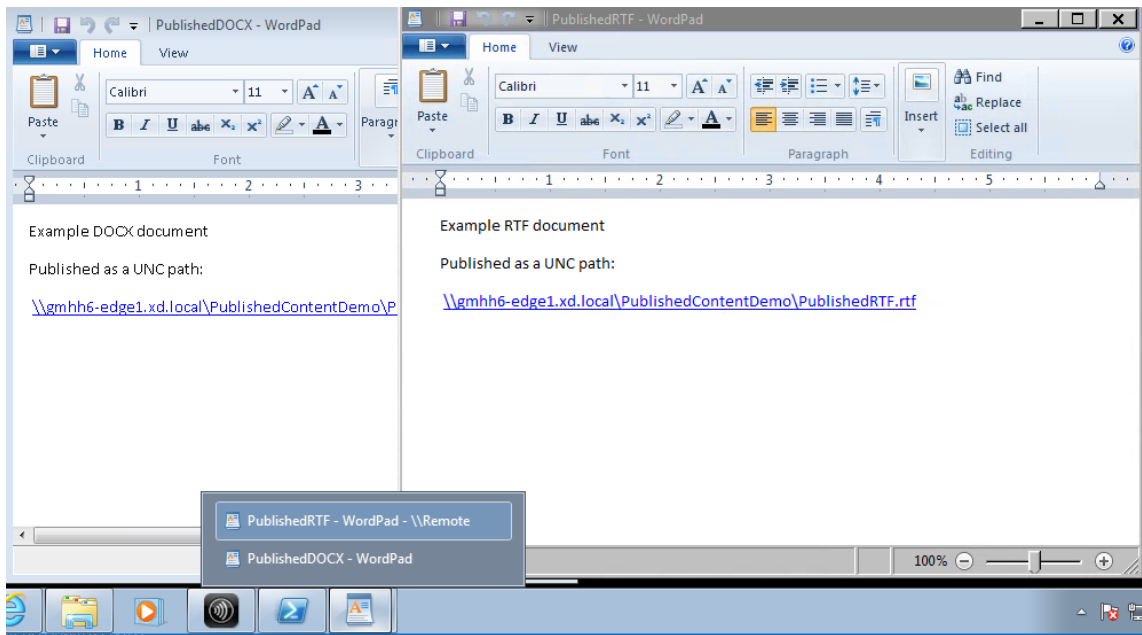

For more information

- [Create machine catalogs](#)
- [Create delivery groups](#)
- [Change application properties](#)

Server VDI

April 19, 2022

Use the Server VDI (Virtual Desktop Infrastructure) feature to deliver a desktop from a server operating system for a single user.

- Enterprise administrators can deliver server operating systems as VDI desktops, which can be valuable for users such as engineers and designers.

- Service Providers can offer desktops from the cloud. Those desktops comply with the Microsoft Services Provider License Agreement (SPLA).

Support:

- In Citrix Virtual Apps and Desktops and Citrix DaaS (formerly Citrix Virtual Apps and Desktops service) deployments, Server VDI is supported on Windows Server 2022, Windows Server 2019, and Windows Server 2016.
- All Server VDI deployments support the user personalization layer technology.
- For Server VDI to work with TWAIN devices such as scanners, the Windows Server Desktop Experience feature must be installed.
- The following features cannot be used with Server VDI:
 - Hosted applications
 - Local App Access
 - Direct (non-brokered) desktop connections
 - Remote PC Access

Install and configure Server VDI

1. Prepare the Windows server for installation.
 - Use Windows Server Manager to ensure that the Remote Desktop Services role services are not installed. If they were previously installed, remove them. The VDA installation fails if these role services are installed.
 - Ensure that the **Restrict each user to a single session** property is enabled. On the Windows server, edit the registry for the Terminal Server setting:

```
HKEY_LOCAL_MACHINE\SYSTEM\CurrentControlSet\Control\Terminal Server
```

```
DWORD fSingleSessionPerUser = 1
```
2. Use the Citrix Virtual Apps and Desktops installer's command line interface to install a VDA on a supported server or server master image, specifying the `/quiet` and `/servervdi` options. (By default, the installer's graphical interface blocks the Windows single-session OS VDA on a server operating system. Using the command line overrides this behavior.) Use one of the following commands:
 - Citrix Virtual Apps and Desktops deployments:
 - `XenDesktopVdaSetup.exe /quiet /servervdi`
 - `VDAWorkstationSetup.exe /quiet /servervdi`

- Citrix DaaS deployments:
 - `VDAWorkstationSetup.exe /quiet /servervdi`

Other options:

- Use `/controllers` to specify Delivery Controllers or Cloud Connectors.
- Use `/enable_hdx_ports` to open ports in the firewall, unless the firewall is to be configured manually.
- Use `/mastermcsimage` (or `/masterimage`) if you are installing the VDA on an image, and will use MCS to create server VMs from that image.
- For all option details, see [Install using the command line](#).

3. Create a machine catalog for Server VDI. In the catalog creation wizard:

- On the **Operating System** page, select **Single-session OS**.
- On the **Summary** page, specify a machine catalog name and description for administrators that clearly identifies it as Server VDI. This is the only indicator in Studio that the catalog supports Server VDI.

When using search in Studio, the Server VDI catalog is displayed on the **Single-session OS Machines** tab, even though the VDA is installed on a multi-session machine.

4. Create a Delivery Group and select the Server VDI catalog you created.

If you did not specify Delivery Controllers or Cloud Connectors during VDA installation, remember to specify them afterward. For details, see [VDA registration](#).

User personalization layer

April 4, 2024

Note:

You can manage your Citrix Virtual Apps and Desktops deployment using two management consoles: Web Studio (web-based) and Citrix Studio (Windows-based). This article covers only Web Studio. For information about Citrix Studio, see the equivalent article in Citrix Virtual Apps and Desktops 7 2212 or earlier.

The user personalization layer feature for Citrix Virtual Apps and Desktops extends the capabilities of non-persistent machine catalogs to preserve users' data and locally installed applications across sessions. Powered by underlying Citrix App Layering technology, the user personalization layer feature supports Citrix Provisioning and Machine Creation Services (MCS) in a non-persistent machine catalog.

You install the user personalization layer components alongside the Virtual Delivery Agent within the master image. A VHD file stores locally user-installed applications. The VHD mounted on the image acts as the user's own virtual hard drive.

Important:

You can deploy user personalization layers in Citrix Virtual Apps and Desktops, or App Layering user layers enabled in an image template, not both. Don't install the user personalization layer feature on a layer within App Layering.

This feature replaces Personal vDisk (PvD), while also providing a persistent workspace experience for users in a non-persistent (pooled) desktop environment.

To deploy the user personalization layer feature, install and configure it using the steps detailed in the article.

Application support

Aside from the following exceptions, all applications that a user installs locally on the desktop are supported in the user personalization layer.

Exceptions

The following applications are the exception and are not supported on the user personalization layer:

- Enterprise applications, such as MS Office and Visual Studio.
- Applications that modify the network stack or hardware. Example: a VPN client.
- Applications that have boot level drivers. Example: a virus scanner.
- Applications with drivers that use the driver store. Example: a printer driver.

Note:

You can make printers available using Windows Group Policy Objects (GPOs).

Do *not* allow users to install any unsupported applications locally. Rather, install these applications directly on the master image.

Applications that require a local user or administrator account

When a user installs an application locally, the app goes into their user layer. If the user then adds or edits a local user or group, the changes do not persist beyond the session.

Important:

Add any required local user or group in the master image.

Requirements

The user personalization layer feature requires the following components:

- Citrix Virtual Apps and Desktops 7 1909 or later
- Virtual Delivery Agent (VDA), version 1912 or later
- Citrix Provisioning, version 1909 or later
- Windows File Share (SMB), or Azure Files with on-prem AD authentication enabled

You can deploy the User personalization layer feature on the following Windows versions when the OS is deployed as a single session. Support is limited to a single user on a single session.

- Windows 11 Enterprise x64
- Windows 10 Enterprise x64, version 1607 or later
- Windows Server 2016 (Azure Files supported)
- Windows Server 2019 (Azure Files supported)
- Windows Server 2022 (Azure Files supported)

For Citrix Virtual Apps and Desktops 7, the use of Azure Files with User personalization layers is supported on Windows Server 2022, Windows Server 2019, Windows Server 2016, and Windows 10 clients.

Note:

If you are using a server OS, only Server VDI is supported. For deployment details, see the [Server VDI](#) article.

User personalization layer supports just one user at a time per machine, and then the machine has to reboot to reset the disks. You cannot use the user personalization layer with multi-session server operating systems, only with single-session server systems. User personalization layer is supported for non-persistent desktops only.

Uninstall the user personalization layer feature, if installed. Reboot the master image before installing the latest release.

Set up your file share

The user personalization layer feature requires Windows Server Message Block (SMB) storage. To create a Windows file share, follow the usual steps for the Windows operating system that you are on.

For more about using Azure Files with Azure-based catalogs, see [Set up Azure Files storage for User personalization layers](#).

Recommendations

Follow the recommendations in this section for a successful user personalization layer deployment.

Microsoft System Center Configuration Manager (SCCM)

If you are using SCCM with the user personalization layer feature, follow the Microsoft guidelines for preparing your image in a VDI environment. Refer to this [Microsoft TechNet article](#) for more information.

User layer size

A user layer is a thin-provisioned disk that expands as space on the disk is used. The default size allowed for a user layer is 10 GB, the minimum we recommend.

Note:

During installation, if the value is set to zero (0), the default user layer size is set to 10 GB.

If you want to change the user layer size, you can enter a different value for the **User Layer Size** policy. See **Step 5: Create delivery group custom policies**, under **Optional: Click Select next to User Layer Size in GB**.

Tools for overriding the User Layer Size (Optional)

You can override the User Layer Size by using a Windows tool to define a quota on the user layer file share.

Use one of the following Microsoft quota tools to set a hard quota on the user layer directory named **Users**:

- File Server Resource Manager (FSRM)
- Quota Manager

Note:

Increasing the quota affects new user layers and expands existing ones. Decreasing the quota only affects new user layers. Existing user layers never decrease in size.

Deploy a User personalization layer

When deploying the user personalization feature, you define the policies within Web Studio. You then assign the policies to the delivery group bound to the machine catalog, where the feature is deployed.

If you leave the master image with no user personalization layer configuration, the services remain idle and do not interfere with authoring activities.

If you set the policies in the master image, the services attempt to run and mount a user layer within the master image. The master image exhibits unexpected behaviors and instability.

To deploy the user personalization layer feature, complete the following steps in this order:

- Step 1: Verify the availability of a Citrix Virtual Apps and Desktops environment.
- Step 2: Prepare your master image.
- Step 3: Create a machine catalog.
- Step 4: Create a delivery group.
- Step 5: Create delivery group custom policies.

Note:

Logging in for the first time after upgrading Windows 10 on the image takes longer than usual. The user's layer needs to update for the new version of Windows 10, which then increases logon time.

Step 1: Verify that the Citrix Virtual Apps and Desktops environment is available

Ensure that your Citrix Virtual Apps and Desktops environment is available to use with this new feature. For setup details, see [Install and configure Citrix Virtual Apps and Desktops](#).

Step 2: Prepare your master image

To prepare your master image:

1. Locate the master image. Install your organization's enterprise applications and any other apps your users generally find useful.
2. If you are deploying Server VDI, follow the steps in the [Server VDI](#) article. Be sure to include the optional component, the **User personalization layer**. For details, see the [Command-line options for installing a VDA](#).
3. If you are using Windows 10, install Virtual Delivery Agent (VDA) 1912 or later. If an older version of the VDA is already installed, uninstall the old version first. When installing the new version,

be sure to select and install the optional component, the **Citrix User Personalization Layer**, as follows:

- a) Click the **Virtual Delivery Agent for Windows Desktop OS** tile:

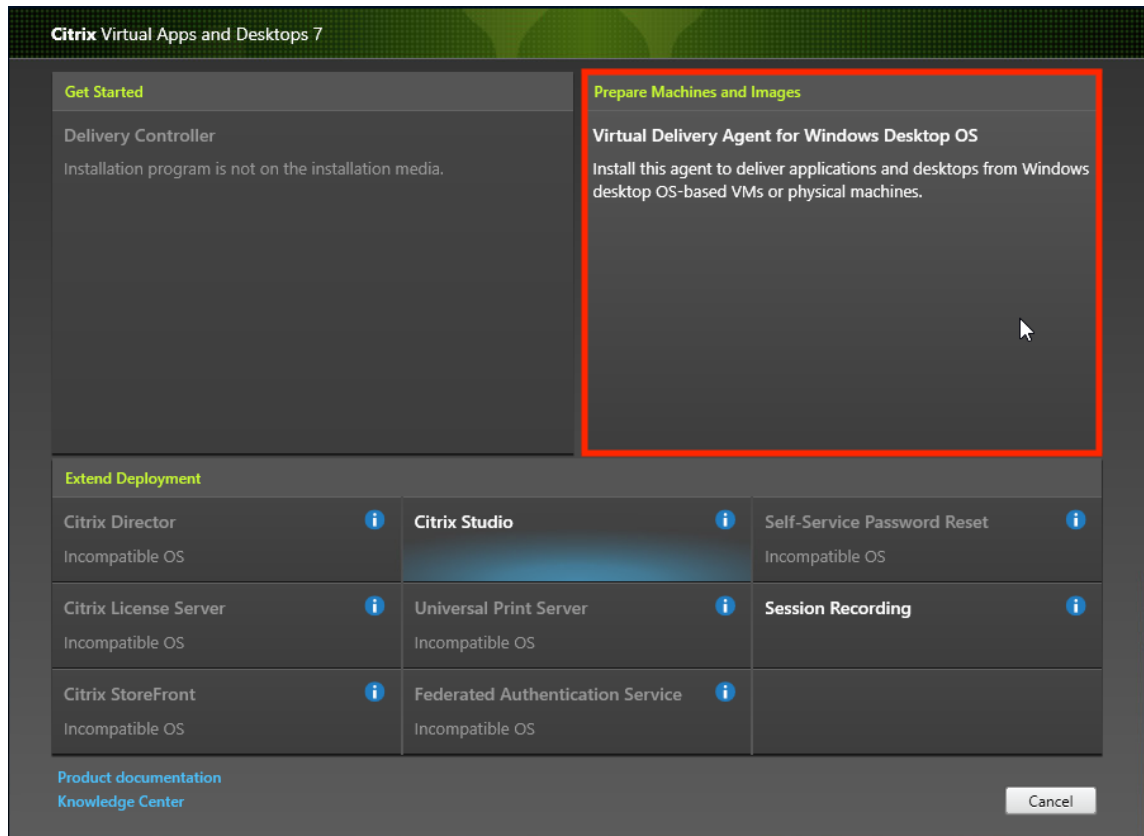

- a) **Environment:** Select either **Create a master MCS image** or **Create a master image using Citrix Provisioning or third-party provisioning tools**.

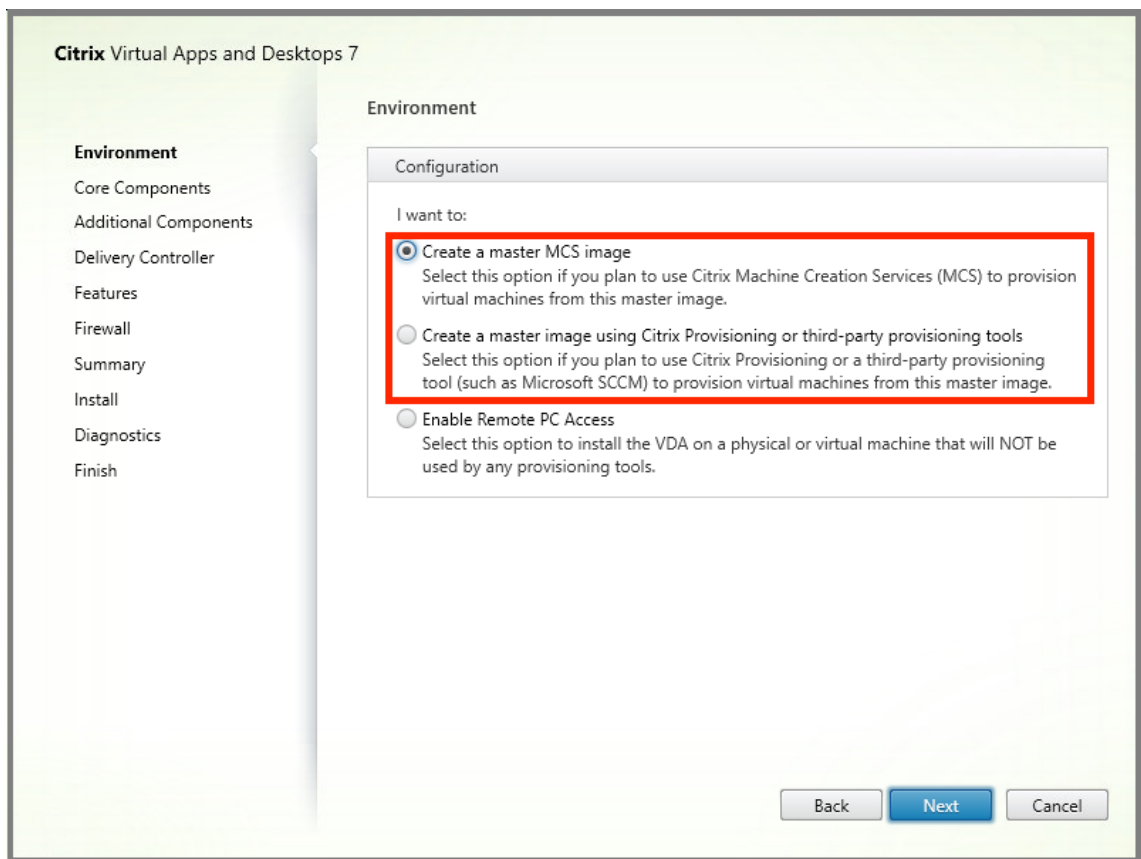

- a) **Core Components:** Click **Next**.
- b) **Additional Components:** Check **Citrix User Personalization Layer**.

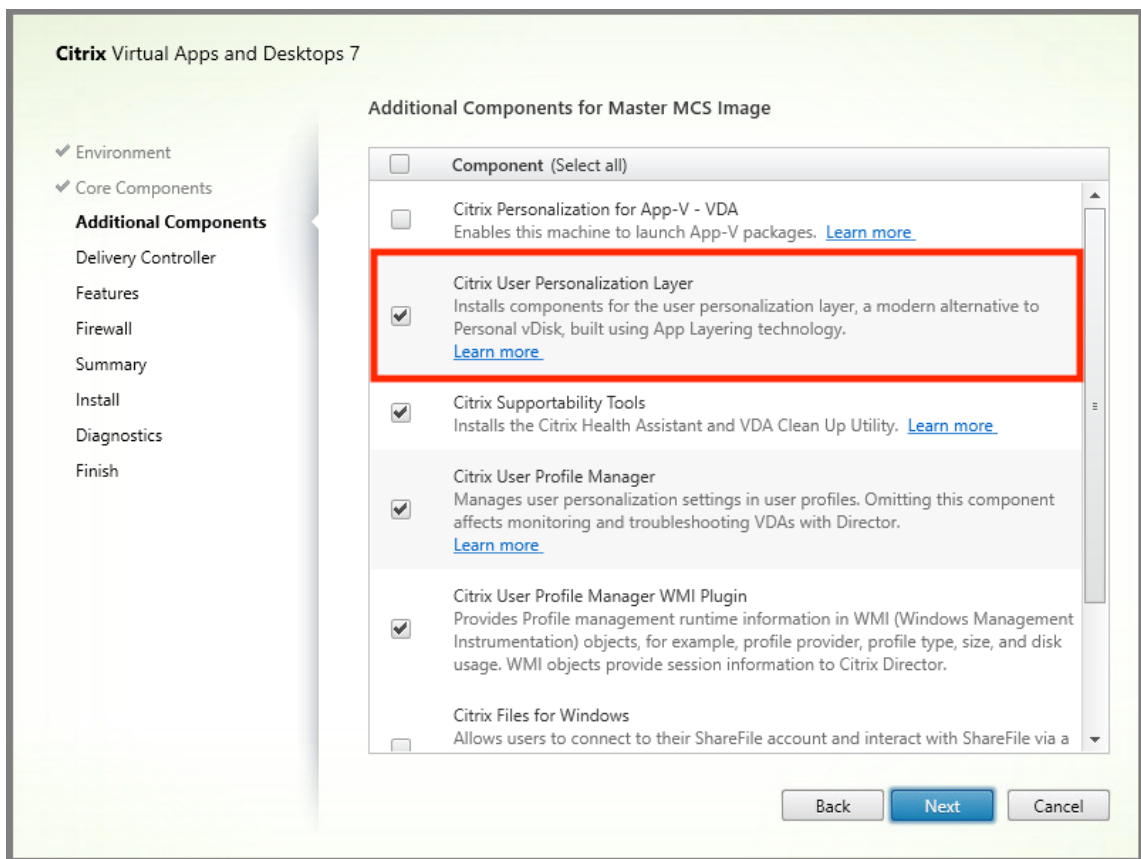

- a) Click through the remaining installation screens, configure the VDA as needed, and click **Install**. The image reboots one or more times during installation.
4. Leave **Windows updates** disabled. The user personalization layer installer disables Windows updates on the image. Leave the updates disabled.

The image is ready for you to upload into Web Studio.

Note:

If you simply want to upgrade the user personalization layer (UPL), you can do so with a newer version of UPL and the standalone package. You do not need to upgrade the VDA.

Step 3: Create a machine catalog

In Web Studio, follow the steps to create a machine catalog. Use the following options during catalog creation:

1. Select **Operating System** and set it to **Single-session OS**.
2. Select **Machine Management** and set it to **Machines that are power managed**. For example, virtual machines or blade PCs.

3. Select **Desktop Experience** and set it to either **pooled-random** or **pooled-static** catalog type, as in the following examples:

- **Pooled-random:**

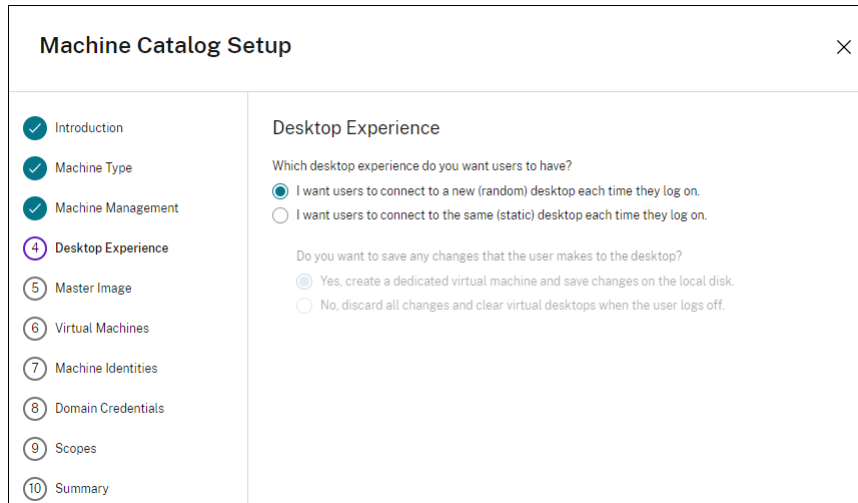

- **Pooled-static:** If you select pooled-static, configure desktops to discard all changes and clear virtual desktops when the user logs off, as shown in the following screenshot:

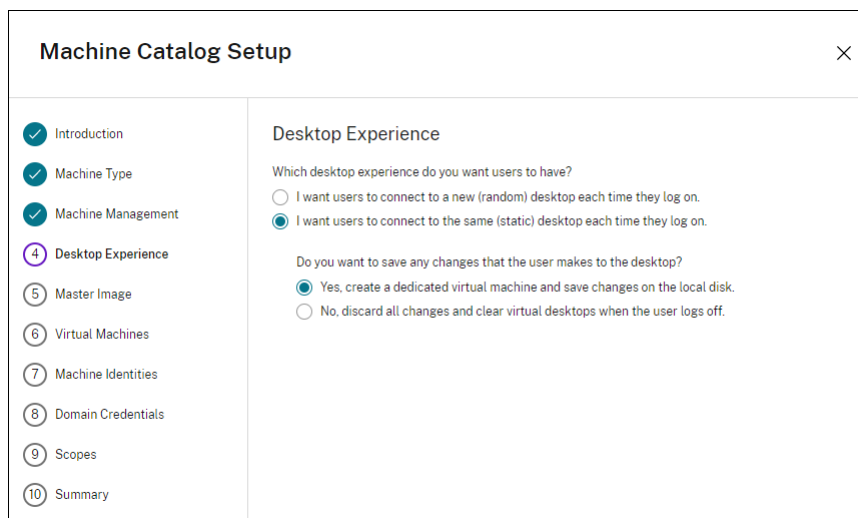

Note:

User personalization layer does not support pooled-static catalogs configured to use Citrix Personal vDisk or assigned as dedicated virtual machines.

4. If you are using MCS, select **Image** and the snapshot for the image created in the previous section.
5. Configure the remaining catalog properties as needed for your environment.

Step 4: Create a delivery group

Create and configure a **delivery group**, including machines from the machine catalog you created. For details, see the [Create Delivery Groups](#).

Step 5: Create delivery group custom policies

To enable the mounting of user layers within the Virtual Delivery Agents, you use the configuration parameters to specify:

- Where on the network to access the user layers.
- How large to permit the user layer disks to grow.

To define the parameters as custom Citrix policies in Web Studio and assign them to your delivery group.

1. Sign in to Web Studio and select **Policies** in the left pane:

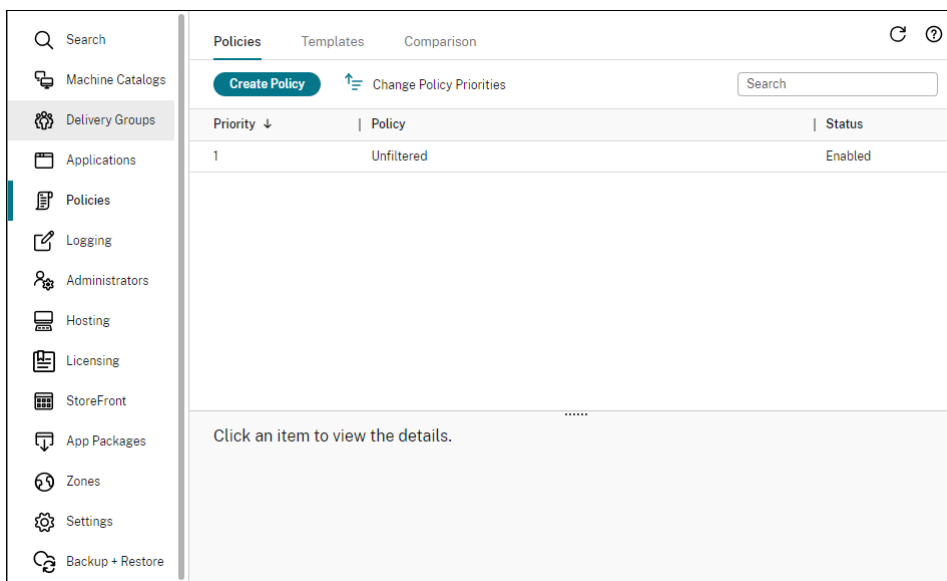

2. Select **Create Policy** in the action bar. The Create Policy window appears.
3. Type **user layer** into the search field. The following three policies appear in the list of available policies:
 - User Layer Exclusions
 - User Layer Repository Path
 - User Layer Size GB

Note:

Increasing the size affects new user layers and expands existing user layers. Decreasing the size only affects new user layers. Existing user layers never decrease in size.

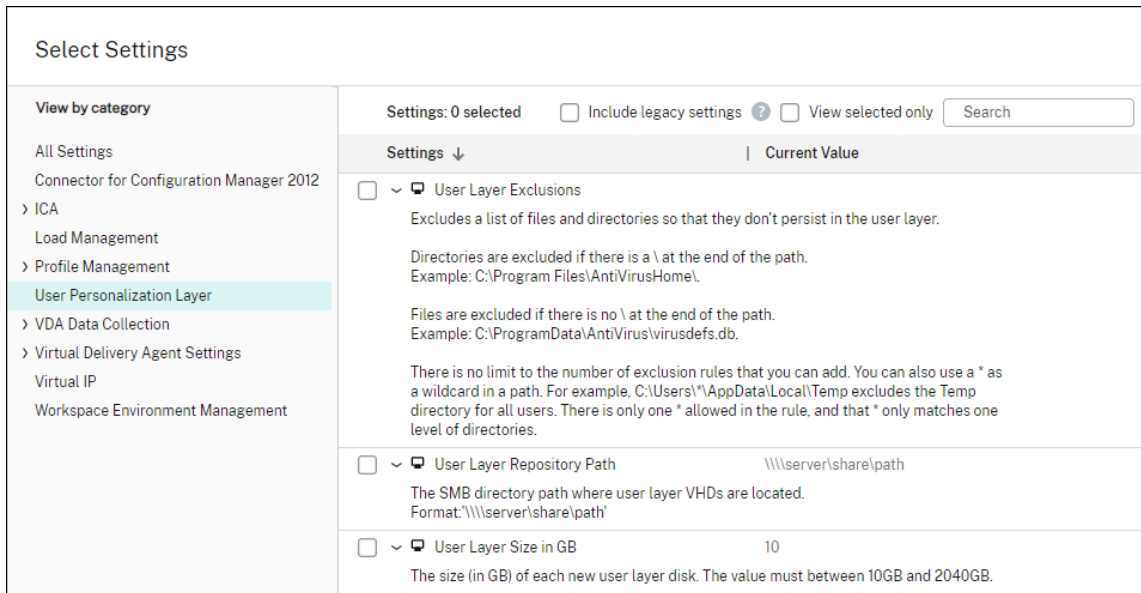

4. Mark the check box next to **User Layer Repository Path** and click **Edit**. The **Edit Setting** window appears.

5. Enter a path in the **Value** field, and click **Save**:

- **Path format:** `\\server-name-or-address\share-name\folder`
- **Path example:** `\\Server\Share\UPLUsers`
- **Resulting paths example:** For a user named **Alex** in **CoolCompanyDomain**, the path is:
`\\Server\Share\UPLUsers\Users\CoolCompanyDomain_Alex\A_OK`

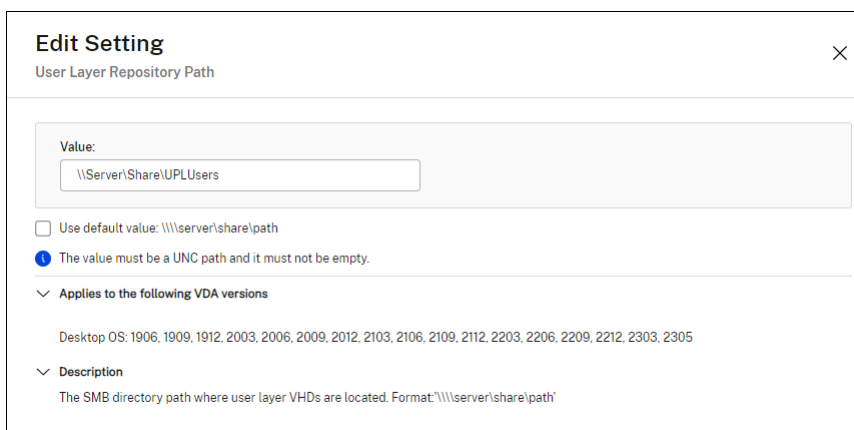

You can customize the path using the `%USERNAME%` and `%USERDOMAIN%` variables, machine environment variables, and Active Directory (AD) attributes. When expanded, these variables

result in explicit paths.

Example of environment variables:

- **Path format:** `\\Server-name-or-address\share-name\folder-with-environment-variables`
- **Path example:** `\\Server\Share\UPLUserLayers\%USERNAME%\%USERDOMAIN%\`
- **Resulting paths example:** For a user named **Alex** in **CoolCompanyDomain**, the path would be: `\\Server\Share\UPLUserLayers\Alex\CoolCompanyDomain\A_OK`

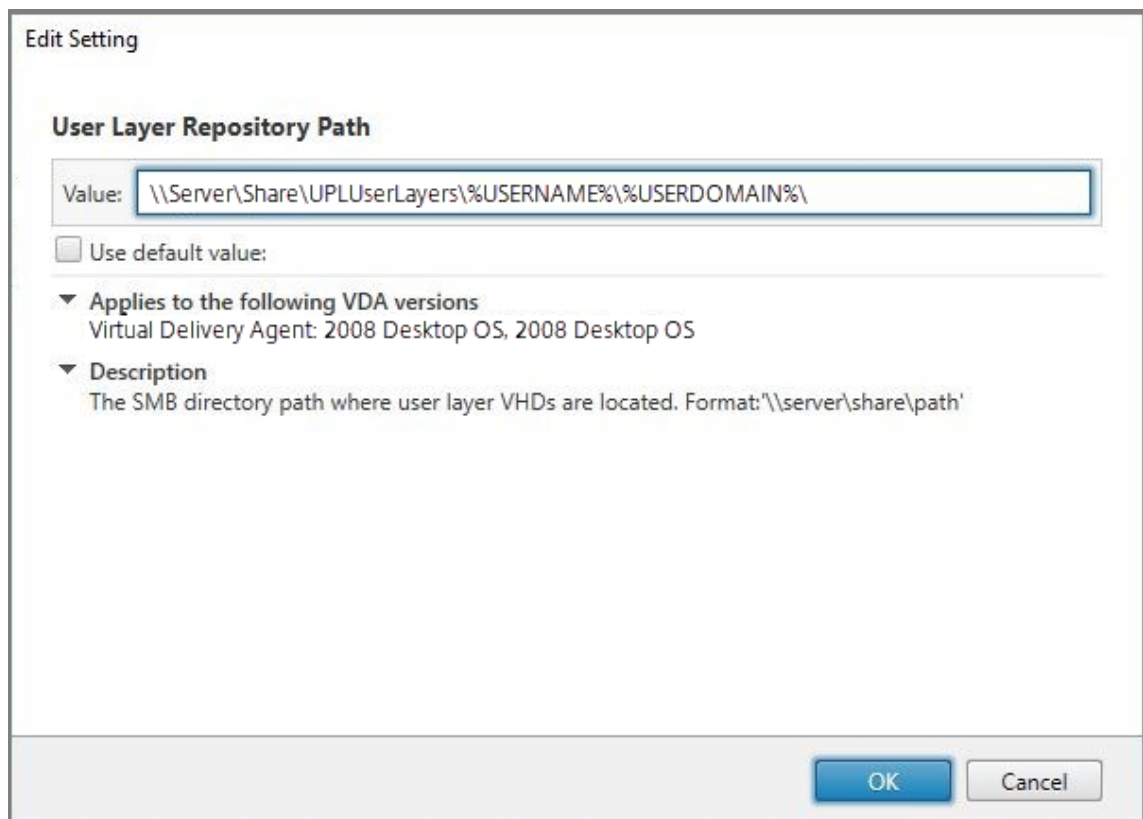

Example of custom AD attributes:

- Path format: `\\Server-name-or-address\share-name\AD-attribute`
- Path example: `\\Server\share\%#sAMAccountName%`
- Resulting paths example: `\\Server\share\JohnSmith` (if `#sAMAccountName#` resolves to `JohnSmith` for the current user)

6. Optional: Mark the check box next to **User Layer Size in GB** and click **Edit**:

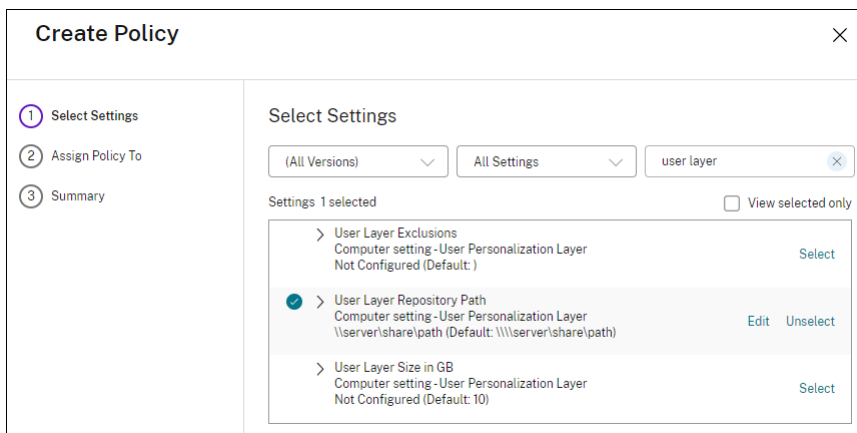

The Edit Settings window appears.

7. Optional: Change the default value of **10 GB** to the maximum size that each user layer can grow. Click **Save**.
8. Optional: Mark the check box next to **User Layer Exclusions** and click **Edit**.

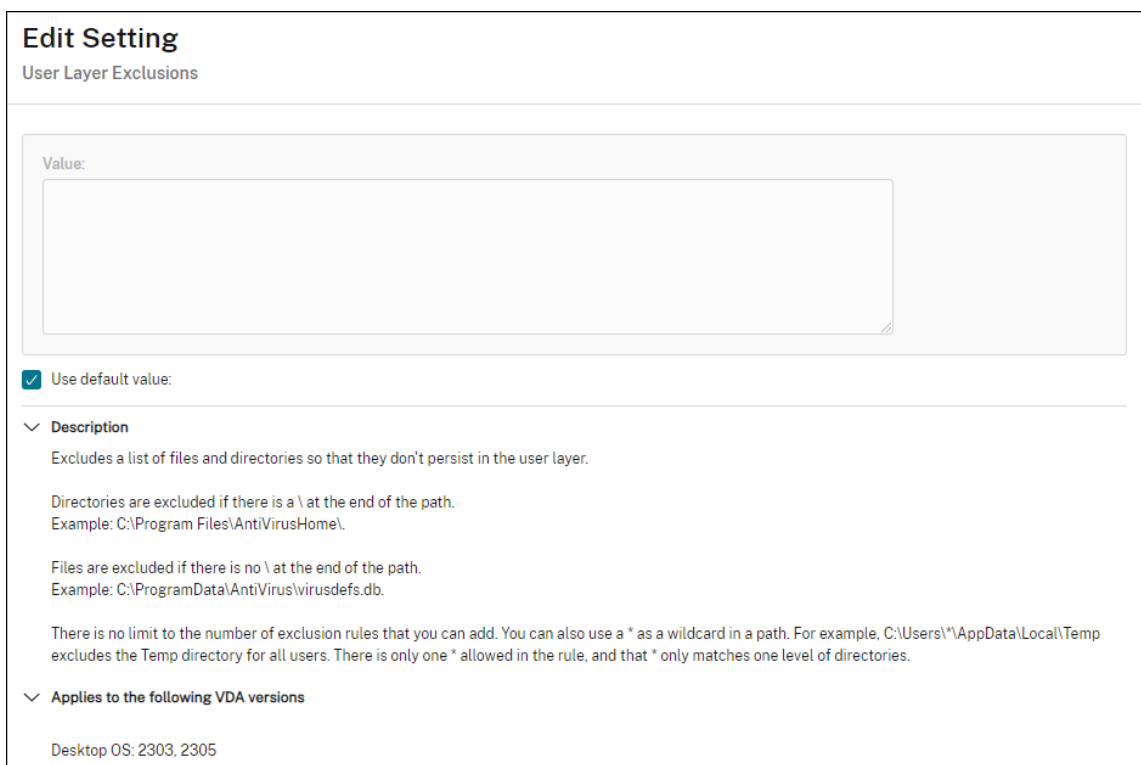

9. Optional: Specify the files and folders to exclude, then click **Save**. For more information, see the [Citrix App Layering documentation](#).
10. Click **Next** to configure the users and machines to which you want to assign. Click the **Delivery Group Assign** link highlighted in this image:

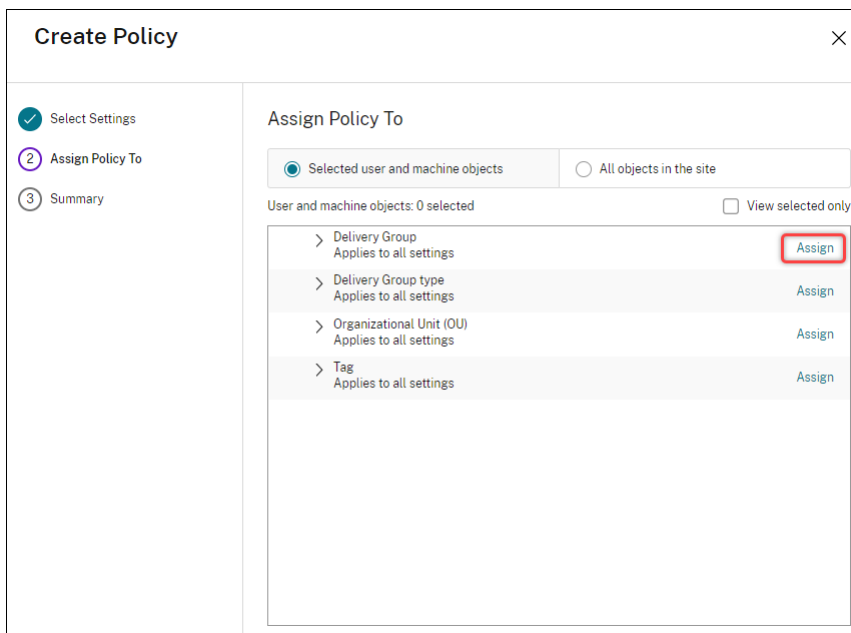

11. In the **Delivery Group** menu, select the delivery group created in the previous section. Click **OK**.

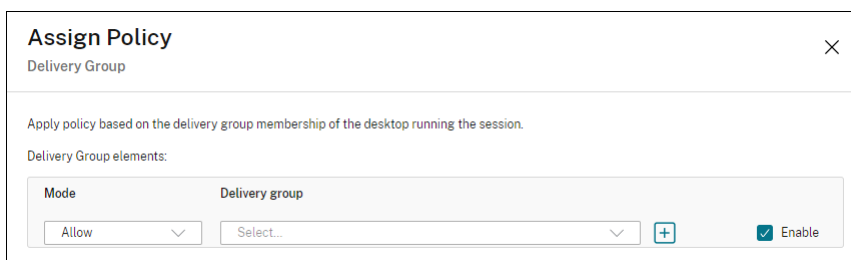

12. Enter a name for the policy. Click the check box to enable the policy, and click **Finish**.

Configure security settings on the user layer folder

As a domain administrator, you can specify more than one storage location for your user layers. Create a `\Users` subfolder for each storage location (including the default location). Secure each location using the following settings.

| Setting name | Value | Apply to |
|--|----------------|--|
| Creator Owner | Modify | Subfolders and Files only |
| Owner Rights | Modify | Subfolders and Files only |
| | Users or group | Create Folder/Append Data;
Traverse Folder/Execute File;
List Folder/Read Data; Read
Attributes |
| System | Full Control | Selected Folder, Subfolders,
and Files |
| Domain Admins, and selected
Admin group | Full Control | Selected Folder, Subfolders,
and Files |

User layer messages

When a user is unable to access their user layer, they receive one of these notification messages.

- **User Layer In Use**

We were unable to attach your user layer because it is in use. Any changes you make to application settings or data will not be saved. Be sure to save any work to a shared network location.<!--NeedCopy-->

- **User Layer Unavailable**

We were unable to attach your user layer. Any changes you make to application settings or data will not be saved. Be sure to save any work to a shared network location.<!--NeedCopy-->

- **System not reset after user sign-out**

This system was not shut down properly. Please log off immediately and contact your system administrator.<!--NeedCopy-->

Log files to use when troubleshooting

The log file, `ulayersvc.log`, contains the output of the user personalization layer software where changes are logged.

```
1 C:\ProgramData\Unidesk\Logs\ulayersvc.log
2 <!--NeedCopy-->
```

User Layer/UPL space reclamation

You can use **User Layer/UPL space reclamation** to automatically compress the VHDX files every time the user logs off.

For more information, see [User Layer/UPL space reclamation](#)

Limitations

Keep the following limitations in mind when installing and using the user personalization layer feature.

- Do *not* attempt to deploy the user personalization layer software on a layer within App Layering. Either deploy user personalization layers in Citrix Virtual Apps and Desktops or enable user layers in an App Layering image template, not both. Either process produces the user layers that you need.
- Do *not* configure the user personalization layer feature with persistent machine catalogs.

- Do *not* use Session hosts.
- Do *not* update the machine catalog with an image running a new OS install (even the same version of Windows 10). The best practice is to apply updates to the OS within the same master image used when creating the machine catalog.
- Do *not* use boot-time drivers or any other early boot personalization.
- Do *not* migrate PvD data to the user personalization layer feature.
- Do *not* migrate existing user layers from the full App Layering product to the user personalization layer feature.
- Do *not* change the user layer SMB path to access user layers created using a different master OS image.

- When a user logs out of a session and then logs in again, the new session runs on a different machine in the pool. In a VDI environment, Microsoft Software Center lists an application as **Installed** on the first machine but shows it as **Unavailable** on the second machine.

To find out the true status of the application, instruct the user to select the application in the Software Center and click **Install**. SCCM then updates the status to the true value.

- Software Center occasionally stops immediately after launching within a VDA that has the user personalization layer feature enabled. To avoid this issue, follow Microsoft's recommendations for [Implementing SCCM in a XenDesktop VDI environment](#). Also, make sure that the `ccmexec` service is running before you start the Software Center.
- In Group Policies (Computer Settings), User layer settings override settings applied to the master image. Therefore, the changes you make in Computer Settings using a GPO are not always present for the user on the next session login.

To get around this issue, create a User Logon Script that issues the command:

```
gpupdate /force
```

For example, one customer set the following command to run at each user login:

```
gpupdate /Target:Computer /force
```

For best results, apply changes to Computer Settings directly on the user layer, after the user has logged in.

- A domain user account must not be the last user to have logged in to a master image. Otherwise, the machines provisioned from that image might have issues.
- Custom certificates do not persist when UPL is enabled in a pure Azure AD environment, due to an underlying issue in Windows running on Azure. If Microsoft fixes this issue in a future enhancement, we will update this article.

Remove components

April 6, 2023

To remove components, Citrix recommends using the Windows feature for removing or changing programs. Alternatively, you can remove components using the command line, or a script on the installation media.

When you remove components, prerequisites are not removed, and firewall settings are not changed. For example, when you remove a Delivery Controller, the SQL Server software and the databases are not removed.

If you upgraded a Controller from an earlier deployment that included Web Interface, you must remove the Web Interface component separately. You cannot use the installer to remove Web Interface.

For information about removing features not mentioned below, see the feature's documentation.

Preparation

Before removing a Controller, remove it from the site. For details, see [Remove a Controller](#).

Close Studio and Director before removing them.

Remove components using the Windows feature for removing or changing programs

From the Windows feature for removing or changing programs:

- To remove a Controller, Studio, Director, License Server, or StoreFront, right-click **Citrix Virtual Apps *version*** or **Citrix Virtual Apps and Desktops *version*** and select **Uninstall**. The installer launches. Select the components to be removed.

Alternatively, you can remove StoreFront by right-clicking **Citrix StoreFront** and selecting **Uninstall**.

- To remove a VDA, right-click **Citrix Virtual Delivery Agent *version*** and select **Uninstall**. The installer launches and you can select the components to be removed. The machine restarts automatically after the removal, by default.
- To remove the Universal Print Server, right-click **Citrix Universal Print Server** and select **Uninstall**.

Remove core components using the command line

From the `\x64\XenDesktop Setup` directory, run the `XenDesktopServerSetup.exe` command.

- To remove one or more components, specify the `/remove` and `/components` options.
- To remove all components, specify the `/removeall` option.

For command and parameter details, see [Install using the command line](#).

For example, the following command removes Web Studio.

```
\x64\XenDesktop Setup\XenDesktopServerSetup.exe /remove /components webstudio
```

Remove VDAs using the command line

From the `\x64\XenDesktop Setup` directory, run the `XenDesktopVdaSetup.exe` command.

- To remove one or more components, use the `/remove` and `/components` options. For example, to remove the VDA and Citrix Workspace app, use `/remove /components vda, plugin`.
- The `/removeall` option removes only the VDA. It does not remove the Citrix Workspace app.

For command and parameter details, see [Install using the command line](#).

The machine restarts automatically after the removal, by default.

To remove VDAs using a script in Active Directory, see [Install or remove VDAs using scripts](#).

Upgrade and migrate

February 12, 2024

Introduction

Upgrading changes your deployment to the Citrix Virtual Apps and Desktops 7 [Current Release \(CR\)](#) without having to set up new machines or sites. This is known as an in-place upgrade.

Upgrading gives you access to the latest features and technologies that you're eligible for. Upgrades can also contain fixes, clarifications, and enhancements from earlier versions.

Upgrade overview

1. Review the [Upgrade a deployment](#) article before beginning the upgrade. This is the primary information source for learning how to prepare for and implement an upgrade.
2. Ensure that your current Customer Success Services dates are valid and have not expired. For more information, see the [Customer Success Services renewal licenses](#) article.
3. Complete the preparation guidance.
4. Run installers to upgrade core components.
5. Upgrade the system databases and the site.
6. Upgrade VDAs on images (or directly on machines).
7. Upgrade other components.

Each preparation and upgrade step is detailed in [Upgrade a deployment](#).

Versions you can upgrade

You can upgrade to Citrix Virtual Apps and Desktops 2203 LTSR from:

- Virtual Apps and Desktops 1912 with or without CUs, up to and including CU5
- Currently supported CR versions of Citrix Virtual Apps and Desktops

You can also refer to the [Citrix Upgrade Guide](#) for a list of the Citrix Virtual Apps and Desktops (and XenApp and XenDesktop) versions you can upgrade from.

Frequently asked questions

This section answers some commonly asked questions about upgrading Citrix Virtual Apps and Desktops.

- **What is the correct order to upgrade my Virtual Apps and Desktops environment?**

For an illustration and description of the recommended upgrade sequence, see [Upgrade sequence](#) and [Upgrade procedure](#).

- **My site has several Delivery Controllers (in different zones). What happens if I upgrade only some of them? Am I required to upgrade every Controller in the site during the same maintenance window?**

The best practice is to upgrade all Delivery Controllers during the same maintenance window, as various services on each Controller communicate with each other. Keeping different versions might cause issues. During a maintenance window, we recommend you upgrade half of the Controllers, upgrade the site, and then upgrade the remaining Controllers. (For details, see the [Upgrade procedure](#).)

- **Can I go directly to the latest version, or do I have to do incremental upgrades?**

You can almost always upgrade to the latest version and skip intermediate releases, unless explicitly stated in the **What's new** article for the version you're upgrading to. See the [Upgrade Guide](#).

- **Can a customer upgrade from a Long Term Service Release (LTSR) environment to a Current Release?**

Yes. Customers are not required to remain on a Long Term Service Release for an extended period. Customers can move an LTSR environment to a Current Release, based on business requirements and features.

- **Are mixed versions of components allowed?**

Within each site, Citrix recommends upgrading all components to the same version. Although you can use earlier versions of some components, all features in the latest version might not be available. For more information, see [Mixed environment considerations](#).

- **How often must a Current Release be upgraded?**

Current Releases reach End of Maintenance (EOM) 6 months after the release date. Citrix recommends that customers adopt the latest Current Release. Current Releases reach End of Life (EOL) 18 months after the release date. For more information, see [Current Release Lifecycle](#).

- **What is recommended: upgrade to LTSR or CR?**

Current Releases (CRs) deliver the latest and most innovative app, desktop, and server virtualization features and functionality. This allows you to stay on leading-edge technology and ahead of your competition.

Long Term Service Releases (LTSRs) are ideal for large enterprise production environments that prefer to retain the same base version for an extended period.

For details, see [Servicing Options](#).

- **Do I need to upgrade my licenses?**

Ensure that the current license date has not expired, and is valid for the release you are upgrading to. See [CTX111618](#). For information about renewal, see [Customer Success Services renewal licenses](#).

- **How long does an upgrade take?**

The time required to upgrade a deployment varies, depending on the infrastructure and network. So, we can't provide an exact time.

- **What are the best practices?**

Ensure that you understand and follow the [preparation guidance](#).

- **Which operating systems are supported?**

The [System requirements](#) article for the version you're upgrading to lists the supported OSs.

If your current deployment uses operating systems that are no longer supported, see [Earlier operating systems](#).

- **Which versions of VMware vSphere (vCenter + ESXi) are supported?**

[CTX131239](#) lists the supported hosts and versions, plus links to known issues.

- **When does my version go EOL?**

Check the [Product Matrix](#).

- **What are the known issues with the latest release?**

- [Citrix Virtual Apps and Desktops](#)
- [StoreFront](#)
- [Citrix Provisioning](#)
- [Citrix License Server](#)
- [Citrix Workspace app for Windows](#)

More information

[Long Term Service Release \(LTSR\)](#) deployment updates use Cumulative Updates (CUs). A CU updates baseline components of the LTSR, and each CU includes its own metainstaller.

Each CU has dedicated documentation. For example, for the 2203 LTSR, check the link on that LTSR's **What's new** page for the latest CU. Each CU page includes supported version information, instructions, and a link to the CU download package.

Migrate

Migrate to the cloud

You can use the Automated Configuration tool for Citrix Virtual Apps and Desktops to migrate your on-premises deployment onto the cloud. For more information, see [Migrate to Cloud](#).

Legacy migration

Migrating moves data from an earlier deployment to a newer version. The process includes installing newer components and creating a new site, exporting data from the older farm, and then importing the data to the new site.

There are no supported tools or scripts for migrating XenApp and XenDesktop versions, or migrating earlier Citrix Virtual Apps and Desktops versions. *Upgrading* is supported for the Citrix Virtual Apps and Desktops versions listed in the [Citrix Upgrade Guide](#), and described in this product documentation.

For earlier XenApp 6.x migration content, see the following. Neither the scripts nor the articles are supported or maintained.

- Open source migration scripts for XenApp 6.x versions are available at <https://github.com/citrix/xa65migrationtool>. Citrix does not support or maintain these migration scripts
- [Changes in 7.x](#)
- [Upgrade a XenApp 6.5 worker to a new VDA](#)
- [Migrate XenApp 6.x](#)

Upgrade a deployment

April 10, 2024

Introduction

You can upgrade certain deployments to newer versions without having to first set up new machines or sites. This is called an in-place upgrade. To learn which Citrix Virtual Apps and Desktops versions you can upgrade, see the [Citrix Upgrade Guide](#).

Before you upgrade to any of the Citrix Virtual Apps and Desktops releases, ensure that your current Customer Success Services dates are valid and have not expired. For more information, see the [Customer Success Services renewal licenses](#) article.

To start an upgrade, you run the installer from the new version to upgrade previously installed core components, VDAs, and certain other components. Then you upgrade the databases and the site.

You can upgrade any component that can be installed with the full-product installer (and the stand-alone VDA installers), if there is a newer version provided. For other components that are not installed with the full-product installer (such as Citrix Provisioning and Profile Management), see that component's documentation for guidance. For host upgrades, see the appropriate documentation.

Review all the information in this article before beginning an upgrade.

Upgrade sequence

The following diagram shows the steps the upgrade sequence. Upgrade procedure contains details of each step in the diagram.

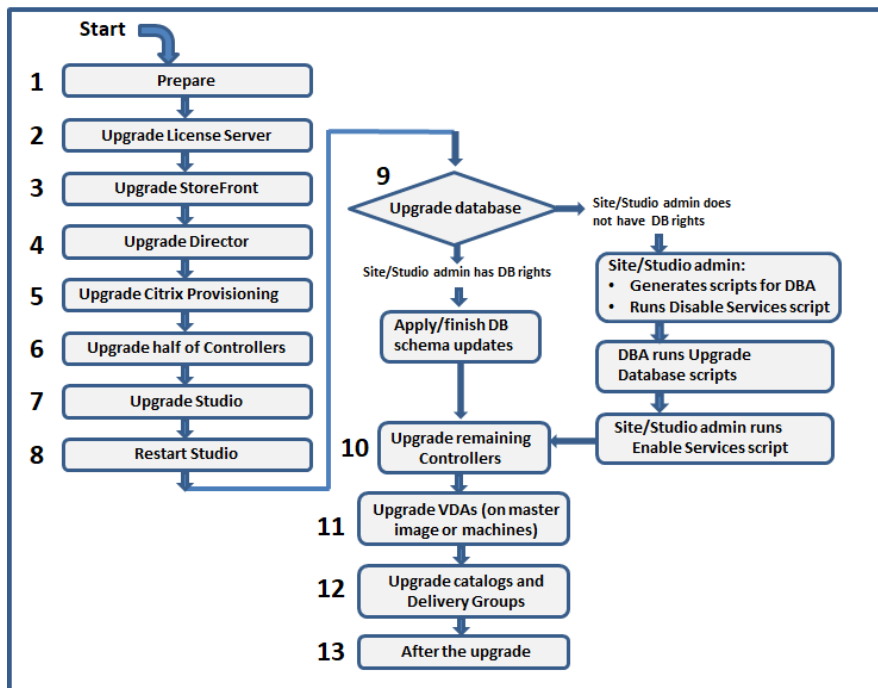

Note:

To avoid failures, you must upgrade all Delivery Controllers and database before performing any of the provisioning and delivery group related tasks such as creating a new machine catalog, deleting a machine catalog, updating a machine in a delivery group, and so on.

Hybrid Rights Licenses

Hybrid Rights licenses are term-based subscription licenses that are provided, in addition to the cloud service subscription, when a customer transitions or trades up from a perpetual license to a cloud service subscription. You can also purchase a Hybrid Rights add-on with your DaaS subscriptions.

If you have a Hybrid Rights license with a SaaS attribute, when you upgrade to Citrix Virtual Apps and Desktops LTSR 2203 and later, you become eligible to access capabilities not available with Citrix Virtual Apps and Desktops LTSR 1912. These capabilities include provisioning and hosting workloads in public clouds, such as Microsoft Azure, AWS EC2, and Google Cloud. Before deploying the new license file, update your License Server to the most recent version.

If you have access to a Hybrid Rights license with no SaaS attribute, follow these steps to get access to the new Hybrid Rights license with SaaS attribute:

Note:

- You get an email with a new license code. For more information see, [Use license access code](#).

- Your existing licenses are rescinded. Rescinded licenses must be deleted from License Servers followed by new license installation. For more information, see [Deleting license files](#).

1. Go to citrix.com Manage Licenses portal and download the new Hybrid Rights license file with cloud provisioning rights enabled (SaaS attribute). For more information, see [Download licenses](#). The following image shows the Hybrid Rights license file with SaaS attribute in the Increments section.

```
INCREMENT XDT_PLT_CCS CITRIX 2022.1201 01-dec-2022 5 \  
VENDOR_STRING=;LT=RetailS;GP=720;PSL=10;CL=VDS,VDA,VDE,VDP,SaaS;SA=0;ODP=0;NUDURMIN=2880;NUDURMAX=525600;AP=ADMIN/INT/14  
OVERDRAFT=1 DUP_GROUP=V ISSUED=18-dec-2005 NOTICE="Citrix \  
Systems Inc." SN=RetailSSaaS SIGN="..."
```

2. Install the Hybrid Rights license file on the License Server. For more information, see [Install licenses](#).
3. If there is a change in license editions or model, make sure you run the broker command to set the edition and the model and then start the in-place upgrade. For more information about Broker commands, see [Broker PowerShell SDK](#) section.

For more information about public cloud support with Citrix Virtual Apps and Desktops Current Releases and Long Term Service Releases, see [CTX270373](#).

Upgrade procedure

Most of the main product components can be upgraded by running the product installer on the machine containing the component.

If one machine contains more than one component (for example, Studio and License Server), all components on that machine are upgraded, if the product media contains newer versions of their software.

To use the installers:

- To run the full product installer's graphical interface, log on to the machine and then insert the media or mount the ISO drive for the new release. Double-click **AutoSelect**.
- To use the command-line interface, issue the appropriate command. See [Install using the command line](#).

Step 1: Prepare

Before you begin an upgrade, make sure you're ready. Read and complete any necessary tasks:

- Remove PVD, AppDisks, and unsupported hosts

- VDAs that have PvD or AppDisk components
- Limitations
- Mixed environment considerations
- Earlier operating systems
- Preparation
- Preliminary site tests
- SQL Server version check

Step 2: Upgrade License Server

If the installation has a new version of the Citrix License Server software, upgrade this component first before any other components.

If you have not yet determined whether your License Server is compatible with the new version, it is essential that you run the installer on the License Server before upgrading any other core components.

Step 3: Upgrade StoreFront

If the installation media contains a new version of the StoreFront software, run the installer on the machine containing the StoreFront server.

- In the graphical interface, choose **Citrix StoreFront** from the **Extend deployment** section.
- From the command line, run `CitrixStoreFront-x64.exe`, which is available in the Citrix Virtual Apps and Desktops installation media's `x64` folder.

Step 4: Upgrade Director

If the installation media contains a new version of the Director software, run the installer on the machine containing Director.

Step 5: Upgrade Citrix Provisioning

The Citrix Provisioning installation media is available separately from the Citrix Virtual Apps and Desktops installation media. To learn how to install and upgrade Citrix Provisioning server and target device software, see the [Citrix Provisioning product documentation](#).

Step 6: Upgrade half of Delivery Controllers

For example, if your site has four Controllers, run the installer on two of them.

Leaving half of the Controllers active allows users to access the site. VDAs can register with the remaining Controllers. There might be times when the site has reduced capacity because fewer Controllers are available. The upgrade causes only a brief interruption in establishing new client connections during the final database upgrade steps. The upgraded Controllers cannot process requests until the entire site is upgraded.

If your site has only one Controller, it is inoperable during the upgrade.

Preliminary site tests run on the first Controller, before the actual upgrade starts. For details, see Preliminary site tests.

Step 7: Upgrade Studio

If you haven't already upgraded Web Studio (because it was on the same machine as another component), run the installer on the machine containing Studio.

Note:

After you upgrade Web Studio, the version information might not update immediately. You might be prompted to upgrade Web Studio even though it's already up to date. To address the issue, go to the Web Studio server, open Internet Information Services (IIS) Manager, navigate to Start Page > Sites > Default Web Site, and select **Restart** in the Manage Website pane.

Step 8: Restart Studio

Restart the upgraded Web Studio. The upgrade process automatically resumes.

Step 9: Upgrade database and site

Note:

To avoid failures, you must upgrade all Delivery Controllers and database before performing any of the provisioning and delivery group related tasks such as creating a new machine catalog, deleting a machine catalog, updating a machine in a delivery group, and so on.

Check Preparation for the permissions required to update the schema of the SQL Server databases.

- If you have sufficient permission to update the SQL Server database schema, you can initiate an automatic database upgrade. Continue with Upgrade the database and site automatically.

- If you do not have sufficient database permissions, you can initiate a manual upgrade that uses scripts, and proceed with the help of your database administrator (someone who has the required permissions). For a manual upgrade, the Studio user generates the scripts and then runs the scripts that enable and disable services. The database administrator runs other scripts that update the database schema, using either the SQLCMD utility or the SQL Server Management Studio in SQLCMD mode. Continue with Upgrade the database and site manually.
- If you have a multi-zone deployment and want to upgrade the database and site automatically, Citrix recommends that the dbschema upgrade should be performed in the same zone that hosts the SQL server databases of the site. Otherwise, upgrading the database and site automatically might fail.

Citrix strongly recommends that you back up the database before upgrading. See CTX135207. During a database upgrade, product services are disabled. During that time, Controllers cannot broker new connections for the site, so plan carefully.

Upgrade the database and site automatically

1. Start the newly upgraded Studio.
2. Indicate that you want to start the site upgrade automatically and confirm that you are ready.

The database and site upgrade proceeds.

Upgrade the database and site manually

1. Start the newly upgraded Studio.
2. Indicate that you want to upgrade the site manually. The wizard checks for License Server compatibility and requests confirmation.
3. Confirm that you have backed up the database.

The wizard generates and displays the scripts and a checklist of upgrade steps. If a database's schema has not changed since the product version being upgraded, that script is not generated. For example, if the logging database schema does not change, the `UpgradeLoggingDatabase.sql` script is not generated.

4. Run the following scripts in the order shown.
 - `DisableServices.ps1`: The Studio user runs this PowerShell script on a Controller to disable product services.
 - `UpgradeSiteDatabase.sql`: The database administrator runs this SQL script on the server containing the Site database
 - `UpgradeMonitorDatabase.sql`: The database administrator runs this SQL script on the server containing the Monitor database.

- [UpgradeLoggingDatabase.sql](#): The database administrator runs this SQL script on the server containing the Configuration Logging database. Run this script only if this database changes (for example, after applying a hotfix).
- [EnableServices.ps1](#): The Studio user runs this PowerShell script on a Controller to enable product services.

After the database upgrade completes and product services are enabled, Studio automatically tests the environment and configuration, and then generates an HTML report. If problems are identified, you can restore the database backup. After resolving issues, you can upgrade the database again.

5. After completing the checklist tasks, click **Finish upgrade**.

Step 10: Upgrade remaining Delivery Controllers

From the newly upgraded Studio, select **Citrix Studio** *site-name* in the navigation pane. On the **Common Tasks** tab, select **Upgrade remaining Delivery Controllers**.

Note:

To make **Upgrade remaining Delivery Controllers** available, create at least one machine catalog and one delivery group for the site.

After completing the upgrade and confirming completion, close and then reopen Studio. Studio might prompt for an extra site upgrade to register the Controller's services to the site, or to create a zone ID if it does not exist.

Step 11: Upgrade VDAs

Important:

If you're upgrading a VDA to version 1912 or later, see [Upgrading VDAs to 1912 or later](#).

Run the product installer on machines containing VDAs.

If you used Machine Creation Services and a master image to create machines, go to your host and upgrade the VDA on the master image. You can use any of the available VDA installers.

- For graphic interface guidance, see [Install VDAs](#).
- For command line guidance, see [Install using the command line](#).

If you used Citrix Provisioning to create machines, see the [Citrix Provisioning product documentation](#) for guidance about upgrading.

Step 12: Update machine catalogs and Delivery Groups

- [Update catalogs that use machines with upgraded VDAs.](#)
- [Upgrade catalogs that use machines with upgraded VDAs.](#)
- [Upgrade Delivery Groups that use machines with upgraded VDAs.](#)

Step 13: After the upgrade

After completing an upgrade, you can test the newly upgraded site. From Studio, select **Citrix Studio site-name** in the navigation pane. On the **Common Tasks** tab, select **Test Site**. These tests run automatically after you upgrade the database, but you can run them again at any time.

The tests might fail for a Controller on Windows Server 2016 when a local Microsoft SQL Server Express is used for the site database, if the SQL Server Browser Service is not started. To avoid this:

- Enable the SQL Server Browser Service (if necessary) and then start it.
- Restart the SQL Server (SQLEXPRESS) service.

Upgrade other components in your deployment. For guidance, see the following product documentation:

- [StoreFront](#)
- [AppDNA](#)
- [Citrix App Layering](#)
- [HDX RealTime Optimization Pack](#)
- [Profile Management](#)
- [Citrix Provisioning](#)
- [Session Recording](#)
- [Workspace Environment Management](#)

If you need to replace the Microsoft SQL Server Express LocalDB software with a later version, see [Replace SQL Server Express LocalDB](#).

Dbschema upgrade

When you update your deployment, several database schemas can be upgraded. The following table lists which database schemas are upgraded in the process:

| From\To | 1912 CU1 | 1912 CU2 | 1912 CU3 | 1912 CU4 | 1912 CU5 | 2209 |
|------------------------------|-----------------------|-----------------------|-----------------------|-----------------------|-----------------------|--------------------------------|
| 7.15 RTM or 7.15 CU releases | Site; Monitor; Config | Site; Monitor; Config | Site; Monitor; Config | Site; Monitor; Config | Site; Monitor; Config | Site; Monitor; Config; Logging |
| 1912 RTM | Config | Site, Config | Site, Config | Site; Monitor; Config | Site; Monitor; Config | Site; Monitor; Config; Logging |
| 1912 CU1 | | Site | Site, Config | Site; Monitor; Config | Site; Monitor; Config | Site; Monitor; Config; Logging |
| 1912 CU2 | | | Site, Config | Site; Monitor; Config | Site; Monitor; Config | Site; Monitor; Config; Logging |
| 1912 CU3 | | | | Site; Monitor; Config | Site; Monitor; Config | Site; Monitor; Config; Logging |
| 1912 CU4 | | | | | Site, Config | Site; Monitor; Config; Logging |
| 1912 CU5 | | | | | | Site; Monitor; Config; Logging |
| 2112 | | | | | | Site; Monitor; Config |

Definition of terms:

- Site: Site Datastore. Dbschema update is made to the Site Datastore.
- Monitor: Monitor Datastore. Dbschema update is made to the Monitor Datastore.
- Config: Configuration table. Desktop Studio version, Licensing information, or both are updated in the Configuration table.
- Logging: Logging Datastore. Dbschema update is made to the Logging Datastore.

Upgrade VDAs to 2203 or later

If the Personal vDisk (PvD) component was ever installed on a VDA, that VDA cannot be upgraded to version 2203 or later. To use the new VDA, you must uninstall the current VDA and then install the new VDA.

This instruction applies even if you never used PvD.

Here's how the PvD component might have been installed in earlier versions:

- In the VDA installer's graphical interface, PvD was an option on the **Additional Components** page.
- On the command line, the `/baseimage` option installed PvD. If you specified this option, or used a script that contained this option, PvD was installed.

If you don't know whether your VDA has PvD installed, run the installer for the new VDA (2203 or later) on the machine or image.

- If PvD is installed, a message appears, indicating there is an incompatible component.
 - From the graphical interface, click **Cancel** on the page containing the message, and then confirm that you want to close the installer.
 - From the CLI, the command simply fails with the displayed message.
- If PvD is not installed, the upgrade proceeds.

What to do

If the VDA does not have PvD installed, follow the usual upgrade procedure.

If the VDA has PvD installed:

1. Uninstall the current VDA.
2. Install the new VDA.

If you want to continue using PvD on your Windows 10 (1607 and earlier, without updates) machines, VDA 7.15 LTSR is the latest supported version.

Note:

Can I use Personal vDisk with Windows 7 desktops in XenApp and XenDesktop 7.15 LTSR?

Citrix excluded Personal vDisk (PvD) from XenApp and XenDesktop 7.6 LTSR which was announced in January 2016. Additionally, Citrix has announced the deprecation of the PvD technology and recommends that customers start using Citrix App Layering going forward. Citrix App Layering (version 4.4 and later) is a compatible component of XenApp and XenDesktop 7.15 LTSR. However, to help customers with existing PvD deployments on Windows 7 migrate to Citrix App Layering technology, Citrix has decided to provide limited time support for PvD deployments for Windows 7 desktops through XenApp and XenDesktop 7.15 LTSR Cumulative Updates (CUs) until Jan 14, 2020. The PvD component will be removed from LTSR CUs and not supported after Jan 14, 2020. Additionally, use of PvD for Windows 7 beyond Jan 14, 2020 will render LTSR sites non-compliant. Also, PvD for Windows 10 continues to be excluded from 7.15 LTSR. Therefore, customers should not use it with their 7.15 LTSR sites.

Remove PvD, AppDisks, and unsupported hosts

The following technologies and host types are not supported in Citrix Virtual Apps and Desktops 7 Current Release deployments:

- **Personal vDisks (PvD)** for storing data next to users' VMs in catalogs. The user personalization layer feature now handles user persistence.
- **AppDisks** for managing applications used in Delivery Groups.
- **Host types:** Azure Classic, CloudPlatform (the original Citrix product).
 - For host types supported in this release, see [System requirements](#).
 - For information about alternative ways you can continue using ARM and AWS, see [CTX270373](#).

If your current deployment uses PvDs or AppDisks, or has connections to unsupported host types (for example, Microsoft Azure Classic), you can upgrade to version 2006 (or later supported versions) only after removing items that use those technologies. If your current deployment uses public cloud host connections (for example, AWS), ensure that you have Hybrid Rights License before upgrading. When the installer detects one or more of the unsupported technologies or host connections without Hybrid Rights License, the upgrade pauses or stops, and an explanatory message appears. The installer logs contain details.

To help ensure a successful upgrade, review and follow the applicable guidance for removing the unsupported items.

- Remove PvD
- Remove AppDisks

- Remove unsupported host items

Even if you did not use PvD or AppDisks in your deployment, related MSIs might have been included in an earlier VDA installation or upgrade. Before you can upgrade your VDAs to version 2006 (or a later supported version), you must remove that software, even if you never used it. When using the graphical interface, that removal can be done for you, or you can include removal options when using the CLI. For details, see [Upgrading VDAs that have PvD or AppDisks components](#).

Remove PvD

A deployment upgrade cannot succeed until you remove all machines that are configured to use PvD. This affects catalogs and Delivery Groups.

To remove PvD from groups and catalogs:

1. From Studio, if a Delivery Group contains machines from a catalog that uses PvD, [remove those machines from the group](#).
2. From Studio, [delete all catalogs](#) containing machines that use PvD.

VDA upgrades: The deployment upgrade does not detect whether VDAs have the AppDisk or PvD components installed. However, the VDA installers do. For details, see [VDAs that have PvD or AppDisks components](#).

If you plan to use App Layering instead of PvD, see [Migrating PvD to App Layering](#) for information about moving data.

Remove AppDisks

A deployment upgrade cannot proceed until you remove AppDisks from all Delivery Groups that use them, and then remove the AppDisks themselves.

1. Select **Delivery Groups** in the Studio navigation pane.
2. Select a group and then click **Manage AppDisks** in the Action pane.
3. Click the action that removes the AppDisk from the group.
4. Repeat steps 2 and 3 for each Delivery Group that uses AppDisks.
5. Select **AppDisks** in the Studio navigation pane.
6. Select an AppDisk and click the action that deletes the AppDisk.
7. Repeat steps 5 and 6 for each AppDisk.

VDA upgrades: The deployment upgrade does not detect whether VDAs have the AppDisk or PvD components installed. However, the VDA installers do. For details, see [VDAs that have PvD or AppDisks components](#).

Remove unsupported host items

A deployment upgrade to version 2006 (or later supported version) cannot proceed if the site has connections to unsupported host types, such as Citrix CloudPlatform or Microsoft Azure Classic. Complete the following tasks before attempting an upgrade.

From Studio:

- [Delete all connections](#) to unsupported hosts.
- If a Delivery Group contains machines from a catalog created with a master image from an unsupported host, [remove those machines from the group](#).
- [Delete all catalogs](#) that were created using a master image from an unsupported host.

VDAs that have PvD or AppDisks components

If the components that enable PvD and AppDisks technologies are installed on a VDA, that VDA cannot be upgraded until those components are removed.

Note:

When upgrading to version 1912, you had to uninstall the current VDA and then install the new VDA. In this version, you're asked if you want Citrix to remove the component and then continue the upgrade.

The AppDisk and PvD components might have been installed in earlier VDA versions, even if you never used those technologies:

- Graphical interface: In the VDA installers, the **Additional Components** page contained the **Citrix AppDisk / Personal vDisk** option. The 7.15 LTSR and earlier 7.x releases enabled this option by default. So, if you accepted the defaults (or explicitly enabled the option in any release that offered it), that component was installed.
- CLI: Specifying the `/base image` option installed the component.

What to do If the VDA installer does not detect the AppDisks or PvD components in the currently installed VDA, the upgrade proceeds as usual.

If the installer detects AppDisks or PvD components in the currently installed VDA:

- Graphical interface: The upgrade pauses. A message asks if you want the unsupported components removed automatically. If you click **OK**, the components are removed automatically and the upgrade proceeds.
- CLI: To avoid command failure, include the following options in the command:

- `/remove_appdisk_ack`
- `/remove_pvd_ack`

Limitations

The following limitations apply to upgrades:

- **Selective component install:** If you install or upgrade any components to the new version but choose not to upgrade other components (on different machines) that require upgrade, Studio reminds you. For example, let's say an upgrade includes new versions of the Controller and Studio. You upgrade the Controller but you do not run the installer on the machine where Studio is installed. Studio will not let you continue to manage the site until you upgrade Studio.

You do not have to upgrade VDAs, but Citrix recommends upgrading all VDAs to enable you to use all available features.

- **Early Release or Technology Preview versions:** You cannot upgrade from an Early Release, Technology Preview, or preview version.
- **Components on earlier operating systems:** You cannot install current VDAs on operating systems that are no longer supported by Microsoft or Citrix. For more information, see Earlier operating systems.
- **Mixed environments/sites:** If you must continue to run earlier version sites and current version sites, see Mixed environment considerations.
- **Product selection:** When you upgrade from an earlier version, you do not choose or specify the product (Citrix Virtual Apps or Citrix Virtual Apps and Desktops) that was set during the installation.

Mixed environment considerations

When you upgrade, Citrix recommends that you upgrade all components and VDAs so that you can access all the new and enhanced features in your edition and version.

For example, although you can use current VDAs in deployments containing earlier Controller versions, new features in the current release might not be available. VDA registration issues can also occur when using non-current versions.

In some environments, you might not be able to upgrade all VDAs to the most current version. In that case, when you create a machine catalog, you can specify the VDA version installed on the machines. (This is called the functional level.) By default, this setting specifies the minimum recommended VDA version. The default value is sufficient for most deployments. Consider changing the setting to an

earlier version only if the catalog contains VDAs earlier than the default. Mixing VDA versions in a machine catalog is not recommended.

If a catalog is created with the default minimum VDA version setting, and one or more machines has a VDA earlier than the default version, those machines cannot register with the Controller, and will not work.

For more information, see [VDA versions and functional levels](#).

Multiple sites with different versions

When your environment contains sites with different product versions (for example, a XenDesktop 7.18 site and a Citrix Virtual Apps and Desktops 1909 site), Citrix recommends using StoreFront to aggregate applications and desktops from different product versions. For details, see the [StoreFront](#) documentation.

In a mixed environment, continue using the Studio and Director versions for each release, but ensure that different versions are installed on separate machines.

Earlier operating systems

Let's say you installed an earlier version of a component on a machine that was running a supported operating system (OS) version. Now, you want to use a newer component version, but that OS is no longer supported for the current version of the component.

For example, assume that you installed a server VDA on a Windows Server 2008 R2 machine. Now you want to upgrade that VDA to the current release, but Windows Server 2008 R2 is not supported in the current release you're upgrading to.

If you try to install or upgrade a component on an operating system that is no longer allowed, an error message displays, such as "Cannot be installed on this operating system".

These considerations apply to upgrading Current Release and Long Term Service Release versions. (It does not affect applying CUs to an LTSR version.)

Follow the links to learn which OSs are supported:

- Citrix Virtual Apps and Desktops (Current Release):
 - [Delivery Controller, Studio, Director, VDAs, Universal Print Server](#)
 - [Federated Authentication Service](#)
 - For [StoreFront](#), [Self-Service Password Reset](#), and [Session Recording](#), see the system requirements article for the current release.
- For LTSRs, see the components lists for your LTSR version and CU. (Select your LTSR version from the main [Citrix Virtual Apps and Desktops](#) product documentation page.)

Invalid operating systems

The following table lists the earlier operating systems that are not valid for installing/upgrading components in the current release. It indicates the latest valid component version supported for each listed OS, and the component version when installation and upgrade became invalid.

The operating systems in the table include service packs and updates.

| Operating system | Component/feature | Latest valid version | Install/upgrade not possible as of version |
|--|---------------------------------|----------------------|--|
| Windows 7 and
Windows 8 | VDA | 7.15 LTSR | 7.16 |
| Windows 7 and
Windows 8 | Other installer
components | 7.17 | 7.18 |
| Windows 10 versions
earlier than 1607 | VDA | 7.15 LTSR | 7.16 |
| Windows 10 x86
version | VDA | 1906.2.0 | 1909 |
| Windows Server 2008
R2 | VDA | 7.15 LTSR | 7.16 |
| Windows Server 2008
R2 | Other installer
components | 7.17 | 7.18 |
| Windows Server 2012 | VDA | 7.15 LTSR | 7.16 |
| Windows Server 2012 | Other installer
components | 7.17 | 7.18 |
| Windows Server 2012
R2 | Other installer
components * | 1912 LTSR | 2003 |
| Windows Server 2012
R2 | Server VDI | 7.15 LTSR | 7.16 |

Windows XP and Windows Vista are not valid for any 7.x components or technologies.

* Applies to Delivery Controller, Studio, Director, and VDAs.

What you can do

You have choices. You can:

- Continue with the current OS
- Reimage or upgrade the machine
- Add new machines and then remove old machines

Continue with the current OS These methods are feasible for VDAs. If you want to continue using machines with the earlier OS, you can choose one of the following:

- Continue using the installed component version.
- Download the latest valid component version and then upgrade the component to that version. (This assumes that the latest valid component version isn't already installed.)

For example, you have a 7.14 VDA on a Windows 7 SP1 machine. The latest valid VDA version on Windows 7 OS machines is XenApp and XenDesktop 7.15 LTSR. You can either continue using 7.14, or download a 7.15 LTSR VDA and then upgrade your VDA to that version. Those earlier VDA versions work in deployments containing Delivery Controllers with newer versions. For example, a 7.15 LTSR VDA can connect to a Citrix Virtual Apps and Desktops 7 1808 Controller.

Reimage or upgrade the machine These methods are feasible for VDAs and other machines that do not have core components (such as Delivery Controllers) installed. Choose one of the following:

- After taking the machine out of service (turning on maintenance mode and allowing all sessions to close), you can reimage it to a supported Windows OS version, and then install the latest version of the component.
- To upgrade the OS without reimaging, uninstall the Citrix software before upgrading the OS (this includes internal upgrades to your OS. For example, Windows 10 version 1903 to Windows 10 version 1909). Otherwise, the Citrix software will be unsupported. Then, install the new component.
- To upgrade the OS in a VDA machine without reimaging, you must first install the VDA version that is supported on the OS that you are upgrading to or upgrade the VDA after upgrading the OS. Otherwise, the Citrix software will be unsupported. You can upgrade to the following minimum OS versions when performing an in-place upgrade without uninstalling the VDA:
 - Windows 11 with [2023-07 Cumulative Update for Windows 11 \(KB5028185\)](#) or later installed (build 22621.1992 or later).
 - Windows 10 with [2023-07 Dynamic Update for Windows 10 \(KB5028311\)](#) installed.
- If the Windows version you plan to upgrade to does not align with the aforementioned guideline, you must uninstall the VDA before upgrading the OS, and then install a supported VDA version after the OS upgrade is complete.

Add new machines and then remove old machines This method is feasible if you must upgrade the OS on machines containing a Delivery Controller or other core component.

Citrix recommends that all Controllers in a site have the same OS. The following upgrade sequence minimizes the interval when different Controllers have different OSs.

1. Take a snapshot of all Delivery Controllers in the site and then back up the site database.

2. Install new Delivery Controllers on clean servers with supported operating systems. For example, install a Controller on two Windows Server 2016 machines.
3. Add the new Controllers to the site.
4. Remove the Controllers that are running on operating systems that are not valid for the current release. For example, remove two Controllers on two Windows Server 2008 R2 machines. Follow the recommendations for removing Controllers in [Delivery Controllers](#).

Preparation

Before beginning an upgrade, review the following information and complete necessary tasks.

Note:

Although upgrading VDAs occurs later in the upgrade sequence, it's a good idea to choose an installer and review the procedure before you start the upgrade, so you know what to expect.

Choose an installer and interface

Use the full-product installer from the product ISO to upgrade components. You can upgrade VDAs using the full-product installer or one of the standalone VDA installers. All installers offer graphical and command line interfaces.

For more information, see [Installers](#).

Installation specifics: After you complete any preparation work and are ready to start the installer, the installation article shows you what you will see (if you're using the graphical interface) or what to type (if you're using the command-line interface).

- [Install/upgrade core components using the graphical interface](#)
- [Install/upgrade core components using the command line](#)
- [Install/upgrade VDAs using the graphical interface](#)
- [Install/upgrade VDAs using the command line](#)

If you originally installed a single-session VDA with the `VDAWorkstationCoreSetup.exe` installer, Citrix recommends using that installer to upgrade it. If you use the full-product VDA installer or the `VDAWorkstationSetup.exe` installer to upgrade the VDA, the components that were originally excluded might be installed, unless you expressly omit/exclude them from the upgrade.

When upgrading a VDA to the current release, a machine restart occurs during the upgrade process. (This requirement started with the 7.17 release.) This cannot be avoided. The upgrade resumes automatically after the restart (unless you specify `/noresume` on the command line).

Database actions

Back up the site, monitoring, and configuration logging databases. Follow the instructions in [CTX135207](#). If any issues are discovered after the upgrade, you can restore the backup.

For information about upgrading SQL Server versions that are no longer supported, see [SQL Server version check](#). (This refers to the SQL Server that is used for the site, monitor, and configuration logging databases.)

Microsoft SQL Server Express LocalDB is installed automatically, for use with Local Host Cache. If you need to replace an earlier version, the new version must be SQL Server Express LocalDB 2019. For details about replacing SQL Server Express LocalDB with the new version after you upgrade the components and the site, see [Replace SQL Server Express LocalDB](#).

Ensure that your Citrix licensing is up-to-date

For a comprehensive look at managing Citrix Licensing, see [Activate, upgrade, and manage Citrix licenses](#).

You can use the full-product installer to upgrade the License Server. Or, you can download and upgrade the license components separately. See [Upgrade](#).

Before upgrading, be sure your Customer Success Services / Software Maintenance / Subscription Advantage date is valid for the new product version. The date must be at least 2021.11.15.

Ensure that your Citrix License Server is compatible

Ensure that your Citrix License Server is compatible with the new version. There are two ways to do this:

- Before upgrading any other Citrix components, run the [XenDesktopServerSetup.exe](#) installer from the ISO layout on the machine containing a Delivery Controller. If there are any incompatibility issues, the installer reports it with recommended steps to resolve the issues.
- From the [XenDesktop Setup](#) directory on the installation media, run the command: `.\LicServVerify.exe -h <license-server-fqdn> -p 27000 -v`. The display indicates whether the License Server is compatible. If the License Server is incompatible, upgrade the license server.

Back up any StoreFront modifications

Before starting an upgrade, if you have made modifications to files in `C:\inetpub\wwwroot\Citrix\<StoreName>\App_Data`, such as *default.ica* and *usernamepassword.tfrm*, back them

up for each store. After the upgrade you can restore them to reinstate your modifications.

Close applications and consoles

Before starting an upgrade, close all programs that might potentially cause file locks, including administration consoles and PowerShell sessions.

Restarting the machine ensures that any file locks are cleared, and that there are no Windows updates pending.

Before starting an upgrade, stop and disable any third-party monitoring agent services.

Ensure that you have proper permissions

In addition to being a domain user, you must be a local administrator on the machines where you are upgrading product components.

The site database and the site can be upgraded automatically or manually. For an automatic database upgrade, the Studio user's permissions must include the ability to update the SQL Server database schema (for example, the `db_securityadmin` or `db_owner` database role). For details, see [Data-bases](#).

If the Studio user does not have those permissions, initiating a manual database upgrade generates scripts. The Studio user runs some of the scripts from Studio. The database administrator runs other scripts, using a tool such as SQL Server Management Studio.

Other preparation tasks

- Back up templates and upgrade hypervisors, if needed
- Complete any other preparation tasks dictated by your business continuity plan.

Preliminary site tests

When you upgrade Delivery Controllers and a site, preliminary site tests run before the actual upgrade begins. These tests verify:

- The site database can be reached and has been backed up
- Connections to essential Citrix services are working correctly
- The Citrix License Server address is available
- The configuration logging database can be reached

- Ensure you have Hybrid Rights License if you want to add public cloud host connections (for example, AWS). Otherwise, the preliminary site test pauses or stops, and an explanatory message appears.

After the tests run, you can view a report of the results. You can then fix any issues that were detected, and run the tests again. Failure to run the preliminary site tests and then resolve any issues can impact how your site works.

The report containing the test results is an HTML file (`PreliminarySiteTestResult.html`) in the same directory as the installation logs. That file is created if it does not exist. If the file exists, its content is overwritten.

Run the tests

- When you're using the installer's graphical interface to upgrade, the wizard includes a page where you can start the tests and then display the report. After the tests run and you have viewed the report and resolved any issues that were found, you can rerun the tests. When the tests complete successfully, click Next to continue with the wizard.
- When you're using the command-line interface to upgrade, the tests run automatically. By default, if a test fails, the upgrade is not performed. After you view the report and resolve issues, rerun the command.

Citrix recommends always running the preliminary site tests and then resolving any issues before you continue the Controller and site upgrade. The potential benefit is well worth the few moments to run the tests. However, you can override this recommended action.

- When upgrading with the graphical interface, you can choose to skip the tests and continue with the upgrade.
- When upgrading from the command line, you cannot skip the tests. By default, a failed site test causes the installer to fail, without performing the upgrade. In most cases, if you include the `/ignore_site_test_failure` option, any test failures are ignored and the upgrade proceeds. (See SQL Server version check for exceptions.)

When upgrading multiple Controllers

When you start an upgrade on one Controller, and then start an upgrade of another Controller in the same site (before the first upgrade completes):

- If the preliminary site tests have completed on the first Controller, the preliminary site tests page does not appear in the wizard on the other Controller.

- If the tests on the first Controller are ongoing when you start the upgrade on the other Controller, the site tests page appears in the wizard on the other Controller. However, if the tests on the first Controller finish, only the test results from the first Controller are retained.

Test failures not related to the site's health

- If the preliminary site tests fail due to insufficient memory, make more memory available and then rerun the tests.
- If you have permission to upgrade, but not run site tests, the preliminary site tests fail. To resolve this, rerun the installer with a user account that has permission to run the tests.

SQL Server version check

A successful Citrix Virtual Apps and Desktops deployment requires a supported version of Microsoft SQL Server for the site, monitor, and configuration logging databases. Upgrading a Citrix deployment with a SQL Server version that's no longer supported can result in functionality issues, and the site will be unsupported.

To learn which SQL Server versions are supported for the Citrix release you're upgrading to, see the [System requirements](#) article for that release.

When upgrading a Controller, the Citrix installer checks the currently installed SQL Server version used for the site, monitor, and configuration logging databases.

- If the check determines that the currently installed SQL Server version is not a supported version in the Citrix release you're upgrading to:
 - Graphical interface: The upgrade halts with a message. Click **I understand** and then click **Cancel** to close the Citrix installer. (You cannot continue with the upgrade.)
 - Command-line interface: the command fails (even if you included the `/ignore_db_check_failure` option with the command).

Upgrade the SQL Server version, and then start the Citrix upgrade again.

- If the check cannot determine which SQL Server version is currently installed, see if your currently installed version is supported in the version you're upgrading to ([System requirements](#)).
 - Graphical interface: The upgrade halts with a message.
 - * If the currently installed SQL Server version is supported, click **I understand** to close the message, and then click **Next** to continue with the Citrix upgrade.
 - * If the currently installed SQL Server version is not supported, click **I understand** to close the message, and then click **Cancel** to end the Citrix upgrade. Upgrade your SQL Server to a supported version and then start the Citrix upgrade again.

- Command-line interface: The command fails with a message. After closing the message:
 - * If the currently installed SQL Server version is supported, run the command again with the `/ignore_db_check_failure` option.
 - * If the currently installed SQL Server version is not supported, upgrade your SQL Server to a supported version. Run the command again to start the Citrix upgrade.

Upgrading SQL Server

If you bring up new SQL Server servers and migrate the site database, then connection strings must be updated.

If the site currently uses SQL Server Express for the site database (that Citrix installed automatically during site creation):

1. Install the latest SQL Server Express version.
2. Detach the database.
3. Attach the database to the new SQL Server Express.
4. Migrate connection strings.

For more information, see [Configuring connection strings](#) and the Microsoft SQL Server product documentation.

Replace SQL Server Express LocalDB

Microsoft SQL Server Express LocalDB is a feature of SQL Server Express that Local Host Cache uses on a standalone basis. Local Host Cache does not require any components of SQL Server Express other than SQL Server Express LocalDB.

If you installed a Delivery Controller version earlier than 1912 and then upgrade your deployment to version 1912 or later, Citrix does not automatically upgrade the SQL Server Express LocalDB version. Why not? Because you might have non-Citrix components that rely on SQL Server Express LocalDB. If you have non-Citrix components that are using SQL Server Express LocalDB, ensure that upgrading SQL Server Express LocalDB does not disrupt those components. To upgrade (replace) the SQL Server Express LocalDB version, follow the guidance in this section.

- **When upgrading Delivery Controllers to Citrix Virtual Apps and Desktops version 1912 or 2003:** Upgrading SQL Server Express LocalDB is optional. Local Host Cache works properly, with no loss of functionality, regardless of whether you upgrade SQL Server Express LocalDB. We added the option to move to a newer version of SQL Server Express LocalDB in case there are concerns about end of support from Microsoft for SQL Server Express LocalDB 2014.

- **When upgrading Delivery Controllers to Citrix Virtual Apps and Desktops versions newer than 2003:** The supported version is SQL Server Express LocalDB 2019. If you originally installed a Delivery Controller earlier than version 1912, and have not replaced SQL Server Express LocalDB with the newer version since then, you must replace that database software now. Otherwise, Local Host Cache will not work.

What you need:

- The Citrix Virtual Apps and Desktops installation media (for the version you've upgraded to). The media contains a copy of Microsoft SQL Server Express LocalDB 2019.
- A Windows Sysinternals tool that you download from Microsoft.

Procedure:

1. Complete the upgrade of your Citrix Virtual Apps and Desktops components, databases, and site. (Those database upgrades affect the site, monitoring, and configuration logging databases. They do not affect the Local Host Cache database that uses SQL Server Express LocalDB.)
2. On the Delivery Controller, download [PsExec](#) from Microsoft. See the Microsoft document [PsExec v2.2](#).
3. Stop the Citrix High Availability Service.
4. From the command prompt, run [PsExec](#) and switch to the Network Service account.

```
psexec -i -u "NT AUTHORITY\NETWORKSERVICE"cmd
```

Optionally, you can use [whoami](#) to confirm that the command prompt is running as the Network Service account.

```
whoami
```

```
nt authority\networkservice
```

5. Move to the folder containing SqlLocalDB.

```
cd "C:\Program Files\Microsoft SQL Server\120\Tools\Binn"
```

6. Stop and delete CitrixHA (LocalDB).

```
SqlLocalDB stop CitrixHA
```

```
SqlLocalDB delete CitrixHA
```

7. Remove the related files in `C:\Windows\ServiceProfiles\NetworkService`.

```
1 HADatabaseName.*
2 HADatabaseName_log.*
3 HAImportDatabaseName.*
4 HAImportDatabaseName_log.*
5 <!--NeedCopy-->
```

Tip: Your deployment might not have `HAImportDatabaseName.*` and `HAImportDatabaseName_log.*`.

8. Uninstall SQL Server Express LocalDB 2014 from the server, using the Windows feature for removing programs.
9. Install SQL Server Express LocalDB 2019. In the `Support > SQLLocalDB` folder on the Citrix Virtual Apps and Desktops installation media, double-click `sqllocaldb.msi`. A restart might be requested to complete the installation. (The new SQLLocalDB resides in `C:\Program Files\Microsoft SQL Server\150\Tools\Binn.`)
10. Start the Citrix High Availability Service.
11. Ensure that the Local Host Cache database was created on each Delivery Controller. This confirms that the High Availability Service (secondary broker) can take over, if needed.
 - On the Controller server, browse to `C:\Windows\ServiceProfiles\NetworkService`.
 - Verify that `HaDatabaseName.mdf` and `HaDatabaseName_log.ldf` are created.

Secure

June 24, 2020

Citrix Virtual Apps and Desktops offers a secure-by-design solution that allows you to tailor your environment to your security needs.

One security concern IT faces with mobile workers is lost or stolen data. By hosting applications and desktops, Citrix Virtual Apps and Desktops securely separates sensitive data and intellectual property from end-point devices by keeping all data in a data center. When policies are enabled to allow data transfer, all data is encrypted.

The Citrix Virtual Apps and Desktops data centers also make incident response easier with a centralized monitoring and management service. Director allows IT to monitor and analyze data that is being accessed around the network, and Studio allows IT to patch and remedy most vulnerabilities in the data center instead of fixing the problems locally on each end-user device.

Citrix Virtual Apps and Desktops also simplify audits and regulatory compliance because investigators can use a centralized audit trail to determine who accessed what applications and data. Director gathers historical data regarding updates to the system and user data usage by accessing Configuration Logging and OData API.

Delegated administration allows you to set up administrator roles to control access to Citrix Virtual Apps and Desktops at a granular level. This allows flexibility in your organization to give certain ad-

administrators full access to tasks, operations, and scopes while other administrators have limited access.

Citrix Virtual Apps and Desktops give administrators granular control over users by applying policies at different levels of the network - from the local level to the Organizational Unit level. This control of policies determines if a user, device, or groups of users and devices can connect, print, copy/paste, or map local drives, which can minimize security concerns with third-party contingency workers. Administrators can also use the Desktop Lock feature so end users can only use the virtual desktop while preventing any access to the local operating system of the end-user device.

Administrators can increase security on Citrix Virtual Apps or Citrix Virtual Desktops by configuring the Site to use the Transport Layer Security (TLS) protocol of the Controller or between end users and Virtual Delivery Agents (VDA). The protocol can also be enabled on a Site to provide server authentication, data stream encryption, and message integrity checks for a TCP/IP connection.

Citrix Virtual Apps and Desktops also support multifactor authentication for Windows or a specific application. Multifactor authentication can also be used to manage all resources delivered by Citrix Virtual Apps and Desktops. These methods include:

- Tokens
- Smart cards
- RADIUS
- Kerberos
- Biometrics

Citrix Virtual Desktops can be integrated with many third-party security solutions, ranging from identity management to antivirus software. A list of supported products can be found at <http://www.citrix.com/ready>.

Select releases of Citrix Virtual Apps and Desktops are certified for Common Criteria standard. For a list of those standards, go to <https://www.commoncriteriaportal.org/cc/>.

FIDO2 and WebAuthn authentication

October 9, 2023

Local authorization and virtual authentication using FIDO2 and WebAuthn

Users can authenticate to applications that leverage FIDO2 or WebAuthn in their virtual session using FIDO2 security keys and integrated biometrics devices with TPM 2.0 and Windows Hello.

For more information about FIDO2, see [FIDO2: WebAuthn & CTAP](#).

For information about using this feature, see [FIDO2 redirection](#).

NOTE

Please note that this feature does not support logging into the virtual session using WebAuthn or FIDO2. This feature only allows using these authentication methods in applications within the virtual session.

This feature is not supported in double-hop scenarios.

Supportability matrix

| Session host operating system | Web application authentication | UWP application authentication |
|-------------------------------|--------------------------------|--------------------------------|
| Windows Server 2016 | Supported via USB redirection | Not supported |
| Windows Server 2019 | Supported | Not supported |
| Windows Server 2022 | Supported | Supported |
| Windows 10 | Supported | Supported |
| Windows 11 | Supported | Supported |

For additional information, please review the requirements below.

Web application authentication**Requirements**

The following are the requirements for using FIDO2 and WebAuthn authentication with web applications:

Citrix control plane

- Citrix Virtual Apps and Desktops 2009 or later

Session host

- Operating system
 - Windows 10 1809 or later
 - Windows Server 2019 or later

- VDA
 - Windows: version 2009 or later

Client device

- Operating system
 - Windows 10 1809 or later
 - Linux: Please refer to the Workspace app for Linux [system requirements](#)
- Workspace app
 - Windows: version 2009.1 or later
 - Linux: 2303 or later

Web browser requirements

- 64-bit browsers only

Authentication methods supported

- FIDO2 Security Key
- Windows Hello
 - TPM 2.0
 - Integrated biometrics
 - * Facial recognition
 - * Fingerprint scanner
 - WebAuthn

UWP application authentication

With the release of Citrix Virtual Apps and Desktops 2112, Citrix supports WebAuthn and FIDO2 authentication in UWP applications.

Applications such as Microsoft Teams, Microsoft Outlook for Office 365 and OneDrive use a UWP application for authentication as a link to Azure Active Directory. Citrix now supports using FIDO2 to authenticate those applications.

Requirements

The following are the requirements for using FIDO2 and WebAuthn authentication with UWP applications:

Citrix control plane

- Citrix Virtual Apps and Desktops 2112 or later

Session host

- Operating system
 - Windows 10 1809 or later
 - Windows Server 2022 or later
- VDA
 - Windows: version 2112 or later

Client device

- Operating system
 - Windows 10 1809 or later
 - Linux: Please refer to the Workspace app for Linux [system requirements](#)
- Workspace app
 - Windows: version 2009.1 or later
 - Linux: 2303 or later

Authentication methods supported

- FIDO2 Security Key
- Windows Hello
 - TPM 2.0
 - Integrated biometrics
 - * Facial recognition
 - * Fingerprint scanner
 - WebAuthn

Note:

In scenarios where FIDO2 redirection is not available because the feature is not supported by the client or VDA or the operating system, USB based FIDO2 keys can be redirected using USB redirection.

It is also possible to use USB redirection to redirect USB based FIDO2 keys in scenarios where FIDO2 redirection is available. In this case, you must disable FIDO2 redirection and configure the appropriate USB redirection rules.

Please refer to the [USB redirection device rules](#) documentation for details on how to configure USB redirection rules.

Integrate Citrix Virtual Apps and Desktops with Citrix Gateway

December 18, 2019

StoreFront servers are deployed and configured to manage access to published resources and data. For remote access, adding Citrix Gateway in front of StoreFront is recommended.

Note:

For detailed configuration steps on how to integrate Citrix Virtual Apps and Desktops with Citrix Gateway, see the [StoreFront documentation](#).

The following diagram illustrates an example of a simplified Citrix deployment that includes Citrix Gateway. Citrix Gateway communicates with StoreFront to protect apps and data delivered by Citrix Virtual Apps and Desktops. The user devices run Citrix Workspace app to create a secure connection and access their apps, desktops, and files.

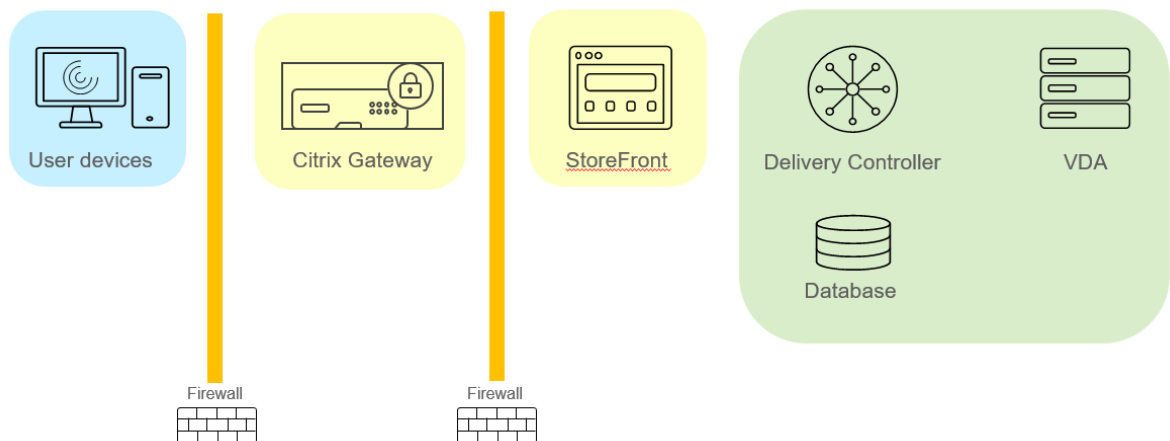

Users log on and authenticate using Citrix Gateway. Citrix Gateway is deployed and secured in the DMZ. Two-factor authentication is configured. Based on the user credentials, users are provided with the relevant resources and applications. Applications and data are on appropriate servers (not shown on the diagram). Separate servers used for security sensitive applications and data.

Security considerations and best practices

January 6, 2023

Note:

Your organization may need to meet specific security standards to satisfy regulatory requirements. This document does not cover this subject, because such security standards change over time. For up-to-date information on security standards and Citrix products, consult <http://www.citrix.com/security/>.

Security best practices

Keep all machines in your environment up to date with security patches. One advantage is that you can use thin clients as terminals, which simplifies this task.

Protect all machines in your environment with antivirus software.

Consider using platform-specific anti-malware software.

When installing software, install to provided default paths.

- If you install software to a file location other than the provided default path, consider adding additional security measures, such as restricted permissions, to your file location.

All network communications should be appropriately secured and encrypted to match your security policy. You can secure all communication between Microsoft Windows computers using IPSec; refer to your operating system documentation for details about how to do this. In addition, communication between user devices and desktops is secured through Citrix SecureICA, which is configured by default to 128-bit encryption. You can configure SecureICA when you are creating or updating a Delivery Group.

Note:

Citrix SecureICA forms part of the ICA/HDX protocol but it is not a standards-compliant network security protocol like Transport Layer Security (TLS). You can also secure network communications between user devices and desktops using TLS. To configure TLS, see [Transport Layer Security \(TLS\)](#).

Apply Windows best practice for account management. Do not create an account on a template or image before it is duplicated by Machine Creation Services or Provisioning Services. Do not schedule tasks using stored privileged domain accounts. Do not manually create shared Active Directory machine accounts. These practices will help prevent a machine attack from obtaining local persistent account passwords and then using them to log on to MCS/PVS shared images belonging to others.

Firewalls

Protect all machines in your environment with perimeter firewalls, including at enclave boundaries as appropriate.

All machines in your environment should be protected by a personal firewall. When you install core components and VDAs, you can choose to have the ports required for component and feature communication opened automatically if the Windows Firewall Service is detected (even if the firewall is not enabled). You can also choose to manually configure those firewall ports. If you use a different firewall, you must manually configure it.

If you are migrating a conventional environment to this release, you may need to reposition an existing perimeter firewall or add new perimeter firewalls. For example, suppose there is a perimeter firewall between a conventional client and database server in the data center. When this release is used, that perimeter firewall must be placed so that the virtual desktop and user device are on one side, and the database servers and Delivery Controllers in the data center are on the other side. Therefore, consider creating an enclave within your data center to contain the database servers and Controllers. Also consider having protection between the user device and the virtual desktop.

Note:

TCP ports 1494 and 2598 are used for ICA and CGP and are therefore likely to be open at firewalls so that users outside the data center can access them. Citrix recommends that you do not use these ports for anything else, to avoid the possibility of inadvertently leaving administrative interfaces open to attack. Ports 1494 and 2598 are officially registered with the Internet Assigned Number Authority (<http://www.iana.org/>).

Application security

To prevent non-admin users from performing malicious actions, we recommend that you configure Windows AppLocker rules for installers, applications, executables and scripts on the VDA host and on the local Windows client.

Manage user privileges

Grant users only the capabilities they require. Microsoft Windows privileges continue to be applied to desktops in the usual way: configure privileges through User Rights Assignment and group memberships through Group Policy. One advantage of this release is that it is possible to grant a user administrative rights to a desktop without also granting physical control over the computer on which the desktop is stored.

Note the following when planning for desktop privileges:

- By default, when non-privileged users connect to a desktop, they see the time zone of the system running the desktop instead of the time zone of their own user device. For information on how to allow users to see their local time when using desktops, see the [Manage Delivery Groups](#) article.
- A user who is an administrator on a desktop has full control over that desktop. If a desktop is a pooled desktop rather than a dedicated desktop, the user must be trusted in respect of all other users of that desktop, including future users. All users of the desktop need to be aware of the potential permanent risk to their data security posed by this situation. This consideration does not apply to dedicated desktops, which have only a single user; that user should not be an administrator on any other desktop.
- A user who is an administrator on a desktop can generally install software on that desktop, including potentially malicious software. The user can also potentially monitor or control traffic on any network connected to the desktop.

Manage logon rights

Logon rights are required for both user accounts and computer accounts. As with Microsoft Windows privileges, logon rights continue to be applied to desktops in the usual way: configure logon rights through User Rights Assignment and group memberships through Group Policy.

The Windows logon rights are: log on locally, log on through Remote Desktop Services, log on over the network (access this computer from the network), log on as a batch job, and log on as a service.

For computer accounts, grant computers only the logon rights they require. The logon right “Access this computer from the network” is required:

- At VDAs, for the computer accounts of Delivery Controllers
- At Delivery Controllers, for the computer accounts of VDAs. See [Active Directory OU-based Controller discovery](#).
- At StoreFront servers, for the computer accounts of other servers in the same StoreFront server group

For user accounts, grant users only the logon rights they require.

According to Microsoft, by default the group Remote Desktop Users is granted the logon right “Allow log on through Remote Desktop Services” (except on domain controllers).

Your organization’s security policy may state explicitly that this group should be removed from that logon right. Consider the following approach:

- The Virtual Delivery Agent (VDA) for Multi-session OS uses Microsoft Remote Desktop Services. You can configure the Remote Desktop Users group as a restricted group, and control membership of the group via Active Directory group policies. Refer to Microsoft documentation for more information.

- For other components of Citrix Virtual Apps and Desktops, including the VDA for Single-session OS, the group Remote Desktop Users is not required. So, for those components, the group Remote Desktop Users does not require the logon right “Allow log on through Remote Desktop Services”; you can remove it. Additionally:
 - If you administer those computers via Remote Desktop Services, ensure that all such administrators are already members of the Administrators group.
 - If you do not administer those computers via Remote Desktop Services, consider disabling Remote Desktop Services itself on those computers.

Although it is possible to add users and groups to the login right “Deny logon through Remote Desktop Services”, the use of deny logon rights is not generally recommended. Refer to Microsoft documentation for more information.

Configure user rights

Delivery Controller installation creates the following Windows services:

- Citrix AD Identity Service (NT SERVICE\CitrixADIdentityService): Manages Microsoft Active Directory computer accounts for VMs.
- Citrix Analytics (NT SERVICE\CitrixAnalytics): Collects site configuration usage information for use by Citrix, if this collection been approved by the site administrator. It then submits this information to Citrix, to help improve the product.
- Citrix App Library (NT SERVICE\CitrixAppLibrary): Supports management and provisioning of AppDisks, AppDNA integration, and management of App-V.
- Citrix Broker Service (NT SERVICE\CitrixBrokerService): Selects the virtual desktops or applications that are available to users.
- Citrix Configuration Logging Service (NT SERVICE\CitrixConfigurationLogging): Records all configuration changes and other state changes made by administrators to the site.
- Citrix Configuration Service (NT SERVICE\CitrixConfigurationService): Site-wide repository for shared configuration.
- Citrix Delegated Administration Service (NT SERVICE\CitrixDelegatedAdmin): Manages the permissions granted to administrators.
- Citrix Environment Test Service (NT SERVICE\CitrixEnvTest): Manages self-tests of the other Delivery Controller services.
- Citrix Host Service (NT SERVICE\CitrixHostService): Stores information about the hypervisor infrastructures used in a Citrix Virtual Apps or Citrix Virtual Desktops deployment, and also offers functionality used by the console to enumerate resources in a hypervisor pool.
- Citrix Machine Creation Services (NT SERVICE\CitrixMachineCreationService): Orchestrates the creation of desktop VMs.

- Citrix Monitor Service (NT SERVICE\CitrixMonitor): Collects metrics for Citrix Virtual Apps or Citrix Virtual Desktops, stores historical information, and provides a query interface for troubleshooting and reporting tools.
- Citrix Storefront Service (NT SERVICE\CitrixStorefront): Supports management of StoreFront. (It is not part of the StoreFront component itself.)
- Citrix Storefront Privileged Administration Service (NT SERVICE\CitrixPrivilegedService): Supports privileged management operations of StoreFront. (It is not part of the StoreFront component itself.)
- Citrix Config Synchronizer Service (NT SERVICE\CitrixConfigSyncService): Propagates configuration data from the main site database to the Local Host Cache.
- Citrix High Availability Service (NT SERVICE\CitrixHighAvailabilityService): Selects the virtual desktops or applications that are available to users, when the main site database is unavailable.

Delivery Controller installation also creates the following Windows services. These are also created when installed with other Citrix components:

- Citrix Diagnostic Facility COM Server (NT SERVICE\CdfSvc): Supports the collection of diagnostic information for use by Citrix Support.
- Citrix Telemetry Service (NT SERVICE\CitrixTelemetryService): Collects diagnostic information for analysis by Citrix, such that the analysis results and recommendations can be viewed by administrators to help diagnose issues with the site.

Delivery Controller installation also creates the following Windows service. This is not currently used. If it has been enabled, disable it.

- Citrix Remote Broker Provider (NT SERVICE\XaXdCloudProxy)

Delivery Controller installation also creates these following Windows services. These are not currently used, but must be enabled. Do not disable them.

- Citrix Orchestration Service (NT SERVICE\CitrixOrchestration)
- Citrix Trust Service (NT SERVICE\CitrixTrust)

Except for the Citrix Storefront Privileged Administration Service, these services are granted the logon right Log on as a service and the privileges Adjust memory quotas for a process, Generate security audits, and Replace a process level token. You do not need to change these user rights. These privileges are not used by the Delivery Controller and are automatically disabled.

Configure service settings

Except for the Citrix Storefront Privileged Administration service and the Citrix Telemetry Service, the Delivery Controller Windows services listed above in the Configure user rights section are configured to log on as the NETWORK SERVICE identity. Do not alter these service settings.

The Citrix Config Synchronizer Service needs the NETWORK SERVICE account to belong to the Local Administrator group on the Delivery Controller. This allows Local Host Cache to work correctly.

The Citrix Storefront Privileged Administration service is configured to log on Local System (NT AUTHORITY\SYSTEM). This is required for Delivery Controller StoreFront operations that are not normally available to services (including creating Microsoft IIS sites). Do not alter its service settings.

The Citrix Telemetry Service is configured to log on as its own service-specific identity.

You can disable the Citrix Telemetry Service. Apart from this service, and services that are already disabled, do not disable any other of these Delivery Controller Windows services.

Configure registry settings

It is no longer necessary to enable creation of 8.3 file names and folders on the VDA file system. The registry key **NtfsDisable8dot3NameCreation** can be configured to disable creation of 8.3 file names and folders. You can also configure this using the **fsutil.exe behavior set disable8dot3** command.

Deployment scenario security implications

Your user environment can contain either user devices that are unmanaged by your organization and completely under the control of the user, or user devices that are managed and administered by your organization. The security considerations for these two environments are generally different.

Managed user devices

Managed user devices are under administrative control; they are either under your own control, or the control of another organization that you trust. You may configure and supply user devices directly to users; alternatively, you may provide terminals on which a single desktop runs in full-screen-only mode. Follow the general security best practices described above for all managed user devices. This release has the advantage that minimal software is required on a user device.

A managed user device can be configured to be used in full-screen-only mode or in window mode:

- Full-screen-only mode: Users log on to it with the usual Log On To Windows screen. The same user credentials are then used to log on automatically to this release.
- Users see their desktop in a window: Users first log on to the user device, then log on to this release through a web site supplied with the release.

Unmanaged user devices

User devices that are not managed and administered by a trusted organization cannot be assumed to be under administrative control. For example, you might permit users to obtain and configure their own devices, but users might not follow the general security best practices described above. This release has the advantage that it is possible to deliver desktops securely to unmanaged user devices. These devices should still have basic antivirus protection that will defeat keylogger and similar input attacks.

Data storage considerations

When using this release, you can prevent users from storing data on user devices that are under their physical control. However, you must still consider the implications of users storing data on desktops. It is not good practice for users to store data on desktops; data should be held on file servers, database servers, or other repositories where it can be appropriately protected.

Your desktop environment may consist of various types of desktops, such as pooled and dedicated desktops. Users should never store data on desktops that are shared amongst users, such as pooled desktops. If users store data on dedicated desktops, that data should be removed if the desktop is later made available to other users.

Mixed-version environments

Mixed-version environments are inevitable during some upgrades. Follow best-practice and minimize the time that Citrix components of different versions co-exist. In mixed-version environments, security policy, for example, may not be uniformly enforced.

Note:

This is typical of other software products; the use of an earlier version of Active Directory only partially enforces Group Policy with later versions of Windows.

The following scenario describes a security issue that can occur in a specific mixed-version Citrix environment. When Citrix Receiver 1.7 is used to connect to a virtual desktop running the VDA in XenApp and XenDesktop 7.6 Feature Pack 2, the policy setting **Allow file transfer between desktop and client** is enabled in the Site but cannot be disabled by a Delivery Controller running XenApp and XenDesktop 7.1. It does not recognize the policy setting, which was released in the later version of the product. This policy setting allows users to upload and download files to their virtual desktop, which is the security issue. To work around this, upgrade the Delivery Controller (or a standalone instance of Studio) to version 7.6 Feature Pack 2 and then use Group Policy to disable the policy setting. Alternatively, use local policy on all affected virtual desktops.

Remote PC Access security considerations

Remote PC Access implements the following security features:

- Smart card use is supported.
- When a remote session connects, the office PC's monitor appears as blank.
- Remote PC Access redirects all keyboard and mouse input to the remote session, except CTRL+ALT+DEL and USB-enabled smart cards and biometric devices.
- SmoothRoaming is supported for a single user only.
- When a user has a remote session connected to an office PC, only that user can resume local access of the office PC. To resume local access, the user presses Ctrl-Alt-Del on the local PC and then logs on with the same credentials used by the remote session. The user can also resume local access by inserting a smart card or leveraging biometrics, if your system has appropriate third-party Credential Provider integration. This default behavior can be overridden by enabling Fast User Switching via Group Policy Objects (GPOs) or by editing the registry.

Note:

Citrix recommends that you do not assign VDA administrator privileges to general session users.

Automatic assignments

By default, Remote PC Access supports automatic assignment of multiple users to a VDA. In XenDesktop 5.6 Feature Pack 1, administrators could override this behavior using the RemotePCAccess.ps1 PowerShell script. This release uses a registry entry to allow or prohibit multiple automatic remote PC assignments; this setting applies to the entire Site.

Caution:

Editing the registry incorrectly can cause serious problems that may require you to reinstall your operating system. Citrix cannot guarantee that problems resulting from the incorrect use of Registry Editor can be solved. Use Registry Editor at your own risk. Be sure to back up the registry before you edit it.

To restrict automatic assignments to a single user:

On each Controller in the Site, set the following registry entry:

```
1 HKEY\LOCAL_MACHINE\Software\Citrix\DesktopServer
2 Name: AllowMultipleRemotePCAssignments
3 Type: REG_DWORD
4 Data: 0 = Disable multiple user assignment, 1 = (Default) Enable
   multiple user assignment.
```

If there are any existing user assignments, remove them using SDK commands for the VDA to subsequently be eligible for a single automatic assignment.

- Remove all assigned users from the VDA: `$machine.AssociatedUserNames | % { Remove-BrokerUser-Name $_ -Machine $machine }`
- Remove the VDA from the Delivery Group: `$machine | Remove-BrokerMachine - DesktopGroup $desktopGroup`

Restart the physical office PC.

XML trust

The XML trust setting applies to deployments that use:

- An on-premises StoreFront.
- A subscriber (user) authentication technology that does not require passwords. Examples of such technologies are domain pass-through, smart cards, SAML, and Veridium solutions.

Enabling the XML trust setting allows users to successfully authenticate and then start applications. The Delivery Controller trusts the credentials sent from StoreFront. Enable this setting only when you have secured communications between your Delivery Controllers and StoreFront (using firewalls, IPsec, or other security recommendations).

This setting is disabled by default.

Use the Citrix Virtual Apps and Desktops PowerShell SDK to check, enable, or disable the XML trust setting.

- To check the XML trust setting's current value, run `Get-BrokerSite` and inspect the value of `TrustRequestsSentToTheXMLServicePort`.
- To enable XML trust, run `Set-BrokerSite -TrustRequestsSentToTheXmlServicePort $true`.
- To disable XML trust, run `Set-BrokerSite -TrustRequestsSentToTheXmlServicePort $false`.

Smart cards

February 8, 2022

Smart cards and equivalent technologies are supported within the guidelines described in this article. To use smart cards with Citrix Virtual Apps or Citrix Virtual Desktops:

- Understand your organization's security policy concerning the use of smart cards. These policies might, for example, state how smart cards are issued and how users must safeguard them. Some aspects of these policies might need to be reassessed in a Citrix Virtual Apps or Citrix Virtual Desktops environment.
- Determine which user device types, operating systems, and published applications are to be used with smart cards.
- Familiarize yourself with smart card technology and your selected smart card vendor hardware and software.
- Know how to deploy digital certificates in a distributed environment.

Note:

Smart card enrollment is not supported with [fast smart card](#). Smart card enrollment might work when fast smart card is disabled, but depends on the type of smart card and middleware. Contact your smart card and middleware vendor for information on their integration with Citrix Virtual Apps and Desktops and support for smart card enrollment over virtual sessions.

Types of smart cards

Enterprise and consumer smart cards have the same dimensions, electrical connectors, and fit the same smart card readers.

Smart cards for enterprise use contain digital certificates. These smart cards support Windows Logon, and can also be used with applications for digital signing and encryption of documents and email. Citrix Virtual Apps and Desktops support these uses.

Smart cards for consumer use do not contain digital certificates; they contain a shared secret. These smart cards can support payments (such as a chip-and-signature or chip-and-PIN credit card). They do not support Windows Logon or typical Windows applications. Specialized Windows applications and a suitable software infrastructure (including, for example, a connection to a payment card network) are needed for use with these smart cards. Contact your Citrix representative for information on supporting these specialized applications on Citrix Virtual Apps or Citrix Virtual Desktops.

For enterprise smart cards, there are compatible equivalents that can be used in a similar way.

- A smart card-equivalent USB token connects directly to a USB port. These USB tokens are usually the size of a USB flash drive, but can be as small as a SIM card used in a mobile phone. They appear as the combination of a smart card plus a USB smart card reader.
- A virtual smart card using a Windows Trusted Platform Module (TPM) appears as a smart card. These virtual smart cards are supported for Windows 8 and Windows 10, using Citrix Workspace app (minimum version Citrix Receiver 4.3).

- Versions of Citrix Virtual Apps and Desktops (formerly XenApp and XenDesktop) earlier than XenApp and XenDesktop 7.6 FP3 do not support virtual smart cards.
- For more information on virtual smart cards, see [Virtual Smart Card Overview](#).

Note: The term “virtual smart card” is also used to describe a digital certificate stored on the user computer. These digital certificates are not strictly equivalent to smart cards.

Citrix Virtual Apps and Desktops smart card support is based on the Microsoft Personal Computer/Smart Card (PC/SC) standard specifications. A minimum requirement is that smart cards and smart card devices must be supported by the underlying Windows operating system and must be approved by the Microsoft Windows Hardware Quality Labs (WHQL) to be used on computers running qualifying Windows operating systems. See the Microsoft documentation for additional information about hardware PC/SC compliance. Other types of user devices might comply with the PS/SC standard. For more information, refer to the [Citrix Ready program](#).

Usually, a separate device driver is needed for each vendor’s smart card or equivalent. However, if smart cards conform to a standard such as the NIST Personal Identity Verification (PIV) standard, it might be possible to use a single device driver for a range of smart cards. The device driver must be installed on both the user device and the Virtual Delivery Agent (VDA). The device driver is often supplied as part of a smart card middleware package available from a Citrix partner; the smart card middleware package offers advanced features. The device driver might also be described as a Cryptographic Service Provider (CSP), Key Storage Provider (KSP), or minidriver.

The following smart card and middleware combinations for Windows systems have been tested by Citrix as representative examples of their type. However, other smart cards and middleware can also be used. For more information about Citrix-compatible smart cards and middleware, see <http://www.citrix.com/ready>.

| Middleware | Matching cards |
|-----------------------------------|------------------|
| Gemalto Mini Driver for .NET card | Gemalto .NET v2+ |

For information about smart card usage with other types of devices, see the Citrix Workspace app documentation for that device.

Remote PC Access

Smart cards are supported only for remote access to physical office PCs running Windows 10, Windows 8 or Windows 7.

The following smart cards were tested with Remote PC Access:

| | |
|-------------------------|------------------|
| Middleware | Matching cards |
| Gemalto .NET minidriver | Gemalto .NET v2+ |

Fast smart card

Fast smart card is an improvement over the existing HDX PC/SC-based smart card redirection. It improves performance when smart cards are used in high-latency WAN situations. When latency is high, the performance improvement can be significant (for example, 15 seconds for a Windows fast smart card logon versus more than 1 minute with the PC/SC-based smart card redirection).

Fast smart card is enabled by default on host machines with currently supported Windows VDAs. To disable Fast Smart Card on the host-side—for example for diagnostic purposes—set the ‘Disable Cryptographic Redirection’ registry setting to any non-zero value:

```
1 HKLM\SOFTWARE\Citrix\SmartCard
2 CryptographicRedirectionDisable (DWORD)
3 <!--NeedCopy-->
```

On the client side, to enable fast smart card, include the SmartCardCryptographicRedirection ICA parameter in the *default.ica* file of the associated StoreFront site:

```
1 [WFClient]
2 SmartCardCryptographicRedirection=0n
```

In addition, on the client side, fast smart card can be force enabled or force disabled (for example, for diagnostic purposes) with the following registry settings:

- HKLM\SOFTWARE[\WOW6432Node]\Citrix\ICA Client\SmartCard\ForceEnableCryptographicRedirection (as a non-zero DWORD)

Or

- HKLM\SOFTWARE[\WOW6432Node]\Citrix\ICA Client\SmartCard\ForceDisableCryptographicRedirection (as a non-zero DWORD)

The 32-bit registry hive must be specified (using [WOW6432Node](#)) if the client machine is 64-bit.

Limitations:

- Only Citrix Workspace app for Windows supports fast smart card. If you configure fast smart cards in the *default.ica* file, Citrix Workspace apps that are not for Windows still use existing PC/SC Redirection.
- The only double-hop scenarios that fast smart card supports are ICA > ICA with fast smart card enabled on both hops. Because fast smart card doesn't support ICA > RDP double-hop scenarios, those scenarios don't work.

- Fast smart card doesn't support Cryptography Next Generation. Thus, fast smart card doesn't support Elliptic Curve Cryptography (ECC) smart cards.
- Fast smart card supports only read-only key container operations.
- Fast smart card doesn't support changing the smart card PIN.

Starting with VDA version 2203 and Citrix Workspace app version 2202 for Windows (or later) fast smart card is compatible with Cryptography Next Generation (CNG). In addition, Elliptic Curve Cryptography (ECC) smart cards are supported with the following curves: P-256, P-384, P-521 bits, for both ECDSA and ECDH.

Starting with VDA version 2203, fast smart card adds the ability to cache the smart card PIN between the applications from the same user's logon session. For example, if **Session PIN Caching** is enabled and the end user has previously provided their smart card PIN to Outlook, when Word is then used to sign a document, Word uses the already cached smart card PIN (submitted to Outlook). **Session PIN Caching** helps the user experience by reducing the number of times the user has to enter their smart card PIN. In addition, if the smart card is used to log on to the VDA, the Windows smart card logon PIN can optionally be saved to the **Session PIN Cache**. This can further improve the user experience.

Session PIN Caching is disabled by default. It can be enabled and controlled with the following registry settings on the VDA:

In HKLM\SOFTWARE\Citrix\SmartCard:

- `EnablePinSessionCache` as a DWORD (non-zero to enable)
- `EnableLogonPinSessionCache` as a DWORD (non-zero to enable)
- `PinSessionCacheEntryStaleTimeout` as a DWORD (number of seconds before an entry becomes stale, default is 1 hour)

Types of smart card readers

A smart card reader might be built in to the user device, or be separately attached to the user device (usually via USB or Bluetooth). Contact card readers that comply with the USB Chip/Smart Card Interface Devices (CCID) specification are supported. They contain a slot or swipe into which the user inserts the smart card. The Deutsche Kreditwirtschaft (DK) standard defines four classes of contact card readers.

- Class 1 smart card readers are the most common, and usually contain a slot. Class 1 smart card readers are supported, usually with a standard CCID device driver supplied with the operating system.
- Class 2 smart card readers also contain a secure keypad that cannot be accessed by the user device. Class 2 smart card readers might be built into a keyboard with an integrated secure keypad. For class 2 smart card readers, contact your Citrix representative; a reader-specific device driver might be required to enable the secure keypad capability.

- Class 3 smart card readers also contain a secure display. Class 3 smart card readers are not supported.
- Class 4 smart card readers also contain a secure transaction module. Class 4 smart card readers are not supported.

Note:

The smart card reader class is unrelated to the USB device class.

Smart card readers must be installed with a corresponding device driver on the user device.

For information about supported smart card readers, see the documentation for the Citrix Workspace app you are using. In the Citrix Workspace app documentation, supported versions are listed in a smart card article or in the system requirements article.

User experience

Smart card support is integrated into Citrix Virtual Apps and Desktops, using a specific ICA/HDX smart card virtual channel that is enabled by default.

Important: Do not use generic USB redirection for smart card readers. This is disabled by default for smart card readers, and is not supported if enabled.

Multiple smart cards and multiple readers can be used on the same user device, but if pass-through authentication is in use, only one smart card must be inserted when the user starts a virtual desktop or application. When a smart card is used within an application (for example, for digital signing or encryption functions), there might be other prompts to insert a smart card or enter a PIN. This can occur if more than one smart card has been inserted at the same time.

- If users are prompted to insert a smart card when the smart card is already in the reader, they must select Cancel.
- If users are prompted for the PIN, they must enter the PIN again.

You can reset PINs using a card management system or vendor utility.

Important:

Within a Citrix Virtual Apps or Citrix Virtual Desktops session, using a smart card with the Microsoft Remote Desktop Connection application is not supported. This is sometimes described as a “double hop” use.

Before deploying smart cards

- Obtain a device driver for the smart card reader and install it on the user device. Many smart card readers can use the CCID device driver supplied by Microsoft.

- Obtain a device driver and cryptographic service provider (CSP) software from your smart card vendor, and install them on both user devices and virtual desktops. The driver and CSP software must be compatible with Citrix Virtual Apps and Desktops; check the vendor documentation for compatibility. For virtual desktops using smart cards that support and use the minidriver model, smart card minidrivers download automatically, but you can also obtain them from <http://catalog.update.microsoft.com> or from your vendor. Also, if PKCS#11 middleware is required, obtain it from the card vendor.
- Important: Citrix recommends that you install and test the drivers and CSP software on a physical computer before installing Citrix software.
- Add the Citrix Receiver for Web URL to the Trusted Sites list for users who use smart cards in Internet Explorer with Windows 10. In Windows 10, Internet Explorer does not run in protected mode by default for trusted sites.
- Ensure that your public key infrastructure (PKI) is configured appropriately. This includes ensuring that certificate-to-account mapping is correctly configured for Active Directory environment and that user certificate validation can be performed successfully.
- Ensure that your deployment meets the system requirements of the other Citrix components used with smart cards, including Citrix Workspace app and StoreFront.
- Ensure access to the following servers in your Site:
 - The Active Directory domain controller for the user account that is associated with a logon certificate on the smart card
 - Delivery Controller
 - Citrix StoreFront
 - Citrix Gateway/Citrix Access Gateway 10.x
 - VDA
 - (Optional for Remote PC Access): Microsoft Exchange Server

Enable smart card use

Step 1. Issue smart cards to users according to your card issuance policy.

Step 2. (Optional) Set up the smart cards to enable users for Remote PC Access.

Step 3. Install and configure the Delivery Controller and StoreFront (if not already installed) for smart card remoting.

Step 4. Enable StoreFront for smart card use. For details, see Configure smart card authentication in the StoreFront documentation.

Step 5. Enable Citrix Gateway/Access Gateway for smart card use. For details, see Configuring Authentication and Authorization and Configuring Smart Card Access with the Web Interface in the NetScaler documentation.

Step 6. Enable VDAs for smart card use.

- Ensure that the VDA has the required applications and updates.
- Install the middleware.
- Set up smart card remoting, enabling the communication of smart card data between Citrix Workspace app on a user device and a virtual desktop session.

Step 7. Enable user devices (including domain-joined or non-domain-joined machines) for smart card use. See [Configure smart card authentication](#) in the StoreFront documentation for details.

- Import the certificate authority root certificate and the issuing certificate authority certificate into the device's keystore.
- Install your vendor's smart card middleware.
- Install and configure Citrix Workspace app for Windows, being sure to import icaclient.adm using the Group Policy Management Console and enable smart card authentication.

Step 8. Test the deployment. Ensure that the deployment is configured correctly by launching a virtual desktop with a test user's smart card. Test all possible access mechanisms (for example, accessing the desktop through Internet Explorer and Citrix Workspace app).

Track smart card reader insertion count

With smart card remoting, you can track the number of times a smart card has been inserted or removed from a reader using the `SCardGetStatusChange` function. The function updates an array of `SCARD_READERSTATE` data structures—one per each reader you monitor. The high word (16 bits) of the `dwEventState` field of each `SCARD_READERSTATE` contains the reader count. For more information, see the Microsoft articles [SCardGetStatusChangeA function](#) and [SCARD_READERSTATEA structure](#).

The **Reader Insert Count Reporting** setting is disabled by default. To enable tracking, add the following registry key:

HKEY_LOCAL_MACHINE\SOFTWARE\Citrix\SmartCard

Name: EnableReaderInsertCountReporting

Type: DWORD

Value: Any non-zero value

When the session disconnects, the count resets to zero.

Reader Insert Count Reporting is compatible with third-party smart card middleware.

Smart card deployments

October 30, 2020

The following types of smart card deployments are supported by this product version and by mixed environments containing this version. Other configurations might work but are not supported.

| Type | StoreFront connectivity |
|---|---|
| Local domain-joined computers | Directly connected |
| Remote access from domain-joined computers | Connected through Citrix Gateway |
| Non-domain-joined computers | Directly connected |
| Remote access from non-domain-joined computers | Connected through Citrix Gateway |
| Non-domain-joined computers and thin clients accessing the Desktop Appliance site | Connected through Desktop Appliance sites |
| Domain-joined computers and thin clients accessing StoreFront through the XenApp Services URL | Connected through XenApp Services URLs |

The deployment types are defined by the characteristics of the user device to which the smart card reader is connected:

- Whether the device is domain-joined or non-domain-joined.
- How the device is connected to StoreFront.
- What software is used to view virtual desktops and applications.

In addition, smart card-enabled applications such as Microsoft Word, and Microsoft Excel can be used in these deployments. Those applications allow users to digitally sign or encrypt documents.

Bimodal authentication

Where possible in each of these deployments, Receiver supports bimodal authentication by offering the user a choice between using a smart card and entering their user name and password. This is useful if the smart card cannot be used (for example, the user has left it at home or the logon certificate has expired).

Because users of non-domain-joined devices log on to Receiver for Windows directly, you can enable users to fall back to explicit authentication. If you configure bimodal authentication, users are initially

prompted to log on using their smart cards and PINs but have the option to select explicit authentication if they experience any issues with their smart cards.

If you deploy Citrix Gateway, users log on to their devices and are prompted by Receiver for Windows to authenticate to Citrix Gateway. This applies to both domain-joined and non-domain-joined devices. Users can log on to Citrix Gateway using either their smart cards and PINs, or with explicit credentials. This enables you to provide users with bimodal authentication for Citrix Gateway logons. Configure pass-through authentication from Citrix Gateway to StoreFront and delegate credential validation to Citrix Gateway for smart card users so that users are silently authenticated to StoreFront.

Multiple Active Directory forest considerations

In a Citrix environment, smart cards are supported within a single forest. Smart card logons across forests require a direct two-way forest trust to all user accounts. More complex multi-forest deployments involving smart cards (that is, where trusts are only one-way or of different types) are not supported.

You can use smart cards in a Citrix environment that includes remote desktops. This feature can be installed locally (on the user device that the smart card is connected to) or remotely (on the remote desktop that the user device connects to).

Smart card removal policy

The smart card removal policy set on the product determines what happens if you remove the smart card from the reader during a session. The smart card removal policy is configured through and handled by the Windows operating system.

| Policy setting | Desktop behavior |
|--|---|
| No action | No action. |
| Lock workstation | The desktop session is disconnected and the virtual desktop is locked. |
| Force logoff | The user is forced to log off. If the network connection is lost and this setting is enabled, the session may be logged off and the user may lose data. |
| Disconnect if a remote Terminal Services session | The session is disconnected and the virtual desktop is locked. |

Certificate revocation checking

If certificate revocation checking is enabled and a user inserts a smart card with an invalid certificate into a card reader, the user cannot authenticate or access the desktop or application related to the certificate. For example, if the invalid certificate is used for email decryption, the email remains encrypted. If other certificates on the card, such as ones used for authentication, are still valid, those functions remain active.

Deployment example: domain-joined computers

This deployment involves domain-joined user devices that run the Desktop Viewer and connect directly to StoreFront.

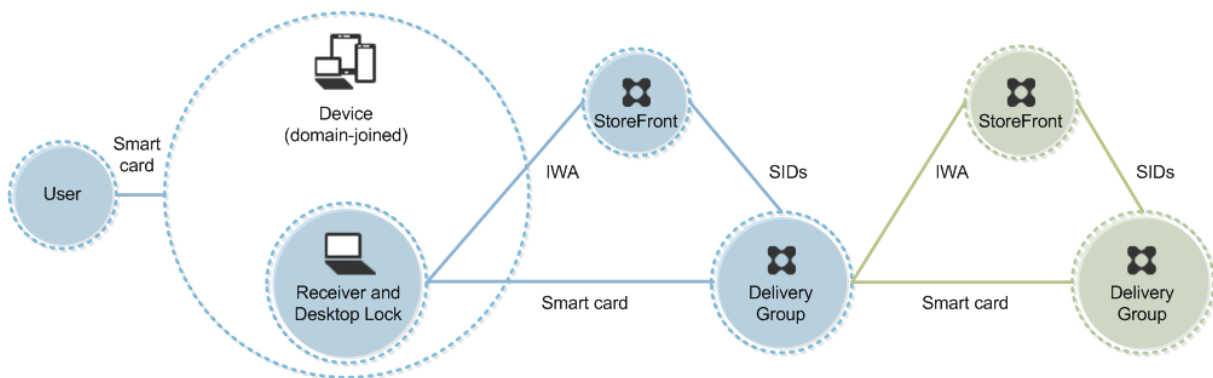

A user logs on to a device using a smart card and PIN. Receiver authenticates the user to a Storefront server using Integrated Windows Authentication (IWA). StoreFront passes the user security identifiers (SIDs) to Citrix Virtual Apps or Citrix Virtual Desktops. When the user starts a virtual desktop or application, the user is not prompted for a PIN again because the single sign-on feature is configured on Receiver.

This deployment can be extended to a double-hop with the addition of a second StoreFront server and a server hosting applications. A Receiver from the virtual desktop authenticates to the second StoreFront server. Any authentication method can be used for this second connection. The configuration shown for the first hop can be reused in the second hop or used in the second hop only.

Deployment example: remote access from domain-joined computers

This deployment involves domain-joined user devices that run the Desktop Viewer and connect to StoreFront through Citrix Gateway/Access Gateway.

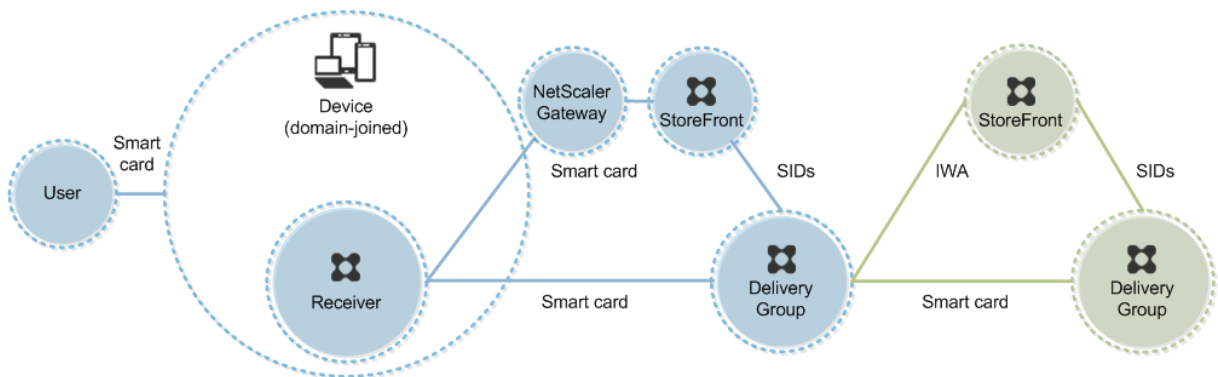

A user logs on to a device using a smart card and PIN, and then logs on again to Citrix Gateway/Access Gateway. This second logon can be with either the smart card and PIN or a user name and password because Receiver allows bimodal authentication in this deployment.

The user is automatically logged on to StoreFront, which passes the user security identifiers (SIDs) to Citrix Virtual Apps or Citrix Virtual Desktops. When the user starts a virtual desktop or application, the user is not prompted again for a PIN because the single sign-on feature is configured on Receiver.

This deployment can be extended to a double-hop with the addition of a second StoreFront server and a server hosting applications. A Receiver from the virtual desktop authenticates to the second StoreFront server. Any authentication method can be used for this second connection. The configuration shown for the first hop can be reused in the second hop or used in the second hop only.

Deployment example: non-domain-joined computers

This deployment involves non-domain-joined user devices that run the Desktop Viewer and connect directly to StoreFront.

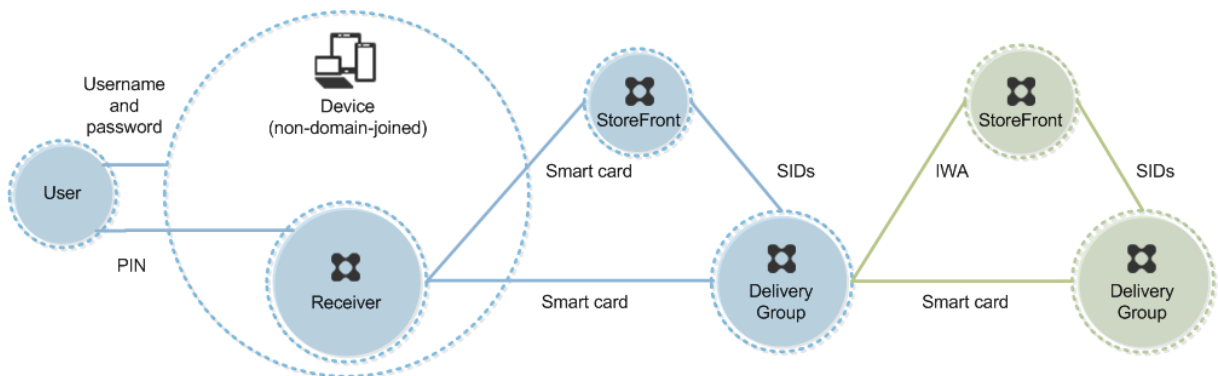

A user logs on to a device. Typically, the user enters a user name and password but, since the device is not joined to a domain, credentials for this logon are optional. Because bimodal authentication is possible in this deployment, Receiver prompts the user either for a smart card and PIN or a user name and password. Receiver then authenticates to Storefront.

StoreFront passes the user security identifiers (SIDs) to Citrix Virtual Apps or Citrix Virtual Desktops. When the user starts a virtual desktop or application, the user is prompted for a PIN again because the single sign-on feature is not available in this deployment.

This deployment can be extended to a double-hop with the addition of a second StoreFront server and a server hosting applications. A Receiver from the virtual desktop authenticates to the second StoreFront server. Any authentication method can be used for this second connection. The configuration shown for the first hop can be reused in the second hop or used in the second hop only.

Deployment example: remote access from non-domain-joined computers

This deployment involves non-domain-joined user devices that run the Desktop Viewer and connect directly to StoreFront.

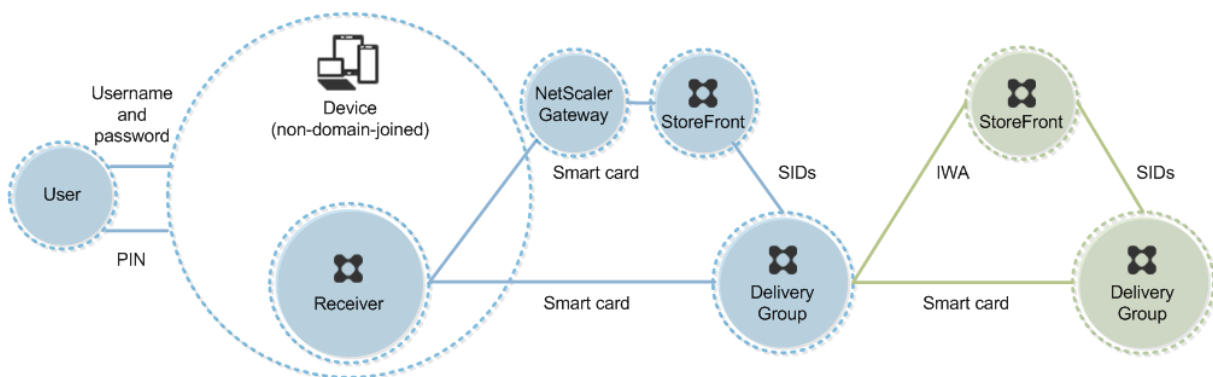

A user logs on to a device. Typically, the user enters a user name and password but, since the device is not joined to a domain, credentials for this logon are optional. Because bimodal authentication is possible in this deployment, Receiver prompts the user either for a smart card and PIN or a user name and password. Receiver then authenticates to Storefront.

StoreFront passes the user security identifiers (SIDs) to Citrix Virtual Apps or Citrix Virtual Desktops. When the user starts a virtual desktop or application, the user is prompted for a PIN again because the single sign-on feature is not available in this deployment.

This deployment can be extended to a double-hop with the addition of a second StoreFront server and a server hosting applications. A Receiver from the virtual desktop authenticates to the second StoreFront server. Any authentication method can be used for this second connection. The configuration shown for the first hop can be reused in the second hop or used in the second hop only.

Deployment example: non-domain-joined computers and thin clients accessing the Desktop Appliance site

This deployment involves non-domain-joined user devices that may run the Desktop Lock and connect to StoreFront through Desktop Appliance sites.

The Desktop Lock is a separate component that is released with Citrix Virtual Apps, Citrix Virtual Desktops, and VDI-in-a-Box. It is an alternative to the Desktop Viewer and is designed mainly for repurposed Windows computers and Windows thin clients. The Desktop Lock replaces the Windows shell and Task Manager in these user devices, preventing users from accessing the underlying devices. With the Desktop Lock, users can access Windows Server Machine desktops and Windows Desktop Machine desktops. Installation of Desktop Lock is optional.

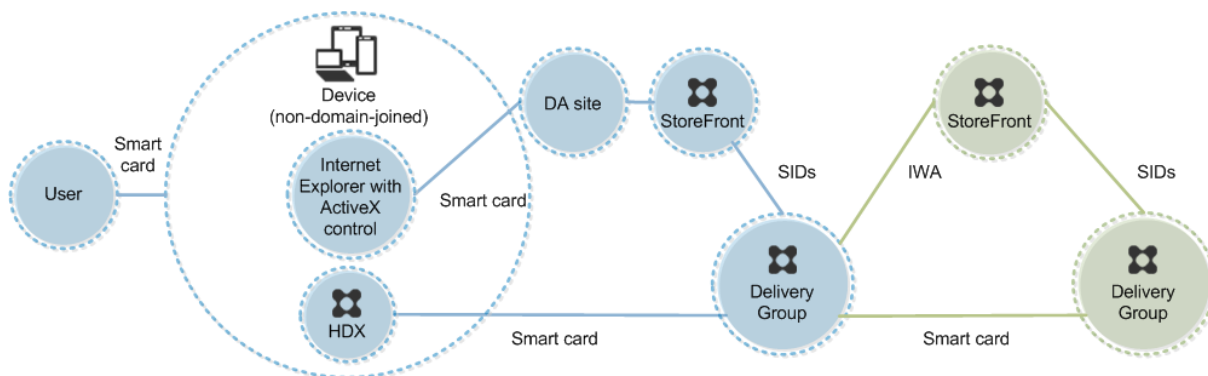

A user logs on to a device with a smart card. If Desktop Lock is running on the device, the device is configured to launch a Desktop Appliance site through Internet Explorer running in Kiosk Mode. An ActiveX control on the site prompts the user for a PIN, and sends it to StoreFront. StoreFront passes the user security identifiers (SIDs) to Citrix Virtual Apps or Citrix Virtual Desktops. The first available desktop in the alphabetical list in an assigned Desktop Group starts.

This deployment can be extended to a double-hop with the addition of a second StoreFront server and a server hosting applications. A Receiver from the virtual desktop authenticates to the second StoreFront server. Any authentication method can be used for this second connection. The configuration shown for the first hop can be reused in the second hop or used in the second hop only.

Deployment example: domain-joined computers and thin clients accessing StoreFront through the XenApp Services URL

This deployment involves domain-joined user devices that run the Desktop Lock and connect to StoreFront through XenApp Services URLs.

The Desktop Lock is a separate component that is released with Citrix Virtual Apps, Citrix Virtual Desktops, and VDI-in-a-Box. It is an alternative to the Desktop Viewer and is designed mainly for repurposed Windows computers and Windows thin clients. The Desktop Lock replaces the Windows shell and Task Manager in these user devices, preventing users from accessing the underlying devices. With the Desktop Lock, users can access Windows Server Machine desktops and Windows Desktop Machine desktops. Installation of Desktop Lock is optional.

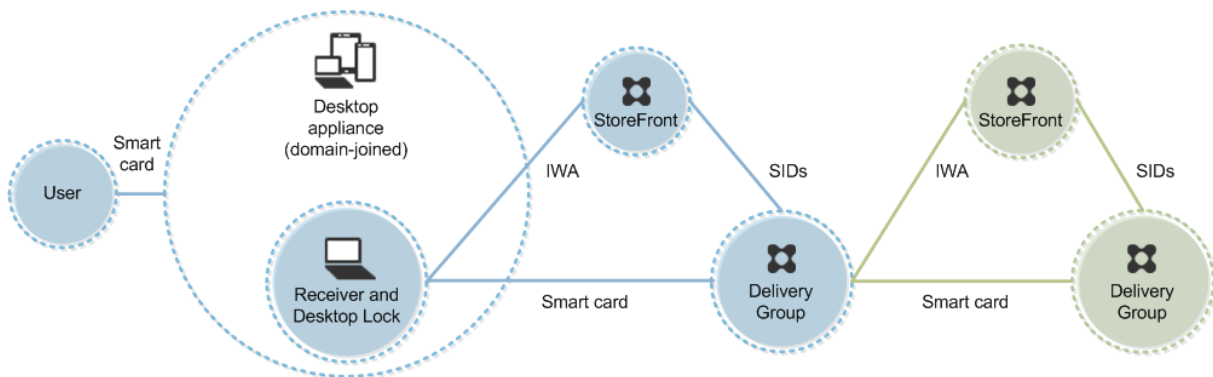

A user logs on to a device using a smart card and PIN. If Desktop Lock is running on the device, it authenticates the user to a Storefront server using Integrated Windows Authentication (IWA). StoreFront passes the user security identifiers (SIDs) to Citrix Virtual Apps or Citrix Virtual Desktops. When the user starts a virtual desktop, the user is not prompted for a PIN again because the single sign-on feature is configured on Receiver.

This deployment can be extended to a double-hop with the addition of a second StoreFront server and a server hosting applications. A Receiver from the virtual desktop authenticates to the second StoreFront server. Any authentication method can be used for this second connection. The configuration shown for the first hop can be reused in the second hop or used in the second hop only.

Pass-through authentication and single sign-on with smart cards

June 3, 2020

Pass-through authentication

Pass-through authentication with smart cards to virtual desktops is supported on user devices running Windows 10, Windows 8, and Windows 7 SP1 Enterprise and Professional Editions.

Pass-through authentication with smart cards to hosted applications is supported on servers running Windows Server 2016, Windows Server 2012 R2, Windows Server 2012, and Windows Server 2008 R2 SP1.

To use pass-through authentication with smart cards hosted applications, ensure you enable the use of Kerberos when you configure Pass-through with smartcard as the authentication method for the site.

Note: The availability of pass-through authentication with smart cards depends on many factors including, but not limited to:

- Your organization's security policies regarding pass-through authentication.
- Middleware type and configuration.
- Smart card reader types.
- Middleware PIN caching policy.

Pass-through authentication with smart cards is configured on Citrix StoreFront. See the StoreFront documentation for details.

Single sign-on

Single sign-on is a Citrix feature that implements pass-through authentication with virtual desktop and application launches. You can use this feature in domain-joined, direct-to-StoreFront and domain-joined, NetScaler-to-StoreFront smart card deployments to reduce the number of times that users enter their PIN. To use single sign-on in these deployment types, edit the following parameters in the default.ica file, which is located on the StoreFront server:

- Domain-joined, direct-to-StoreFront smart card deployments —Set DisableCtrlAltDel to Off
- Domain-joined, NetScaler-to-StoreFront smart card deployments —Set UseLocalUserAndPassword to On

For more instructions on setting these parameters, see the StoreFront or Citrix Gateway documentation.

The availability of single sign-on functionality depends on many factors including, but not limited to:

- Your organization's security policies regarding single sign-on.
- Middleware type and configuration.
- Smart card reader types.
- Middleware PIN caching policy.

Note:

When a user logs on to the Virtual Delivery Agent (VDA) on a machine with an attached smart card reader, a Windows tile may appear representing the previous successful mode of authentication, such as smart card or password. As a result, when single sign-on is enabled, the single sign-on tile may appear. To log on, the user must select **Switch Users** to select another tile because the single sign-on tile will not work.

Transport Layer Security (TLS)

February 22, 2023

Citrix Virtual Apps and Desktops support the Transport Layer Security (TLS) protocol for TCP-based connections between components. Citrix Virtual Apps and Desktops also support the Datagram Transport Layer Security (DTLS) protocol for UDP-based ICA/HDX connections, using [adaptive transport](#).

TLS and DTLS are similar, and support the same digital certificates. Configuring a Citrix Virtual Apps or Citrix Virtual Desktops Site to use TLS also configures it to use DTLS. Use the following procedures; the steps are common to both TLS and DTLS except where noted:

- Obtain, install, and register a server certificate on all Delivery Controllers, and configure a port with the TLS certificate. For details, see [Install TLS server certificates on Controllers](#).

Optionally, you can change the ports the Controller uses to listen for HTTP and HTTPS traffic.

- Enable TLS connections between Citrix Workspace app and Virtual Delivery Agents (VDAs) by completing the following tasks:
 - Configure TLS on the machines where the VDAs are installed. (For convenience, further references to machines where VDAs are installed are simply called “VDAs.”) For general information, see [TLS settings on VDAs](#). It is highly recommended that you use the Citrix supplied PowerShell script to configure TLS/DTLS. For details, see [Configure TLS on a VDA using the PowerShell script](#). However, if you want to configure TLS/DTLS manually, see [Manually configure TLS on a VDA](#).
 - Configure TLS in the Delivery Groups containing the VDAs by running a set of PowerShell cmdlets in Studio. For details, see [Configure TLS on Delivery Groups](#).

Requirements and considerations:

- * Enabling TLS connections between users and VDAs is valid only for XenApp 7.6 and XenDesktop 7.6 Sites, plus later supported releases.
- * Configure TLS in the Delivery Groups and on the VDAs after you install components, create a Site, create machine catalogs, and create Delivery Groups.
- * To configure TLS in the Delivery Groups, you must have permission to change Controller access rules. A Full Administrator has this permission.
- * To configure TLS on the VDAs, you must be a Windows administrator on the machine where the VDA is installed.
- * On pooled VDAs that are provisioned by Machine Creation Services or Provisioning Services, the VDA machine image is reset on restart, causing previous TLS settings to be lost. Run the PowerShell script each time the VDA is restarted to reconfigure the TLS settings.

Warning:

For tasks that include working in the Windows registry—editing the registry incorrectly can cause serious problems that may require you to reinstall your operating system. Citrix cannot guarantee that problems resulting from the incorrect use of Registry Editor can be solved. Use Registry Editor at your own risk. Be sure to back up the registry before you edit it.

For information about enabling TLS to the Site database, see [CTX137556](#).

Install TLS server certificates on Controllers

For HTTPS, the XML Service supports TLS features by using server certificates, not client certificates. This section describes acquiring and installing TLS certificates in Delivery Controllers. The same steps can be applied to Cloud Connectors to encrypt STA and XML traffic.

Although there are various different types of certificate authorities and methods of requesting certificate from them, this article describes the Microsoft Certificate Authority. The Microsoft Certificate Authority needs to have a certificate template published with a purpose of Server Authentication.

If the Microsoft Certificate Authority is integrated into an Active Directory domain or into the trusted forest the Delivery Controllers are joined to, you can acquire a certificate from the Certificates MMC snap-in Certificate Enrollment wizard.

Requesting and installing a certificate

1. On the Delivery Controller, open the MMC console and add the Certificates snap-in. When prompted select Computer account.
2. Expand **Personal > Certificates**, then use the **All Tasks > Request New Certificate** context menu command.

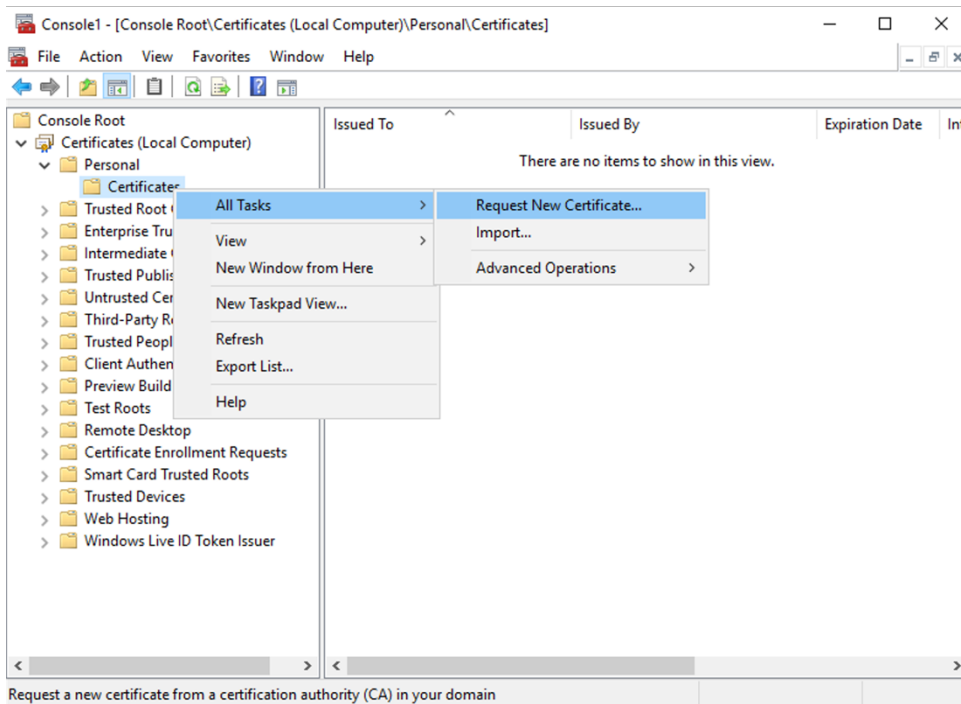

3. Click **Next** to begin, and **Next** to confirm that you are acquiring the certificate from Active Directory enrollment.
4. Select the template for Server Authentication certificate. If the template has been set up to automatically provide the values for Subject you can click **Enroll** without providing more details.

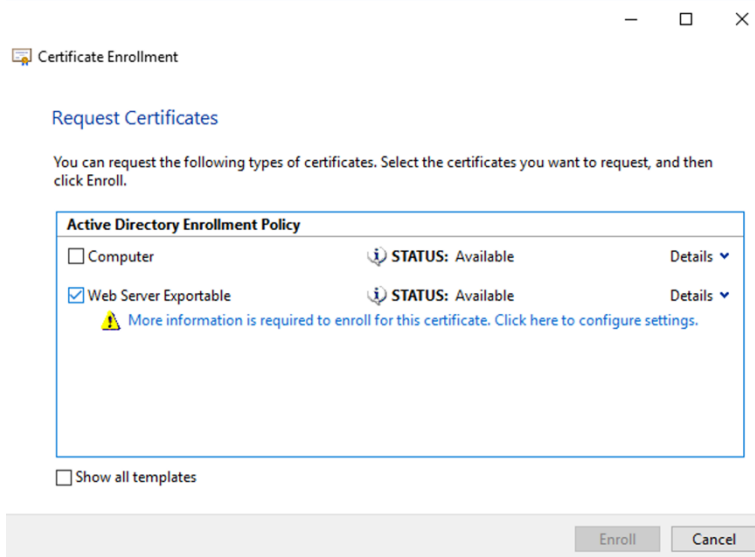

5. To provide more details for the certificate template, click the **Details** arrow button and configure the following:

Subject name: select Common Name and add the FQDN of the Delivery Controller.

Alternative name: select DNS and add the FQDN of the Delivery Controller.

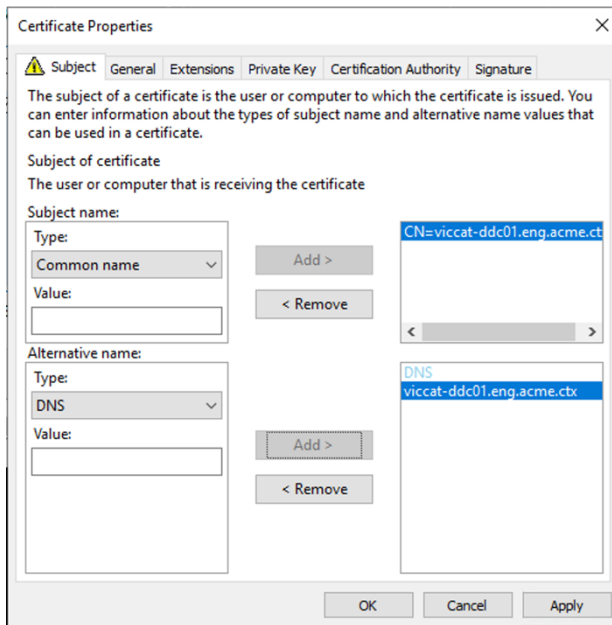

Configuring SSL/TLS listener port

1. Open a PowerShell command window as an administrator of the machine.
2. Run the following commands to get Broker Service Application GUID:

```

1 New-PSDrive -Name HKCR -PSProvider Registry -Root
   HKEY_CLASSES_ROOT
2
3 $Service_Guid = Get-ChildItem HKCR:\Installer\Products -Recurse -
   Ea 0 | Where-Object {
4   $key = $_; $_.GetValueNames() | ForEach-Object {
5   $key.GetValue($_) }
6   | Where-Object {
7   $_ -like 'Citrix Broker Service' }
8   }
9   | Select-Object Name
10
11 $Service_Guid.Name -match "[A-Z0-9]*$"
12
13 $Guid = $Matches[0]
14
15 [GUID]$Formatted_Guid = $Guid
16
17 Remove-PSDrive -Name HKCR
18
19 Write-Host "Broker Service Application GUID: $($Formatted_Guid)" -
   ForegroundColor Yellow
20 <!--NeedCopy-->

```

3. Run the following commands on the same PowerShell window to get the Thumbprint of the

certificate you installed previously:

```

1 $HostName = ([System.Net.Dns]::GetHostByName(($env:computerName)).
   .Hostname
2
3 $Thumbprint = (Get-ChildItem -Path Cert:\LocalMachine\My | Where-
   Object {
4   $_.Subject -match ("CN=" + $HostName) }
5   ).Thumbprint -join ';'
6
7 Write-Host -Object "Certificate Thumbprint for $($HostName): $(
   $Thumbprint)" -ForegroundColor Yellow
8 <!--NeedCopy-->

```

4. Run the following commands on the same PowerShell window to configure the Broker Service SSL/TLS port and use the certificate for encryption:

```

1 $IPV4_Address = Test-Connection -ComputerName $HostName -Count 1
   | Select-Object -ExpandProperty IPV4Address
2
3 $IPPort = "$($IPV4_Address):443"
4
5 $SSLxml = "http add sslcert ipport=$IPPort certhash=$Thumbprint
   appid={
6   $Formatted_Guid }
7   "
8
9 $SSLxml | netsh
10
11 . netsh http show sslcert
12 <!--NeedCopy-->

```

When correctly configured, the output from the last command `.netsh http show sslcert` shows that the listener is using the correct `IP:port`, and that `Application ID` matches the Broker Service Application GUID.

Providing the servers trust the certificate installed on the Delivery Controllers, you can now configure StoreFront Delivery Controllers and Citrix Gateway STA bindings to use HTTPS instead of HTTP.

Note:

If the Controller is installed on Windows Server 2016, and StoreFront is installed on Windows Server 2012 R2, a configuration change is needed at the Controller, to change the order of TLS cipher suites. This configuration change is not needed for Controller and StoreFront with other combinations of Windows Server versions.

The cipher suite order list must include the `TLS_ECDHE_RSA_WITH_AES_256_CBC_SHA384`, or `TLS_ECDHE_RSA_WITH_AES_128_CBC_SHA256` cipher suites (or both); and these cipher suites must precede any `TLS_DHE_` cipher suites.

1. Using the Microsoft Group Policy Editor, browse to **Computer Configuration > Administrative Templates > Network > SSL Configuration Settings**.
2. Edit the policy “SSL Cipher Suite Order”. By default, this policy is set to “Not Configured”. Set this policy to Enabled.
3. Arrange suites in the correct order; remove any cipher suites suites you do not want to use.

Ensure that either `TLS_ECDHE_RSA_WITH_AES_256_CBC_SHA384`, or `TLS_ECDHE_RSA_WITH_AES_128_GCM_SHA256`, precedes any `TLS_DHE_` cipher suites.

On Microsoft MSDN, see also [Prioritizing Schannel Cipher Suites](#).

Change HTTP or HTTPS ports

By default, the XML Service on the Controller listens on port 80 for HTTP traffic and port 443 for HTTPS traffic. Although you can use non-default ports, be aware of the security risks of exposing a Controller to untrusted networks. Deploying a standalone StoreFront server is preferable to changing the defaults.

To change the default HTTP or HTTPS ports used by the Controller, run the following command from Studio:

```
BrokerService.exe -WIPORT \<http-port> -WISSLPART \<https-port>
```

where `<http-port>` is the port number for HTTP traffic and `<https-port>` is the port number for HTTPS traffic.

Note:

After changing a port, Studio might display a message about license compatibility and upgrading. To resolve the issue, re-register service instances using the following PowerShell cmdlet sequence:

```
1 Get-ConfigRegisteredServiceInstance -ServiceType Broker -Binding  
   XML_HTTPS |  
2 Unregister-ConfigRegisteredServiceInstance  
3 Get-BrokerServiceInstance | where Binding -eq "XML_HTTPS" |  
4 Register-ConfigServiceInstance  
5 <!--NeedCopy-->
```

Enforce HTTPS traffic only

If you want the XML Service to ignore HTTP traffic, create the following registry setting in `HKLM\Software\Citrix\DesktopServer\` on the Controller and then restart the Broker Service.

To ignore HTTP traffic, create `DWORD XmlServicesEnableNonSsl` and set it to 0.

There is a corresponding registry DWORD value you can create to ignore HTTPS traffic: DWORD XmlServicesEnableSsl. Ensure that it is not set to 0.

TLS settings on VDAs

A Delivery Group cannot have a mixture of some VDAs with TLS configured and some VDAs without TLS configured. Before you configure TLS for a Delivery Group, ensure that you have already configured TLS for all the VDAs in that Delivery Group

When you configure TLS on VDAs, permissions on the installed TLS certificate are changed, giving the ICA Service read access to the certificate's private key, and informing the ICA Service of the following:

- **Which certificate in the certificate store to use for TLS.**
- **Which TCP port number to use for TLS connections.**

The Windows Firewall (if enabled) must be configured to allow incoming connection on this TCP port. This configuration is done for you when you use the PowerShell script.

- **Which versions of the TLS protocol to allow.**

Important:

Citrix recommends that you review your use of SSLv3, and reconfigure those deployments to remove support for SSLv3 where appropriate. See [CTX200238](#).

The supported TLS protocol versions follow a hierarchy (lowest to highest): SSL 3.0, TLS 1.0, TLS 1.1, TLS 1.2, and TLS 1.3. Specify the minimum allowed version; all protocol connections using that version or a higher version are allowed.

For example, if you specify TLS 1.1 as the minimum version, then TLS 1.1 and TLS 1.3 protocol connections are allowed. If you specify SSL 3.0 as the minimum version, then connections for all the supported versions are allowed. If you specify TLS 1.3 as the minimum version, only TLS 1.3 connections are allowed.

DTLS 1.0 corresponds to TLS 1.1, and DTLS 1.3 corresponds to TLS 1.3.

- **Which TLS cipher suites to allow.**

A cipher suite selects the encryption that is used for a connection. Clients and VDAs can support different sets of cipher suites. When a client (Citrix Workspace app or StoreFront) connects and sends a list of supported TLS cipher suites, the VDA matches one of the client's cipher suites with one of the cipher suites in its own list of configured cipher suites, and accepts the connection. If there is no matching cipher suite, the VDA rejects the connection.

The VDA supports three sets of cipher suites (also known as compliance modes): GOV(ernment), COM(mercial), and ALL. The acceptable cipher suites also depend on the Windows FIPS mode; see <http://support.microsoft.com/kb/811833> for information about Windows FIPS mode. The following table lists the cipher suites in each set:

| TLS/DTLS | | | | | | |
|--|------------|------------|------------|------------|------------|------------|
| cipher suite | ALL | COM | GOV | ALL | COM | GOV |
| FIPS Mode | Off | Off | Off | On | On | On |
| TLS_ECDHE_RSA_WITH_AES_256_GCM_SHA384* | | | | X | | X |
| TLS_ECDHE_RSA_WITH_AES_256_CBC_SHA384 | | | | X | | X |
| TLS_ECDHE_RSA_WITH_AES_128_CBC_SHA | | | | X | X | |

* Not supported in Windows Server 2012 R2.

Note:

The VDA does not support DHE ciphersuites (for example, TLS_DHE_RSA_WITH_AES_256_GCM_SHA384, TLS_DHE_RSA_WITH_AES_256_CBC_SHA, TLS_DHE_RSA_WITH_AES_128_GCM_SHA256, and TLS_DHE_RSA_WITH_AES_128_CBC_SHA.) If selected by Windows, they may not be used by Receiver.

If you are using a Citrix Gateway, refer to the Citrix ADC documentation for information on cipher suite support for back-end communication. For information on TLS cipher suite support, see [Ciphers available on the Citrix ADC appliances](#). For information on DTLS cipher suite support, see [DTLS cipher support](#).

Requesting and installing a certificate

1. On the VDA, open the MMC console and add the Certificates snap-in. When prompted select Computer account.
2. Expand **Personal > Certificates**, then use the context menu command **All Tasks > Request New Certificate**.
3. Click **Next** to begin, and **Next** to confirm that you are acquiring the certificate from Active Directory enrollment.
4. Select the template for Server Authentication certificate. Both the default Windows **Computer** or **Web Server Exportable** are acceptable. If the template has been set up to automatically provide the values for Subject, you can click **Enroll** without providing more details.

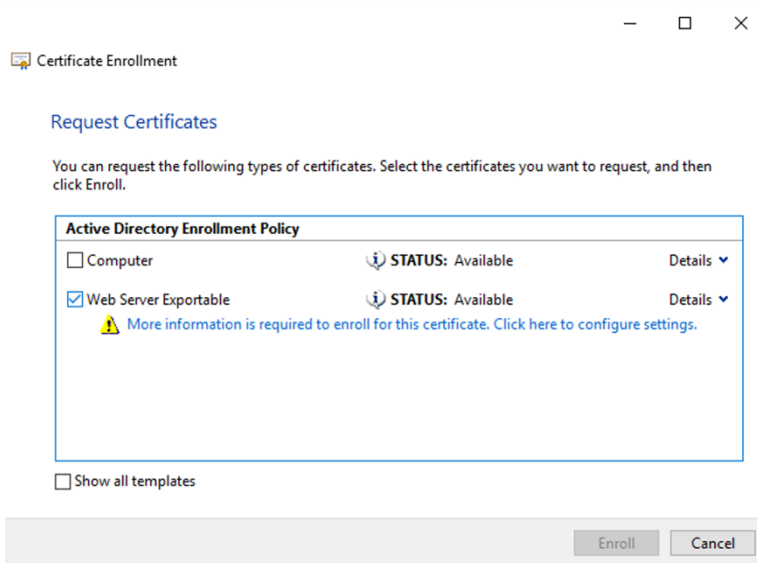

5. To provide more details for the certificate template, click **Details** and configure the following:

Subject name —select type **Common name** and add the FQDN of the VDA

Alternative name —select type **DNS** and add the FQDN of the VDA

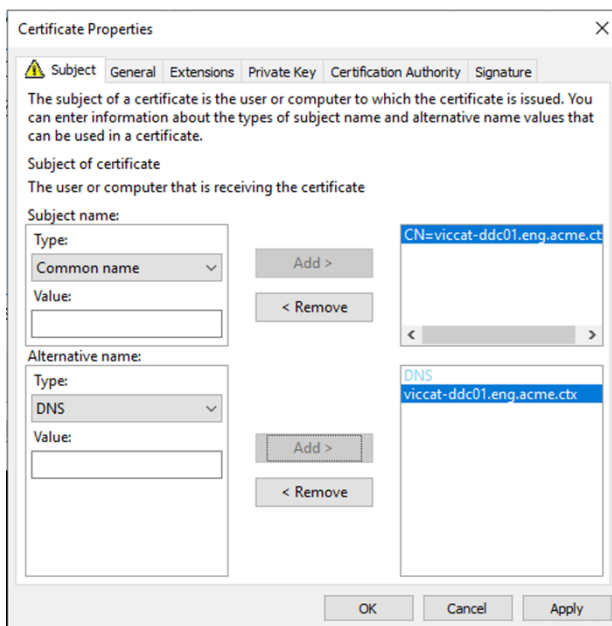

Note:

Use Active Directory Certificate Services Certificate Auto-Enrollment to automate issuing and deploying certificates to the VDAs. This is described in <https://support.citrix.com/article/CTX205473>.

You can use wildcard certificates to allow a single certificate to secure multiple VDAs:

Subject name —select type **Common name** and enter the *.primary.domain of the VDAs

Alternative name —select type **DNS** and add the *.primary.domain of the VDAs

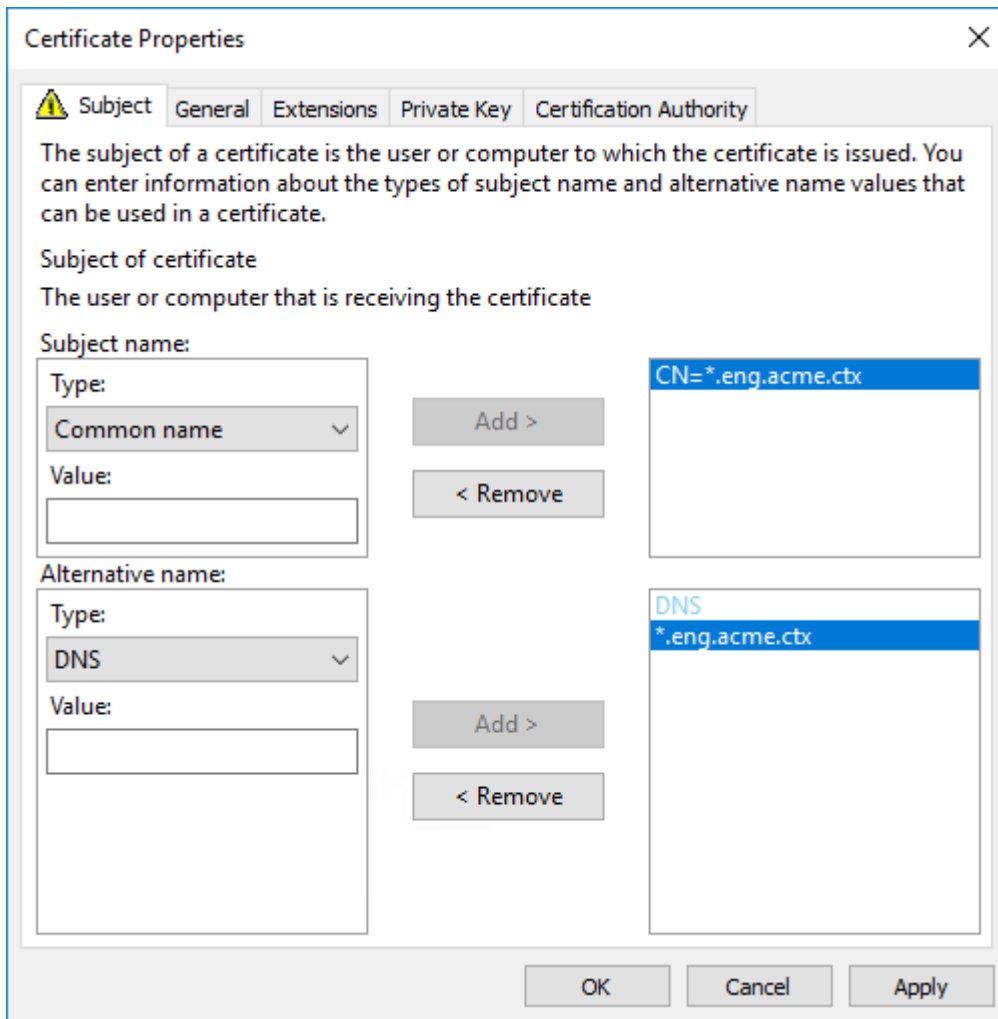

You can use SAN certificates to allow a single certificate to secure multiple specific VDAs:

Subject name —select type **Common name** and enter a string to help identify the certificate usage

Alternative name —select type **DNS** and add an entry for the FQDN of each VDA. Keep the number of Alternative names to a minimum to ensure optimal TLS negotiation.

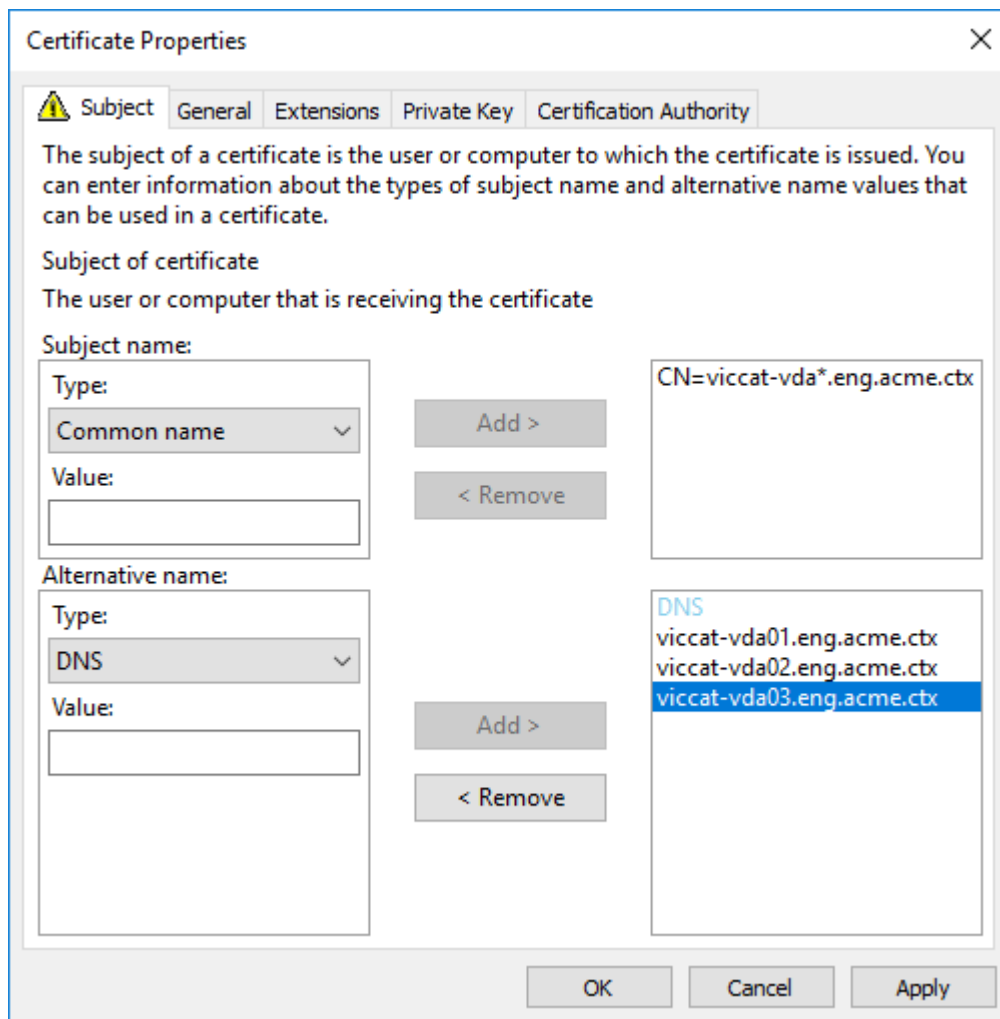

Note:

Both wildcard and SAN certificates require **Make private key exportable** on the Private Key tab to be selected:

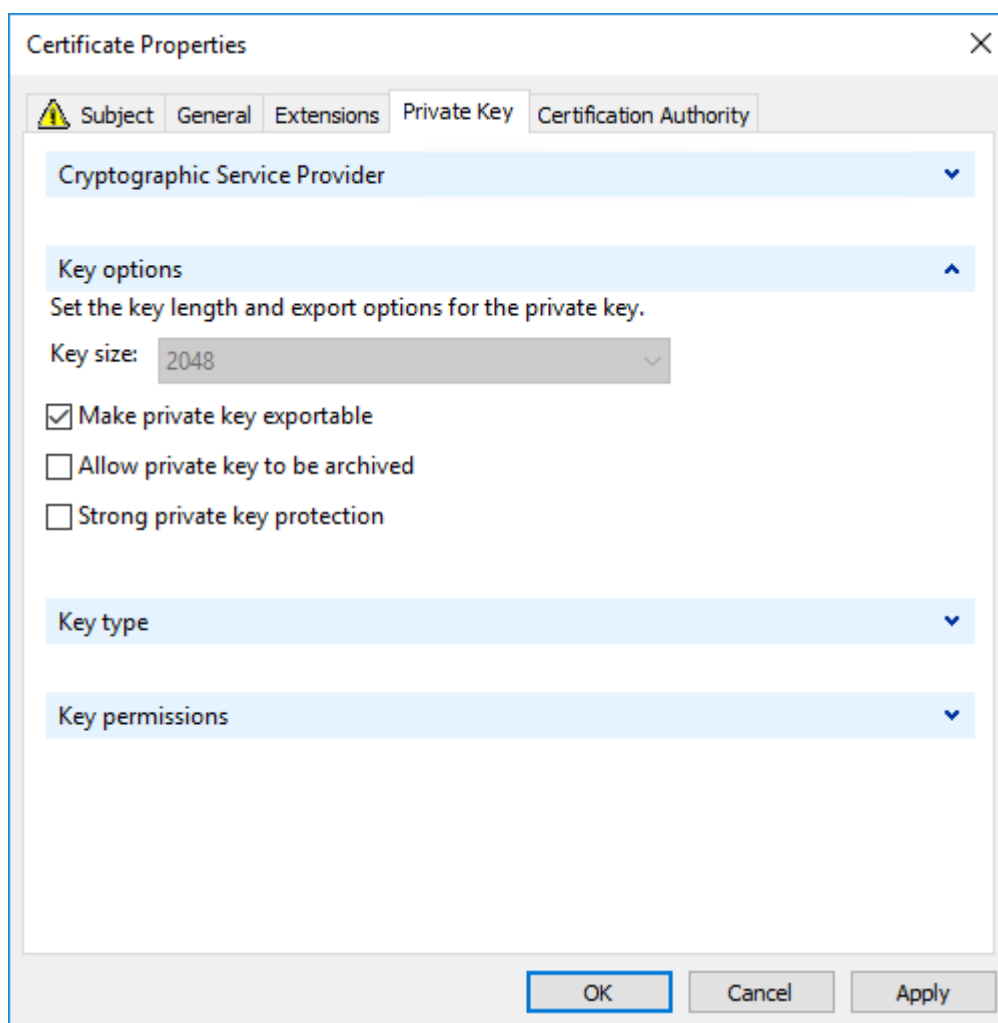

Configure TLS on a VDA using the PowerShell script

Install the TLS Certificate in the Local Computer > Personal > Certificates area of the certificate store. If more than one certificate resides in that location, supply the thumbprint of the certificate to the PowerShell script.

Note:

Starting with XenApp and XenDesktop 7.16 LTSR, the PowerShell script finds the correct certificate based on the FQDN of the VDA. You do not need to supply the thumbprint when only a single certificate is present for the VDA FQDN.

The Enable-VdaSSL.ps1 script enables or disables the TLS listener on a VDA. This script is available in the *Support > Tools > SslSupport* folder on the installation media.

When you enable TLS, DHE cipher suites are disabled. ECDHE cipher suites are not affected.

When you enable TLS, the script disables all existing Windows Firewall rules for the specified TCP port. It then adds a new rule that allows the ICA Service to accept incoming connections only on the TLS TCP and UDP ports. It also disables the Windows Firewall rules for:

- Citrix ICA (default: 1494)
- Citrix CGP (default: 2598)
- Citrix WebSocket (default: 8008)

The effect is that users can only connect using TLS or DTLS. They cannot use ICA/HDX, ICA/HDX with Session Reliability, or HDX over WebSocket, without TLS or DTLS.

Note:

DTLS is not supported with ICA/HDX Audio over UDP Real-time Transport, or with ICA/HDX Framework.

See [Network ports](#).

The script contains the following syntax descriptions, plus extra examples; you can use a tool such as Notepad++ to review this information.

Important:

Specify either the Enable or Disable parameter, and the CertificateThumbPrint parameter. The other parameters are optional.

```
Syntax Enable-VdaSSL { -Enable | -Disable } -CertificateThumbPrint "<thumbprint>" [-SSLPort <port>] [-SSLMinVersion "<min-ssl-version>"] [-SSLCipherSuite "\<suite>"]
```

| Parameter | Description |
|-----------|--|
| Enable | Installs and enables the TLS listener on the VDA. Either this parameter or the Disable parameter is required. |
| Disable | Disables the TLS listener on the VDA. Either this parameter or the Enable parameter is required. If you specify this parameter, no other parameters are valid. |

| Parameter | Description |
|--------------------------|--|
| CertificateThumbPrint "" | Thumbprint of the TLS certificate in the certificate store, enclosed in quotation marks. The script uses the specified thumbprint to select the certificate you want to use. If this parameter is omitted, an incorrect certificate is selected. |
| SSLPort | TLS port. Default: 443 |
| SSLMinVersion "" | Minimum TLS protocol version, enclosed in quotation marks. Valid values: "TLS_1.0" (default), "TLS_1.1", and "TLS_1.3". |
| SSLCipherSuite "" | TLS cipher suite, enclosed in quotation marks. Valid values: "GOV", "COM", and "ALL"(default). |

Examples The following script installs and enables the TLS protocol version value. The thumbprint (represented as "12345678987654321" in this example) is used to select the certificate to use.

```
1 Enable-VdaSSL -Enable -CertificateThumbPrint "12345678987654321"
```

The following script installs and enables the TLS listener, and specifies TLS port 400, the GOV cipher suite, and a minimum TLS 1.2 protocol value. The thumbprint (represented as "12345678987654321" in this example) is used to select the certificate to use.

```
1 Enable-VdaSSL -Enable
2 -CertificateThumbPrint "12345678987654321"
3 -SSLPort 400 -SSLMinVersion "TLS_1.3"
4 -SSLCipherSuite "All"
```

The following script disables the TLS listener on the VDA.

```
1 Enable-VdaSSL -Disable
```

Manually configure TLS on a VDA

When configuring TLS on a VDA manually, you grant generic read access to the private key of the TLS certificate for the appropriate service on each VDA: NT SERVICE\PorticaService for a VDA for Windows Single-session OS, or NT SERVICE\TermService for a VDA for Windows Multi-session OS. On the machine where the VDA is installed:

STEP 1. Launch the Microsoft management console (MMC): Start > Run > mmc.exe.

STEP 2. Add the Certificates snap-in to the MMC:

1. Select File > Add/Remove Snap-in.
2. Select Certificates and then click Add.
3. When prompted with “This snap-in will always manage certificates for:” choose “Computer account” and then click Next.
4. When prompted with “Select the computer you want this snap-in to manage” choose “Local computer” and then click Finish.

STEP 3. Under Certificates (Local Computer) > Personal > Certificates, right-click the certificate and then select All Tasks > Manage Private Keys.

STEP 4. The Access Control List Editor displays “Permissions for (FriendlyName) private keys” where (FriendlyName) is the name of your TLS certificate. Add one of the following services and give it Read access:

- For a VDA for Windows Single-session OS, “PORTICASERVICE”
- For a VDA for Windows Multi-session OS, “TERMSERVICE”

STEP 5. Double-click the installed TLS certificate. In the certificate dialog, select the Details tab and then scroll to the bottom. Click Thumbprint.

STEP 6. Run regedit and go to HKLM\SYSTEM\CurrentControlSet\Control\Terminal Server\Wds\icawd.

1. Edit the SSL Thumbprint key and copy the value of the TLS certificate’s thumbprint into this binary value. You can safely ignore unknown items in the Edit Binary Value dialog box (such as ‘0000’ and special characters).
2. Edit the SSLEnabled key and change the DWORD value to 1. (To disable SSL later, change the DWORD value to 0.)
3. If you want to change the default settings (optional), use the following in the same registry path:
SSLPort DWORD –SSL port number. Default: 443.
SSLMinVersion DWORD –1 = SSL 3.0, 2 = TLS 1.0, 3 = TLS 1.1, 4 = TLS 1.3. Default: 2 (TLS 1.0).
SSLCipherSuite DWORD –1 = GOV, 2 = COM, 3 = ALL. Default: 3 (ALL).

STEP 7. Ensure that the TLS TCP and UDP ports are that open in the Windows Firewall if they are not the default 443. (When you create the inbound rule in Windows Firewall, ensure its properties have the “Allow the connection” and “Enabled” entries selected.)

STEP 8. Ensure that no other applications or services (such as IIS) are using the TLS TCP port.

STEP 9. For VDAs for Windows Multi-session OS, restart the machine for the changes to take effect. (You do not need to restart machines containing VDAs for Windows Single-session OS.)

Important:

An extra step is necessary when the VDA is on Windows Server 2012 R2, Windows Server 2016, or Windows 10 Anniversary Edition or later supported release. This affects connections from Citrix Receiver for Windows (version 4.6 through 4.9), Citrix Workspace app for HTML5, and Citrix Workspace app for Chrome. This also includes connections using Citrix Gateway.

This step is also required for all connections using Citrix Gateway, for all VDA versions, if TLS between the Citrix Gateway and the VDA is configured. This affects all Citrix Receiver versions.

On the VDA (Windows Server 2012 R2, Windows Server 2016, or Windows 10 Anniversary Edition or later), using the Group Policy Editor, go to Computer Configuration > Policies > Administrative Templates > Network > SSL Configuration Settings > SSL Cipher Suite Order. Select the following order:

- 1 TLS_ECDHE_RSA_WITH_AES_256_GCM_SHA384_P384
- 2 TLS_ECDHE_RSA_WITH_AES_256_GCM_SHA384_P256
- 3 TLS_ECDHE_RSA_WITH_AES_256_CBC_SHA384_P384
- 4 TLS_ECDHE_RSA_WITH_AES_256_CBC_SHA384_P256
- 5 TLS_ECDHE_RSA_WITH_AES_128_CBC_SHA_P384
- 6 TLS_ECDHE_RSA_WITH_AES_128_CBC_SHA_P256

Note:

The first six items also specify the elliptic curve, P384 or P256. Ensure that “curve25519” is not selected. FIPS Mode does not prevent the use of “curve25519”.

When this Group Policy setting is configured, the VDA selects a cipher suite only if appears in both lists: the Group Policy list and the list for the selected compliance mode (COM, GOV, or ALL). The cipher suite must also appear in the list sent by the client (Citrix Workspace app or StoreFront).

This Group Policy configuration also affects other TLS applications and services on the VDA. If your applications require specific cipher suites, you may need to add them to this Group Policy list.

Important:

Even though Group Policy changes are shown when they are applied, Group Policy changes for TLS configuration only take effect after an operating system restart. Therefore, for pooled desktops, apply the Group Policy changes for TLS configuration to the base image.

Configure TLS on Delivery Groups

Complete this procedure for each Delivery Group that contains VDAs you have configured for TLS connections.

1. From Studio, open the PowerShell console.
2. Run **asnp Citrix.*** to load the Citrix product cmdlets.

3. Run **Get-BrokerAccessPolicyRule -DesktopGroupName '<delivery-group-name>'** | **Set-BrokerAccessPolicyRule -HdxSslEnabled \$true.**
4. Run **Set-BrokerSite -DnsResolutionEnabled \$true.**

Troubleshooting

If a connection error occurs, check the system event log on the VDA.

When using Citrix Workspace app for Windows, if you receive a connection error that indicates a TLS error, disable Desktop Viewer and then try connecting again. Although the connection still fails an explanation of the underlying TLS issue might be provided. For example, you specified an incorrect template when requesting a certificate from the certificate authority.)

Most configurations that use HDX Adaptive Transport work successfully with DTLS, including those using the latest versions of Citrix Workspace app, Citrix Gateway, and the VDA. Some configurations which use DTLS between Citrix Workspace app and Citrix Gateway, and which use DTLS between Citrix Gateway and the VDA, require additional action.

Additional action is needed if:

- the Citrix Receiver version supports HDX Adaptive Transport and DTLS: Receiver for Windows (4.7, 4.8, 4.9), Receiver for Mac (12.5, 12.6, 12.7), Receiver for iOS (7.2, 7.3.x) or Receiver for Linux (13.7)

and either of the following also applies:

- the Citrix Gateway version supports DTLS to the VDA, but the VDA version does not support DTLS (version 7.15 or earlier),
- the VDA version supports DTLS (version 7.16 or later), but the Citrix Gateway version does not support DTLS to the VDA.

To avoid connections from Citrix Receiver failing, do one of the following:

- update Citrix Receiver, to Receiver for Windows version 4.10 or later, Receiver for Mac 12.8 or later, or Receiver for iOS version 7.5 or later; or,
- update the Citrix Gateway to a version that supports DTLS to the VDA; or,
- update the VDA, to version 7.16 or later; or,
- disable DTLS at the VDA; or,
- disable HDX Adaptive Transport.

Note:

A suitable update for Receiver for Linux is not yet available. Receiver for Android (version 3.12.3) does not support HDX Adaptive Transport and DTLS via Citrix Gateway, and is therefore not af-

ected.

To disable DTLS at the VDA, modify the VDA firewall configuration to disable UDP port 443. See [Network ports](#).

Communication between Controller and VDA

Windows Communication Framework (WCF) message-level protection secures communication between the Controller and the VDA. Extra transport-level protection using TLS is not required. The WCF configuration uses Kerberos for mutual authentication between the Controller and VDA. Encryption uses AES in CBC mode with a 256-bit key. Message integrity uses SHA-1.

According to Microsoft, the Security [protocols](#) used by WCF conform to standards from OASIS (Organization for the Advancement of Structured Information Standards), including WS-SecurityPolicy 1.2. Additionally, Microsoft states that WCF supports all algorithm suites listed in [Security Policy 1.2](#).

Communication between the Controller and VDA uses the basic256 algorithm suite, whose algorithms are as stated above.

TLS and HTML5 video redirection, and browser content redirection

You can use HTML5 video redirection and browser content redirection to redirect HTTPS websites. The JavaScript injected into those websites must establish a TLS connection to the Citrix HDX HTML5 Video Redirection Service running on the VDA. To achieve this, the HTML5 Video Redirection Service generates two custom certificates in the certificate store on the VDA. Stopping the service removes the certificates.

The HTML5 video redirection policy is disabled by default.

The browser content redirection is enabled by default.

For more information on HTML5 video redirection, see [Multimedia policy settings](#).

Transport Layer Security (TLS) on Universal Print Server

December 19, 2023

The Transport Layer Security (TLS) protocol is supported for TCP-based connections between the Virtual Delivery Agent (VDA) and the Universal Print Server.

Warning:

For tasks that include working in the Windows registry—editing, the registry incorrectly can cause serious problems that may require you to reinstall your operating system. Citrix cannot guarantee that problems resulting from the incorrect use of Registry Editor can be solved. Use Registry Editor at your own risk. Be sure to back up the registry before you edit it.

Types of printing connections between the VDA and Universal Print Server

Cleartext connections

The following connections related to printing originate from the VDA and connect to ports on the Universal Print Server. These connections are made only when the **SSL enabled** policy setting is set to **Disabled** (the default).

- Cleartext print web service connections (TCP port 8080)
- Cleartext print data stream (CGP) connections (TCP port 7229)

The Microsoft support article [Service overview and network port requirements for Windows](#) describes the ports used by the Microsoft Windows Print Spooler Service. The SSL/TLS settings in this document do not apply to the NetBIOS and RPC connections made by the Windows Print Spooler service. The VDA uses the Windows Network Print Provider (win32spl.dll) as a fallback if the **Universal Print Server enable** policy setting is set to **Enabled with fallback to Windows’ native remote printing**.

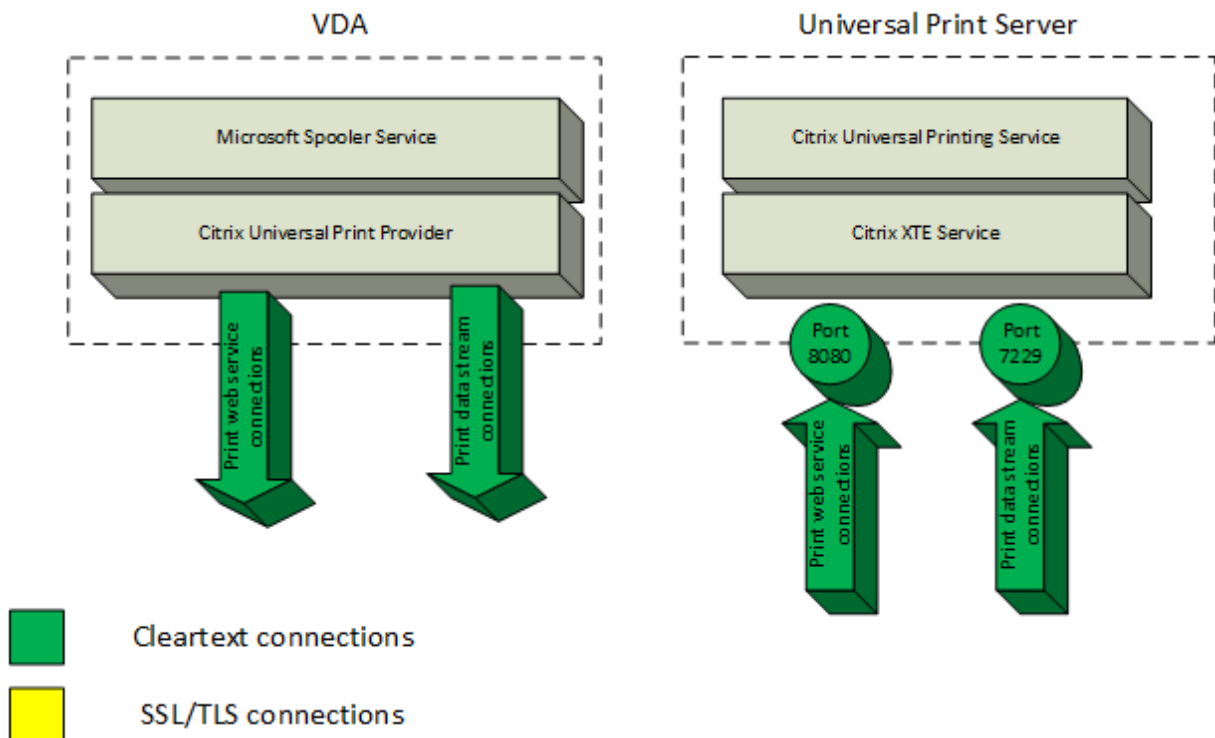

Encrypted connections

These SSL/TLS connections related to printing originate from the VDA and connect to ports on the Universal Print Server. These connections are made only when the **SSL enabled** policy setting is set to **Enabled**.

- Encrypted print web service connections (TCP port 8443)
- Encrypted print data stream (CGP) connections (TCP port 443)

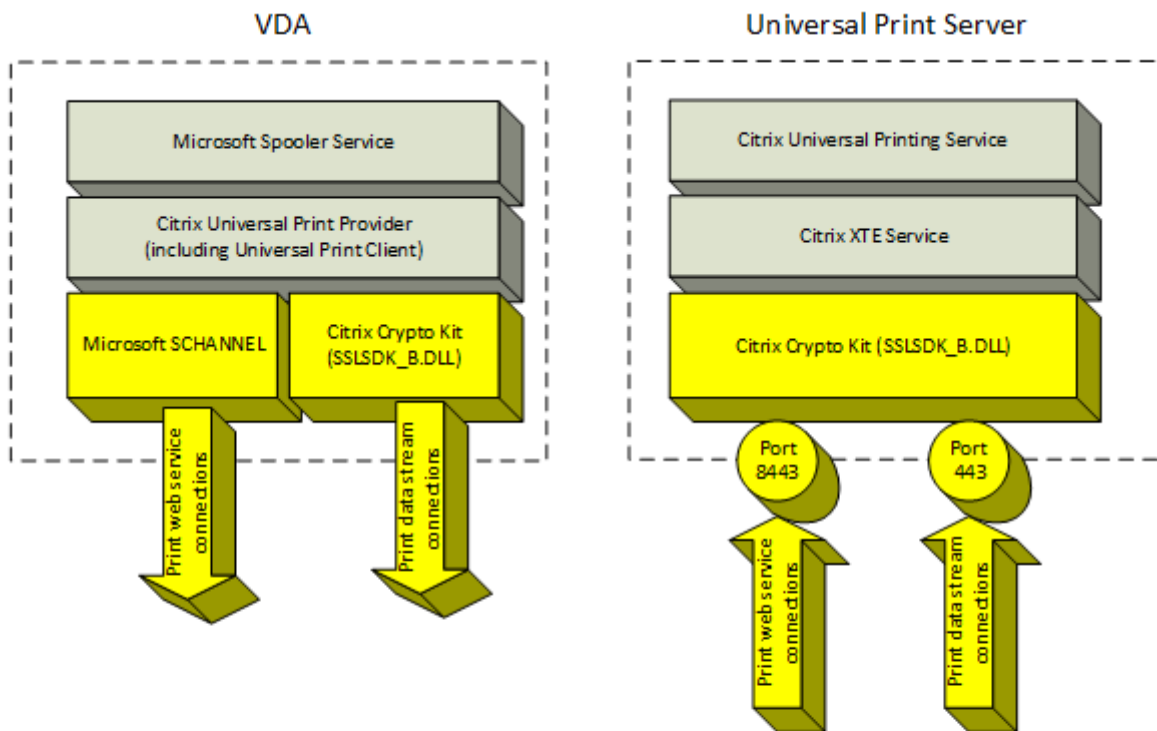

- Cleartext connections
- SSL/TLS connections

SSL/TLS client configuration

The VDA functions as the SSL/TLS client.

Use Microsoft Group Policy and the registry to configure Microsoft SCHANNEL SSP for encrypted print web service connections (TCP port 8443). The Microsoft support article [TLS Registry Settings](#) describes the registry settings for Microsoft SCHANNEL SSP.

Using the Group Policy Editor on the VDA, go to **Computer Configuration > Administrative Templates > Network > SSL Configuration Settings > SSL Cipher Suite Order**. Select the following order when TLS 1.3 is set:

TLS_AES_256_GCM_SHA384
TLS_AES_128_GCM_SHA256

Select the following order when TLS 1.2 is set:

TLS_ECDHE_RSA_WITH_AES_256_GCM_SHA384_P384
TLS_ECDHE_RSA_WITH_AES_256_GCM_SHA384_P256
TLS_ECDHE_RSA_WITH_AES_256_CBC_SHA384_P384
TLS_ECDHE_RSA_WITH_AES_256_CBC_SHA384_P256
TLS_ECDHE_RSA_WITH_AES_128_CBC_SHA_P384
TLS_ECDHE_RSA_WITH_AES_128_CBC_SHA_P256

Note:

When this Group Policy setting is configured, the VDA selects a cipher suite for encrypted print web service connections (default port: 8443) only if the connections appear in both SSL cipher suite lists:

- Group Policy SSL cipher suite order list
- List corresponding to the selected SSL Cipher Suite policy setting (COM, GOV, or ALL)

This Group Policy configuration also affects other TLS applications and services on the VDA. If your applications require specific cipher suites, you might need to add them to this Group Policy Cipher Suite Order list.

Important:

Group Policy changes for TLS configuration take effect only after an operating system restart.

Use a Citrix policy to configure SSL/TLS settings for encrypted print data stream (CGP) connections (TCP port 443).

SSL/TLS server configuration

The Universal Print Server functions as the SSL/TLS server.

Use the `Enable-UpsSsl.ps1` PowerShell script to configure SSL/TLS settings.

Install the TLS server certificate on the Universal Print Server

For HTTPS, the Universal Print Server supports TLS features by using server certificates. Client certificates are not used. Use Microsoft Active Directory Certificate Services or another certification author-

ity to request a certificate for the Universal Print Server.

Keep in mind the following considerations when enrolling/requesting a certificate using Microsoft Active Directory Certificate Services:

1. Place the certificate in the Local Computer **Personal** certificate store.
2. Set the **Common Name** attribute of the Subject Distinguished Name (Subject DN) of the certificate to the fully qualified domain name (FQDN) of the Universal Print Server. Specify this in the certificate template.
3. Set the Cryptographic Service Provider (CSP) used to generate the certificate request and private key to **Microsoft Enhanced RSA and AES Cryptographic Provider (Encryption)**. Specify this in the certificate template.
4. Set the Key Size to at least 2048 bits. Specify this in the certificate template.

Configuring SSL on the Universal Print Server

The XTE Service on the Universal Print Server listens for incoming connections. It functions as an SSL server when SSL is enabled. The incoming connections have two types: print web service connections, which contain printing commands, and print data stream connections, which contain print jobs. SSL can be enabled on these connections. SSL protects the confidentiality and integrity of these connections. By default, SSL is disabled.

The PowerShell script used to configure SSL is on the installation media and has this file name: `\Support\Tools\SslSupport\Enable-UpsSsl.ps1`.

Configuring listening port numbers on the Universal Print Server

These are the default ports for the XTE Service:

- Cleartext print web service (HTTP) TCP port: 8080
- Cleartext print data stream (CGP) TCP port: 7229
- Encrypted print web service (HTTPS) TCP port: 8443
- Encrypted print data stream (CGP) TCP port: 443

To change the ports used by the XTE Service on the Universal Print Server, run the following commands in PowerShell as administrator (see the later section for notes on the usage of the `Enable-UpsSsl.ps1` PowerShell script):

1. `Stop-Service CitrixXTEServer, UpSvc`
2. `Enable-UpsSsl.ps1 -Enable -HTTPSPort <port> -CGPSSLPort <port>` or `Enable-UpsSsl.ps1 -Disable -HTTPSPort <port> -CGPPort <port>`
3. `Start-Service CitrixXTEServer`

TLS settings on Universal Print Server

If you have multiple Universal Print Servers in a load-balanced configuration, ensure that the **TLS** settings are configured consistently across all Universal Print Servers.

When you configure TLS on Universal Print Server, permissions on the installed TLS certificate are changed, giving the Universal Printing Service read access to the certificate's private key, and informing the Universal Printing Service of the following:

- Which certificate in the certificate store to use for TLS.
- Which TCP port numbers to use for TLS connections.

The Windows Firewall (if enabled) must be configured to allow incoming connections on these TCP ports. This configuration is done for you when you use the Enable-UpsSsl.ps1 PowerShell script.

- Which versions of the TLS protocol to allow.

Universal Print Server supports TLS protocol versions 1.3 and 1.2. Specify the minimum allowed version.

The default TLS protocol version is 1.2.

Note:

TLS 1.1 and 1.0 are no longer supported from Citrix Virtual Apps and Desktops version 2311.

- Which TLS cipher suites to allow.

A cipher suite selects the cryptographic algorithms that are used for a connection. VDAs and Universal Print Server can support different sets of cipher suites. When a VDA connects and sends a list of supported TLS cipher suites, the Universal Print Server matches one of the client's cipher suites with one of the cipher suites in its own list of configured cipher suites and accepts the connection. If there is no matching cipher suite, the Universal Print Server rejects the connection.

The Universal Print Server supports the following sets of cipher suites named GOV(ernment), COM(mercial), and ALL for the OPEN, FIPS, and SP800-52 native Crypto Kit modes. The acceptable cipher suites also depend on the **SSL FIPS Mode** policy setting and on the Windows FIPS Mode. See this [Microsoft support article](#) for information about Windows FIPS mode.

| Cipher suite (in decreasing priority order) | OPEN ALL | OPEN COM | OPEN GOV | FIPS ALL | FIPS COM | FIPS GOV | SP800-52 ALL | SP800-52 COM | SP800-52 GOV |
|---|----------|----------|----------|----------|----------|----------|--------------|--------------|--------------|
| TLS_ECDHE_RSA_AES256_GCM_SHA384 | | | X | X | | X | X | | X |
| TLS_ECDHE_RSA_AES256_CBC_SHA384 | | | X | X | | X | X | | X |
| TLS_ECDHE_RSA_AES256_CBC_SHA | X | | | X | X | | X | X | |

Configure TLS on a Universal Print Server using the PowerShell script

Install the TLS Certificate in the **Local Computer > Personal > Certificates** area of the certificate store. If more than one certificate resides in that location, supply the thumbprint of the certificate to the `Enable-UpsSsl.ps1` PowerShell script.

Note:

The PowerShell script finds the correct certificate based on the FQDN of the Universal Print Server. You do not need to supply the certificate thumbprint when only a single certificate is present for the Universal Print Server FQDN.

The `Enable-UpsSsl.ps1` script enables or disables TLS connections originating from the VDA to the Universal Print Server. This script is available in the **Support > Tools > SslSupport** folder on the installation media.

When you enable TLS, the script disables all existing Windows Firewall rules for the Universal Print Server’s TCP ports. It then adds new rules that allow the XTE Service to accept incoming connections only on the TLS TCP and UDP ports. It also disables the Windows Firewall rules for:

- Cleartext print web service connections (default: 8080)
- Cleartext print data stream (CGP) connections (default: 7229)

The effect is that the VDA can make these connections only when using TLS.

Note:

Enabling TLS does not affect Windows Print Spooler RPC/SMB connections originating from the

VDA and going to the Universal Print Server.

Important:

Specify either **Enable** or **Disable** as the first parameter. The CertificateThumbprint parameter is optional if only one certificate in the Local Computer Personal certificate store has the Universal Print Server's FQDN. The other parameters are optional.

Syntax

```
1 Enable-UpsSSL.ps1 -Enable [-HTTPPort <port>] [-CGPPort <port>] [-
  HTTPSPort <port>] [-CGPSSLPort <port>] [-SSLMinVersion <version>] [-
  SSLCipherSuite <name>] [-CertificateThumbprint <thumbprint>] [-
  FIPSMODE <Boolean>] [-ComplianceMode <mode>]
2 Enable-UpsSSL.ps1 -Disable [-HTTPPort <portnum>] [-CGPPort <portnum>]
```

| Parameter | Description |
|--------------------------------------|--|
| Enable | Enables SSL/TLS on the XTE Server. Either this parameter or the Disable parameter is required. |
| Disable | Disables SSL/TLS on the XTE Server. Either this parameter or the Enable parameter is required. |
| CertificateThumbprint "<thumbprint>" | Thumbprint of the TLS certificate in the Local Computer Personal certificate store, enclosed in quotation marks. The script uses the specified thumbprint to select the certificate you want to use. |
| HTTPPort <port> | Cleartext print web service (HTTP/SOAP) port.
Default: 8080 |
| CGPPort <port> | Cleartext print data stream (CGP) port. Default: 7229 |
| HTTPSPort <port> | Encrypted print web service (HTTPS/SOAP) port.
Default: 8443 |
| CGPSSLPort <port> | Encrypted print data stream (CGP) port. Default: 443 |
| SSLMinVersion "<version>" | Minimum TLS protocol version, enclosed in quotation marks. Valid values: "TLS_1.2" and "TLS_1.3". Default: TLS_1.2. |
| SSLCipherSuite "<name>" | Name of TLS cipher suite package, enclosed in quotation marks. Valid values: "GOV", "COM", and "ALL"(default). |

| Parameter | Description |
|--------------------|--|
| FIPSMODE <Boolean> | Enables or disables FIPS 140 mode in the XTE Server. Valid values: \$true to enable FIPS 140 mode, \$false to disable FIPS 140 mode. |

Examples

The following script enables TLS. The thumbprint (represented as “12345678987654321” in this example) is used to select the certificate to use.

```
Enable-UpsSsl.ps1 -Enable -CertificateThumbprint "12345678987654321"
```

The following script disables TLS.

```
Enable-UpsSsl.ps1 -Disable
```

Configuring FIPS mode

Enabling US Federal Information Processing Standards (FIPS) mode ensures that only FIPS 140 compliant cryptography is used for Universal Print Server encrypted connections.

Configure FIPS mode on the server before configuring FIPS mode on the client.

Consult Microsoft’s documentation site for enabling/disabling Windows FIPS mode.

Enabling FIPS mode on the client

On the Delivery Controller, run Web Studio and set the **SSL FIPS Mode** Citrix policy setting to **Enabled**. Enable the Citrix policy.

Do this on each VDA:

1. Enable Windows FIPS mode.
2. Restart the VDA.

Enabling FIPS mode on the server

Do this on each Universal Print Server:

1. Enable Windows FIPS mode.

2. Run this PowerShell command as Administrator: `stop-service CitrixXTEServer, UpSvc`
3. Run the `Enable-UpsSsl.ps1` script with the `-Enable -FIPSMode $true` parameters.
4. Restart the Universal Print Server.

Disabling FIPS mode on the client

On Web Studio, set the **SSL FIPS Mode** Citrix policy setting to **Disabled**. Enable the Citrix policy. You can also delete the **SSL FIPS Mode** Citrix policy setting.

Do this on each VDA:

1. Disable Windows FIPS mode.
2. Restart the VDA.

Disabling FIPS mode on the server

Do this on each Universal Print Server:

1. Disable Windows FIPS mode.
2. Run this PowerShell command as Administrator: `stop-service CitrixXTEServer, UpSvc`
3. Run the `Enable-UpsSsl.ps1` script with the `-Enable -FIPSMode $false` parameters.
4. Restart the Universal Print Server.

Note:

FIPS mode is not supported when the SSL protocol version is set to TLS 1.3.

Configuring SSL/TLS protocol version

The default SSL/TLS protocol version is TLS 1.2. TLS 1.2 and TLS 1.3 are the recommended SSL/TLS protocol versions for production use. For troubleshooting, it might be necessary to temporarily change the SSL/TLS protocol version in a non-production environment.

SSL 2.0 and SSL 3.0 are not supported on the Universal Print Server.

Setting SSL/TLS protocol version on the server

Do this on each Universal Print Server:

1. Run this PowerShell command as Administrator: `stop-service CitrixXTEServer, UpSvc`
2. Run the `Enable-UpsSsl.ps1` script with the `-Enable -SSLMinVersion` version parameters. Remember to set this back to TLS 1.2 or TLS 1.3 when you are done testing.
3. Restart the Universal Print Server.

Setting SSL/TLS protocol version on the client

Do this on each VDA:

1. On the Delivery Controller, set the **SSL Protocol Version** policy setting to the desired protocol version and enable the policy.
2. The Microsoft support article [TLS Registry Settings](#) describes the registry settings for Microsoft SCHANNEL SSP. Enable the client-side **TLS 1.2 or TLS 1.3** using the registry settings.

Important:

Remember to restore the registry settings to their original values when you are done testing.

3. Restart the VDA.

Troubleshooting

If a connection error occurs, check the `C:\Program Files (x86)\Citrix\XTE\logs\error.log` file on the Universal Print Server.

The error message **SSL handshake from client failed** appears in this log file if the SSL/TLS handshake fails. Such failures can occur if the SSL/TLS protocol version on the VDA and the Universal Print Server do not match.

Use the Universal Print Server FQDN in the following policy settings that contain Universal Print Server host names:

- Session printers
- Printer assignments
- Universal Print Servers for load balancing

Ensure that the system clock (date, time, and time zone) are correct on the Universal Print Servers and the VDAs.

Virtual channel allow list

March 1, 2024

The virtual channel allow list is a feature that allows you to control which non-Citrix virtual channels are allowed in your environment. By default, the virtual channel allow list feature is enabled. As a result, only Citrix virtual channels are allowed to open in Citrix Virtual Apps and Desktops sessions. If there is a need to use custom virtual channels, whether homegrown or from a third party, these need to be explicitly added to the allow list.

Configuration

The virtual channel allow list is enabled by default. You can configure this feature using the following settings in the Citrix policy:

- **Virtual channel allow list:** to enable or disable the feature and to add virtual channels to the list.
- **Virtual channel allow list log throttling:** sets the throttling period for the virtual channel allow list event logging.
- **Virtual channel allow list logging:** sets the logging level for the virtual channel allow list.

Adding virtual channels to the allow list

To add a virtual channel to the allow list, you need the following information:

1. The virtual channel name as defined in the code, which can be up to seven characters long. For example, `CTXCV1`.
2. The paths to the processes that open the virtual channel on the VDA machine. For example, `C:\Program Files\Application\run.exe`.

Once you have the required information, you must add the virtual channel to the allow list using the [Virtual channel allow list policy setting](#). To add a virtual channel to the list, enter the virtual channel name followed by a comma, and then the path to the process that accesses the virtual channel. If there are multiple processes, you can add these processes by separating each process with commas.

For single processes

Using the previous examples, add the following entry to the list:

```
CTXCV1,C:\Program Files\Application\run.exe
```

For multiple processes

If there are multiple processes, add the following entry to the list:

```
CTXVC1,C:\Program Files\Application\run.exe,C:\Program Files\Application\run2.exe
```

Using wildcards

The use of wildcards (*) is supported. You can use wildcards when the names of directories or executables change based on the version of the application, or if the third-party component is installed in the users' profiles.

You can use wildcards in the following scenarios:

- To replace the full directory name.
For example: `C:\Program Files\Application*\run1.exe`
- To replace part of the directory name.
For example: `C:\Program Files\Application\v*\run1.exe`
- To replace the executable's name.
For example: `C:\Program Files\Application\v1.2*.exe`
- To replace part of the executable's name.
For example: `C:\Program Files\Application\v1.2\run*.exe`

The following restrictions apply:

- The wildcard can only be used to replace a single directory. For example, if the executable is located in `C:\Program Files\Application\v1.2\run1.exe`
 - Allowed: `C:\Program Files\Application*\run1.exe`
 - Not allowed: `C:\Program Files*\run1.exe`
- Entries must contain the file name extension.
 - Allowed: `C:\Program Files\Application\v1.2*.exe`
 - Not allowed: `C:\Program Files\Application\v1.2*`
- All paths must be local.

Note:

- Network paths are not allowed.
- Wildcard support is available from Citrix Virtual Apps and Desktops 2206.
- Wildcard support is available in Citrix Virtual Apps and Desktops 2203 LTSR from CU2.

Using system environment variables

You can use system environment variables to simplify the definition of the trusted processes in your allow list. You can use any of the out-of-box variables, such as `%programfiles%`, `%programfiles(x86)%`, `%systemdrive%`, and `%systemroot%`.

You can also use custom environment variables as long as they are defined at the system level.

The following examples depict out-of-box environment variables:

- `%programfiles%\Application\v1.2\run.exe`
- `%programfiles%\Application*\run.exe`
- `%programfiles(x86)%\Application\v1.*\run.exe`

The following example depicts a custom system environment variable:

- Custom variable name: `app`
- Custom variable value: `%programfiles%\Application\`
- Allow list entry: `CTXCVC1,%app%\run.exe`

Note:

User environment variables are not supported.

Environment variable support is available from Citrix Virtual Apps and Desktops version 2209.

Obtain virtual channel names and processes

The easiest way to obtain the name of the virtual channel and the process that opens it on the VDA machine is to get the information from the developer or a third-party vendor that provided the virtual channel.

Alternatively, you can obtain information by applying the feature's logs and following these steps:

1. Once the client and server components of the custom virtual channel are in place, launch a virtual application or virtual desktop.
2. In the VDA machine's System event log, look for the custom virtual channel's name and the process that tried to open it. For more information on available events, see [Event logs](#).
3. Log out from the session.
4. Add an entry in the virtual channel allow list policy settings for the identified virtual channel and process.
5. Restart the machine.
6. Once the VDA is registered, run the virtual application or virtual desktop to validate that the custom virtual channels open successfully.

Considerations for Citrix virtual channels

All built-in Citrix virtual channels are trusted and allowed to open without further configuration. However, the following two features require explicit entries in the allow list because of external dependencies:

- Multimedia Redirection
- HDX RealTime Optimization Pack for Skype for Business

Multimedia Redirection

If you use a media player other than Windows Media Player as your system media player, you need to add it to the allow list as a trusted process. The following information is required for the allow list entry:

- Virtual channel name: `CTXMM`
- Process: Path to the media player used in your VDA machine. For example, `C:\Program Files (x86)\Windows Media Player\wmpplayer.exe`.
- Allow list entry: `CTXMM,C:\Program Files (x86)\Windows Media Player\wmpplayer.exe`

HDX RealTime Optimization Pack for Skype for Business

The following information is required for the allow list entry:

- Virtual channel name: `CTXRMEP`
- Process: Path to the Skype for Business executable in your VDA machine, which can vary based on the version of Skype for Business or if you used a custom installation path. For example, `C:\Program Files\Microsoft Office\root\Office16\lync.exe`.
- Allow list entry: `CTXRMEP,C:\Program Files\Microsoft Office\root\Office16\lync.exe`

WebSocket communication between VDA and Delivery Controller

January 29, 2024

This article describes how to set up a WebSocket connection for communication between VDAs and Delivery controllers.

Overview

The WebSocket protocol works over the Citrix Brokering Protocol and facilitates stable communication between Delivery Controllers and VDAs.

Using WebSocket protocol for communication offers the following benefits:

- Requires only the TLS port 443 for communication from the VDA to the Delivery Controller.
- Provides seamless and reliable communication channels between VDAs and Delivery Controllers.

How it works

The following section describes the workflow for the WebSocket connection between a Delivery Controller and a VDA:

1. Citrix Virtual Apps and Desktops admins initiate the process by provisioning VDAs using the Machine Creation Service (MCS).
2. During the MCS provisioning process, MCS generates public-private key pairs for each VDAs and registers the public keys with the FMA trust service on the Delivery Controller. MCS saves the public-private key pair as a file under the identity disk on the VDAs.
3. When the VDA machine boots up, the MCS agent installed on the VDA machine reads the key pair from the identity disk and writes this information to the VDA registry location.
4. The broker agent installed on the VDA reads the key pairs from the registry and generates an SSL-enabled WebSocket request to the Delivery Controller with the service key signed by the private key.
5. The delivery controller verifies the signed service key authorization header with the public key from the FMA trust service.
6. Once the verification is complete, the system establishes the WebSocket connection between the VDA and the Delivery Controller.

WebSocket support for AD-joined VDAs

Before you begin

1. Configure your site. For more information, see [Create a site](#).
2. Install TLS certificates on the Delivery Controllers. For more information, see [Install TLS server certificates on Controllers](#).
3. Install root CA and intermediate CA on VDA to trust the Delivery Controller.

Procedure

Follow the instructions to set up a WebSocket connection:

1. Enable WebSocket connection on the Delivery Controller. Run the following command on each Delivery Controller present on your site:

```
New-ItemProperty "HKLM:\SOFTWARE\Citrix\DesktopServer\WorkerProxy"  
-Name "WebSocket_Enabled"-PropertyType "DWord"-Value 1 -Force
```

Note:

Ensure that you restart the Delivery Controllers after enabling the WebSocket.

2. Create a machine catalog for AD-joined VDAs with MCS provisioning. For more information, see [Create machine catalog](#).
3. Create a delivery group and add your VDA to it. For more information, see [Create delivery groups](#).
4. Enable WebSocket connection on the VDA. Run the following command on the VDA:

```
New-ItemProperty "HKEY_LOCAL_MACHINE\SYSTEM\CurrentControlSet\  
Services\CitrixBrokerAgent\WebSocket"-Name "Enabled"-PropertyType  
"DWord"-Value 1 -Force
```

5. Verify the VDA machine registry to check whether the WebSocket connection is enabled or not. On the VDA registry, the value of Enable Key must be 1.

VDA Registry folder location:

```
HKEY_LOCAL_MACHINE\SYSTEM\CurrentControlSet\Services\CitrixBrokerAgent  
\WebSocket
```

HDX connectivity

February 19, 2024

Citrix HDX represents a broad set of technologies that deliver a high-definition experience to users of centralized applications and desktops, on any device and over any network.

HDX is designed around three technical principles:

- Intelligent redirection
- Adaptive compression
- Data de-duplication

Applied in different combinations, they optimize the IT and user experience, decrease bandwidth consumption, and increase user density per hosting server.

Within the HDX offering, you can connect over a unique, proprietary transport protocol, utilize the maximum transmission units when establishing sessions, and optimize connectivity with Citrix SD-WAN.

Adaptive transport

March 1, 2024

Adaptive Transport is a mechanism in Citrix Virtual Apps and Desktops that allows establishing connections for HDX sessions using a preferred transport protocol while providing a fallback to TCP if connectivity with the preferred protocol is unavailable.

The following transport protocols are supported:

- Enlightened Data Transport (EDT)
- Transmission Control Protocol (TCP)

Configuration

Adaptive Transport is enabled by default. You can configure Adaptive Transport to operate in the following modes:

- **Preferred:** (Default) The client attempts to connect with the preferred protocol and falls back to TCP if connectivity with the preferred protocol is unavailable.
- **Diagnostic mode:** The client only attempts to connect using the preferred protocol. Fall back to TCP is disabled.
- **Off:** The client only attempts to connect using TCP.

How it works

When **Adaptive Transport** is set to **Preferred**, the client attempts to connect to the session with both the preferred protocol and TCP in parallel. This allows optimizing the connection time if it's not possible to connect with the preferred protocol and the client must fall back to using TCP. If the connection is established using TCP, the client attempts to connect with the preferred protocol in the background every five minutes.

When **Adaptive Transport** is set to *Diagnostic mode*, the client connects to the session only with the preferred protocol. If the client is unable to establish a connection using the preferred protocol, it doesn't fall back to using TCP, and the connection fails.

When **Adaptive Transport** is set to *Off*, **Adaptive Transport** is disabled, and the client connects to the session using TCP only.

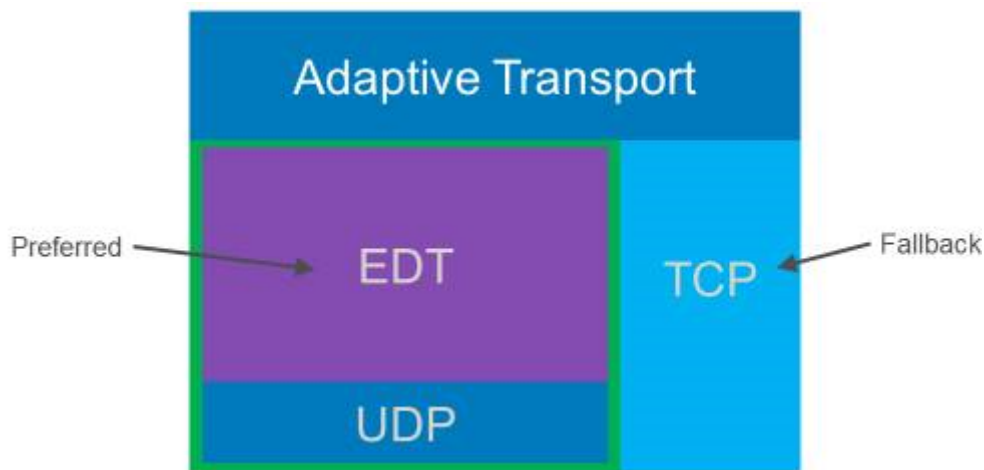
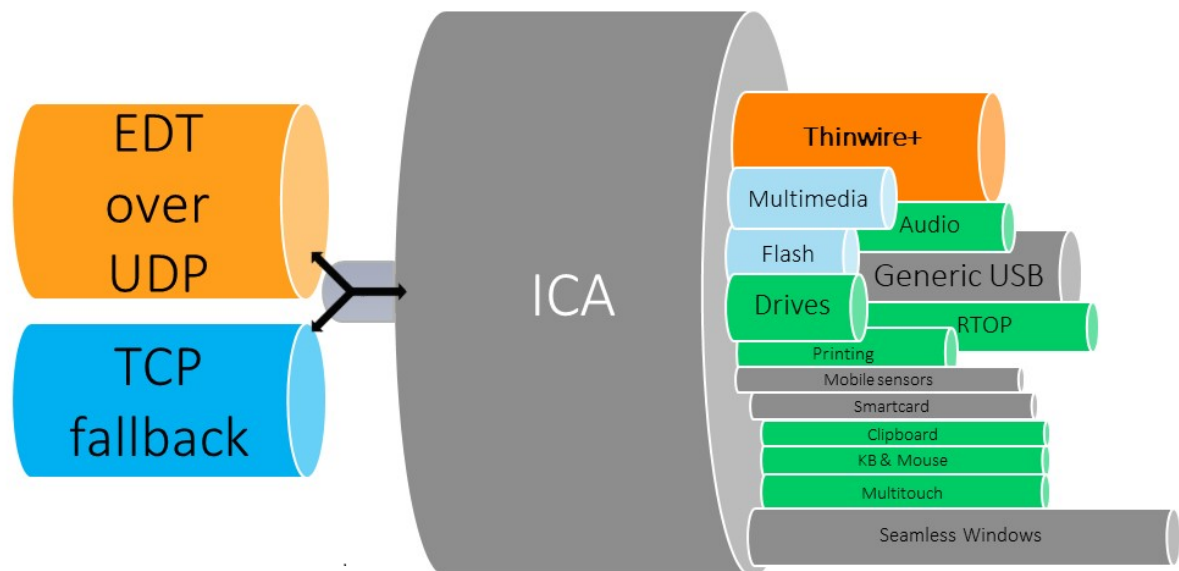

System requirements

The following are the requirements for using Adaptive Transport and EDT:

- Control plane
 - Citrix DaaS (formerly Citrix Virtual Apps and Desktops service)
 - Citrix Virtual Apps and Desktops 1912 or later

- Virtual Delivery Agent
 - Version 1912 or later (2308 or later recommended)
 - Version 2012 is the minimum required for using EDT with Citrix Gateway Service
- Citrix Workspace app
 - Windows: version 2209 or later
 - Linux: version 2211 or later
 - Mac: version 2210 or later
 - iOS: latest version available in the Apple App Store
 - Android: latest version available in Google Play
- Citrix NetScaler Gateway
 - 14.1.12.30 or later (recommended)
 - 13.1.17.42 or later

Network requirements

The following sections are the network requirements for using EDT with Adaptive Transport:

Session hosts

If your session hosts have a firewall such as Windows Defender Firewall, you must allow the following inbound traffic for internal connections.

| Description | Source | Protocol | Port |
|--|--------|----------|------|
| Internal connection - Session Reliability enabled | Client | UDP | 2598 |
| Internal connection - Session Reliability disabled | | | 1494 |
| Internal connection - HDX Direct or SSL VDA | | | 443 |

Note:

The VDA installer adds the appropriate inbound rules to the Windows Defender Firewall. If you use a different firewall, you must add the rules above.

Internal network

The following table depicts the firewall rules required for using EDT in your network:

| Description | Protocol | Source | Destination | Destination port |
|---|----------|----------------|-------------|------------------|
| Direct internal connection - Session Reliability enabled | UDP | Client network | VDA network | 2598 |
| Direct internal connection - Session Reliability disabled | | | | 1494 |
| Direct internal connection - HDX | | | | 443 |
| Direct or VDA SSL | | | | |
| NetScaler Gateway | | NetScaler SNIP | | 2598 |
| NetScaler Gateway - VDA SSL | | | | 443 |

Note:

If you are using Citrix Gateway Service, you must enable **Rendezvous** to use EDT as your transport protocol. See the [Rendezvous](#) documentation for system and network requirements.

Enlightened Data Transport

February 27, 2024

Enlightened Data Transport (EDT) is a Citrix-proprietary transport protocol built on top of User Datagram Protocol (UDP). It delivers a superior user experience on challenging long-haul connections while maintaining server scalability. EDT improves data throughput for all ICA virtual channels on unreliable networks, providing a better and more consistent user experience.

When **Adaptive Transport** is enabled, EDT is the preferred protocol.

Things to know

- **Session Reliability** must be enabled to use **MTU Discovery** and EDT with NetScaler Gateway and Citrix Gateway Service.
- Packet fragmentation can cause performance degradation or even failure to open sessions in some cases. To prevent this, you must adjust the EDT MTU to a value adequate for your networks. You can use EDT MTU Discovery or a manual workaround described in [How to configure MSS when using EDT on networks with non-standard MTU](#).
- For details on enabling the use of EDT with NetScaler Gateway, see [Configure NetScaler Gateway to support Enlightened Data Transport](#).

EDT MTU Discovery

MTU Discovery allows EDT to automatically determine the Maximum Transmission Unit (MTU) when establishing a session. Doing so prevents EDT packet fragmentation that might result in performance degradation or failure to establish a session.

MTU Discovery is enabled by default. If you need to disable it, see [HDX features managed through the registry](#) for details.

Note:

- **Session Reliability** must be enabled for MTU Discovery to work.
- MTU Discovery with Multi-Stream ICA is available with VDA versions 2209 and later.

Troubleshooting

February 28, 2024

To confirm that EDT is being used as the transport protocol for the session, you can use Director or the `CtxSession.exe` command-line utility on the VDA.

In Director, look up the session and select **Details**. If the **Connection type** is **HDX** and the **Protocol** is **UDP**, EDT is being used as the transport protocol for the session.

Session Details

Session Control ▾ Shadow Send Message

| | |
|-------------------------------------|-----------|
| ID | 2 |
| Session State | Active |
| Application State | Desktop |
| Anonymous | No |
| Time in state | 0 minutes |
| Endpoint name | |
| Endpoint IP | |
| Connection type | HDX |
| Protocol | UDP |
| Citrix Workspace App Version | 21.5.0.48 |
| ICA RTT | 67 ms |
| ICA Latency | 65 ms |
| Launched via | n/a |
| Connected via | |

To use the CtxSession.exe utility, launch a Command Prompt or PowerShell within the session and run `ctxsession.exe`. To see verbose statistics, run `ctxsession.exe -v`. If EDT is in use, the transport protocol shows one of the following:

- **UDP > ICA** (Session Reliability disabled)
- **UDP > CGP > ICA** (Session Reliability enabled)
- **UDP > DTLS > CGP > ICA** (ICA is DTLS-encrypted end-to-end)

```
Administrator: Windows PowerShell
PS C:\windows\system32> ctxsession -v

Session Id 2:
Transport Protocols: UDP -> DTLS -> CGP -> ICA
  Local Address:
  Remote Address:
  Client Address:
Security Protocol: UNKNOWN VALUE - 131072
Security Cipher: 128 bit AES
Cipher Strength: 128 bits
ICA Encryption: Basic

EDT Reliable Statistics:
Bandwidth 121.777 Mbps, Send Rate 0 bps, Recv Rate 0 bps, RTT 65.531 ms
Sent 0, Sent Lost 0 (0.00%), Rcvd 0, Rcvd Lost 0 (0.00%)
Sent ACKs 0, Sent NAKs 0, Rcvd ACKs 0, Rcvd NAKs 0
Flow Window 16383, Congest Window 4050, Delivery Rate 7591
EDT MTU: 1400

ICA Statistics:
SentBandwidth (bps) = 6376 RecvBandwidth (bps) = 568
SentPreCompression = 1800688 RecvPreExpansion = 32864
SentPostCompression = 1429125 RecvPostExpansion = 137041
Compression Ratio % = 79 Expansion Ratio % = 23
LastLatency = 67 AverageLatency = 53
IcaBufferLength = 980
```

When sessions fail to connect with EDT

To troubleshoot **Adaptive Transport** and **EDT**, we suggest the following:

1. Review the [System requirements](#), [Network requirements](#), Known issues, and [Things to know](#), and ensure that all items have been addressed.
2. Check if there are Citrix policies in Studio or GPO overwriting the desired **HDX Adaptive Transport** setting.
3. Check if there are settings on the client overwriting the desired HDX Adaptive Transport setting. This can be a GPO preference, a setting configured using the optional Workspace app administrative template, or a manual configuration of the **HDXoverUDP** setting in the registry or client's configuration file.
4. On multi-session VDA machines, ensure that the UDP listeners are active. Open a command prompt in the VDA machine and run `netstat -a -p udp`. For more information, see [How to Confirm HDX Enlightened Data Transport Protocol](#).
5. Check if the appropriate firewall rules have been configured in both network firewalls and firewalls running on the VDA machines.
6. Launch a direct session internally, bypassing the NetScaler Gateway or Citrix Gateway Service, and check the protocol in use. If the session uses EDT, the VDA is ready to use EDT for external connections through NetScaler Gateway or Citrix Gateway Service.

7. If EDT works for direct internal connections and not for sessions going through NetScaler Gateway or Citrix Gateway Service:
 - Ensure that **Session Reliability** is enabled.
 - If using NetScaler Gateway, ensure that your configuration adheres to the required configuration outlined in [Configure NetScaler Gateway to support Enlightened Data Transport and HDX Insight](#).
8. If using Citrix Gateway Service, ensure that Rendezvous is enabled and working.
9. Check if your users' connections require a non-standard MTU. Connections with an effective MTU lower than 1500 bytes cause EDT packet fragmentation, which in turn can affect performance or even cause session launch failures. This issue is common when using VPNs, some Wi-Fi access points, and mobile networks, such as 4G and 5G. Ensure that you either have MTU Discovery enabled or are setting a custom MTU as outlined in [How to configure MSS when using EDT on networks with non-standing MTU](#).

Known issues

- Asymmetrical network paths can cause MTU Discovery to fail for connections that do not go through NetScaler Gateway or Citrix Gateway Service. To address this issue, upgrade to VDA version 2103 or later. [CVADHELP-16654]
- When using NetScaler Gateway, asymmetrical network paths can cause MTU Discovery to fail. This is due to an issue on Gateway that causes the Don't Fragment (DF) bit in the EDT packets' header not to be propagated. A fix for this issue is available, starting with firmware release 13.1 build 17.42. For details on how to enable the fix, see the [NetScaler Gateway](#) documentation. [CGOP-18438]
- MTU Discovery can fail for users that connect through a DS-Lite network. Some modems fail to honor the DF bit when packet processing is enabled, preventing MTU Discovery from detecting fragmentation. In this situation, the following are the available options:
 - Disable packet processing on the user's modem.
 - Disable **MTU Discovery** and use a hardcoded MTU as described in [How to configure MSS when using EDT on networks with non-standing MTU](#).
 - Disable **Adaptive Transport** to force sessions to use TCP. If only a subset of users are affected, consider disabling it on the client side so that other users can continue to use EDT.

HDX Direct (Preview)

December 20, 2023

When accessing Citrix-delivered resources, HDX Direct allows both internal and external client devices to establish a secure direct connection with the session host if direct communication is possible.

Important:

HDX Direct is currently in preview. This feature is provided without support and is not yet recommended for use in production environments. To submit feedback or report issues, use [this form](#).

System requirements

The following are the system requirements for using HDX Direct:

- Control plane
 - Citrix DaaS
 - Citrix Virtual Apps and Desktops 2311 or later
- Virtual Delivery Agent (VDA)
 - Windows: version 2311 or later
- Workspace app
 - Windows: version 2311 or later
- Access tier
 - Citrix Workspace with Citrix Gateway Service
 - Citrix Workspace with NetScaler Gateway
- Other
 - Adaptive Transport must be enabled for external direct connections

Network requirements

The following are the network requirements for using HDX Direct.

Session hosts

If your session hosts have a firewall such as Windows Defender Firewall, you must allow the following inbound traffic for internal connections.

| Description | Source | Protocol | Port |
|----------------------------|--------|----------|------|
| Direct internal connection | Client | TCP | 443 |
| Direct internal connection | Client | UDP | 443 |

Note:

The VDA installer adds the appropriate inbound rules to Windows Defender Firewall. If you use a different firewall, you must add the rules above.

Client network

The following table describes the client network for internal and external users.

Internal users

| Description | Protocol | Source | Source port | Destination | Destination port |
|----------------------------|----------|----------------|-------------|-------------|------------------|
| Direct internal connection | TCP | Client network | 1024–65535 | VDA network | 443 |
| Direct internal connection | UDP | Client network | 1024–65535 | VDA network | 443 |

External users

| Description | Protocol | Source | Source port | Destination | Destination port |
|----------------------------|----------|----------------|-------------|---------------------------|------------------|
| STUN (external users only) | UDP | Client network | 1024–65535 | Internet (see note below) | 3478, 19302 |

| Description | Protocol | Source | Source port | Destination | Destination port |
|--------------------------|----------|----------------|-------------|---------------------------------|------------------|
| External user connection | UDP | Client network | 1024–65535 | Data center's public IP address | 1024–65535 |

Data center network

The following table describes the data center network for internal and external users.

Internal users

| Description | Protocol | Source | Source port | Destination | Destination port |
|----------------------------|----------|----------------|-------------|-------------|------------------|
| Direct internal connection | TCP | Client network | 1024–65535 | VDA network | 443 |
| Direct internal connection | UDP | Client network | 1024–65535 | VDA network | 443 |

External users

| Description | Protocol | Source | Source port | Destination | Destination port |
|----------------------------|----------|------------------------|-------------|---------------------------|------------------|
| STUN (external users only) | UDP | VDA network | 1024–65535 | Internet (see note below) | 3478, 19302 |
| External user connection | UDP | DMZ / Internal network | 1024–65535 | VDA network | 55000–55250 |
| External user connection | UDP | VDA network | 55000–55250 | Client's public IP | 1024–65535 |

Note:

Both the VDA and Workspace app attempt to send STUN requests to the following servers in the same order:

- stunserver.stunprotocol.org:3478
- employees.org:3478

- `stun.l.google.com:19302`

If you change the default port range for external user connections using the **HDX Direct port range** policy setting, the corresponding firewall rules must match your custom port range.

Configuration

HDX Direct is disabled by default. You can configure this feature using the **HDX Direct** setting in the Citrix policy.

- **HDX Direct**: To enable or disable a feature.
- **HDX Direct mode**: Determines if **HDX Direct** is available for internal clients only or for both internal and external clients.
- **HDX Direct port range**: Defines the port range that the VDA uses for connections from external clients.

Considerations

The following are considerations for using HDX Direct:

- HDX Direct for external users is only available with EDT (UDP) as the transport protocol. Therefore, **Adaptive Transport** must be enabled.
- If you are using **HDX Insight**, note that using **HDX Direct** prevents the HDX Insight data collection, as the session would no longer be proxied through NetScaler Gateway.
- When using non-persistent machines for your virtual apps and desktops, Citrix recommends enabling **HDX Direct** on the session hosts instead of in the master/template image so that each machine generates its own certificates.
- Using your own certificates with HDX Direct is not currently supported.

How it works

HDX Direct allows clients to establish a direct connection to the session host when direct communication is available. When direct connections are made using HDX Direct, self-signed certificates are used to secure the direct connection with network level-encryption (TLS/DTLS).

Internal users

The following diagram depicts the overview of the HDX Direct connection process of internal users.

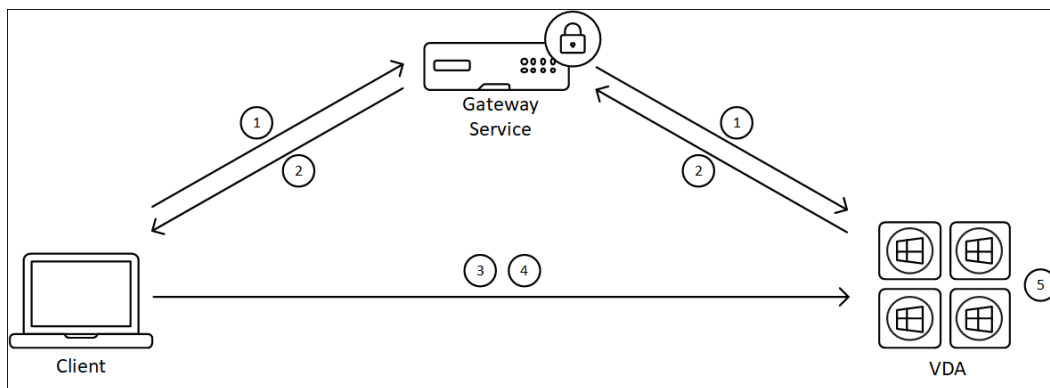

1. The client establishes an HDX session through the Gateway Service.
2. Upon a successful connection, the VDA sends to the client the VDA machine's FQDN, a list of its IP addresses, and the VDA machine's certificate via the HDX connection.
3. The client probes the IP addresses to see if it can reach the VDA directly.
4. If the client can reach the VDA directly with any of the IP addresses shared, the client establishes a direct connection with the VDA, secured with (D)TLS using a certificate that matches the one exchanged in step (2).
5. Once the direct connection is successfully established, the session is transferred to the new connection, and the connection to the Gateway Service is terminated.

Note:

After establishing the connection in step 2, above, the session is active. The subsequent steps do not delay or interfere with the user's ability to use the virtual application or desktop. If any of the subsequent steps fail, the connection through the Gateway is maintained without interrupting the user's session.

External users

The following diagram depicts the overview of the HDX Direct connection process for external users:

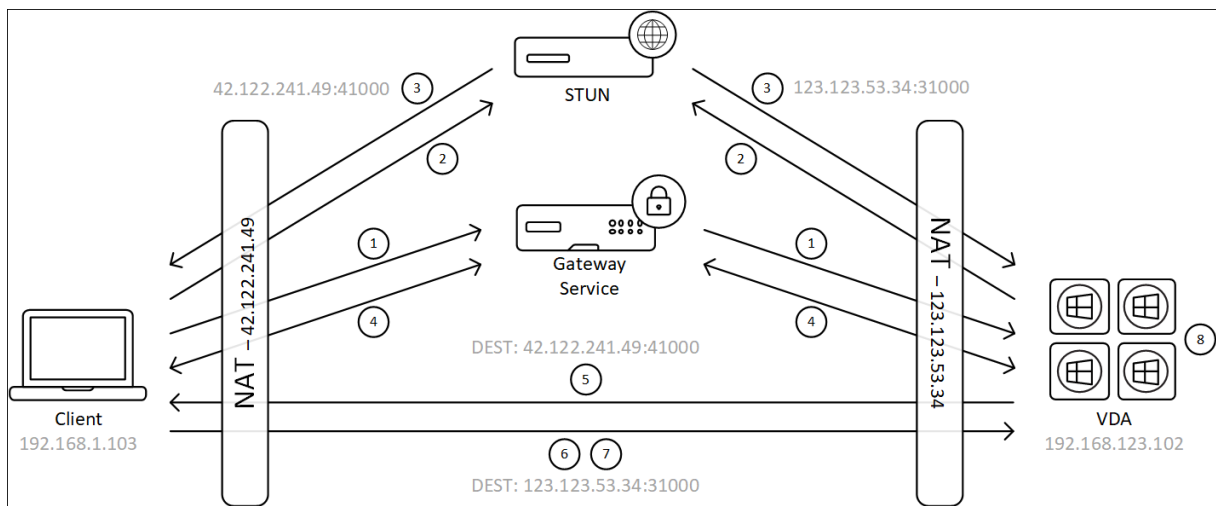

1. The client establishes an HDX session through the Gateway Service.
2. Upon a successful connection, both the client and the VDA send a STUN request to discover their public IP addresses and ports.
3. The STUN server responds to the client and VDA with their corresponding public IP addresses and ports.
4. Through the HDX connection, the client and the VDA exchange their public IP addresses and UDP ports, and the VDA sends its certificate to the client.
5. The VDA sends UDP packets to the client's public IP address and UDP port. The client sends UDP packets to the VDA's public IP address and UDP port.
6. Upon receipt of a message from the VDA, the client responds with a secure connection request.
7. During the DTLS handshake, the client verifies that the certificate matches the certificate exchanged in step (4). After validation, the client sends its authorization token. A secure direct connection is now established.
8. Once the direct connection is successfully established, the session is transferred to the new connection, and the connection to the Gateway Service is terminated.

Note:

After establishing the connection in step 2, above, the session is active. The subsequent steps do not delay or interfere with the user's ability to use the virtual application or desktop. If any of the subsequent steps fail, the connection through the Gateway is maintained without interrupting the user's session.

Certificate management

Session host

The following two services on the VDA machine handle certificate creation and management, both of which are set to run automatically at machine startup:

- Citrix ClxMtp Service: Responsible for CA certificate key generation and rotation.
- Citrix Certificate Manager Service: Responsible for generating and managing the self-signed root CA certificate and the machine certificates.

The following steps depict the certificate management process:

1. The services start at machine startup.
2. [Citrix ClxMtp Service](#) creates keys if none has been created already.
3. Citrix Certificate Manager Service checks if **HDX Direct** is enabled. If not, the service stops itself.
4. If **HDX Direct** is enabled, the Citrix Certificate Manager Service checks if a self-signed root CA certificate exists. If not, a self-signed root certificate is created.
5. Once a root CA certificate is available, the Citrix Certificate Manager Service checks if a self-signed machine certificate exists. If not, the service generates keys and creates a new certificate using the machine's FQDN.
6. If there is an existing machine certificate created by the Citrix Certificate Manager Service and the subject name does not match the machine's FQDN, a new certificate is generated.

Note:

The Citrix Certificate Manager Service generates RSA certificates that leverage 2048-bit keys.

Client device

To successfully establish a secure **HDX Direct** connection, the client must trust the certificates used to secure the session. To facilitate this, the client receives the CA certificate for the session through the ICA file (supplied by Workspace), so it is not necessary to distribute CA certificates to the client devices' certificate stores.

NAT Compatibility

December 19, 2023

To establish a direct connection between an external user device and the session host, HDX Direct leverages hole punching for NAT traversal and STUN to facilitate the exchange of the public IP address and port mappings for the client device and session host. This is similar to how VoIP, unified communications, and P2P solutions work.

As long as firewalls and other network components are configured to allow the UDP traffic for the STUN requests and the HDX sessions, HDX Direct for external users is expected to work. However, there are certain scenarios where the NAT types of the user and session host networks lead to an incompatible combination, thus causing HDX Direct to fail.

Validations

You can validate the NAT type on the client and the session host by using STUNMAN's STUN client utility:

1. Download the appropriate package for the target platform from stunprotocol.org, and extract the contents.
2. Open a terminal prompt and navigate to the directory where the contents were extracted.
3. Run the following command:

```
.\stunclient.exe stunserver.stunprotocol.org --mode behavior
```
4. Take note of the output.

If the binding and behavior tests are successful, both **binding test** and **behavior test** report the success and a NAT behavior is specified:

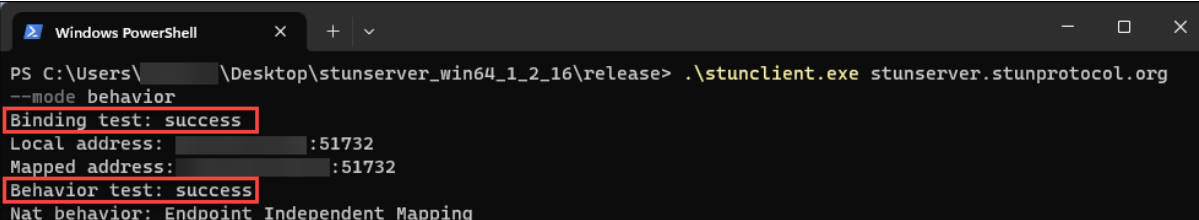

```
Windows PowerShell
PS C:\Users\... \Desktop\stunserver_win64_1_2_16\release> .\stunclient.exe stunserver.stunprotocol.org
--mode behavior
Binding test: success
Local address: ...:51732
Mapped address: ...:51732
Behavior test: success
Nat behavior: Endpoint Independent Mapping
```

If the tests fail, both **binding test** and **behavior test** report the failure.

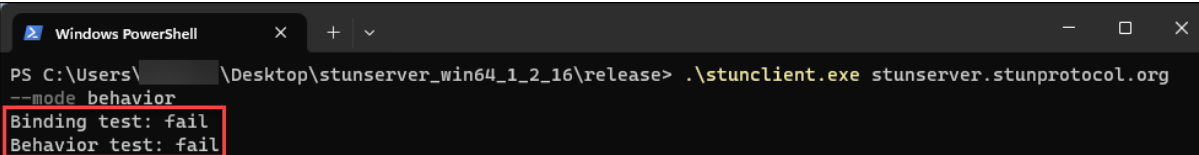

```
Windows PowerShell
PS C:\Users\... \Desktop\stunserver_win64_1_2_16\release> .\stunclient.exe stunserver.stunprotocol.org
--mode behavior
Binding test: fail
Behavior test: fail
```

See the following table to determine if HDX Direct for external users is expected to work based on the test results of both the client and session host:

| Client device | Session host | Expected to work? |
|------------------------------|------------------------------|-------------------|
| Endpoint Independent Mapping | Endpoint Independent Mapping | Yes |
| Endpoint Independent Mapping | Endpoint Dependent Mapping | Yes |
| Endpoint Dependent Mapping | Endpoint Independent Mapping | Yes |
| Endpoint Dependent Mapping | Endpoint Dependent Mapping | No |
| fail | Any NAT type | No |
| Any NAT type | fail | No |
| fail | fail | No |

Troubleshooting

December 20, 2023

To confirm that **HDX Direct** successfully established a direct connection, you can use the `CtxSession.exe` utility on the VDA machine.

To use the `CtxSession.exe` utility, launch a Command Prompt or PowerShell within the session and run `ctxsession.exe -v`. If the **HDX Direct** connection is successfully established, **HDX Direct Status** is `Connected`.

```
PS C:\Users\ > ctxsession -v
Session Id 1:
Transport Protocols: UDP -> DTLS -> CGP -> ICA
  Local Address: :55000
  Remote Address: :60410
  Client Address: :63274
Security Protocol: DTLS 1.2
Security Cipher: 256 bit AES
Cipher Strength: 256 bits
ICA Encryption: Transport Only
Rendezvous Version: None
HDX Direct State: Connected - External
Reducer Version: 4.0

EDT Reliable Statistics:
  Bandwidth 301.904 Mbps, RTT 57.690 ms, EDT MTU: 1480

EDT Unreliable Statistics:
  Bandwidth 7.544 Kbps, RTT 1 us, EDT MTU: 1480

EDT Reliable Basic FEC Statistics:
  Bandwidth 92.090 Mbps, RTT 35.164 ms, EDT MTU: 1480

ICA Statistics:
  SentBandwidth (bps) = 0
  HDX Latency = 63
  IcaBufferLength = 1436
```

You can also look at the session host's event logs for information on whether the HDX Direct connection was established successfully or failed. See the **Event Logs** section for details.

Note:

Depending on the environment and the number of IP addresses available to the session hosts, it can take up to 5 minutes for the HDX Direct connection to be established.

When HDX Direct fails to establish a direct connection

If HDX Direct is failing to establish a direct connection, review the following steps:

1. Ensure that the VDA version and Workspace app version in use support the feature per the system requirements.
2. Confirm that you have a policy applied to the VDA that enables HDX Direct and that there are no other policies with higher priority disabling the feature.
3. Confirm that you have a policy applied to the VDA that sets the desired HDX Direct mode and that there are no other policies with higher priority overwriting the configuration.
4. Ensure that the Citrix ClxMtp Service is running on the session host.
5. Ensure that the Citrix Certificate Manager Service is running on the session host. If it's not running, try to start it manually. The service automatically stops if HDX Direct is disabled.

6. Check if the session host has its self-signed Root CA certificate:
 - a) Issued to: `CA-<hostname>` (For example, CA-FTLW11-001)
 - b) Issued by: `CA-<hostname>` (For example, CA-FTLW11-001)
 - c) Issuer details: The organization is Citrix Systems, Inc.
7. Check if the session host has its self-signed server certificate:
 - a) Issued to: `<host FQDN>` (For example, FTLW11-001.ctxlab.net)
 - b) Issued by: `CA-<hostname>` (For example, CA-FTLW11-001)
 - c) Issuer details: The organization is Citrix Systems, Inc.
8. If the certificates are missing, contact Citrix Tech Support.
9. If the certificates are present:
 - a) Stop the Citrix Certificate Manager Service on the session host.
 - b) Delete both the self-signed Root CA certificate and the self-signed server certificate.
 - c) Start the Citrix Certificate Manager Service on the session host. The service creates new certificates once it starts.
10. For internal users:
 - a) Ensure the session host's firewall is not blocking inbound traffic on UDP 443 or TCP 443, for HDX over EDT and HDX over TCP, respectively.
 - b) Ensure that your network firewall is not blocking traffic on UDP 443 and TCP 443 between your clients' network and session hosts' network.
11. For external users:
 - a) Check the NAT type for the client and the session host, and ensure that the combination is expected to work. See the NAT Compatibility section for details.
 - b) If the NAT test fails on either the client or the session host:
 - i. If there is a firewall running on the system, ensure it is not blocking outbound traffic on UDP 3478.
 - ii. Ensure that your network firewalls are not blocking outbound traffic on UDP 3478.
 - iii. Ensure the firewalls are not blocking the STUN server's response.
 - c) Ensure that your network firewalls have the appropriate rules configured to allow all necessary traffic. See the [Network Requirements](#) section for details.
 - d) If you change the default port range using the HDX Direct port range policy setting, ensure that your firewall rules are set for the custom port range.

Event logs

The following events are logged in the VDA machine's event log:

| Log | ID | Source | Level | Description |
|---|----|------------|-------------|---|
| Applications and Services Logs > Citrix-HostCore-HDX Direct/Operational | 1 | HDX Direct | Information | HDX Direct connection for internal user <username> established. |
| Applications and Services Logs > Citrix-HostCore-HDX Direct/Operational | 2 | HDX Direct | Information | HDX Direct connection for external user <username> established. |
| Applications and Services Logs > Citrix-HostCore-HDX Direct/Operational | 3 | HDX Direct | Information | HDX Direct connection for user <username> failed. |

Known issues

HDX Direct might stop working after performing an in-place upgrade of the VDA on a machine that already has **HDX Direct** enabled.

To resolve the issue, complete the following steps:

1. Stop the Citrix Certificate Manager Service on the session host.
2. Delete the self-signed Root CA certificate and the self-signed server certificate.
3. Open the registry.
4. Delete the `HKLM\Software\Citrix\HDX-Direct` key.
5. Go to `HKLM\SYSTEM\CurrentControlSet\Control\TerminalServer\Wds\icawd`.
6. Set the **SSLEnabled** value to 0.
7. Delete the contents of the **SSLThumbprint** value.
8. Start the **Citrix Certificate Manager Service**.

Virtual channel allow list

March 1, 2024

The virtual channel allow list is a feature that allows you to control which non-Citrix virtual channels are allowed in your environment. By default, the virtual channel allow list feature is enabled. As a result, only Citrix virtual channels are allowed to open in Citrix Virtual Apps and Desktops sessions. If there is a need to use custom virtual channels, whether homegrown or from a third party, these need to be explicitly added to the allow list.

Configuration

The virtual channel allow list is enabled by default. You can configure this feature using the following settings in the Citrix policy:

- **Virtual channel allow list:** to enable or disable the feature and to add virtual channels to the list.
- **Virtual channel allow list log throttling:** sets the throttling period for the virtual channel allow list event logging.
- **Virtual channel allow list logging:** sets the logging level for the virtual channel allow list.

Adding virtual channels to the allow list

To add a virtual channel to the allow list, you need the following information:

1. The virtual channel name as defined in the code, which can be up to seven characters long. For example, `CTXCV1`.
2. The paths to the processes that open the virtual channel on the VDA machine. For example, `C:\Program Files\Application\run.exe`.

Once you have the required information, you must add the virtual channel to the allow list using the [Virtual channel allow list policy setting](#). To add a virtual channel to the list, enter the virtual channel name followed by a comma, and then the path to the process that accesses the virtual channel. If there are multiple processes, you can add these processes by separating each process with commas.

For single processes

Using the previous examples, add the following entry to the list:

```
CTXCV1,C:\Program Files\Application\run.exe
```

For multiple processes

If there are multiple processes, add the following entry to the list:

```
CTXVC1,C:\Program Files\Application\run.exe,C:\Program Files\Application\run2.exe
```

Using wildcards

The use of wildcards (*) is supported. You can use wildcards when the names of directories or executables change based on the version of the application, or if the third-party component is installed in the users' profiles.

You can use wildcards in the following scenarios:

- To replace the full directory name.
For example: `C:\Program Files\Application*\run1.exe`
- To replace part of the directory name.
For example: `C:\Program Files\Application\v*\run1.exe`
- To replace the executable's name.
For example: `C:\Program Files\Application\v1.2*.exe`
- To replace part of the executable's name.
For example: `C:\Program Files\Application\v1.2\run*.exe`

The following restrictions apply:

- The wildcard can only be used to replace a single directory. For example, if the executable is located in `C:\Program Files\Application\v1.2\run1.exe`
 - Allowed: `C:\Program Files\Application*\run1.exe`
 - Not allowed: `C:\Program Files*\run1.exe`
- Entries must contain the file name extension.
 - Allowed: `C:\Program Files\Application\v1.2*.exe`
 - Not allowed: `C:\Program Files\Application\v1.2*`
- All paths must be local.

Note:

- Network paths are not allowed.
- Wildcard support is available from Citrix Virtual Apps and Desktops 2206.
- Wildcard support is available in Citrix Virtual Apps and Desktops 2203 LTSR from CU2.

Using system environment variables

You can use system environment variables to simplify the definition of the trusted processes in your allow list. You can use any of the out-of-box variables, such as `%programfiles%`, `%programfiles(x86)%`, `%systemdrive%`, and `%systemroot%`.

You can also use custom environment variables as long as they are defined at the system level.

The following examples depict out-of-box environment variables:

- `%programfiles%\Application\v1.2\run.exe`
- `%programfiles%\Application*\run.exe`
- `%programfiles(x86)%\Application\v1.*\run.exe`

The following example depicts a custom system environment variable:

- Custom variable name: `app`
- Custom variable value: `%programfiles%\Application\`
- Allow list entry: `CTXCVC1,%app%\run.exe`

Note:

User environment variables are not supported.

Environment variable support is available from Citrix Virtual Apps and Desktops version 2209.

Obtain virtual channel names and processes

The easiest way to obtain the name of the virtual channel and the process that opens it on the VDA machine is to get the information from the developer or a third-party vendor that provided the virtual channel.

Alternatively, you can obtain information by applying the feature's logs and following these steps:

1. Once the client and server components of the custom virtual channel are in place, launch a virtual application or virtual desktop.
2. In the VDA machine's System event log, look for the custom virtual channel's name and the process that tried to open it. For more information on available events, see [Event logs](#).
3. Log out from the session.
4. Add an entry in the virtual channel allow list policy settings for the identified virtual channel and process.
5. Restart the machine.
6. Once the VDA is registered, run the virtual application or virtual desktop to validate that the custom virtual channels open successfully.

Considerations for Citrix virtual channels

All built-in Citrix virtual channels are trusted and allowed to open without further configuration. However, the following two features require explicit entries in the allow list because of external dependencies:

- Multimedia Redirection
- HDX RealTime Optimization Pack for Skype for Business

Multimedia Redirection

If you use a media player other than Windows Media Player as your system media player, you need to add it to the allow list as a trusted process. The following information is required for the allow list entry:

- Virtual channel name: `CTXMM`
- Process: Path to the media player used in your VDA machine. For example, `C:\Program Files (x86)\Windows Media Player\wmpplayer.exe`.
- Allow list entry: `CTXMM,C:\Program Files (x86)\Windows Media Player\wmpplayer.exe`

HDX RealTime Optimization Pack for Skype for Business

The following information is required for the allow list entry:

- Virtual channel name: `CTXRMEP`
- Process: Path to the Skype for Business executable in your VDA machine, which can vary based on the version of Skype for Business or if you used a custom installation path. For example, `C:\Program Files\Microsoft Office\root\Office16\lync.exe`.
- Allow list entry: `CTXRMEP,C:\Program Files\Microsoft Office\root\Office16\lync.exe`

Troubleshooting

March 1, 2024

If your custom virtual channel fails to open, review the following steps:

1. Ensure you are using the correct VDA version.

2. Confirm that you have a policy applied to the VDA with the custom virtual channel in the virtual channel allow list and that there are no other policies with higher priority overwriting this configuration.
3. Check the event log in the VDA and confirm that the virtual channel name reported matches the one defined in the allow list.
 - a) If you have multiple processes, ensure these are defined properly as described in [Adding virtual channels to the allow list](#).
 - b) If you are using wildcards in the defined process path, ensure you are adhering to the guidelines for [Using wildcards](#).
 - c) If you are using environment variables in the defined process path, ensure you are adhering to the guidelines in [Using system environment variables](#).

Event logs

The following events are logged in the VDA machine's event log.

Single-session VDA

The following events are logged in the single-session VDA machine's event log:

| Log Name | Id | Source | Level | Description |
|----------|------|--------|-------------|---|
| System | 2001 | Picadd | Information | Custom virtual channel <vcName> has been opened by process <processName> |
| System | 2002 | Picadd | Warning | Custom virtual channel <vcName> cannot be opened by process <processName> |

| Log Name | Id | Source | Level | Description |
|----------|------|--------|-------------|--|
| System | 2003 | Picadd | Information | <username>
opened custom
virtual channel
<vcName> |
| System | 2004 | Picadd | Warning | <username>
tried to open
custom virtual
channel
<vcName> |
| System | 2005 | Picadd | Error | Path given in
policy <
pathInPolicy
> cannot resolve
to process path |
| System | 2007 | Picadd | Information | Loaded process
path is <
processPath> |
| System | 2008 | Picadd | Error | Environment
variable
<varName> in
VC policy path is
not found |

Multi-session VDA

The following events are logged in the multi-session VDA machine's event log:

| Log Name | Id | Source | Level | Description |
|----------|----|--------|-------------|--|
| System | 13 | Rpm | Information | Custom virtual
channel
<vcName> has
been opened by
process <
processName> |

| Log Name | Id | Source | Level | Description |
|----------|----|--------|-------------|---|
| System | 14 | Rpm | Warning | Custom virtual channel <vcName> cannot be opened by process <processName> |
| System | 15 | Rpm | Information | <username> opened custom virtual channel <vcName> |
| System | 16 | Rpm | Warning | <username> tried to open custom virtual channel <vcName> |
| System | 17 | Rpm | Error | Path given in policy <pathInPolicy> cannot resolve to process path |
| System | 18 | Rpm | Information | Loaded process path is <processPath> |
| System | 19 | Rpm | Error | Environment variable <varName> in VC policy path is not found |

Known third-party virtual channels

March 1, 2024

The following are known third-party solutions that use custom Citrix virtual channels. This list does not include every solution that uses a custom Citrix virtual channel.

- Cerner
- [ControlUp](#)
- [Cisco WebEx Teams](#)
- Cisco WebEx Meetings Virtual Desktop Software
- [deviceTrust](#)
- [Epic Warp Drive](#)
- [Epic Slingshot](#)
- Imprivata OneSign
- Midmark IQPath Client Extensions
- Nuance PowerMic Client Extensions
- Nuance Dragon Medical Network Edition 360 vSync
- [Zoom Meetings for VDI](#)
- Ultima IA-Connect

To obtain details for adding the associated virtual channels to the allow list, reach out to the solutions' vendors. Alternatively, follow the steps outlined in the [Obtaining virtual channel names and processes](#) section.

Devices

April 4, 2024

HDX provides a high-definition user experience on any device, at any location. The articles in the Devices section describe these devices:

- [Scanning](#)
- [Generic USB device](#)
- [Client Drive Mapping](#)
- [Mobile and touch screen devices](#)
- [Serial devices](#)
- [Specialty keyboards](#)
- [Webcams](#)

Optimized vs. generic USB device

An optimized USB device is one for which Citrix Workspace app has specific support. For example, the ability to redirect webcams using the HDX Multimedia virtual channel. A generic device is a USB

device for which there is no specific support in Citrix Workspace app.

By default, generic USB redirection can't redirect USB devices with optimized virtual channel support unless put into Generic mode.

In general, you get better performance for USB devices in Optimized mode than in Generic mode. However, there are cases where a USB device doesn't have full functionality in Optimized mode. It might be necessary to switch to Generic mode to gain full access to its features.

With USB mass storage devices, you can use either client drive mapping or generic USB redirection, or both, controlled by Citrix policies. The main differences are:

If both generic USB redirection and the client drive mapping policies are enabled and a mass storage device is inserted either before or after a session starts, it's redirected using client drive mapping.

When these conditions are true, the mass storage device is redirected using generic USB redirection:

- Both generic USB redirection and the client drive mapping policies are enabled.
- A device is configured for automatic redirection.
- A mass storage device is inserted either before or after a session starts.

For more information, see <http://support.citrix.com/article/CTX123015>.

| Feature | Client drive mapping | Generic USB redirection |
|-------------------------------|--|------------------------------|
| Enabled by default | Yes | No |
| Read-only access configurable | Yes | No |
| Encrypted device access | Yes, if encryption is unlocked before the device is accessed on the virtual session. | Citrix Virtual Desktops only |

Scanning

April 10, 2024

Scanner is a device that optically scans images, printed text, handwriting or an object and converts it to a digital image.

If you're using a scanner and your computer is running windows, there's a good chance you're using the WIA scanner driver. This driver is responsible for communicating between your computer and scanner.

- **Windows Image Acquisition** (WIA) is Microsoft's driver model and application programming interface (API) that enables software to communicate with imaging hardware like scanners.
- **TWAIN** (Windows and Mac) is another protocol which is a scanning protocol that connects scanners and applications together by providing standard interface. TWAIN allows applications to acquire images from TWAIN compliant devices (scanners, digital cameras, etc.).

TWAIN Redirection

April 11, 2024

Introduction

TWAIN is a scanning protocol used to link image software to scanners or digital cameras.

How TWAIN works

- Scan your documents using any of the 32-bit applications in your Citrix session.

Note:

Use a locally attached TWAIN-compliant scanner to scan the documents.

- The Citrix scanning module redirects the TWAIN request to the client's scanner.
- Once the scan is complete, the session host is notified.

Requirements

Citrix Control Plane

- Citrix Virtual Apps and Desktops 1912 or later
- Citrix DaaS

Session Host

- Operating system
 - Windows 10 1809 or later
 - Windows 11

- Windows Server 2022 or later
- VDA
 - Version 1912 or later
- Application
 - 32-bit application

Client Device

- Operating system
 - Windows 10 1809 or later
 - Windows 11
- Workspace app
 - Windows: version 1912 or later
- Scanner
 - TWAIN-compliant scanner

Configuration

- Install TWAIN drivers on the client endpoint.
- Set up devices or applications to select the required scanning protocol if they support both TWAIN and WIA.
- Attach the scanner to the client endpoint locally (through USB).
- Redirect TWAIN devices to the session via USB redirection if needed.

Note:

TWAIN devices don't work well with USB redirection leading to poor scan quality.

Policy Settings

Policy settings to set up TWAIN redirection and improve scanning.

- **Client TWAIN device redirection:** to enable or disable TWAIN redirection.

Note:

By default, TWAIN redirection is enabled.

- **TWAIN compression level:** to set compression levels for images from client to host.

For more details, see [TWAIN devices policy settings](#).

Troubleshooting

Try out TWAIN with the public test app **Twacker** [available](#).

Follow the steps to validate TWAIN within a published desktop session:

1. Install **Twacker** on the VDA.
2. Launch **Twacker** (32-bit version).
3. Click **File > Select Source** and select your scanner from the list.
4. Click **File > Acquire**.
5. Click the **Scan button** to test your scanner.

If **Twacker** can scan successfully, it confirms that the XenApp setup is:

- Configured for USB redirection
- Using TWAIN devices
- Meeting all local client device requirements

If you still have scanning issues within a particular application, then it's likely to be a software issue.

WIA devices

April 5, 2024

Requirements

- The scanner must be WIA compliant.
- Install the WIA drivers on the local device. They are not required on the server.
- Attach the scanner locally (for example, through USB).
- Ensure that the scanner is using the local Windows Image Acquisition service and not the TWAIN driver.
- Ensure that there is no policy applied to the user account that is used for the test, and which is limiting the bandwidth within the ICA session. For example, client USB redirection bandwidth limit.

Windows Image Acquisition application allow list

An allow list lets you control which applications on the VDA can access the Windows Image Acquisition scanner redirection. The Registry Editor uses input from the allow list setting on each VDA that contains Windows Image Acquisition. By default, no applications have access to Windows Image Acquisition.

To adjust Windows Image Acquisition for applications on the VDA, see the [Windows Image Acquisition application allow list](#) setting in the list of features managed through the registry.

For information about policy settings, see [WIA devices policy settings](#).

Generic USB devices

April 4, 2024

Introduction

The generic USB redirection feature allows redirection of USB devices from client machines to HDX sessions giving end users the ability to interact with a wide selection of generic USB devices in their HDX session. This is helpful in scenarios where users need to use speciality devices that don't have optimized support or where it is unsuitable.

Note: USB Devices not optimized for virtual channel support will fall back to the Generic USB virtual channel using raw USB redirection.

How does it work?

Generic USB redirection works at a low level and redirects USB request and response messages between client machines and XenDesktop virtual desktop.

It avoids the requirement for compatible device drivers on the client machine and the driver is expected to be supported on the virtual desktop only. USB redirection policy rules follow a certain order of precedence that allow client side policies and default rules to be honored after DDC policy rules have been evaluated and enforced. This allows Citrix admins to prevent any unauthorized/spoofed devices from being redirected inside a session.

Additionally, event logging of unauthorized devices attempting to access the remote session can be audited and flagged and admins can take additional action to prevent data exfiltration.

When a user plugs in a USB device, the session host checks it against each policy rule consecutively until a match is found. The first match for any device is considered definitive.

- If the first match is an Allow rule, the device is redirected to the virtual desktop.
- If the first match is a Deny rule, the device is not redirected to the session, and only available for use in the local user device. If no match is found, default rules are used.



Configuration

April 16, 2024

USB redirection is disabled by default. You can configure generic USB redirection using the following settings in Citrix policy:

- **Client USB device redirection:** to enable or disable USB redirection
- **Client USB device redirection rules:** to specify specific device action i.e. to allow or deny access to a particular device
- **Client USB device redirection rules (Version 2):** to specify rules for filtering, splitting and auto-connecting USB devices
- **Client USB device optimization rules:** to disable optimization or change the optimization mode

- **Allow existing USB devices to be automatically connected:** to allow or prevent automatic connection of existing USB devices that are connected to a client endpoint at the start of an HDX session
- **Allow newly arrived USB devices to be automatically detected:** to allow or prevent automatic connection of USB devices that are connected to a client endpoint during an HDX session

See, [USB Policy Settings](#) for more details.

How to configure USB redirection

By default, USB redirection configuration is disabled. To use it, USB redirection policy and specific redirection rules must be enabled and configured on the DDC.

Note:

If you are using any components older than version 2212 or you are using Workspace App for Linux/Mac, see [Legacy USB Redirection Configuration](#) for details on how to configure USB redirection.

Enabling Generic USB Redirection

1. Open **Citrix Web Studio policies** and click on the **Policies** tab.
2. Click on **Create Policy** and expand the **ICA > USB Devices policies**.
3. Edit the **Client USB device redirection policy**.
4. Select **Allowed** and click **Save**.

Creating USB Redirection Policy Rules

When the user tries to redirect a USB device to Virtual Desktop, it is checked against each USB policy rule in turn until a match is found. The first match for any devices is considered final. If the first match is an **Allow** rule, the matched device is allowed to be redirected to the virtual desktop. If the first match is a **Deny** rule, the matched device is only available in the local desktop. If no match is found, default rules are used.

Device Rules As with regular USB devices, device rules set in the policy or client Citrix Workspace app configuration on the end point select the devices for forwarding. Citrix Workspace app uses these rules to decide which USB devices to allow or prevent from forwarding to the remote session.

Each rule consists of an action keyword (**Allow, Connect, or Deny**), a colon (:), and zero or more filter parameters that match actual devices at the endpoints USB subsystem. These filter parameters correspond to the USB device descriptor metadata used by every USB device to identify itself.

Device rules are clear text with each rule on a single line and an optional comment after a # character. Rules are matched top down (descending priority order). The first rule that matches the device or child interface is applied. Subsequent rules that select the same device or interface are ignored.

Example: ALLOW VID=1050 PID=0421 #Device1

Example: CONNECT VID=xxxx PID=yyyy Class=03 #Device2

| Keyword | Description |
|---------|--|
| CONNECT | Use this keyword to allow devices to be redirected over the USB virtual channel as well as enable them to be auto-redirected during session launch and upon insertion. |
| ALLOW | Use this keyword to allow devices to be redirected over the USB virtual channel |
| DENY | Use this keyword to deny devices from being redirected over the USB virtual channel |

The screenshot shows the 'Select Settings' interface in Citrix. On the left, a navigation pane lists various settings categories, with 'USB Devices' selected under 'Graphics'. The main area displays a list of settings for 'Client USB device redirection rules (Version 2)'. The settings include checkboxes for 'Allow existing USB devices to be automatically connected', 'Allow newly arrived USB devices to be automatically connected', and 'Client USB device redirection'. The 'Client USB device redirection' setting is currently set to 'Prohibited'. Below the settings list, there is a detailed description of the device rules, including a list of example rules for various Microsoft Surface devices.

Setting the policy on the DDC:

1. Open **Citrix Web Studio policies** and click on the **Policies** tab.
2. Click on **Create Policy** and expand the **ICA > USB Devices policies**.
3. Edit the **Client USB device redirection rules (Version 2)**.
4. Set the value based on the examples provided in the description for each usb device that needs to be redirected and click Save.

For Example: Allow: VID=056A PID=00A4 #STU-430

Deny: Class=08 subclass=05 # Mass Storage

Note:

If a Citrix admin checks **Use default value** and clicks on **Save**, the default rules can be found in the following registry in the VDA.

Caution!

Refer to the Disclaimer at the end of this article before using the Registry Editor.

HKLM\SOFTWARE\Wow6432Node\Citrix\PortICA\GenericUSB\DeviceRules

Note:

Policies can still be set on the client device using group policy device rules but that is no longer needed on newer versions of CVAD and CWA.

For legacy configuration of USB devices, see [Legacy USB Redirection Configuration](#).

Configure automatic redirection of USB devices (Optional)

USB devices are automatically redirected when USB support is enabled. Also, the USB user preference settings are set to automatically connect USB devices. It is not always best to redirect all USB devices. Users can explicitly redirect devices from the USB device list that are not automatically redirected. To prevent USB devices from being listed or redirected, use DeviceRules on either the client endpoint or the DDC policy.

This policy can be set either on the DDC, on the client using a GPO, using Citrix Workspace Preferences or the Connections tab under CDViewer. All of these methods are described below:

Setting the policy on the DDC:

There are two policies on the DDC that can be set to allow auto redirection of USB devices-

- Allow existing USB devices to be automatically connected
- Allow newly arrived USB devices to be automatically connected
 1. Open **Citrix Web Studio policies** and click on the **Policies** tab.
 2. Click on **Create Policy** and expand the **ICA > USB Devices policies**.
 3. Edit the setting **Allow** existing USB devices to be automatically connected.
 4. Clear the **Use default value** checkbox and select **Automatically redirect available USB devices** from the drop down menu and click **Save**.
 5. Edit the setting **Allow** newly arrived USB devices to be automatically connected.
 6. Clear the **Use default value** checkbox and select **Automatically redirect available USB devices** from the drop down menu and click **Save**.

Composite Devices and Device Splitting

April 16, 2024

A composite USB device is a single device that acts like multiple independent USB devices connected to a computer. It has a single USB connector but it can expose multiple interfaces to the computer

with each having its own set of functionalities. When a user plugs in a composite USB device, the host device checks for all functions (interfaces) against each policy rule. If the first match for any function(interface) is a Deny rule, the rule is considered definitive for the composite device and the device is denied. If the first match for a function (interface) is an Allow rule, the host device continues to match the rules against the next function (interface). The composite device is allowed if no function (interface) is denied by a policy rule. If definitive match for composite device is a Deny Rule, the device is available only to the local desktop otherwise the device is remoted to the virtual desktop. If no match is found, default rules are used.

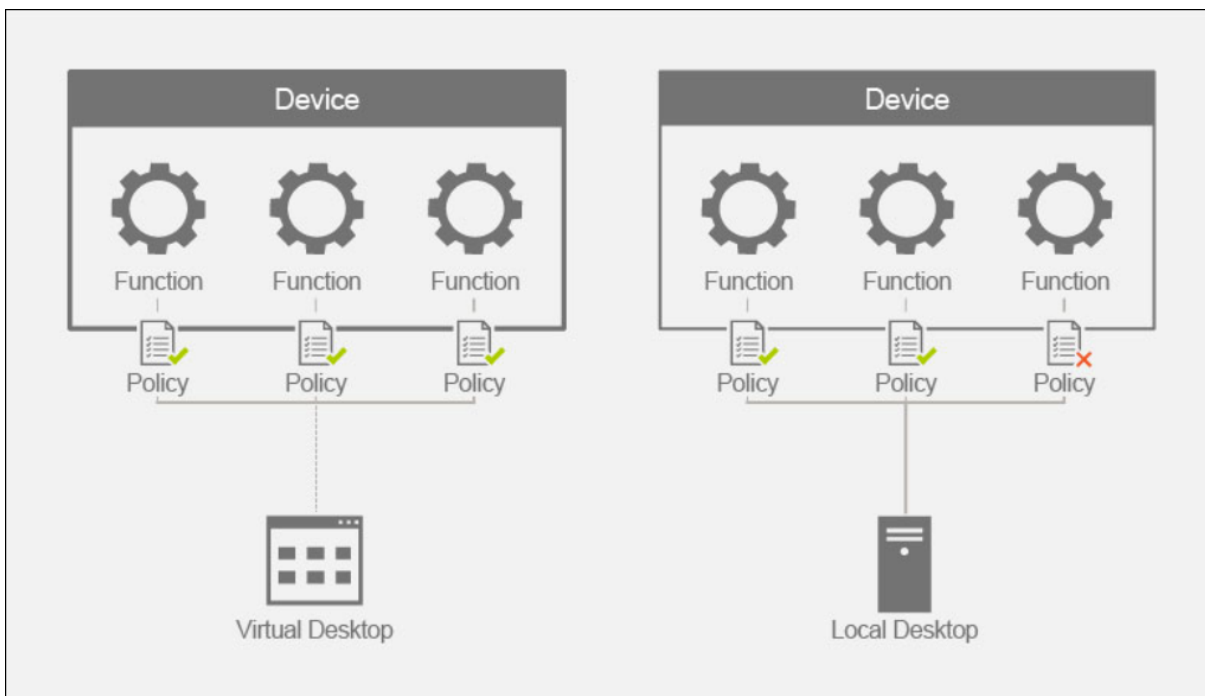

We can split the composite device using the appropriate rules in the Device redirection rules (Version 2) policy to allow only specific functionality of a composite device. For instance, we may want to use just the HID functions of a FIDO2 key but not the smartcard functionality. In that case, we would set the rules as illustrated below:

1. Connect: VID=1050 PID=0407 class=03 split=01 intf=00,01 #Yubikey series 5 allowed FIDO2 HID functions.
2. Deny: VID=1050 PID=0407 split=01 intf=02 # Yubikey series 5 smartcard function blocked.

Tip:

When creating new policy rules, refer to the [USB Class Codes](#), available on the USB web site.

Configuring a signature pad

1. Install the appropriate device driver on the VDA host.

2. Turn On the **Client USB device redirection policy** in **Citrix Web Studio**.
3. Edit the **Client USB device redirection rules** (Version 2) policy.
 - a) Set the **VID** and **PID** information for the signature pad that needs to be redirected and click **Save**. For example: **Connect:** VID=056A PID=00A4 #STU-430
4. Edit the policy **Client USB device optimization rules**.
 - a) Set the mode along with other device information. For example: Mode=00000004 VID=056A PID=00A4 class=03 #Input device operating in capture mode
5. Edit the policy **Allow existing USB devices to be automatically connected**.
6. Clear the **Use default value** checkbox and select **Automatically redirect available USB devices** from the drop down menu and click **Save**.
7. Edit the policy **Allow newly arrived USB devices to be automatically connected**.
8. Clear the **Use default value** checkbox and select **Automatically redirect available USB devices** from the drop down menu and click **Save**.

Once these policies are set in the Studio console, subsequent session launches will have the device getting automatically redirected and will not require any additional end user action.

Note:

Replace the VID and PID with the actual VID and PID of the device to be redirected.

Configuring Bloomberg keyboard using USB redirection

1. Turn On the **Client USB device redirection policy** in **Citrix Web Studio**.
2. Bloomberg 5 keyboards are set by default in the Client USB device redirection rules (Version 2) policy and no additional admin action is needed.
3. Edit the policy **Allow existing USB devices to be automatically connected**.
4. Clear the **Use default value** checkbox and select **Automatically redirect available USB devices** from the drop down menu and click **Save**.
5. Edit the policy **Allow newly arrived USB devices to be automatically connected**.
6. Clear the **Use default value** checkbox and select **Automatically redirect available USB devices** from the drop down menu and click **Save**.

Once these policies are set in the Studio console, Bloomberg keys will automatically be presented in subsequent HDX sessions and will not require any additional end user action.

Configuring a FIDO2 key using USB redirection

Citrix recommends using FIDO2 redirection for using FIDO2 keys in your HDX sessions. However, there might be situations in which you must redirect FIDO2 keys using USB redirection instead. These include scenarios where FIDO2 redirection is not available because the feature is not supported by the client, the VDA, or the operating system (e.g. Windows Server 2016).

There can also be situations in which the key has multiple modes enabled, but you only want to allow a subset of those in your HDX sessions. For example, you might want to allow FIDO2 and OTP, but block the smart card.

The following steps illustrate how you can configure a FIDO2 key using USB redirection (Yubikey vid=1050, pid=0407).

1. turn On the **Client USB device redirection policy** in **Citrix Web Studio**.
2. Edit the **Client USB device redirection rules** (Version 2) policy.
 - a) Set the **VID** and **PID** information as well as the split device configuration for the FIDO2 key to be redirected in the session and click **Save**.
 - b) **Connect:** VID=1050 PID=0407 class=03 split=01 intf=00,01 #Yubikey series 5 allowed FIDO2 HID functions.
 - c) **Deny:** VID=1050 PID=0407 split=01 intf=02 # Yubikey series 5 smartcard function blocked.
3. Edit the policy **Allow existing USB devices to be automatically connected**.
4. Clear the **Use default value** checkbox and select **Automatically redirect available USB devices** from the drop down menu and click **Save**.
5. Edit the policy **Allow newly arrived USB devices to be automatically connected**.
6. Clear the **Use default value** checkbox and select **Automatically redirect available USB devices** from the drop down menu and click **Save**.

Once these policies are set in the Studio console, FIDO2 keyboards will automatically be presented in subsequent HDX sessions and will not require any additional end user action.

Configuring a 3-d mouse using USB redirection

Today 3dConnexion space mouse drivers are only supported on workstation Oses (Win 10 and Win11). They do not work on server OS. The following are the steps to configure a SpaceMouse Enterprise on a workstation OS (vid=046D, pid=C016).

1. Install the latest [Windows driver](#) on the VDA host.
2. Turn On the **Client USB device redirection policy** in **Citrix Web Studio**.

3. Edit the **Client USB device redirection rules** (Version 2) policy.
 - a) Set the **VID** and **PID** information for the signature pad that needs to be redirected and click **Save**. For example: **Connect:** VID=046D PID=C016 #SpaceMouse Enterprise
4. Edit the policy **Client USB device optimization rules**.
 - a) Set the mode along with other device information. For example: Mode=00000004 VID=046D PID=C016 class=03 #Input device operating in capture mode
5. Edit the policy **Allow existing USB devices to be automatically connected**.
6. Clear the **Use default value** checkbox and select **Automatically redirect available USB devices** from the drop down menu and click **Save**.
7. Edit the policy **Allow newly arrived USB devices to be automatically connected**.
8. Clear the **Use default value** checkbox and select **Automatically redirect available USB devices** from the drop down menu and click **Save**.

Troubleshooting

April 15, 2024

The following steps should be followed to triage USB redirection related issues:

1. Validate system requirements are being met for USB redirection. This includes correct CVAD and CWA versions, supported devices and device drivers on the OS platform under consideration.
2. Ensure the configuration is appropriate based on the components' versions and platforms in use in your environment. See the note in Legacy USB Redirection Configuration for details on components that require [legacy configuration settings](#).
3. Validate that device is listed under devices that the client has enumerated.
 - a) Workspace Preferences toolbar: Look at the devices enumerated in the Devices tab of the Workspace app Preferences toolbar (Right click **CWA icon > Connection Center > Preferences**... Click on **Devices** tab).
 - b) `CtxUsbDiagnostics.exe` (Recommended): Run this tool in a command prompt window. The output gives you device specific information for a specific session. It will tell you if a device is being redirected or not. It will also tell you if a device rule set is causing the device to not be redirected. See, [Diagnostics Tool](#) for more information.
 - c) USBView or other 3rd party tools: Run a 3rd party tool like USBView in the endpoint / client machine to ensure that the device is detected at the endpoint.

4. If you see the device being enumerated:
 - a) If you see a Deny rule in the CtxUsbDiagnostics tool output for a particular device, check the policies configured in Studio and ensure that the rules are correctly set in Version 2 policy. If the deny rule doesn't appear in the studio policy, check the client side policy and finally the client side defaults in that order to find the matching deny rule.
 - b) If there is no deny rule in the CtxUsbDiagnostics output, then CWA will allow redirection of the device by checking / clicking the appropriate button in the devices tab of the Preferences window (Devices > Manage devices). A device once redirected will be available in the session. This can be verified by checking the device manager / USBView or similar application in the HDX session.

5. If you do not see the device being presented inside the session:
 - a) It is possible that the correct device driver is not installed correctly on the VDA host. Ensure that the latest versions of device drivers are correctly installed on the VDA host. Some device drivers are not supported on terminal server machines so ensure that is not the case with the device you are trying to redirect.
 - b) Ensure that the device is not being used on the client endpoint. Some devices require drivers to be installed on the client endpoint as well and this could prevent them from being redirected in the session.

6. Validate USB related rules are set correctly on the client endpoint:
 - a) CWA for Windows :
 - i. Validate that group policy on the client (add more detail and SS for this) is appropriately set and does not conflict with the rules set in Studio.
 - ii. Validate that default rules in the client's registry.

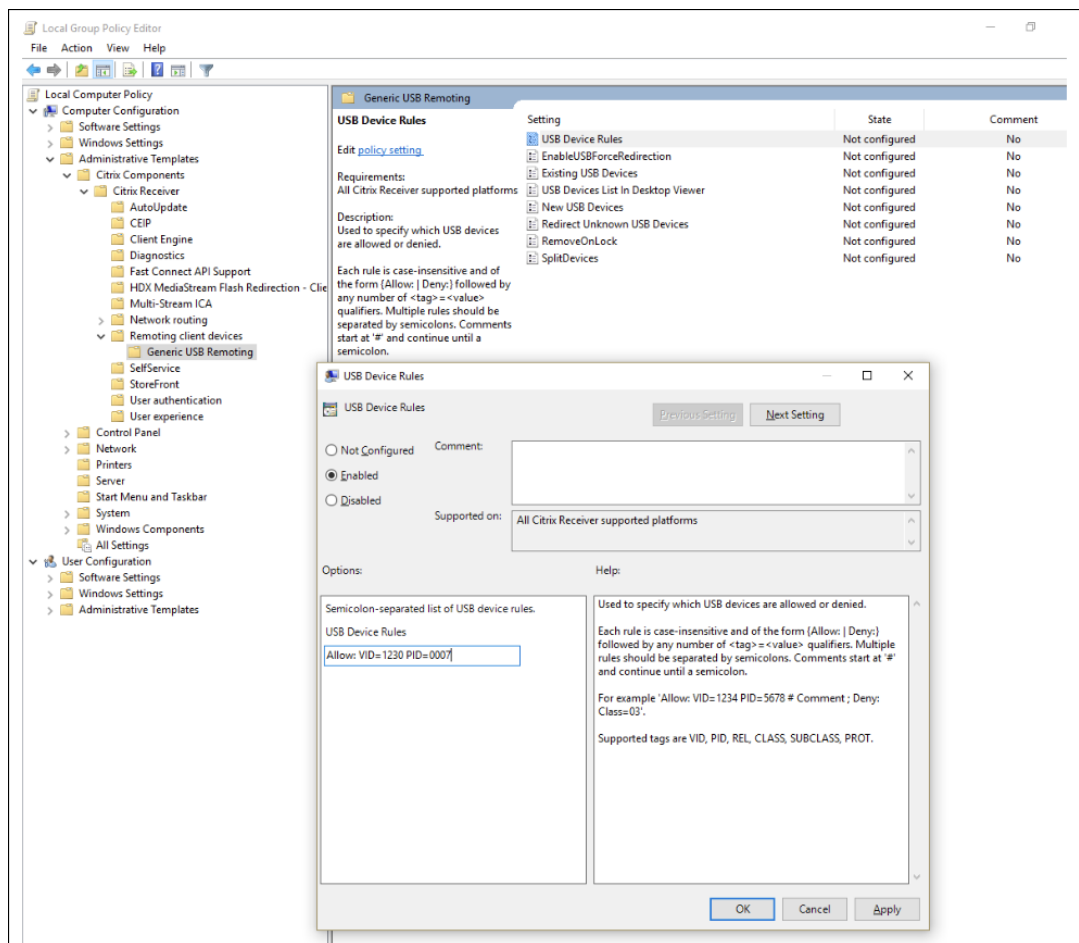

(HKLM\SOFTWARE\Wow6432Node\Citrix\PortICA\GenericUSB\DeviceRules) are appropriately set and not in conflict with the rules set in Studio and client group policy.

- b) CWA for Linux - To triage CWA for Linux issues, see [CWA for Linux](#)
- c) CWA for Mac - To triage CWA for Mac issues, see [CWA for Mac](#)

Note:

- On TSVDA, audio devices are blocked by default from using USB redirection. The recommended way to use those devices is using the optimized Audio VC.
- Sometimes, USB composite devices might not be split automatically even though a correct device redirection rule is set to split the device. This issue occurs because the device is in low power mode. In these instances, the child device that enters low power mode might not be present in the device list. You can use the following workarounds to overcome this issue:
 - Disconnect the session, insert the USB device, and reconnect to the session.

- Unplug the USB device and plug it back in. This action results in the device moving out of low power mode.
- Sometimes, USB battery saver settings may be enabled to optimize battery life. If the client endpoint goes to sleep, the USB device may get disconnected. In such a scenario, you might have to disconnect and reconnect the device in order to present the device again in the session.

Event Logs

Administrators can now monitor for unauthorized devices that users may attempt to redirect and can take the appropriate action. Here are some of the event messages that will be logged in the Event viewer on the VDA host for devices that are allowed to be redirected and for devices that are not.

| | |
|-----------------|---|
| Id | 1000 |
| Name | UsbEventAcceptDevice |
| Severity | Informational |
| Facility | System |
| Text | The Citrix USB Service allows the USB Device with Product ID: %2, Vendor ID: %3, and Device ID: %4 to be removed. |
| Comment | This message logs the device info of a device redirected in an HDX session |

| | |
|------------------|---|
| Id | 1001 |
| Name | UsbEventPolicyRejectsDeviceV1 |
| Severity | Warning |
| Facility | System |
| Text | The USB device with Product ID: 0x%2, Vendor ID: 0x%3, and Device ID: 0x%4 is not being redirected because the Citrix USB policy, "DENY: ...%5..." is in effect. If you wish to redirect the device, please set an allow rule that matches the device in the "Client USB device redirection rules" policy in Citrix Studio. |
| Comment | This message displays a message of the device not getting redirected if a DENY rule is being enforced by the legacy "Client USB device redirection rules" policy rule. |
| Arguments | |

| | |
|------------------|--|
| Id | 1002 |
| Name | UsbEventPolicyRejectsDeviceV2 |
| Severity | Warning |
| Facility | System |
| Text | The USB device with Product ID: 0x%2, Vendor ID: 0x%3, and Device ID: 0x%4 is not being redirected because the Citrix USB policy, "DENY: ...%5..." is in effect. If you wish to redirect the device, please set an allow rule that matches the device in the "Client USB device redirection rules (Version 2)" policy in Citrix Studio. |
| Comment | This message displays a message of the device not getting redirected if a DENY rule is being enforced by the "Client USB device redirection rules (Version 2)" policy rule. For instance, if the studio policy rule allows an approved set of devices and denies all other devices and an end user tries to create a new rule on the client endpoint via group policy, this event will get logged. This message would be indicative of an unauthorized device redirection attempt. |
| Arguments | |

USB Diagnostics Tool

April 15, 2024

[CtxUsbDiagnostics.exe](#) is a command-line tool on the VDA to help Citrix admins diagnose and resolve USB device redirection issues experienced on the client in an expedited manner. This utility tool collects vital information required to resolve configuration issues associated with USB devices attached to the client that are failing to redirect inside an HDX session.

Requirements

Session host

- Operating system

- Windows 10 1809 or later
- Windows 11 21H2 or later
- Windows Server 2016 or later
- VDA
 - Windows: Citrix Virtual Apps and Desktops Version 2311 or later

Client device

- Operating system
 - Windows 10 1809 or later
- Workspace App
 - Windows: version 2311 or later

What does the tool do?

The tool currently provides:

- SessionID
- VDA device policies (device rules set in Studio)
- Client devices and client device policies (device rules)
- List of devices, their redirection state, and why they were allowed or denied

```

Administrator: Command Prompt
C:\Program Files\Citrix\HDX\bin>CtxUsbDiagnostics.exe

=====
          Session ID : 1
-----
          DDC rules - Version 1 :
-----
allow=0 flags=8 vendor=17e9
allow=0 flags=1 class=2
allow=0 flags=1 class=9
allow=0 flags=1 class=a
allow=0 flags=1 class=b
allow=0 flags=1 class=e0
allow=0 flags=3 class=ef subclass=4
allow=1 flags=0
allow=0 flags=3f class=0 subclass=0 protocol=0 vendor=0 product=0 release=0
allow=0 flags=3f class=0 subclass=0 protocol=0 vendor=0 product=0 release=0

-----
          Client default device rules :
-----
# Syntax is an ordered list of case insensitive rules where # is line comment
# and each rule is (ALLOW | DENY) : ( match )*
# and each match is (class|subclass|prot|vid|pid|rel) = hex-number
# Maximum hex value for class/subclass/prot is FF, and for vid/pid/rel is FFFF
DENY: vid=17e9 # All DisplayLink USB displays
CONNECT: vid=1188 pid=A101 # Bloomberg 5 Biometric module
DENY: vid=1188 pid=A001 split=01 intf=00 # Bloomberg 5 Primary keyboard
CONNECT: vid=1188 pid=A001 split=01 intf=01 # Bloomberg 5 Keyboard HID
DENY: vid=1188 pid=A301 split=01 intf=02 # Bloomberg 5 Keyboard Audio Channel
CONNECT: vid=1188 pid=A301 split=01 intf=00,01 # Bloomberg 5 Keyboard Audio HID
DENY: class=02 # Communications and CDC-Control
DENY: class=09 # Hub devices
DENY:vid=045e pid=079A # Microsoft Surface Pro 1 Touch Cover
DENY:vid=045e pid=079c # Microsoft Surface Pro 1 Type Cover
DENY:vid=045e pid=07dc # Microsoft Surface Pro 3 Type Cover
DENY:vid=045e pid=07dd # Microsoft Surface Pro JP 3 Type Cover
DENY:vid=045e pid=07de # Microsoft Surface Pro 3_2 Type Cover
DENY:vid=045e pid=07e2 # Microsoft Surface Pro 3 Type Cover
DENY:vid=045e pid=07e4 # Microsoft Surface Pro 4 Type Cover with fingerprint reader
DENY:vid=045e pid=07e8 # Microsoft Surface Pro 4_2 Type Cover
DENY:vid=03eb pid=8209 # Surface Pro Atmel maXTouch Digitizer
ALLOW:vid=056a pid=0315 class=03 # Wacom Intuos tablet

```

Note :

The administrator can see device information for all active sessions.

Information Displayed

- **Citrix Studio rules - Version 1/2**

- The DDC rules indicate the use of the legacy “**Client USB device redirection rules**” or “**Client USB device redirection rules (Version 2)**” policy in Studio. The information listed in this section lists all the rules configured by the Citrix admin.

```
C:\Program Files\Citrix\HDX\bin>CtxUsbDiagnostics.exe

=====
                Session ID : 1
-----
                DDC rules - Version 1 :
-----
allow=0 flags=8 vendor=17e9
allow=0 flags=1 class=2
```

- **Client Default Device Rules**

- This section lists the rules that are set in the registry on the client.

```
-----
Client default device rules :
-----
# Syntax is an ordered list of case insensitive rules where # is line comment
# and each rule is (ALLOW | DENY) : ( match ) *
# and each match is (class|subclass|prot|vid|pid|rel) = hex-number
# Maximum hex value for class/subclass/prot is FF, and for vid/pid/rel is FFFF
DENY: vid=17e9 # All DisplayLink USB displays
CONNECT: vid=1188 pid=A101 # Bloomberg 5 Biometric module
DENY: vid=1188 pid=A001 split=01 intf=00 # Bloomberg 5 Primary keyboard
CONNECT: vid=1188 pid=A001 split=01 intf=01 # Bloomberg 5 Keyboard HID
DENY: vid=1188 pid=A301 split=01 intf=02 # Bloomberg 5 Keyboard Audio Channel
CONNECT: vid=1188 pid=A301 split=01 intf=00,01 # Bloomberg 5 Keyboard Audio HID
DENY: class=02 # Communications and CDC-Control
DENY: class=09 # Hub devices
DENY:vid=045e pid=079A # Microsoft Surface Pro 1 Touch Cover
DENY:vid=045e pid=079c # Microsoft Surface Pro 1 Type Cover
DENY:vid=045e pid=07dc # Microsoft Surface Pro 3 Type Cover
DENY:vid=045e pid=07dd # Microsoft Surface Pro JP 3 Type Cover
DENY:vid=045e pid=07de # Microsoft Surface Pro 3_2 Type Cover
DENY:vid=045e pid=07e2 # Microsoft Surface Pro 3 Type Cover
DENY:vid=045e pid=07e4 # Microsoft Surface Pro 4 Type Cover with fingerprint reader
DENY:vid=045e pid=07e8 # Microsoft Surface Pro 4_2 Type Cover
DENY:vid=03eb pid=8209 # Surface Pro Atmel maXTouch Digitizer
ALLOW:vid=056a pid=0315 class=03 # Wacom Intuos tablet
ALLOW:vid=056a pid=0314 class=03 # Wacom Intuos tablet
ALLOW:vid=056a pid=00fb class=03 # Wacom DTU tablet
DENY: class=03 subclass=01 prot=01 # HID Boot keyboards
DENY: class=03 subclass=01 prot=02 # HID Boot mice
DENY: class=0a # CDC-Data
DENY: class=0b # Smartcard
DENY: class=e0 # Wireless controller
DENY: class=ef subclass=04 # Miscellaneous network devices
ALLOW: # Otherwise allow everything else
```

- **Device optimization rules**

- The section lists the device optimization rules as set in “Client USB device optimization rules.”

```

Administrator: Command Prompt
{
  "redirectionState": "Local",
  "deviceType": "generic",
  "isDenied": "true",
  "denyRule": "prot=01 subclass=01 class=03 allow=false ",
  "deniedByDDCV1": "true"
}
{
  "displayName": "Kensington SlimBlade Pro(2.4GHz Receiver) Kensington SlimBlade Pro Trackball(2.4GHz Receiver)",
  "deviceId": "7",
  "vid": "047d",
  "pid": "80d6",
  "release": "1333",
  "interfaces": [
    {
      "interfaceNum": "0",
      "class": "03",
      "subclass": "01",
      "protocol": "02"
    },
    {
      "interfaceNum": "1",
      "class": "03",
      "subclass": "01",
      "protocol": "01"
    }
  ],
  "redirectionState": "Local",
  "deviceType": "generic",
  "isDenied": "true",
  "denyRule": "prot=01 subclass=01 class=03 allow=false "
}

-----
Device optimization rules
-----
Mode=00000001 VID=1230 PID=1230 class=03 #Sample rsoori
-----

C:\Users\Administrator.X2RLS>

```

Device List

This section lists valuable information about each device that is connected to the client endpoint, the hardware information, whether it is being redirected or not, whether the correct device redirection rule is set or not, and so on.

| Tag Name | Description |
|--------------|---|
| displayName | Lists the common name of the device. |
| vid | Vendor ID |
| pid | Product ID |
| Interfaces | This subsection lists all the interfaces in case the composite device has been split into multiple child devices. |
| InterfaceNum | Indicates the index of the interface descriptor |
| class | Class code |
| subclass | Subclass Code |

| Tag Name | Description |
|------------------|---|
| protocol | Protocol |
| redirectionState | Local indicates that the device is not redirected in the ICA session. ThisSession indicates that the device is redirected in the ICA session. OtherSession indicates that the device is redirected in another ICA session. |
| optiEnabled | true indicates that the device is optimized. false indicates that the device is not optimized and the data transfer happens over the USB virtual channel. |
| deviceType | generic indicates that the device does not have an optimized virtual channel and the traffic is flowing through the USB virtual channel. optimized implies that the data transfer associated with the device is happening over a dedicated virtual channel. |
| isDenied | true indicates that the device is not redirected because of a policy rule set by the admin. false indicates that the device is redirected because of applied policy. |
| denyRule | This field is useful if isDenied is set to true . It tells the admin the specific rule set in the policy that is resulting in the device not getting redirected. |

Legacy USB Redirection Configuration

April 16, 2024

If you are using any components older than version 2212 or if you are using CWA for Linux, follow this guide for configuring USB redirection in your environment.

Enabling Generic USB Redirection

1. Open **Citrix Web Studio policies** and click on the **Policies** tab.

2. Click on **Create Policy** and expand the **ICA > USB Devices policies**.
3. Edit the **Client USB device redirection policy**.
4. Select **Allowed** and click **Save**.

Creating USB Redirection Policy Rules

When the user tries to redirect a USB device to Virtual Desktop, it is checked against each USB policy rule in turn until a match is found. The first match for any devices is considered final. If the first match is an Allow rule, the matched device is allowed to be redirected to the virtual desktop. If the first match is a Deny rule, the matched device is only available in the local desktop. If no match is found, default rules are used.

Setting the policy on the DDC:

1. Open **Citrix Web Studio policies** and click on the **Policies** tab.
2. Click on **Create Policy** and expand the **ICA > USB Devices policies**.
3. Edit the **Client USB device redirection rules**.
4. Set the value based on the examples provided in the description for each usb device that needs to be redirected and click Save.

For Example:

Allow: VID=056A PID=00A4 #STU-430

Deny: Class=08 subclass=05 # Mass Storage

Note:

If a Citrix admin checks Use default value and clicks on Save, the default rules can be found in the following registry in the VDA.

Caution!:

Refer to the Disclaimer at the end of this article before using the Registry Editor.

[HKLM\SOFTWARE\Wow6432Node\Citrix\PortICA\GenericUSB\DeviceRules](#)

Using GPOs on the client:

1. Open the **Local Group Policy Editor** and go to **Administrative Templates > Citrix Components > Citrix Receiver > Remoting client devices > Generic USB Remoting**.
2. Open the **USB Device Rules setting** and enable the setting. Add the USB Device rule as in this example,
The Allow: VID=1230 PID=0007 rule allows the device with Vendor ID 1230 and Product ID 0007.

Note:

Use the Allow: VID=xxxx PID=xxxx rule when a specific device must be on top of the device rules list.

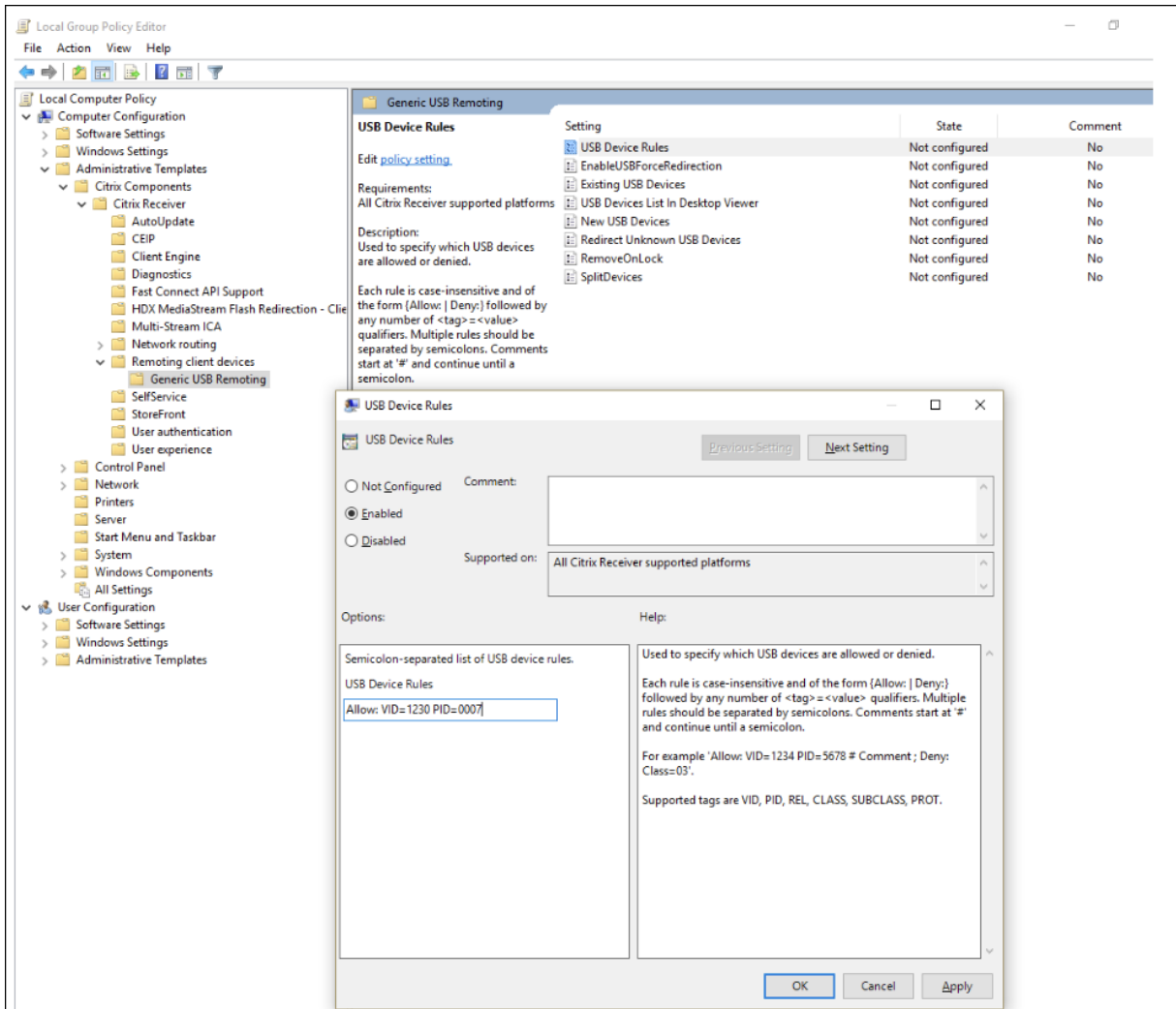

Note:

A tool like USBView or even the Connection toolbar can be used to determine the device details like VID and PID (include SS here).

Configure automatic redirection of USB devices

USB devices are automatically redirected when USB support is enabled. Also, the USB user preference settings are set to automatically connect USB devices. It is not always best to redirect all USB devices. Users can explicitly redirect devices from the USB device list that are not automatically redirected. To

prevent USB devices from being listed or redirected, use DeviceRules on either the client endpoint or the DDC policy.

This policy can be set either on the DDC, on the client using a GPO, using Citrix Workspace Preferences or the Connections tab under CDViewer. All of these methods are described below:

Setting the policy on the DDC:

There are two policies on the DDC that can be set to allow auto redirection of USB devices- ‘Allow existing USB devices to be automatically connected, Allow newly arrived USB devices to be automatically connected’

1. Open **Citrix Web Studio policies** and click on the **Policies** tab.
2. Click on **Create Policy** and expand the **ICA > USB Devices policies**.
3. Edit the setting **Allow existing USB devices to be automatically connected**.
4. Clear the **Use default value** checkbox and select **Automatically redirect available USB devices** from the drop down menu and click **Save**.
5. Edit the setting **Allow newly arrived USB devices to be automatically connected**.
6. Clear the **Use default value** checkbox and select **Automatically redirect available USB devices** from the drop down menu and click **Save**.

Using GPOs on the client:

1. Open **Local Group Policy Editor** and go to **Administrative Templates > Citrix Components > Citrix Receiver > Remoting client devices > Generic USB Remoting**.
2. Open **New USB Devices**, select **Enabled**, and click **OK**.
3. Open **Existing USB Devices**, select **Enabled**, and click **OK**.

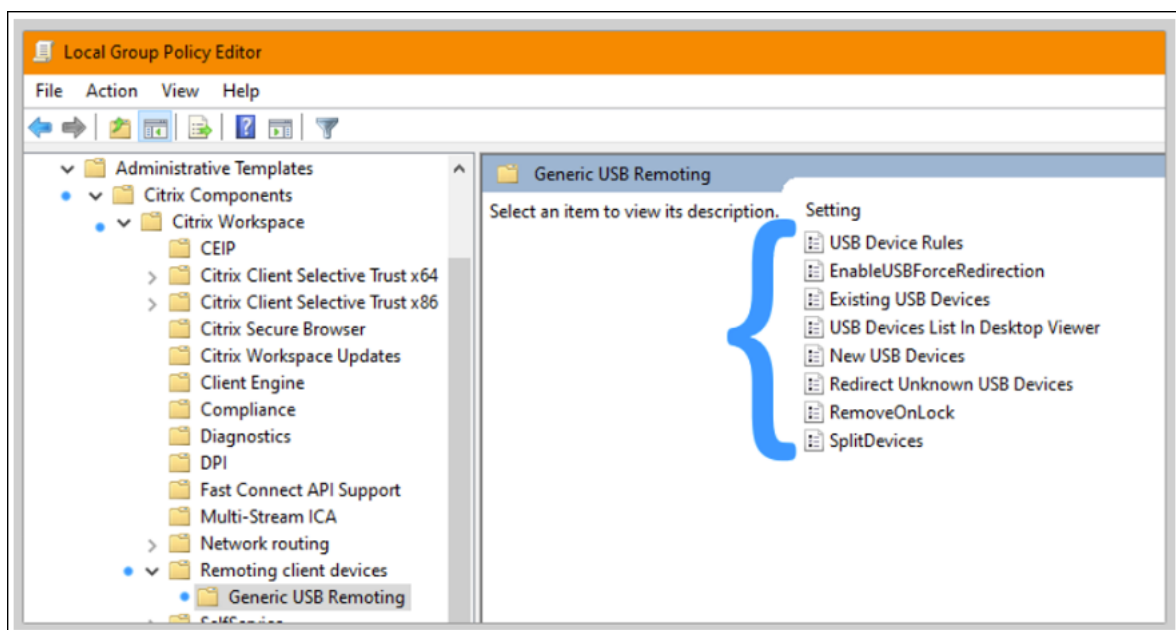

Using Citrix Connection Center:

1. Go to **Citrix Workspace Preferences > Connections**.
2. Ensure that the following options are selected:
 - a) When a session starts, connect devices automatically
 - b) When a new device is connected while a session is running, connect the device automatically.
3. Click **OK**.

Using CDViewer Connection toolbar:

1. After a session starts, click on the **CDViewer** dropdown and select the **Citrix Workspace Preferences > Connections** tab.
2. Ensure that the following options are selected:
 - a) When a session starts, connect devices automatically
 - b) When a new device is connected while a session is running, connect the device automatically.
3. Click **Apply** and **OK** to save the policy.

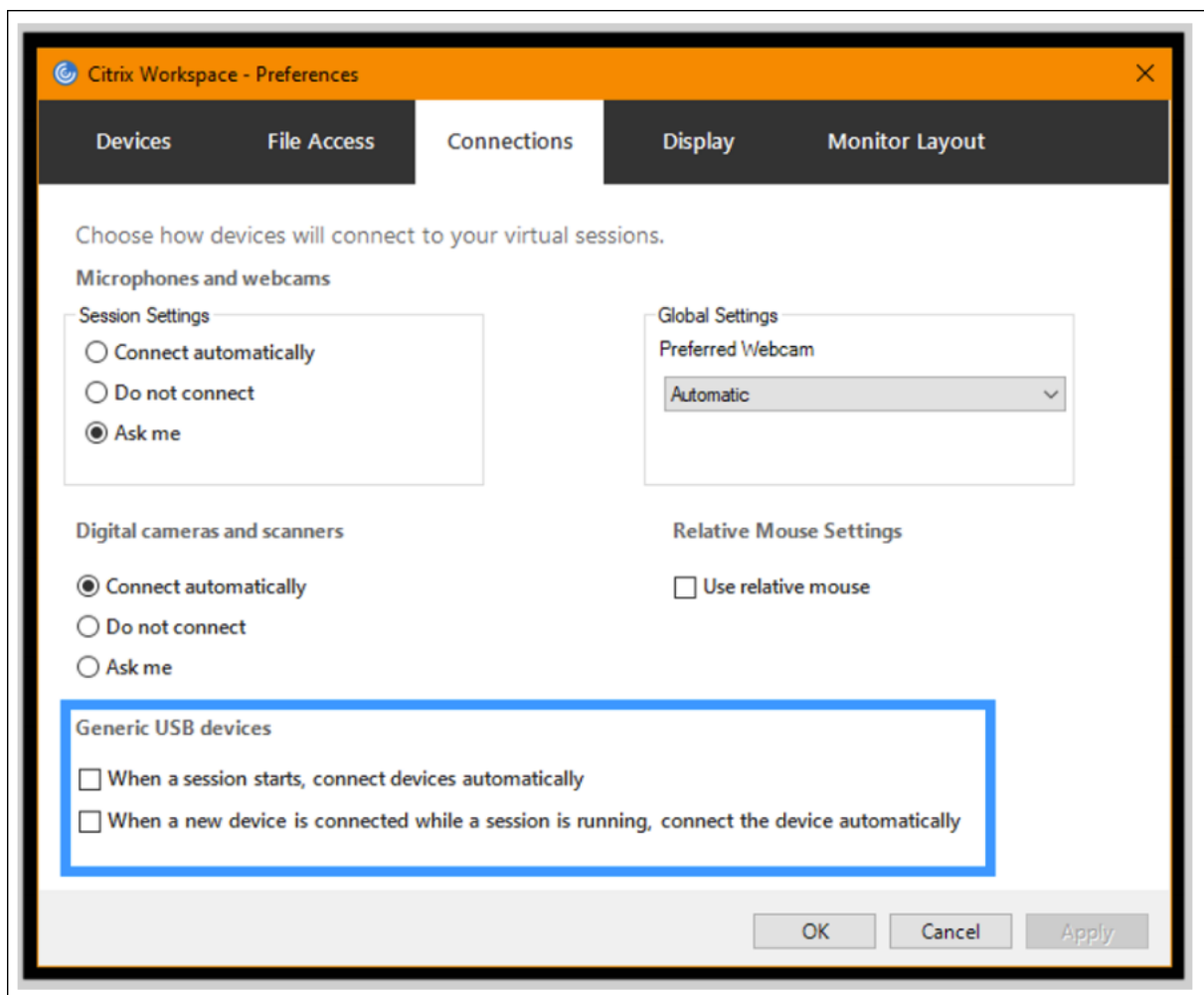

For the client based configurations, the registry keys are set to the client device at the following location:

Caution!:

Refer to the Disclaimer at the end of this article before using the Registry Editor.

HKLM\SOFTWARE\Wow6432Node\Citrix\ICA Client\GenericUSB

Client Drive Mapping (CDM)

August 3, 2023

Client Drive Mapping makes storage drives on the client endpoint available inside a Citrix HDX session to allow files and folders to be transferred from the client to the session host, and vice versa. This feature is enabled by default with both read and write privileges. To prevent users from adding or changing files and folders on mapped client-devices, enable the **Read-only client drive access** policy setting. When adding this setting to a policy, ensure that the **Client drive redirection** setting is set to **Allowed** and is also added to the policy.

As a security precaution, endpoint drives are mapped without the run permission by default. To allow users to run executables directly from the mapped client drives, edit the **ExecuteFromMappedDrive** registry value in the session host. For details, see [Mapped client drives](#) in the **HDX features managed through the registry** section.

Requirements

The following are the requirements for using CDM:

Citrix Control plane

- Citrix Virtual Apps and Desktops 1912 or later
- Citrix DaaS

Session host

- Operating system
 - Windows 10 1809 or later
 - Windows Server 2016 or later

- Linux: Please refer to the Linux VDA [system requirements](#)
- VDA
 - Windows: Citrix Virtual Apps and Desktops 1912 or later
 - Linux: Please refer to the Linux VDA [documentation](#)

Client device

- Operating system
 - Windows 10 1809 or later
 - Linux: Please refer to the Workspace app for Linux [system requirements](#)

Related Policies

Please refer to [Policy settings reference](#) section for CDM settings.

Double-hop scenarios

CDM is supported in double-hop scenarios. By default, the client endpoint's drive is mapped to the second hop session and the first hop's drives are not available. However, this can be set so that the first hop's drives are mapped in the second hop's session instead of the client endpoint's drives.

To configure this functionality, edit the following registry value:

- Key: HKEY_LOCAL_MACHINE\SOFTWARE\WOW6432Node\Citrix\ICA Client\Engine\Configuration\Advanced
- Value name: NativeDriveMapping
- Value type: REG_SZ
- Value data:
 - True - Maps the drives of the first hop session in the second hop session
 - False - Maps the drives of the client endpoint in the second hop session

Note:

Editing the registry incorrectly can cause serious problems that might require you to reinstall your operating system. Citrix cannot guarantee that problems resulting from the incorrect use of the Registry Editor can be solved. Use Registry Editor at your own risk. Be sure to back up the registry before you edit it.

Support for mobile and touch screen client devices

February 12, 2024

Citrix Virtual Apps and Desktops enables users to access their published applications and desktops from mobile and touch screen client devices.

Requirements

Citrix control plane

- Citrix Virtual Apps and Desktops 1912 or later
- Citrix DaaS

Session host

- Operating system
 - Windows 10 1903 or later
 - Windows 11 21H2 or later
 - Windows Server 2016 or later
- VDA
 - Windows: Citrix Virtual Apps and Desktops version 7.15 or later

Client device

- Operating system
 - Windows 10 1809 or later
 - Windows 11 21H2 or later
- Citrix Workspace app for Windows version 1808 or later

Tablet mode for touch screen devices using Windows Continuum

Continuum is a Windows 10 feature that adapts to the way the client device is used. When the VDA detects the presence of a keyboard or mouse on a touch enabled client, it puts the client in to desktop mode. If a keyboard or mouse is not present, the VDA puts the client in to tablet/mobile mode. This

detection occurs on session connection and reconnection and also in-session when the keyboard or mouse is attached or detached.

The feature is enabled by default. To disable this feature, configure the policy settings [Tablet mode toggle policy settings](#).

In addition to the requirements for touch screen devices mentioned above, the following are required for Windows Continuum:

XenServer (formerly Citrix Hypervisor)

- Citrix Hypervisor 8.2 or higher
- Run the XenServer CLI command to allow laptop/tablet switching:
xe vm-param-set uuid=<VM_UUID> platform:acpi_laptop_slate=1

Important:

Updating the base image for an existing machine catalog after changing the metadata setting doesn't affect any previously provisioned VMs. After changing the XenServer VM base image, create a catalog, choose the base image, and provision a new Machine Creation Services (MCS) machine.

Session host

- Operating system
 - Windows 10 1903 or later
 - Windows 11 21H2 or later
- VDA
 - Windows: version 7.16 or later
 - **Due to current limitations in the Operating system configurations, the user will have to set the following options from the drop-down menus after they start the first ICA session and restart the VDA:**
 - * **Settings > System > Tablet Mode**
 - Use the appropriate mode for my hardware
 - Don't ask me and always switch

The **tablet mode** offers a user interface that is better suited to touch screens:

- Slightly larger buttons.
- The Start screen and any apps you start open in a full screen.
- Taskbar contains a back button.

- Icons deleted from the task bar.

You have access to the File Explorer.

Windows 10 loads the GPIO driver on the target virtual machine based on this updated BIOS. It is used for toggling between tablet and desktop modes within the virtual machine.

Citrix Workspace app for HTML5 does not support Windows Continuum features.

The **desktop mode** offers the traditional user interface where you interact in the same manner as using PC and a keyboard and mouse.

Microsoft Surface Pro and Surface Book pens

We support standard pen functionality with Windows Ink-based applications. Support includes pointing, erasing, pen pressure, Bluetooth signals, and other features depending on the operating system firmware and pen model. For example, pen pressure can be up to 4096 levels. This feature is enabled by default.

The following are the requirements for pen functionality support:

Citrix control plane

- Citrix Virtual Apps and Desktops 1903 or later
- Citrix DaaS

Session host

- Operating system
 - Windows 10 1809 or later
 - Windows 11 21H2 or later
 - Windows Server 2016 or later
- VDA
 - Windows: Citrix Virtual Apps and Desktops 1903 or later

Client device

- Operating system
 - Windows 10 1809 or later
 - Windows 11 21H2 or later

- Citrix Workspace app for Windows version 1902 or later

For a demonstration of Windows Ink and the pen functionality, click this graphic:

To disable or enable this feature, see [Microsoft Surface Pro and Surface Book pens](#) in the list of features managed through the registry.

Known issues

The following are known issues with Pen support:

- Due to OS limitations in Windows server 2k22, users will not be able to set pen shortcuts or make adjustments to pen/ink settings in Control Panel when connecting to 2k22 server applications or desktops.
- Pen shortcuts are not being honored from a pen enabled Windows 11 client due to OS limitation.

Serial ports

October 30, 2020

Most new PCs don't have built-in serial (COM) ports. The ports are easy to add by using USB converters. Applications suited for serial ports often involve sensors, controllers, old check readers, pads, and so forth. Some USB virtual COM-port devices use vendor-specific drivers in place of the Windows-provided drivers (usbser.sys). These drivers allow you to force the virtual COM port of the USB device so that it doesn't change even if connected to different USB sockets. This might be done from the **Device Manager > Ports (COM & LPT) > Properties** or from the application that controls the device.

Client COM port mapping allows devices attached to the COM ports on the user's endpoint to be used during virtual sessions. You can use these mappings like any other network mappings.

For each COM port, a driver in the operating system assigns a symbolic link name such as COM1 and COM2. The applications then use the link to access the port.

Important:

Because a device can attach to the endpoint by using USB directly, doesn't mean it can be redirected using generic USB redirection. Some USB devices function as virtual COM ports, which applications can access in the same way as physical serial port. The operating system can abstract COM ports and treat them like fileshares. Two common protocols for virtual COM are CDC ACM or MCT. When connected through an RS-485 port, applications might not work at all. Get an

RS-485-to-RS232 converter to use RS-485 as a COM port.

Important:

Some applications recognize the device (for example, a signature pad) consistently only if it is connected to COM1 or COM2 on the client workstation.

Map a client COM port to a server COM port

You can map client COM ports to a Citrix session in three ways:

- Studio policies. For more information about policies, see [Port redirection policy settings](#).
 - VDA command prompt.
 - Remote Desktop (Terminal Services) configuration tool.
1. Enable the **Client COM port redirection** and the **Auto connect client COM ports Studio** policies. After applied, some information is available in HDX Monitor.

The screenshot shows the HDX Monitor 3.5 interface for session FTLPD77M0SD1374. The left sidebar lists various categories, with 'Client Device' selected. The main area displays a table of client device properties.

| Name | Value |
|----------------------------------|-----------------|
| HardwareId | 1591092831 |
| InternetClient | False |
| LastError | |
| Name | FTLLFERNANDOK02 |
| Policy_AutoConnectClientComPorts | False |
| Policy_AutoConnectClientLptPorts | False |
| ... | ... |
| Attributes | WMI |

2. If **Auto connect client COM ports** failed to map the port, you can map the port manually or use logon scripts. Log on to the VDA, and at a command prompt window, type:

```
NET USE COMX: \\CLIENT\COMZ:
```

Or

```
NET USE COMX: \\CLIENT\CLIENTPORT:COMZ:
```

X is the number of the COM port on the VDA (ports 1 through 9 are available for mapping). **Z** is the number of the client COM port you want to map.

To confirm that the operation was successful, type **NET USE** at a VDA command prompt. The list that appears contains mapped drives, LPT ports, and mapped COM ports.

```
C:\Windows\system32>net use
New connections will be remembered.

Status          Local          Remote          Network
-----
COM3            \\Client\COM3: Citrix Client Network
```

3. To use this COM port in a virtual desktop or application, install your user device application and point it to the mapped COM port name. For example, if you map COM1 on the client to COM3 on the server, install your COM port device application in the VDA and point it to COM3 during the session. Use this mapped COM port as you would a COM port on the user device.

Important:

COM port mapping is not TAPI-compatible. You can't map Windows Telephony Application Programming Interface (TAPI) devices to client COM ports. TAPI defines a standard way for applications to control telephone functions for data, fax, and voice calls. TAPI manages signaling, including dialing, answering, and ending calls. Also, supplemental services such as holding, transferring, and conference calls.

Troubleshoot

1. Ensure you can access the device directly from the endpoint, bypassing Citrix. While the port is not mapped to the VDA, you are not connected to a Citrix session. Follow any troubleshooting instructions that came with the device and verify that it works locally first.

When a device is connected to a serial COM port, a registry key is created on the hive shown here:

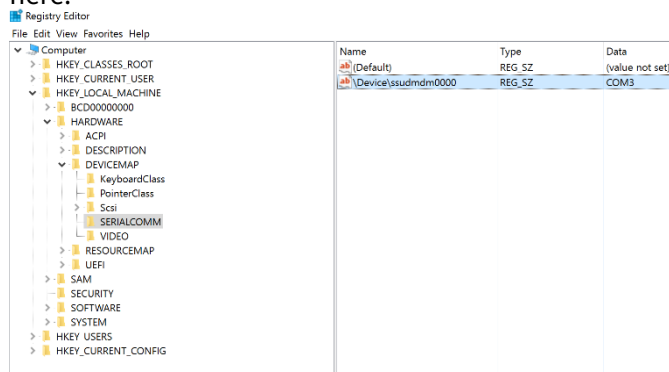

You can also find this information from the command prompt by running **chgport /query**.

```
C:\Windows\system32\cmd.exe
C:\Users\fernandok>chgpport /query
COM3 = \Device\ssudmdm0000

C:\Users\fernandok>mode

Status for device COM3:
-----
      Baud:                1200
      Parity:              Even
      Data Bits:           7
      Stop Bits:           1
      Timeout:             OFF
      XON/XOFF:            OFF
      CTS handshaking:    OFF
      DSR handshaking:    OFF
      DSR sensitivity:    OFF
      DTR circuit:        ON
      RTS circuit:        ON
```

If troubleshooting instructions for the device aren't available, try opening a PuTTY session. Choose **Session** and in **Serial line** specify your COM Port.

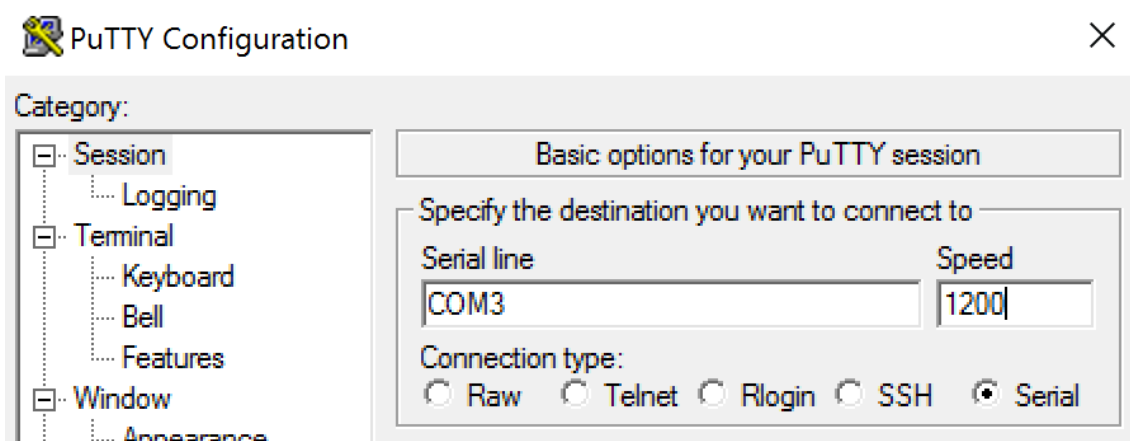

You can run **MODE** in a local command window. The output might display the COM port in use and the Baud/Parity/Data Bits/Stop Bits, which you need in your PuTTY session. If the PuTTY connection is successful, press **Enter** to see feedback from the device. Whatever characters you type might be repeated on the screen, or responded to. If this step is unsuccessful, you can't access the device from a virtual session.

2. Map the local COM port to the VDA (using policies or **NET USE COMX: \\CLIENT\COMZ:**) and repeat the same PuTTY procedures in the previous step, but this time from the VDA PuTTY. If PuTTY fails to show the error **Unable to open connection to COM1. Unable to open serial port**, another device might be using COM1.
3. Run **chgpport /query**. If the built-in Windows serial driver on the VDA is auto-assigning \Device\Serial0 to a COM1 port of your VDA, do the following:
 - A. Open CMD on the VDA and type **NET USE**.
 - B. Delete any existing mapping (for example, COM1) on the VDA.

NET USE COM1 /DELETE

- C. Map the device to the VDA.

NET USE COM1: \\CLIENT\COM3:

- D. Point your application on the VDA to COM3.

Lastly, try to map your local COM port (for example, COM3) to a different COM port on the VDA (other than COM1, for example COM3). Ensure that your application is pointing to it:

NET USE COM3: \\CLIENT\COM3

4. If now you do see the port mapped, PuTTY is working but no data passing, it might be a race condition. The application might connect and open the port before it is mapped, locking it from being mapped. Try one of the following:
 - Open a second application published on the same server. Wait a few seconds for the port to be mapped, and then open the real application that tries to use the port.

- Enable the COM port redirection policies from the Group Policy Editor in Active Directory instead of Studio. Those policies are **Client COM port redirection** and **Auto connect client COM ports**. Policies applied this way might be processed before the Studio policies, guaranteeing that the COM port is mapped. Citrix policies are pushed to the VDA and stored in: `HKLN\SOFTWARE\Policies\Citrix \<user session ID\>`
- Use this logon script for the user or instead of publishing the application, publish a .bat script that first deletes any mapping on the VDA, remaps the virtual COM port, and then starts the application:

```
@echo off
NET USE COM1 /delete
NET USE COM2 /delete
NET USE COM1: \\CLIENT\COM1:
NET USE COM2: \\CLIENT\COM2:
MODE COM1: BAUD=1200 (or whatever value needed)
MODE COM2: BAUD=9600 PARITY=N Data=8 Stop=1 (or whatever value needed)
START C:\Program Files\<Your Software Path>\<your_software.exe>
```

5. Process Monitor from Sysinternals is the tool of last resort. When running the tool on the VDA, find and filter objects like COM3, picaser.sys, CdmRedirector, but especially <your_app>.exe. Any errors might appear as Access Denied or similar.

Specialty keyboards

April 10, 2023

Bloomberg keyboards

Warning:

Editing the registry incorrectly can cause serious problems that might require you to reinstall your operating system. Citrix cannot guarantee that problems resulting from the incorrect use of Registry Editor can be solved. Use Registry Editor at your own risk. Be sure to back up the registry before you edit it.

Citrix Virtual Apps and Desktops supports the Bloomberg model 5, model 4 Starboard keyboard (and earlier model 3). This keyboard enables customers in the financial sector to use the special features of the keyboard to access financial market data and perform trading quickly.

Important:

We recommend that you use the Bloomberg keyboard with only one session. We don't recommend using the keyboard with multiple concurrent sessions (one client to multiple sessions).

The Bloomberg keyboard is a USB composite device comprising multiple USB devices in one physical shell:

- Keyboard.
- Fingerprint reader.
- Audio device with keys to increase and decrease volume and mute the speaker and the microphone. This device includes onboard speaker, microphone, and jack for the microphone and headset.
- USB hub to connect all of these devices to the system.

Requirements:

- The session to which Citrix Workspace app for Windows is connecting must support USB devices.
- Minimum of Citrix Workspace app 2207 for Linux to support Bloomberg keyboard model 5.
- Minimum of Citrix Workspace app 2109 for Windows to support Bloomberg keyboard model 5.
- Minimum of Citrix Workspace app 1808 for Windows or Citrix Receiver for Windows 4.8 to support Bloomberg keyboard model 3 and 4.
- Minimum of Citrix Workspace app 1808 for Windows or Citrix Receiver for Windows 4.12 to use KVM mode (two USB cables with one routed through KVM) for Model 4.

For information about configuring Bloomberg keyboards on Citrix Workspace app for Windows, see [Configuring Bloomberg keyboards](#).

To enable Bloomberg keyboard support, see [Bloomberg keyboards](#) in the list of features managed through the registry.

Verify support:

To determine if Bloomberg keyboard support is enabled in Citrix Workspace app, check if the Desktop Viewer correctly reports the Bloomberg keyboard's devices.

Desktop scenario:

Open the Desktop Viewer. If support for Bloomberg keyboard is enabled, the Desktop Viewer shows see three devices under the USB icon:

For Bloomberg 5 keyboard:

- Bloomberg LP Bloomberg Biometric Module
- Bloomberg LP Keyboard (Composite device with two interfaces)

- Bloomberg LP Keyboard Audio (Composite device with three interfaces)

For Bloomberg 3 and 4 keyboards:

- Bloomberg Fingerprint Scanner
- Bloomberg Keyboard Features
- Bloomberg LP Keyboard 2013

Seamless Application only scenario:

Open the **Connection Center** menu from the Citrix Workspace app notification area icon. If support for the Bloomberg keyboard is enabled, the three devices appear in the **Devices** menu.

The check mark against each of these devices indicates that they are remoted to the session.

Webcams

August 9, 2022

High definition webcam streaming

Webcams can be used by video conferencing applications running within the virtual session. The application on the server selects the webcam format and resolution based on the supported format types. When a session starts, the client sends the webcam information to the server. Choose a webcam from the video conferencing application. When the webcam and the application both support high-definition rendering, the application uses high-definition resolution. We support webcam resolutions up to 1920x1080.

This feature requires the Citrix Receiver for Windows, minimum version 4.10. For a list of Citrix Workspace app platforms that support HDX webcam redirection, see [Citrix Workspace app feature matrix](#).

For more information about high-definition webcam streaming, see [HDX video conferencing and webcam video compression](#).

You can use a registry key to disable and enable the feature and then configure a specific resolution. For information, see [High-definition webcam streaming and High-definition webcam resolution](#) in the list of features managed through the registry.

Graphics

December 21, 2023

Citrix HDX graphics include an extensive set of graphics acceleration and encoding technologies that optimizes the delivery of rich graphics applications from Citrix Virtual Apps and Desktops. The graphic technologies provide the same experience as using a physical desktop when working remotely with virtual applications that are graphics intensive.

You can use software or hardware for graphics rendering. Software rendering requires a third-party library called software rasterizer. For example, Windows includes the WARP rasterizer for DirectX based graphics. Sometimes, you might want to use an alternative software renderer. Hardware rendering (hardware acceleration) requires a graphics processor (GPU).

HDX Graphics offers a default encoding configuration that is optimized for the most common use cases. By using Citrix policies, IT administrators can also configure various graphics-related settings to meet different requirements and provide the desired user experience.

Thinwire

Thinwire is the Citrix default display remoting technology used in Citrix Virtual Apps and Desktops.

Display remoting technology allows graphics generated on one machine to be transmitted, typically across a network, to another machine for display. Graphics are generated as a result of user input, for example, keystrokes or mouse actions.

HDX 3D Pro

The HDX 3D Pro capabilities in Citrix Virtual Apps and Desktops enable you to deliver desktops and applications that perform best using a graphics processing unit (GPU) for hardware acceleration. These applications include 3D professional graphics applications based on OpenGL and DirectX. The standard VDA supports GPU acceleration of DirectX only.

GPU acceleration for Windows Single-session OS

By using HDX 3D Pro, you can deliver graphically intensive applications as part of hosted desktops or applications on Single-session OS machines. HDX 3D Pro supports physical host computers (including desktop, blade, and rack workstations) and GPU Passthrough and GPU virtualization technologies offered by XenServer, vSphere, and Hyper-V (passthrough only) hypervisors.

Using GPU Passthrough, you can create VMs that have exclusive access to dedicated graphics processing hardware. You can install multiple GPUs on the hypervisor and assign VMs to each of these GPUs on a one-to-one basis.

Using GPU virtualization, multiple virtual machines can directly access the graphics processing power of a single physical GPU.

GPU acceleration for Windows Multi-session OS

HDX 3D Pro allows graphics-heavy applications running in Windows Multi-session OS sessions to render on the server graphics processing unit (GPU). By moving OpenGL, DirectX, Direct3D, and Windows Presentation Foundation (WPF) rendering to the server GPU, graphics rendering doesn't slow down the server CPU. Also, the server is able to process more graphics because the workload is split among the CPU and GPU.

Framehawk

Important:

As of Citrix Virtual Apps and Desktops 7 1903, Framehawk is no longer supported. Instead, use [Thinwire](#) with [adaptive transport](#) enabled.

Framehawk is a display remoting technology for mobile workers on broadband wireless connections (Wi-Fi and 4G/LTE cellular networks). Framehawk overcomes the challenges of spectral interference and multipath propagation and delivers a fluid and interactive user experience to users of virtual apps and desktops.

Text-based session watermark

Text-based session watermarks help to deter and enable tracking data theft. This traceable information appears on the session desktop as a deterrent to those using photographs and screen captures to steal data. You can specify a watermark that is a layer of text. The watermark can display over the entire session screen without changing the content of the original document. Text-based session watermarks require VDA support.

Adaptive Refresh Rate

With the new scalability improvements, HDX matches the refresh rate of virtual monitors to match the target FPS policy set. Adaptive Refresh Rate (ARR) is available for both single and multisession VDAs, and works for both GPU-accelerated and non-GPU scenarios.

loss tolerant mode

The loss tolerant mode is thoroughly reworked to ensure the session remains interactive when packet loss is detected.

Related information

- [HDX 3D Pro](#)
- [GPU acceleration for Windows Single-session OS](#)
- [GPU acceleration for Windows Multi-session OS](#)
- [Framehawk](#)
- [Thinwire](#)
- [Text-based session watermark](#)

10-Bit High Dynamic Range (HDR)

January 25, 2024

With 10-bit High Dynamic Range (HDR) virtual desktop sessions, you can use enhanced encoding and decoding capabilities to render high-quality images and videos with an extended range of colors, and greater contrast and brightness. Also, you can customize the white luminance level, Extended Display Identification Data (EDID), and visual quality to improve the user experience.

System requirements

Endpoint:

- Citrix Workspace app for Windows 2209 or later for NVIDIA GPUs
- NVIDIA GPUs with 10-bit HEVC (H.265) 444 decoding support on the endpoint
- 10-bit HDR-supported monitors, 10-bit HDR must be enabled on all monitors using display settings.

Server:

- Windows single-session OS VDA 2209 or later for NVIDIA GPUs, and VDA 2308 or later for Intel GPUs
- NVIDIA GPUs with 10-bit HEVC 444 encoding support on the VDA

Required policies

Endpoint:

- Enable H.265 decoding for graphics

Server:

- Optimize for 3D Graphics workload
- Graphics Status Indicator (optional)

Server configurations

Launching a Citrix session on a 10-bit HDR-enabled endpoint monitor enables the HDR session by default. In multi-monitor HDR sessions, all endpoint monitors must have 10-bit HDR enabled. HDR sessions are supported in both windowed and full-screen modes.

Reference White Level

This setting defines the white luminance level by nit value. It controls the relative HDR screen brightness within the session. The default value is 80 nits. Set the following registry key to define a different nit value:

- HKEY_LOCAL_MACHINE\SOFTWARE\Citrix\Graphics
- Type: REG_DWORD
- Name: RefWhiteLevel

To activate the setting, you must either resize your session or disconnect and relaunch the session.

EDID override

You can configure the VDA to use the endpoint monitor EDID for your HDR sessions. This allows you to fully utilize the monitor's display capabilities by matching the color gamut and luminance range. By default, HDR sessions assume an HDR1000-capable display.

You can export endpoint monitor EDID using NVIDIA or other tools. Apply it to the VDA using the following registry key:

- HKEY_LOCAL_MACHINE\SOFTWARE\Citrix\Graphics
- Type: REG_BINARY
- Name: EDIDOverride

When you store the EDID in the registry, it must not have commas, spaces, or special characters. To activate the override EDID, sign out and launch a new session.

Visual lossless experience

Enable the following policies for a visually lossless experience:

- Allow Visual Lossless Compression
- Visual Quality: Always Lossless or Build to Lossless

After the policies are set, you can control the HDR session quality using the Graphics Status Indicator by using the Image Quality Slider, or by switching to pixel-perfect mode.

Allow Windows screen lock

You can use this policy to allow all Windows display timeouts, including screen lock, to apply to a Citrix Virtual Desktop session on Workstation OS. This setting can be set using a Citrix Group Policy Object in Citrix Studio.

By default, when this setting is not enabled, a Citrix Virtual Desktop does not respond to timeouts for session lock, screensaver, or display off, during an active session.

When a password-protected screensaver is configured on a Workstation VDA, this setting must be enabled to allow the Citrix Virtual Desktop session to be automatically locked when the screen saver timeout is reached.

Enabling this setting when a display-off timeout is configured on the VDA causes the expiration of that timeout to result in a session that does not update until the user resumes interaction with the session. For instance, any time displayed is not updated, and new notifications are not displayed.

Other considerations

- You can launch 10-bit HDR sessions on up to four monitors on virtual GPUs.
- The Citrix session reverts to an 8-bit, non-HDR mode in the following instances:
 - If any endpoint monitors do not have 10-bit HDR enabled
 - Enabling screen sharing.
 - Setting a virtual display layout on the VDA.
 - Switching to pixel-perfect mode without setting the **Allow Visually Lossless Compression** policy.

HDX 3D Pro

December 7, 2023

The HDX 3D Pro capabilities of Citrix Virtual Apps and Desktops enable you to deliver desktops and applications that perform best using a graphics processing unit (GPU) for hardware acceleration. These applications include 3D professional graphics applications based on OpenGL and DirectX. The standard VDA supports GPU acceleration of DirectX only.

For the HDX 3D Pro policy settings, see [Optimize for 3D graphics workload](#).

All supported Citrix Workspace apps can be used with 3D graphics. For best performance with complex 3D workloads, high-resolution monitors, multi-monitor configurations, and high frame rate applications, we recommend the latest versions of Citrix Workspace app for Windows and Citrix Workspace app for Linux. For more information on supported versions of Citrix Workspace app, see [Lifecycle Milestones for Citrix Workspace app](#).

Examples of 3D professional applications include:

- Computer-aided design, manufacturing, and engineering (CAD/CAM/CAE) applications

- Geographical Information System (GIS) software
- Picture Archiving Communication System (PACS) for medical imaging
- Applications using the latest OpenGL, DirectX, NVIDIA CUDA, and OpenCL and WebGL versions
- Computationally intensive non-graphical applications that use NVIDIA Compute Unified Device Architecture (CUDA) GPUs for parallel computing

HDX 3D Pro provides the best user experience over any bandwidth:

- On WAN connections: Deliver an interactive user experience over WAN connections with bandwidths as low as 1.5 Mbps.
- On LAN connections: Deliver a user experience equivalent to that of a local desktop on LAN connections.

You can replace complex and expensive workstations with simpler user devices by moving the graphics processing into the data center for centralized management.

Lossless compression option for specialized use cases

HDX 3D Pro also offers a CPU-based lossless codec to support applications where pixel-perfect graphics are required, such as medical imaging. True lossless compression is recommended only for specialized use cases because it consumes more network and processing resources.

When using lossless compression:

- The lossless indicator in the Graphic Status Indicator, a notification area icon, notifies the user if the screen displayed is a lossy frame or a lossless frame. This icon helps when the **Visual Quality** policy setting specifies **Build to lossless**. The lossless indicator turns green when the frames sent are lossless.

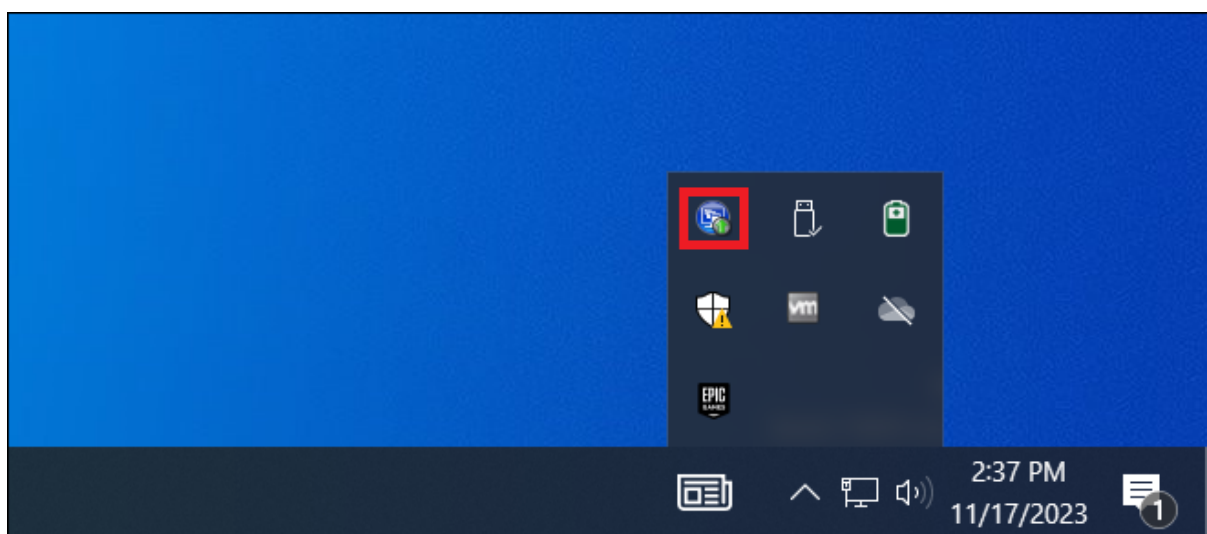

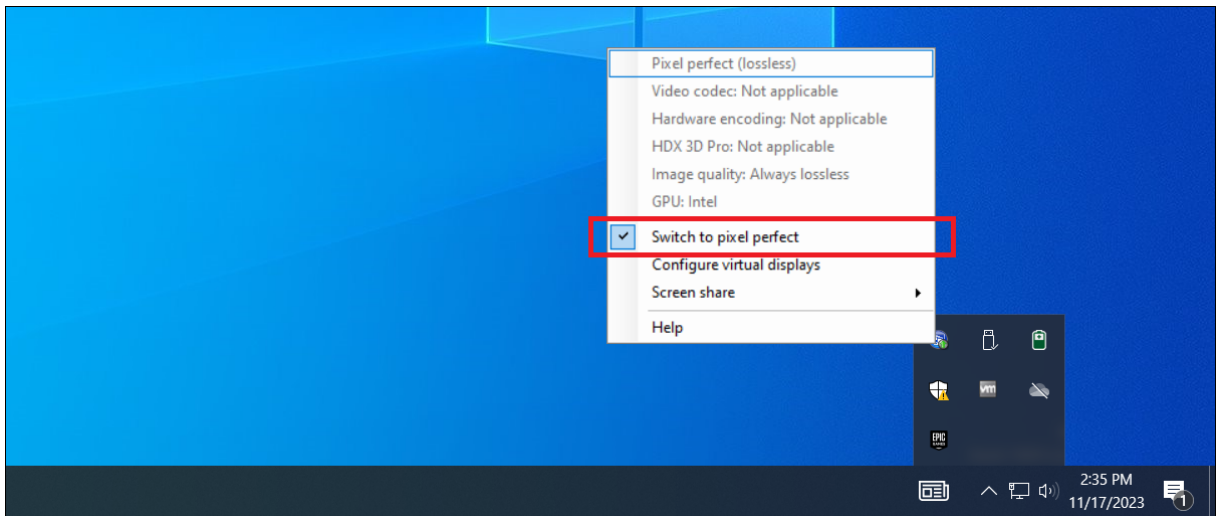

- The lossless switch enables the user to change to the **Always Lossless** mode anytime within the session. To select or clear **Lossless** within a session, right-click the icon and click **Switch to pixel perfect** or use the shortcut ALT+SHIFT+1.
 - For lossless compression: HDX 3D Pro uses the lossless codec for compression regardless of the codec selected through policy.
 - For lossy compression: HDX 3D Pro uses the original codec, either the default or the one selected through policy.
- Lossless switch settings are not retained for subsequent sessions. To use a lossless codec for every connection, select **Always lossless** in the **Visual quality policy** setting.

You can override the default shortcut, ALT+SHIFT+1, to select or deselect Lossless within a session. Configure a new registry setting at [HKEY_LOCAL_MACHINE\SOFTWARE\Citrix\HDX3D\LLIndicator](#).

- Name: HKEY_LOCAL_MACHINE_HotKey, Type: String

| | | | | |
|---|--------|--------|--------|---|
| The format to
configure a
shortcut
combination is
C=0 | 1, A=0 | 1, S=0 | 1, W=0 | 1, K=val. Keys
must be comma
“,”separated. The
order of the keys
does not matter. |
|---|--------|--------|--------|---|

-
- A, C, S, W and K are keys, where C=Control, A=ALT, S=SHIFT, W=Win, and K=a valid key. Allowed values for K are 0–9, a–z, and any virtual key code.
- For example:
For F10, set K=0x79

For Ctrl + F10, set C=1, K=0x79

For Alt + A, set A=1, K=a or A=1, K=A or K=A, A=1

For Ctrl + Alt + 5, set C=1, A=1, K=5 or A=1, K=5, C=1

For Ctrl + Shift + F5, set A=1, S=1, K=0x74

Optimize the HDX 3D Pro user experience

When multiple users share a connection with limited bandwidth (for example, at a branch office), we recommend that you use the Overall session bandwidth limit policy setting to limit the bandwidth available to each user. Using this setting ensures that the available bandwidth does not fluctuate widely as users log on and off. Because HDX 3D Pro automatically adjusts to use all the available bandwidth, large variations in the available bandwidth throughout user sessions can negatively impact performance.

For example, if 20 users share a 60 Mbps connection, the bandwidth available to each user can vary between 3 Mbps and 60 Mbps, depending on the number of concurrent users. To optimize the user experience in this scenario, determine the bandwidth required per user at peak periods and limit users to this amount always.

For users of a 3D mouse, we recommend that you increase the priority of the Generic USB Redirection virtual channel to 0. For information about changing the virtual channel priority, see the Knowledge Center article CTX128190.

Use the HDX Monitor tool to validate the operation and configuration of HDX visualization technologies and to diagnose and troubleshoot HDX issues. The tool is available in the **Support** folder on the Citrix Virtual Apps and Desktops installation media.

GPU acceleration for Windows multi-session OS

December 7, 2023

Citrix Virtual Apps and Desktops support graphics-heavy applications running in Windows Multi-session OS sessions to render on the server's graphics processing unit (GPU). By moving OpenGL, DirectX, Direct3D, and Windows Presentation Foundation (WPF) rendering to the server's GPU, the server's CPU can be used more efficiently.

Since Windows Server is a multi-user operating system, multiple users can share a GPU accessed by Citrix Virtual Apps without the need for GPU virtualization (vGPU).

For procedures that involve editing the registry, use caution: Editing the registry incorrectly can cause serious problems that might require you to reinstall your operating system. Citrix cannot guarantee that problems resulting from the incorrect use of Registry Editor can be solved. Use Registry Editor at your own risk. Be sure to back up the registry before you edit it.

GPU sharing

GPU Sharing enables GPU hardware rendering of OpenGL and DirectX applications in remote desktop sessions. It has the following characteristics:

- Can be used on bare metal or virtual machines to increase application scalability and performance.
- Enables multiple concurrent sessions to share GPU resources (most users do not require the rendering performance of a dedicated GPU).
- Requires no special settings.

A GPU can be assigned to the Windows Server virtual machine in either full pass-through or virtual GPU (vGPU) modes following Hypervisor and GPU vendor requirements. Bare-metal deployments on physical Windows Server machines are also supported.

GPU Sharing does not depend on any specific graphics card.

- For virtual machines, select a graphics card that is compatible with the Hypervisor in use. For a XenServer hardware compatibility list, see [Hypervisor Hardware Compatibility List](#).
- When running on bare metal, it is recommended to have a single display adapter enabled by the operating system. If multiple GPUs are installed on the hardware, disable all but one of them using Device Manager.

Scalability using GPU Sharing depends on several factors:

- The applications being run
- The amount of video RAM they consume
- The graphics card's processing power

Some applications handle video RAM shortages better than others. If the hardware becomes overloaded, instability or a crash of the graphics card driver might occur. Limit the number of concurrent users to avoid such issues.

- Access to a high-performance video encoder for NVIDIA GPUs and Intel Iris Pro graphics processors. A policy setting (enabled by default) controls this feature and allows the use of hardware encoding for H.264 encoding (where available). If such hardware is not available, the VDA falls back to CPU-based encoding using the software video codec. For more information, see [Graphics policy settings](#).

To confirm that GPU acceleration is occurring, the Graphics Status Indicator can be used:

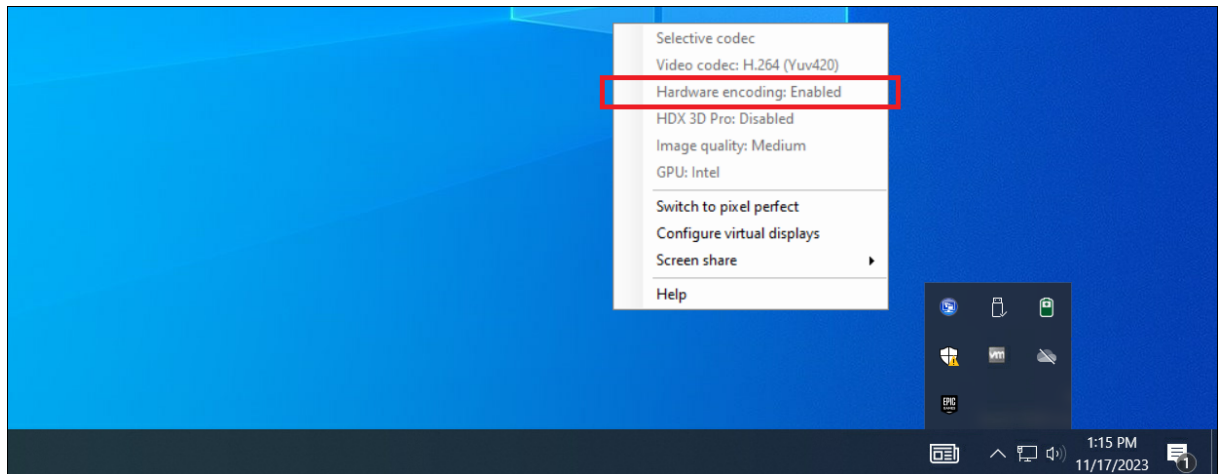

DirectX, Direct3D, and WPF rendering

DirectX, Direct3D, and WPF rendering are only available on servers with a GPU that supports a display driver interface (DDI) version of 9ex, 10, or 11.

- On Windows Server 2016 and later, Remote Desktop Services (RDS) sessions on the RD Session Host server use the Microsoft Basic Render Driver as the default adapter. To use the GPU in RDS sessions on Windows Server 2016 and later, enable the **Use the hardware default graphics adapter for all Remote Desktop Services sessions** setting in the group policy **Local Computer Policy > Computer Configuration > Administrative Templates > Windows Components > Remote Desktop Services > Remote Desktop Session Host > Remote Session Environment**.
- To enable WPF applications to render using the server's GPU, create the settings in the registry of the server running Windows Multi-session OS sessions. For information on the registry setting, see [Windows Presentation Foundation \(WPF\) rendering](#) in the list of features managed through the registry.

GPU acceleration for CUDA or OpenCL applications

GPU acceleration of CUDA and OpenCL applications running in a user session is disabled by default.

To use the CUDA acceleration features, enable the registry settings. For information, see [GPU acceleration for CUDA or OpenCL applications](#) in the list of features managed through the registry.

GPU acceleration for Windows single-session OS

March 20, 2024

With HDX 3D Pro, you can deliver graphically intensive applications as part of hosted desktops or applications on Single-session OS machines. HDX 3D Pro supports physical host computers (including desktop, blade, and rack workstations) and GPU Passthrough and GPU virtualization technologies offered by XenServer, vSphere, Nutanix, and Hyper-V (passthrough only) hypervisors.

HDX 3D Pro-offers the following features:

- Adaptive H.264-based or H.265-based deep compression for optimal WAN and wireless performance. HDX 3D Pro uses CPU-based full-screen H.264 compression as the default compression technique for encoding. Hardware encoding with H.264 is used with NVIDIA, Intel, and AMD cards that support NVENC. Hardware encoding with H.265 is used with NVIDIA cards that support NVENC.
- Lossless compression option for specialized use cases. HDX 3D Pro also offers a CPU-based lossless codec to support applications where pixel-perfect graphics are required, such as medical imaging. True lossless compression is recommended only for specialized use cases because it consumes more network and processing resources.

Caution:

Editing the registry incorrectly can cause serious problems that might require you to reinstall your operating system. Citrix cannot guarantee that problems resulting from the incorrect use of Registry Editor can be solved. Use Registry Editor at your own risk. Be sure to back up the registry before you edit it.

- Multiple and high-resolution monitor support. For Single-session OS machines, up to 8 4K monitors are supported. Users can arrange their monitors in any configuration and can mix monitors with different resolutions and orientations. The number of monitors is limited by the capabilities of the host computer GPU, the user device, and the available bandwidth. HDX 3D Pro supports all monitor resolutions and is limited only by the capabilities of the GPU on the host computer.
- Dynamic resolution. You can resize the virtual desktop or application window to any resolution. **Note:** The only supported method to change the resolution is by resizing the VDA session window. Changing resolution from within the VDA session (using **Control Panel > Appearance and Personalization > Display > Screen Resolution**) is not supported.
- Support for NVIDIA vGPU architecture. HDX 3D Pro supports NVIDIA vGPU cards. For information, see [NVIDIA vGPU](#) for GPU passthrough and GPU sharing. NVIDIA vGPU enables multiple VMs to have simultaneous, direct access to a single physical GPU, using the same NVIDIA graphics drivers that are deployed on non-virtualized operating systems.
- Support for VMware vSphere and VMware ESX using Virtual Direct Graphics Acceleration (vDGA)
 - You can use HDX 3D Pro with vDGA for both RDS and VDI workloads.
- Support for VMware vSphere/ESX.

- Support for Microsoft HyperV using Discrete Device Assignment in Windows Server 2016.
- Support for Data Center Graphics with Intel Xeon Processor E3 Family and Intel Data Center GPU Flex Series. For more information, see <https://www.intel.com/content/www/us/en/products/details/discrete-gpus/data-center-gpu/flex-series.html>.
- Support for AMD GPUs.

Note:

Support for AMD MxGPU (GPU virtualization) works with VMware vSphere vGPUs only. Citrix Hypervisor and Hyper-V are supported with GPU passthrough. For more information, see <https://www.amd.com/en/graphics/workstation-virtual-graphics>.

- Access to a high-performance video encoder for NVIDIA GPUs, AMD GPUs, and Intel GPUs. A policy setting (enabled by default) controls this feature. The feature allows the use of hardware encoding for H.264, H.265, or AV1 encoding (where available). If such hardware is not available, the VDA falls back to CPU-based encoding using the software video codec. For more information, see [Graphics policy settings](#).

As shown in the following figure:

- When a user logs in to Citrix Workspace app and accesses the virtual application or desktop, the Controller authenticates the user. The Controller then contacts the VDA for HDX 3D Pro to broker a connection to the computer hosting the graphical application.

The VDA for HDX 3D Pro uses the appropriate hardware on the host to compress views of the complete desktop or of just the graphical application.

- The desktop or application views and the user interactions with them are transmitted between the host computer and the user device. This transmission is done through a direct HDX connection between Citrix Workspace app and the VDA for HDX 3D Pro.

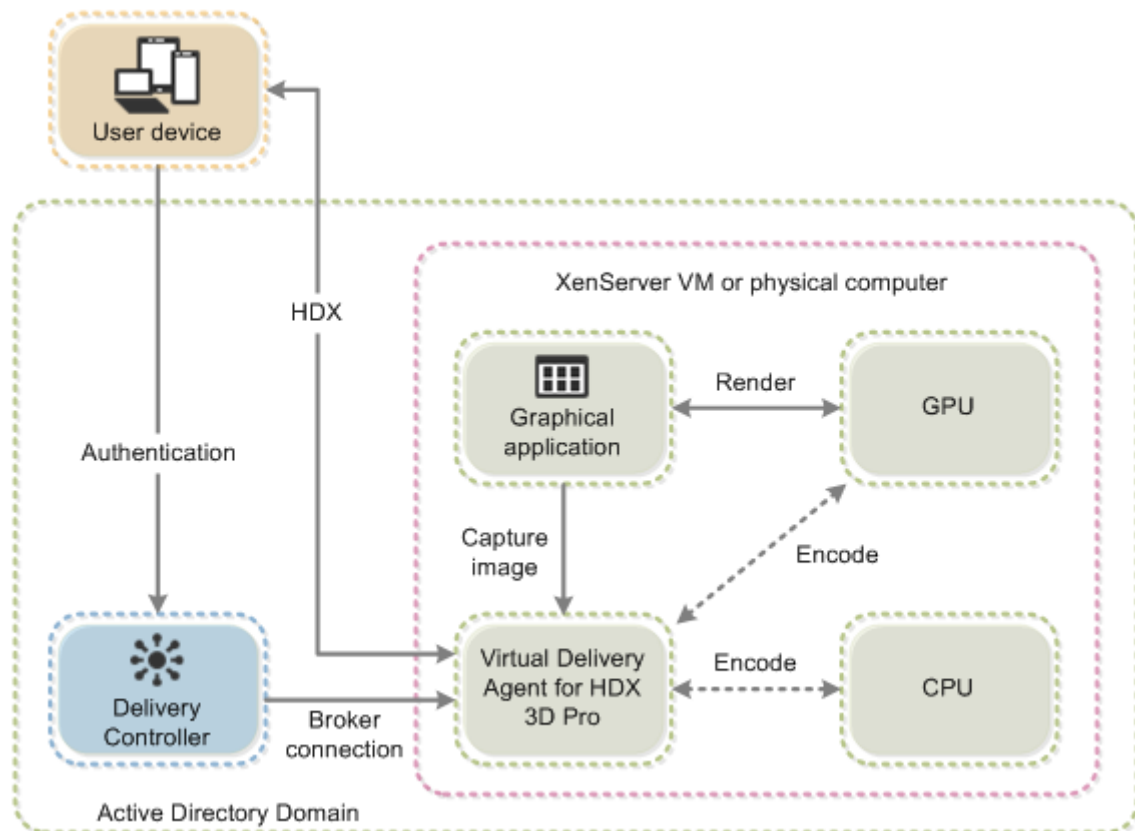

Optimize the HDX 3D Pro user experience

When multiple users share a connection with limited bandwidth (for example, at a branch office), we recommend that you use the **Overall session bandwidth limit** policy setting to limit the bandwidth available to each user. Using this setting ensures that the available bandwidth does not fluctuate widely as users log on and off. Because HDX 3D Pro automatically adjusts to use all the available bandwidth, large variations in the available bandwidth over the course of user sessions can negatively impact performance.

For example, if 20 users share a 60 Mbps connection, the bandwidth available to each user can vary between 3 Mbps and 60 Mbps, depending on the number of concurrent users. To optimize the user experience in this scenario, determine the bandwidth required per user at peak periods and limit users to this amount always.

For users of a 3D mouse, we recommend that you increase the priority of the Generic USB Redirection virtual channel to 0. For information about changing the virtual channel priority, see the Knowledge Center article [CTX128190](#).

Lossless compression

When using lossless compression:

- The lossless indicator, a notification area icon, notifies the user if the screen displayed is a lossy frame or a lossless frame. This icon helps when the **Visual Quality** policy setting specifies **Build to lossless**. The lossless indicator turns green when the frames sent are lossless.
- The lossless switch enables the user to change to **Always Lossless** mode anytime within the session. To select or deselect Lossless anytime within a session, right-click the icon and click **Switch to pixel perfect** or use the shortcut **ALT+SHIFT+1**.
- For lossless compression: HDX 3D Pro uses the lossless codec for compression regardless of the codec selected through policy.
- For lossy compression: HDX 3D Pro uses the original codec, either the default or the one selected through policy.
- Lossless switch settings are not retained for subsequent sessions. To use a lossless codec for every connection, select **Always lossless** in the **Visual quality** policy setting.

Lossless hotkey

You can use a hotkey to select or clear **Lossless** at any time within a session, by using the default shortcut **ALT+SHIFT+1**.

You can override the default shortcut, **ALT+SHIFT+1**, in the Windows Registry.

To configure a new Registry setting, set the following registry values:

- **Key:** `HKEY_CURRENT_USER\SOFTWARE\Citrix\Graphics`
- **Name:** `HKLM_HotKey`
- **Type:** `String`

The format to configure a shortcut combination is `C=0|1, A=0|1, S=0|1, W=0|1, K=val`. Keys must be comma “,” separated without a space. The order of the keys doesn’t matter.

A, C, S, W and K are keys, where C=Control, A=ALT, S=SHIFT, W=Win, and K=a valid key where allowed values for K are 0–9, a–z, and any virtual key code.

For example,

- For **F10**, set `K=0x79`
- For **Ctrl + F10**, set `C=1, K=0x79`
- For **Alt + A**, set `A=1, K=a` or `A=1, K=A` or `K=A, A=1`
- For **Ctrl + Alt + 5**, set `C=1, A=1, K=5` or `A=1, K=5, C=1`
- For **Ctrl + Shift + F5**, set `A=1, S=1, K=0x74`

The following table depicts the example list of virtual key codes:

| Key | Value |
|-----------------|-------|
| F1 | 0x70 |
| F2 | 0x71 |
| F3 | 0x72 |
| F4 | 0x73 |
| F5 | 0x74 |
| F6 | 0x75 |
| F7 | 0x76 |
| F8 | 0x77 |
| F9 | 0x78 |
| F10 | 0x79 |
| F11 | 0x7A |
| F12 | 0x7B |
| PAGE UP key | 0x21 |
| PAGE DOWN key | 0x22 |
| END key | 0x23 |
| HOME key | 0x24 |
| LEFT ARROW key | 0x25 |
| UP ARROW key | 0x26 |
| RIGHT ARROW key | 0x27 |
| DOWN ARROW key | 0x28 |

Ensure that there is no space between the shortcut combinations. For example:

Correct:

C=1,K=0x74

Incorrect:

C=1, K=0x74

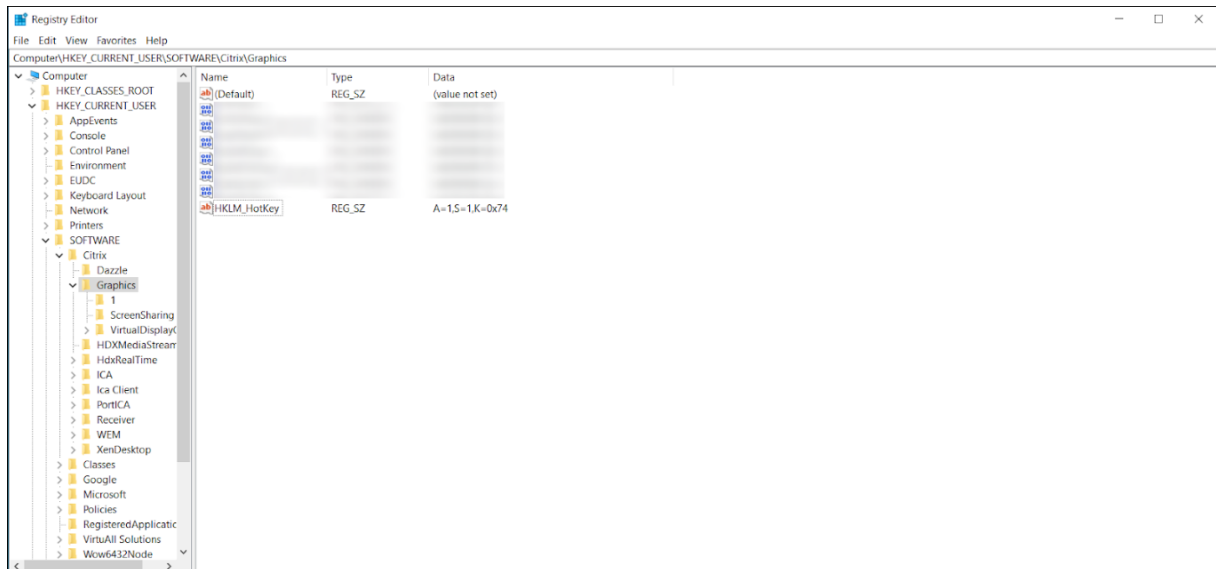

Caution:

Editing the registry incorrectly can cause serious problems that might require you to reinstall your operating system. Citrix cannot guarantee that problems resulting from the incorrect use of Registry Editor can be solved. Use Registry Editor at your own risk. Be sure to back up the registry before you edit it.

Thinwire

February 12, 2024

Introduction

Thinwire, a part of Citrix HDX technology, is the Citrix default display remoting technology used in Citrix Virtual Apps and Desktops.

Display remoting technology allows graphics generated on one machine to be transmitted, typically across a network, to another machine for display.

A successful display-remoting solution provides a highly interactive user experience that is similar to that of a local PC. Thinwire achieves this experience by using a range of complex and efficient image analysis and compression techniques. Thinwire maximizes server scalability and consumes less bandwidth than other display-remoting technologies.

Because of this balance, Thinwire meets most general business use cases and is used as the default display-remoting technology in Citrix Virtual Apps and Desktops.

HDX 3D Pro

In its default configuration, Thinwire can deliver 3D or highly interactive graphics and use a graphics processing unit (GPU), if present. However, we recommend enabling HDX 3D Pro mode using the **Optimize for 3D graphics workload** or **Visual quality > Build to lossless** policies for scenarios when GPUs are present. These policies configure Thinwire to use a video codec (H.264, H.265, or AV1) to encode the entire screen using hardware acceleration if a GPU is present. Doing so provides a more fluid experience for 3D professional graphics. For more information, see [H.264 Build to lossless](#), [HDX 3D Pro](#), and [GPU acceleration for Windows Single-session OS](#).

Requirements

Thinwire is optimized for modern operating systems, including Windows Server 2022, Windows Server 2019, Windows Server 2016, Windows Server 2012 R2, Windows 10, and Windows 7. For Windows Server 2008 R2, legacy graphics mode is recommended. Use the built-in [Citrix policy templates](#), High Server Scalability-Legacy OS and Optimized for WAN-Legacy OS to deliver the Citrix recommended combinations of the policy settings for these use cases.

- The policy setting that drives the behavior of Thinwire - **Use video codec for compression** is available on VDA versions in Citrix Virtual Apps and Desktops 7 1808 or later and XenApp and XenDesktop 7.6 FP3 and later. The **Use video codec when preferred** option is the default setting on VDA versions Citrix Virtual Apps and Desktops 7 1808 or later and XenApp and XenDesktop 7.9 and later.
- All Citrix Workspace apps support Thinwire. Some Citrix Workspace apps might support features of Thinwire that others do not, for example, 8-bit or 16-bit graphics for reduced bandwidth usage. Support for such features is automatically negotiated by the Citrix Workspace app.
- Thinwire uses more server resources (CPU, memory) in multi-monitor and high-resolution scenarios. It is possible to tune the amount of resources Thinwire uses, however, bandwidth usage might increase as a result.
- In low bandwidth or high latency scenarios, consider enabling 8-bit or 16-bit graphics to improve interactivity. Visual quality might be affected, especially at 8-bit color depth.

Encoding methods

Thinwire can operate in two different encoding modes depending on policy and client capabilities:

- Thinwire with Adaptive JPEG
Use video codec for compression policy setting: **Do not use video codec**

- Thinwire with Selective H.264, H.265, or AV1
Use video codec for compression policy setting: **Use video codec when preferred** or **For actively changing regions**
- Thinwire with Full Screen H.264, H.265 or AV1
Use video codec for compression policy setting: **For the entire screen**

H.265

High Efficiency Video Coding (HEVC), also known as H.265 is the successor to H.264. Hardware encoding with the H.265 video codec is supported on the following GPUs:

- NVIDIA Maxwell-based GPUs and upward
- Intel 6th generation GPUs and upward
- AMD Raven-based GPUs and upward

AV1

Citrix added support for the AV1 video codec. The benefit of AV1 is that it has superior image compression, better image quality, and lower bandwidth usage compared to H.264 and H.265.

The following requirements for AV1 must be met:

- VDA 2305 or higher for NVIDIA GPUS, or
- VDA 2308 or higher for Intel GPUs

The following GPUs are compatible for encoding:

- NVIDIA Ada Lovelace-based GPU
- Intel ARC or Intel Data Center GPU Flex Series GPUs

For more information about NVIDIA's Ada Lovelace GPUS, see [ADA architecture](#).

For more information about Intel's ARC workstation and data center Flex Series GPUs, see [Flex series](#) and [Overview](#).

Automatic video codec selection

You can automatically detect the best video codec to use when either the **Use video codec** for compression policy is enabled or Optimize for 3D graphics workload is enabled on the VDA. During installation of the Citrix Workspace app for Windows, the decoding capabilities of the endpoint are evaluated. Based on this information, the Citrix Workspace app for Windows negotiates the best codec to use with the VDA upon connection. The following list depicts the order in which the video codecs are evaluated:

- AV1
- H.265
- H.264

The automatic selection only applies to 4:2:0 variants of these codecs. If the **Visual Quality** setting is set to 'Build-to-Lossless' or 'Always Lossless' and when Allow Visually Lossless is set to 'enabled', automatic selection of the video codec is disabled.

When connecting to a resource, the Citrix Workspace app tests the endpoint's capability to decode H.265 and AV1 and save the capabilities in the registry. Citrix Workspace app then automatically selects the best video codec to use and negotiates this with the VDA. If both the VDA and the client can use H.265 and AV1, then AV1 is selected as the video codec. If AV1 is not available on either the VDA or on the client, H.265 is negotiated. If H.265 is also not available on either, the session uses H.264 as the video codec.

Note:

This feature is enabled by default. This behavior can be changed by setting the new client-side registry setting `DisableDecoderCaps`.

To disable the automatic selection of the video codec, set 'DisableDecoderCaps' as `HKLM\Software\WOW6432Node\Policies\Citrix\ICA Client\Graphics Engine DWORD DisableDecoderCaps = 1` or `HKCU\Software\Policies\Citrix\ICA Client\Graphics Engine DWORD DisableDecoderCaps = 1`.

If either of these values is set to 1, automatic selection of the video codec is not used. The graphics status indicator and the HDX monitor can monitor the video codec.

Configuration

Thinwire is the default display-remoting technology.

The following Graphics policy setting sets the default and provides alternatives for different use cases:

- [Use video codec for compression](#)
 - **Use video codec when preferred.** This is the default setting. No additional configuration is required. Keeping this setting as the default ensures that Thinwire is selected for all Citrix connections, and is optimized for scalability, bandwidth, and superior image quality for typical desktop workloads. This is functionally equivalent to **For actively changing regions**.
 - Other options in this policy setting continue to use Thinwire with other technologies for different use cases. For example:

- **For actively changing regions.** The adaptive display technology in Thinwire identifies moving images (video, 3D in motion) and uses H.264, H.265, or AV1 only in the part of the screen where the image is moving.
- **For the entire screen.** Delivers Thinwire with full-screen with H.264, H.265, or AV1 to optimize for improved user experience and bandwidth in cases with heavy use of 3D graphics. In the case of H.264 4:2:0 (the **Visually lossless** policy is disabled), the final image is not pixel perfect (lossless) and might not be suitable for certain scenarios. In such cases, consider using H.264 Build to lossless or H.265 Build to lossless instead.

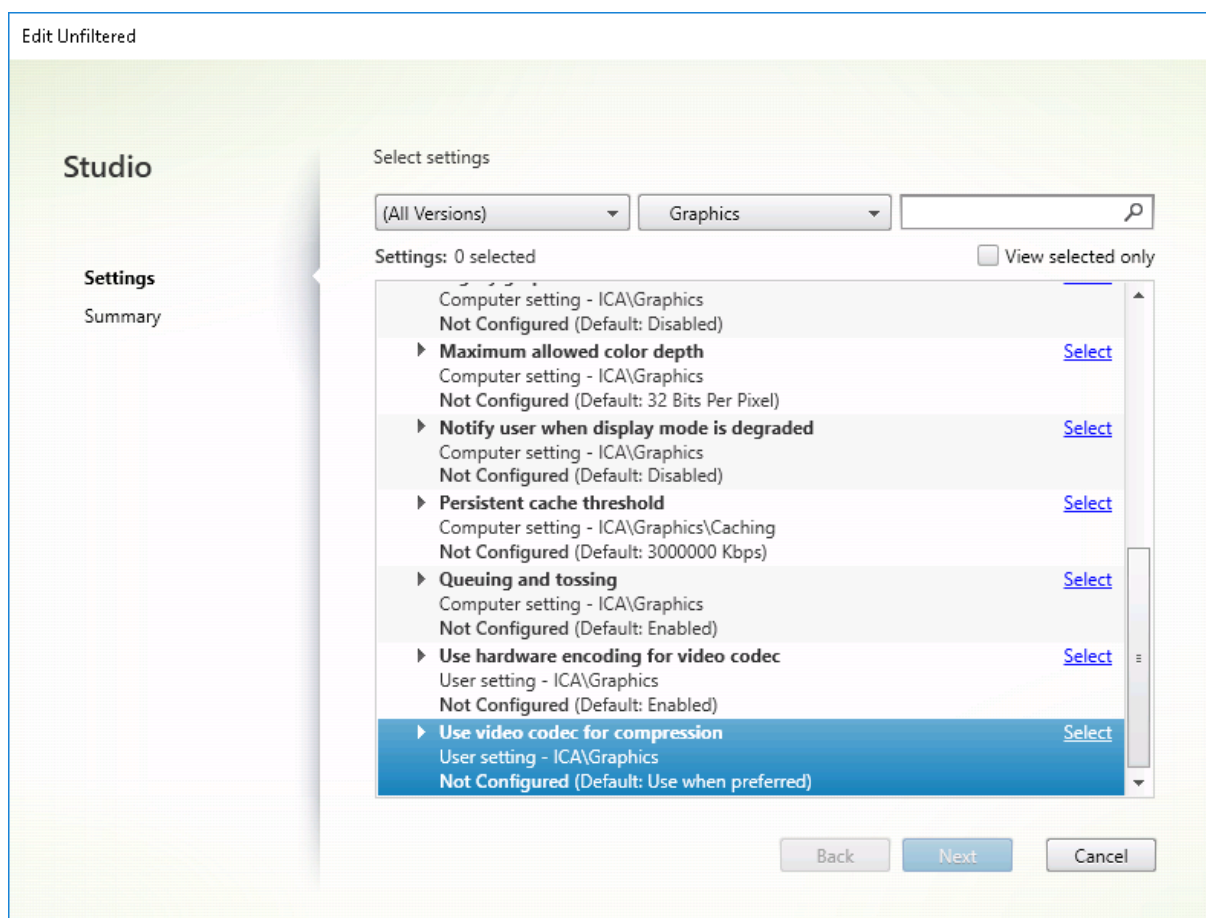

Various other policy settings, including the following Visual display policy settings, can be used to fine-tune the performance of display remoting technology. Thinwire supports them all.

- [Preferred color depth for simple graphics](#)
- [Target frame rate](#)
- [Visual quality](#)

To get the Citrix recommended combinations of policy settings for different business use cases, use the built-in [Citrix Policy templates](#). The **High Server Scalability** and **Very High Definition User Experience** templates use Thinwire with the optimum combinations of policy settings for your organization's priorities and your users' expectations.

Monitoring Thinwire

You can monitor the use and performance of Thinwire from Citrix Director. The HDX virtual channel details view contains useful information for troubleshooting and monitoring Thinwire in any session.

To view Thinwire-related metrics:

1. In Director, search for a user, machine or endpoint, open an active session and click **Details**. Or, you can select **Filters > Sessions > All Sessions**, open an active session and click **Details**.
2. Scroll down to the **HDX** panel.

The screenshot shows the HDX panel with a 'Download System Report' button and a list of virtual channels. Each row includes an icon, a name, and status details.

| Icon | Name | Status/Details |
|--|----------------------|--|
| Red exclamation mark, Adobe Flash | Adobe® Flash® | Virtual channel: Idle
Flash redirection: Inactive |
| Red exclamation mark, Graphics - Framehawk | Graphics - Framehawk | Virtual channel: Idle
Current FPS: 0 |
| Red exclamation mark, Scanner | Scanner | Virtual channel: Idle
Compression level: Medium |
| Red exclamation mark, Smart Cards | Smart Cards | Virtual channel: Idle
Number of devices: 0 |
| Yellow triangle, Legacy Graphics | Legacy Graphics | Virtual channel: Active
Still image compression: Medium |
| Green checkmark, Audio | Audio | Virtual channel: Idle
Number of devices: 1 |
| Green checkmark, HDX Graphics - Thinwire | Graphics - Thinwire | Virtual channel: Active
Current FPS: 1 |
| Green checkmark, Mapped Client Drives | Mapped Client Drives | Virtual channel: Idle
Client drives available: 0 |
| Green checkmark, Network | Network | Bandwidth used: 0%
Average latency: 47 ms |
| Green checkmark, Printing | Printing | Mapped printers: 4
Virtual channel: Idle |
| Green checkmark, VDA | VDA | Version:
Session ID: 3 |
| Green checkmark, Windows Media | Windows Media | Virtual channel: Idle
Active streams: 2 |

3. Select **Graphics - Thinwire**.

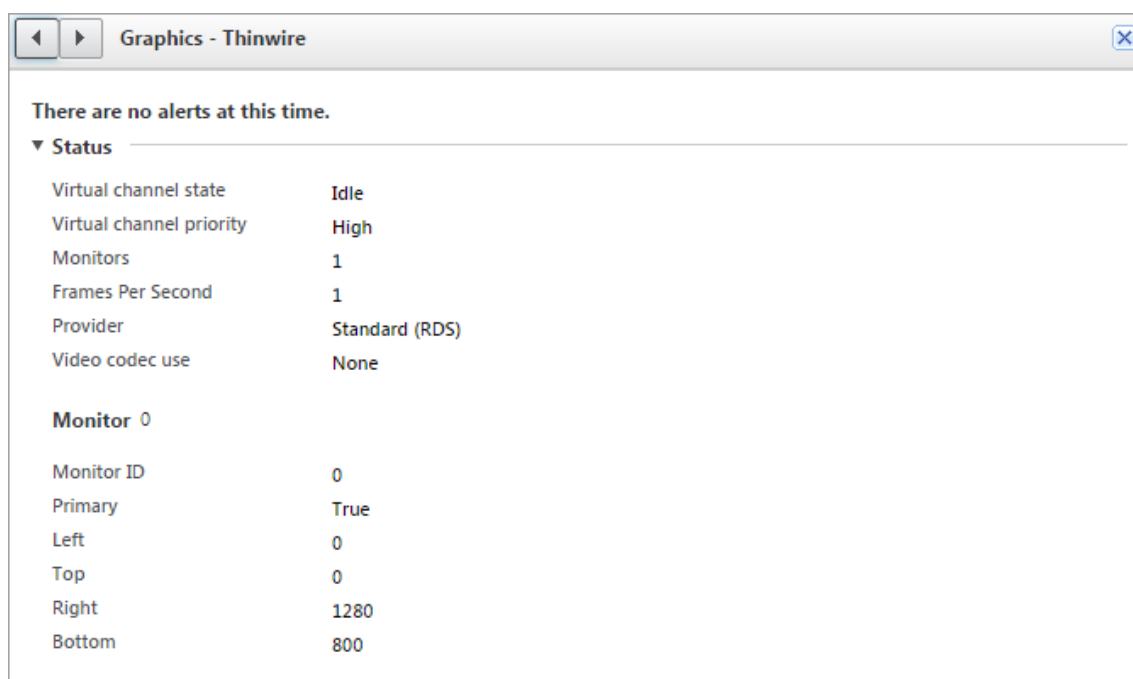

Lossless compression codec (MDRLE)

In a typical desktop session, most of the imagery is simple graphics or text regions. Thinwire determines where these regions are and selects these areas for lossless encoding using the 2DRLE codec. At the Citrix Workspace app client side, these elements are decoded using the Citrix Workspace app-side 2DRLE decoder for session display.

In XenApp and XenDesktop 7.17, we added a higher compression ratio MDRLE codec that consumes less bandwidth in typical desktop sessions than the 2DRLE codec. This new codec does not impact server scalability.

Lower bandwidth usually means improved session interactivity (especially on shared or constrained links) and reduced costs.

Configuration isn't required for the MDRLE codec. If Citrix Workspace app supports MDRLE decoding, the VDA uses the VDA MDRLE encoding and the Citrix Workspace app MDRLE decoding. If Citrix Workspace app doesn't support MDRLE decoding, the VDA automatically falls back to 2DRLE encoding.

MDRLE Requirements:

- Citrix Virtual Apps and Desktops minimum version 7 1808 VDAs
- XenApp and XenDesktop minimum version 7.17 VDAs
- Citrix Workspace app for Windows minimum version 1808
- Citrix Receiver for Windows minimum version 4.11

Progressive Mode

Citrix Virtual Apps and Desktops 1808 introduced progressive mode and enabled it by default. In constrained network conditions (default: bandwidth < 2 Mbps, or latency > 200 ms), Thinwire increased the compression of text and static imagery to improve interactivity during screen activity. The heavily compressed text and images are then progressively sharpened, in a random block fashion, when screen activity stops. While compressing and sharpening this way improves overall interactivity, it reduces cache efficiency and increases bandwidth usage.

As of Citrix Virtual Apps and Desktops 1906, progressive mode is disabled by default. We now use a different approach. The quality of still images is now based on network conditions and floats between a pre-defined minimum and maximum value for each **Visual quality** setting. Because there is no explicit sharpening step, Thinwire optimizes image delivery and maintains cache efficiency, while providing nearly all of the benefits of progressive mode.

Changing progressive mode behavior

You can change the progressive mode state with the registry key. For information, see [Progressive mode](#) in the list of features managed through the registry.

Build to lossless

Build to lossless is a special Thinwire configuration that optimizes graphics delivery for interactivity and final image quality. You can enable this setting by setting the **Visual quality** policy to **Build to lossless**.

Build to lossless compresses the screen using H.264, H.265, or AV1 during screen activity and sharpens to pixel perfect (lossless) when activity stops. The lossy image quality adapts to available resources to maintain the best possible frame rate. The sharpening step is performed gradually. For example, selecting a model and rotating it.

Build to lossless offers all the advantages of using a video codec for the entire screen, including hardware acceleration, but with the added benefit of a final, guaranteed lossless screen. This is critical for 3D-type workloads that require a final pixel-perfect image. For example, manipulating medical imagery. Also, H.264 **Build to lossless** uses fewer resources than full-screen H.264 4:4:4. As a result, using **Build to lossless** usually results in a higher frame rate than Visually lossless H.264 4:4:4.

Note:

You can disable the use of a video codec when using a build to lossless. Simply set the **Use video codec** policy to **Do not use video codec**. This results in moving images being encoded with Adaptive JPEG instead.

Visually lossless encoding

Visually Lossless encoding uses the YUV 4:4:4 color space instead of the chroma-subsampled YUV 4:2:0 color space for video codec compression. This ensures that no color information is lost during color space conversion, and once decoded, is visually imperceptible from the original RGB image.

Consider the following example. If using a video codec to compress the entire screen, 4:2:0 color compression can degrade high-contrast details like text, making them fuzzy and harder to read. In contrast, 4:4:4 preserves nearly all color information and does not exhibit any visually perceptible degradation.



Workloads that require pixel perfect quality or accurate color display can benefit from Visually Lossless encoding.

Visually Lossless encoding is available with both H.264 and H.265. H.264 4:4:4 encoding is a purely software-based solution, and as a result, there may be a significant impact on CPU utilization on both the VDA and the client. This may also affect the frame rate.

H.265 4:4:4 support was added with the release of Citrix Workspace app 2305, enabling Thinwire to use both a GPU on the VDA and client for H.265 4:4:4 encoding, significantly improving performance.

To allow Visually Lossless 4:4:4 encoding, two policies need to be enabled:

- **Visual Quality:** Set to `Build to Lossless` or `Always Lossless`
- **Allow Visually Lossless:** Set to `Enabled`

Note:

If **Allow Visually Lossless** is not enabled, we switch to our Thinwire encoder in either `Build to lossless` or `Always Lossless`.

H.265 4:4:4 visually lossless has the additional requirements:

- NVIDIA GPUs require VDA version 2209 or higher
- Intel GPUs require VDA version 2308 or higher

The following GPUs are supported for H.265 4:4:4:

- NVIDIA Pascal-generation GPUs and onward
- Intel 10th generation GPUs and onward

For the client, Citrix Workspace app for Windows version 2305 is required (version 2309.1 is recommended).

Hardware decoding of H.265 4:4:4 is possible with the following client device GPUs:

- NVIDIA Turing-generation GPUs and onward
- Intel 10th generation GPUs and onward

Text-based session watermark

December 7, 2020

Text-based session watermarks help to deter and enable tracking data theft. This traceable information appears on the session desktop as a deterrent to those using photographs and screen captures to steal data. You can specify a watermark that is a layer of text, which displays over the entire session screen without changing the content of the original document. Text-based session watermarks require VDA support.

Important:

Text-based session watermarking is not a security feature. The solution does not prevent data theft completely, but it provides some level of deterrent and traceability. Although we do not guarantee complete information traceability when using this feature, we recommend that you combine this feature with other security solutions as applicable.

The session watermark is text and is applied to the session that is delivered to the user. The session watermark carries information for tracking data theft. The most important data is the identity of the logon user of the current session in which the screen image was taken. To trace the data leakage more effectively, include other information such as server or client internet protocol address and a connect time.

To adjust the user experience, use the [Session Watermark policy settings](#) to configure the placement and watermark appearance on the screen.

Requirements:

Virtual Delivery Agents:

Multi-session OS 7.17

Single-session OS 7.17

Limitations:

- Session watermarks are not supported in sessions where Local App Access, Windows media redirection, MediaStream, browser content redirection, and HTML5 video redirection are used. To use session watermark, ensure that these features are disabled.
- Session watermark is not supported and doesn't appear if the session is running in full-screen hardware accelerated modes (full-screen H.264 or H.265 encoding).
- If you set these HDX policies, watermark settings don't take effect and a watermark isn't displayed in the session display.

Use hardware encoding for video codec to Enabled

Use video codec for compression to For the entire screen

- If you set these HDX policies, the behavior is undetermined and the watermark might not display.

Use hardware encoding for video codec to Enabled

Use video codec for compression to Use video codec when preferred

To ensure the watermark displays, set **Use hardware encoding for video codec** to **Disabled**, or set **Use video codec for compression** to **For actively changing regions** or **Do not use video codec**.

- Session watermark supports only the Thinwire graphics mode.
- If you use Session Recording, the recorded session doesn't include the watermark.
- If you use Windows remote assistance, the watermark is not shown.
- If a user presses the **Print Screen** key to capture the screen, the screen captured at the VDA side doesn't include the watermarks. We recommend that you take measures to avoid the captured image being copied.

Screen sharing

February 10, 2022

Screen sharing allows a user to share a Citrix Virtual Desktop session with others including screen contents, keyboard, and mouse controls.

System requirements

- Windows: Single-session or multi-session OS VDA
- Linux: See the [Linux VDA documentation](#) for more information on sharing Linux sessions.

- Only desktop sessions can be shared.
- There must be network connectivity between the VDA hosting the session and the machines connecting to the shared sessions. Network port requirements are based on ICA ports in use (TCP/UDP 1494 or 2598) and the [Screen sharing policy](#) configuration (TCP 52525 to 52625 by default).

Configuration

Screen sharing must be enabled using Citrix policies. Screen sharing is disabled by default. Configure the [screen sharing policy](#) to enable or disable the function and assign the usable network port range.

Enable the [graphics status indicator](#) policy to display the user interface that includes controls for sharing and connecting to sessions.

Sharing a session

To share a session, look for the HDX graphics status indicator icon on the Windows notification area. Right-click on it to display the menu and select **Screen share > Share my screen**.

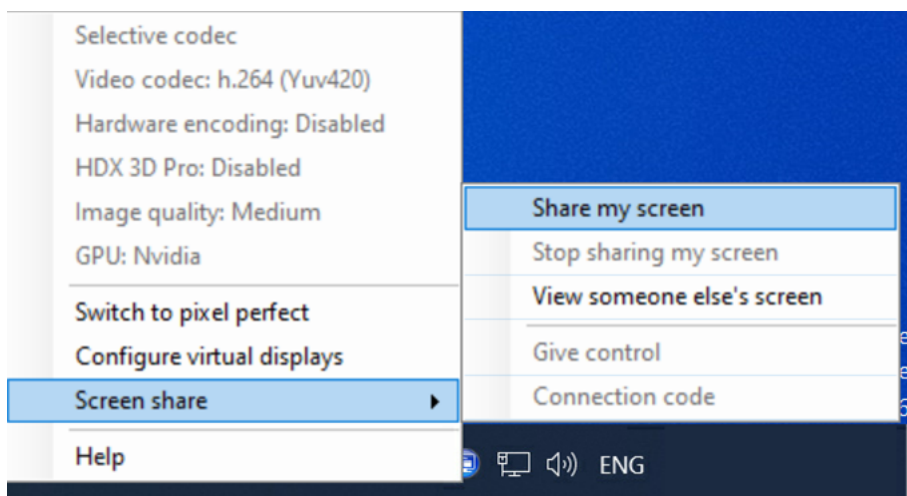

Click **Copy to clipboard** or manually select and copy the entire string shown in the dialog box. The string can then be pasted into the application of choice, such as an email or IM client, to be distributed to other users.

Click **OK** or the **x** to close the dialog box. The connection code can be retrieved from the **Screen share > Connection code** menu option at any time while the session is shared.

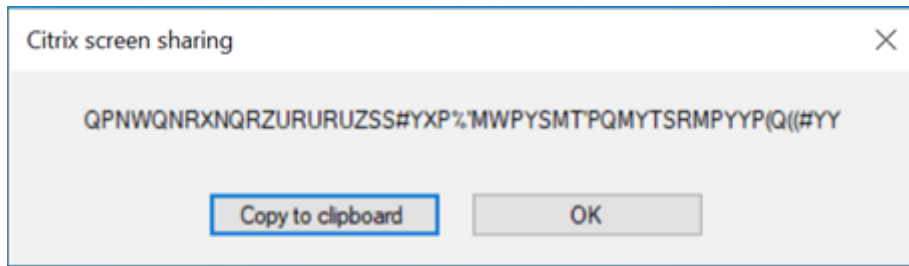

A red outline appears around the screen as an indicator that the session is now being shared and is visible by others.

Keyboard and mouse controls can also be shared with other users using the **Screen share > Give control** menu option.

Use the **Screen share > Stop sharing my screen** menu option to stop sharing the session and disconnect all users.

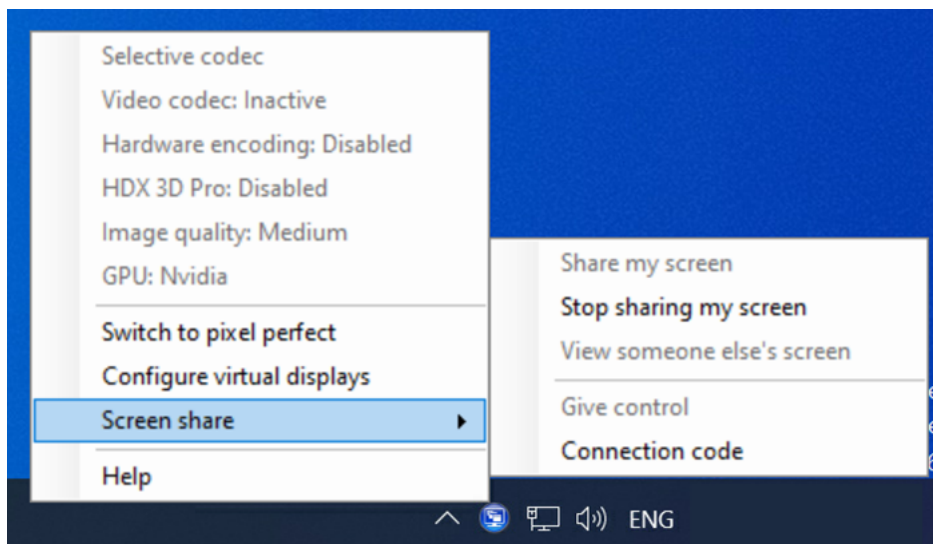

Connecting to a shared session

To connect to someone else's sessions, look for the HDX graphics status indicator icon on the Windows notification area. Right-click on it to display the menu and select **Screen share > View someone else's screen**.

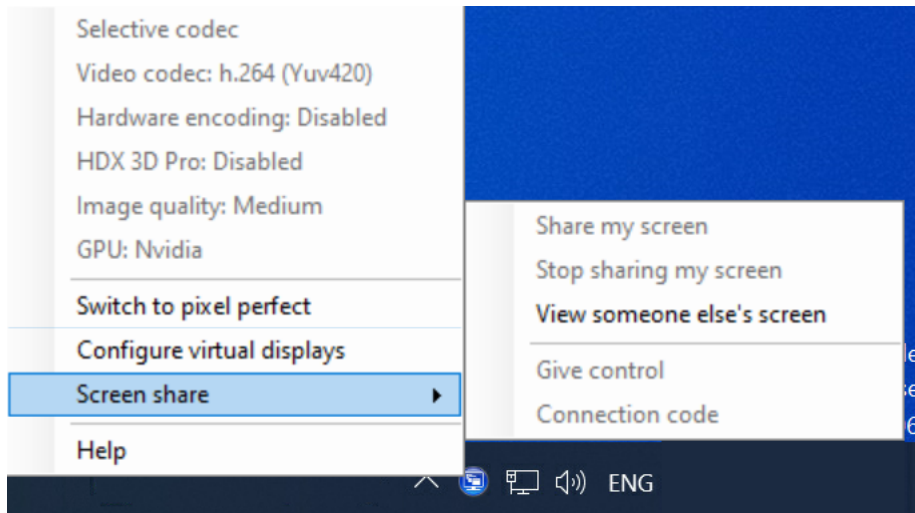

Enter or paste the connection string that was provided by the user sharing the session into the text box. Click **Connect** to establish the connection.

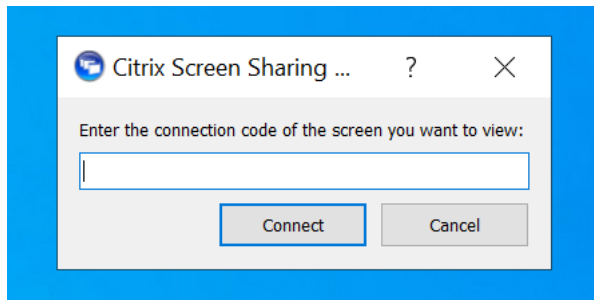

You can request keyboard and mouse controls by clicking the mouse icon on the top left corner of the **HDX Screen Sharing Viewer** window.

Close the **HDX Screen sharing Viewer** window to disconnect from the shared session at any time.

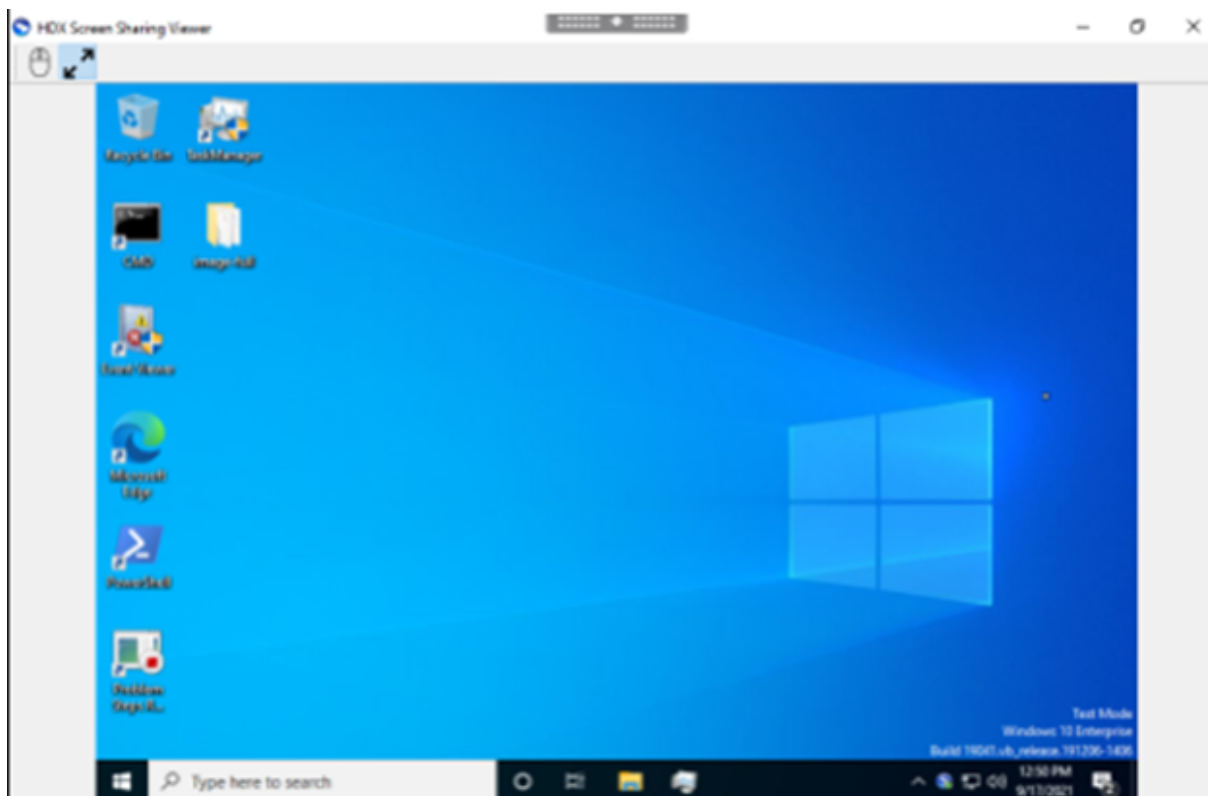

Other considerations

- The screen sharing viewer application is included with the VDA in `C:\Program Files\Citrix\HDX\bin\TwPlayer.exe` and might be deployed as a [published application](#) using a Virtual Apps Server. This alternative deployment model allows collaboration with users that don't have access to a virtual desktop.
- The number of users allowed to connect to a shared session can be limited using the network port range in the screen sharing policy. One port is required per user. The default range allows 100 users at most.
- All monitors connected to the session are shared. You cannot select individual monitors.
- The H.265 video codec isn't supported.

Virtual display layout

November 17, 2022

The virtual display configuration UI lets you define a virtual display layout per session monitor on the VDA, inside a live session. This feature allows you to split each session monitor independently into multiple virtual monitors. You can split into a total of 8 virtual monitors on the remote desktop. Also, you can update the session primary monitor and DPI settings for the displays.

The virtual display configuration is stored per user per client device. The configuration applies to all subsequent connections from a given client for a particular user. It's persisted across session resize, session disconnect or reconnect, and session logoff or logon. The configured virtual display layout reset occurs on a session resize and change in the number of session monitors.

System requirements

- Windows: Single-session or multi-session OS VDA
- [Graphics status indicator](#) policy must be enabled
- Only desktop sessions can be configured.

Configuration

To configure the virtual display layout, right-click the graphics status indicator icon and select the Configure virtual displays option. The virtual display configuration UI is launched.

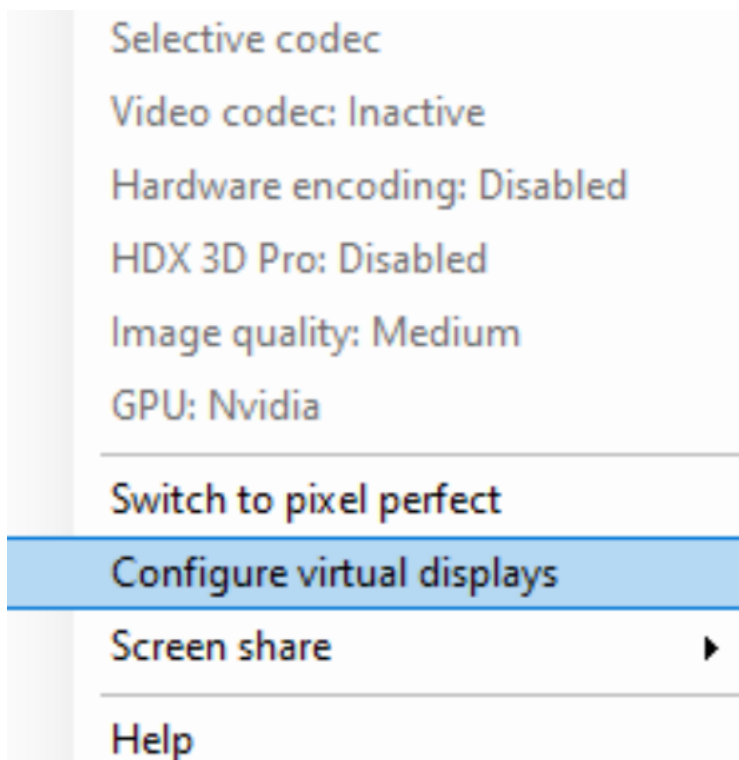

The UI shows the current session display layout, with blue denoting the session's primary monitor. You can see the Display settings tooltip when you hover on a display. The tooltip provides information about the current virtual display layout defined on a given session monitor.

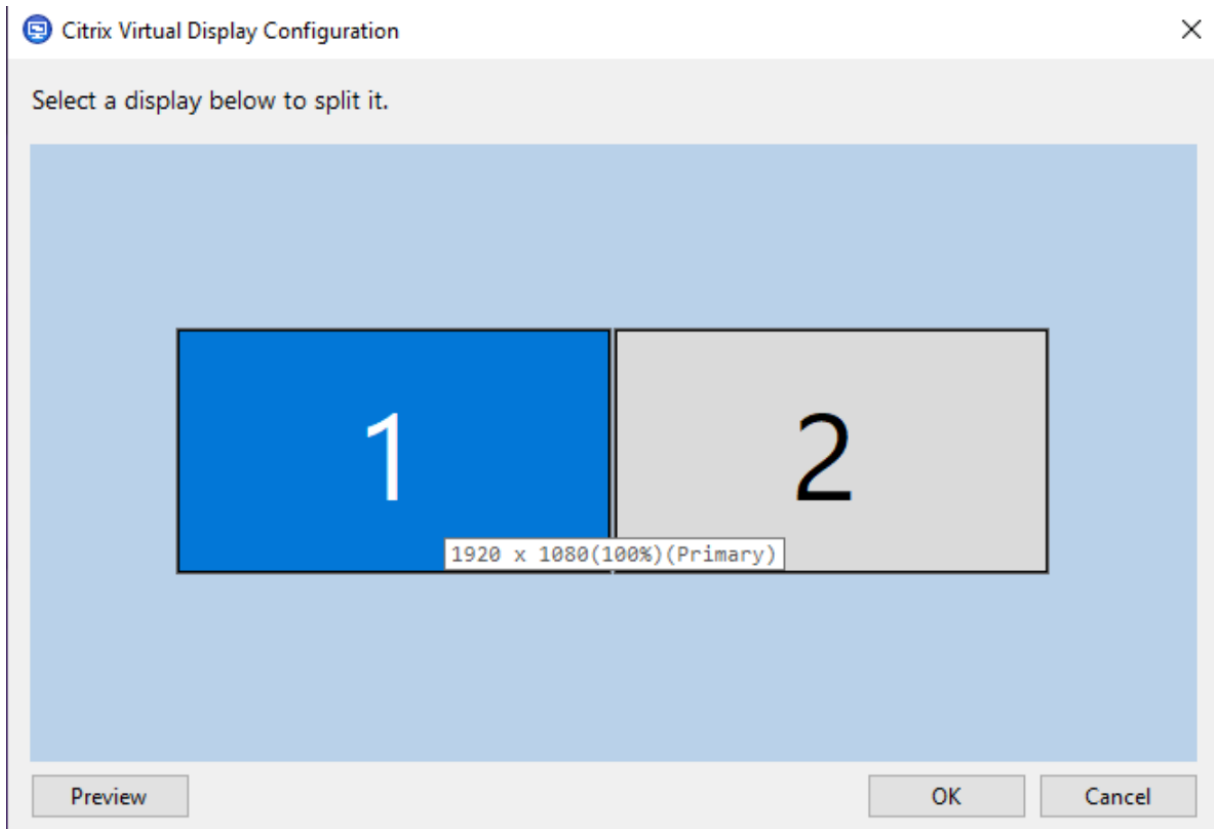

Select a display to transition to an interactive UI, which allows you to configure virtual displays for the selected session monitor. You can draw horizontal or vertical lines to separate the screen into virtual monitors. The screen is split according to specified percentages of the session monitor resolutions. Right-click on a virtual display to mark it as the primary monitor and use the DPI drop-down list to set a preferred scaling factor for the virtual display. After defining a virtual display layout, click **OK** to temporarily save the layout or **Cancel** to discard any changes. You can use **Reset** to undo the configuration and restore the original layout for the session monitor.

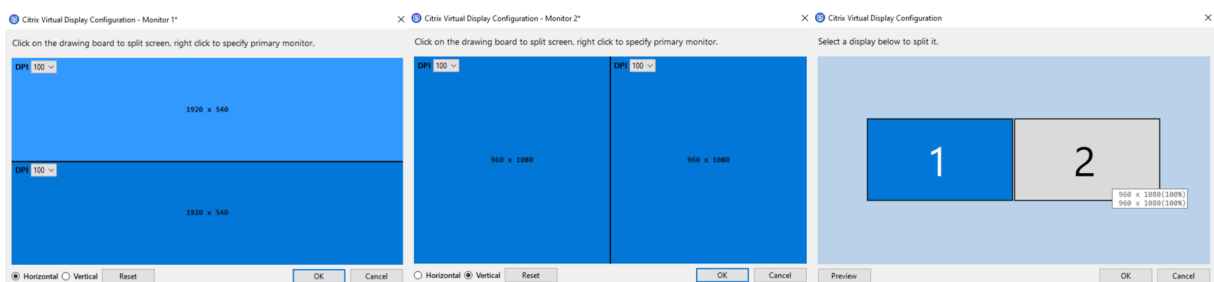

To preview the current configured virtual display layout, click the **Preview** button. A window appears to highlight the expected position and resolution of the virtual displays in the session.

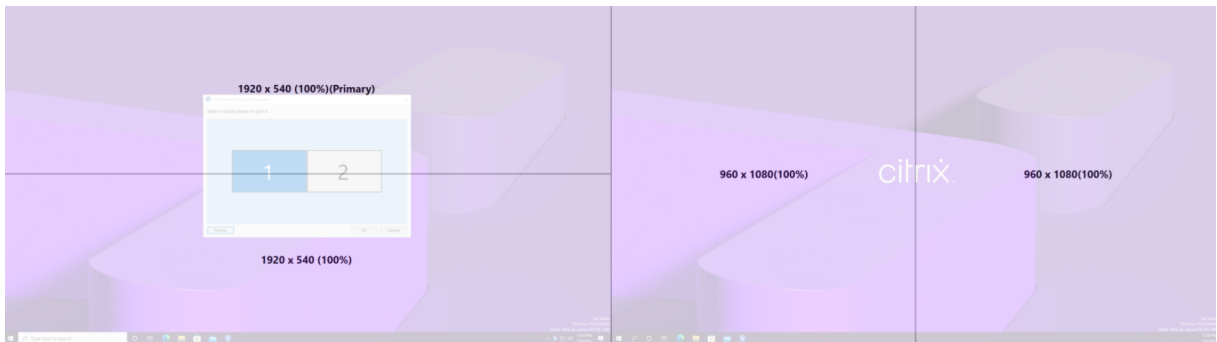

Click **OK** to immediately apply and save the virtual display layout. Click **Cancel** to close the UI and discard all changes.

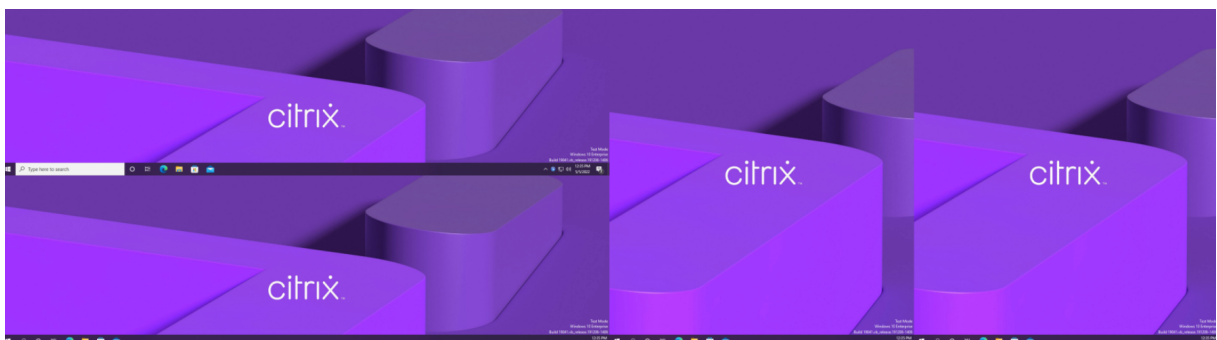

Other considerations

- The minimum virtual display resolution required is 640 x 480.
- Virtual display DPI defined through the UI depends on OS scaling support for the given display resolution.
- Do not use this feature simultaneously with the existing virtual display feature in Citrix Workspace app.
- Preview functionality isn't supported on Server 2016.

Adaptive Refresh Rate

December 7, 2023

With the new scalability improvements, HDX matches the refresh rate of virtual monitors to match the target FPS policy set. Adaptive Refresh Rate (ARR) is available for both single and multisession VDAs, and works for both GPU-accelerated and non-GPU scenarios.

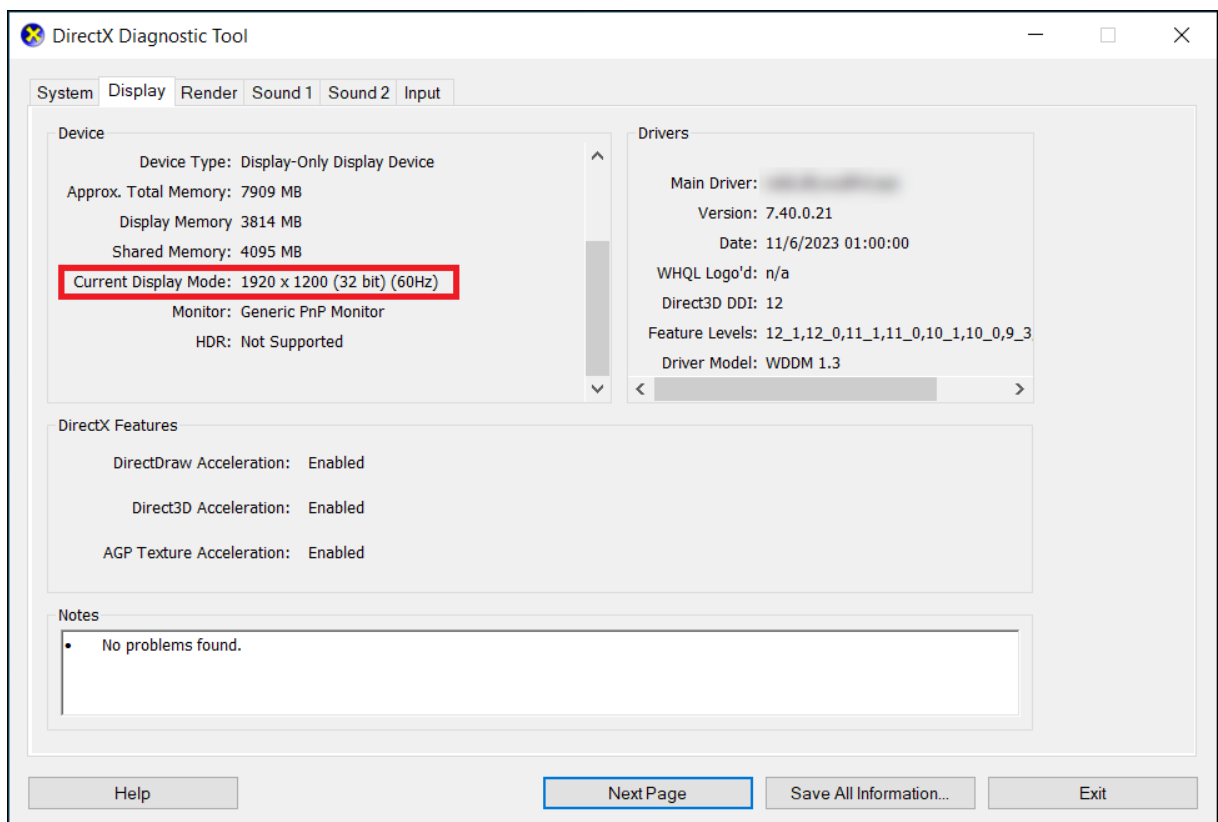
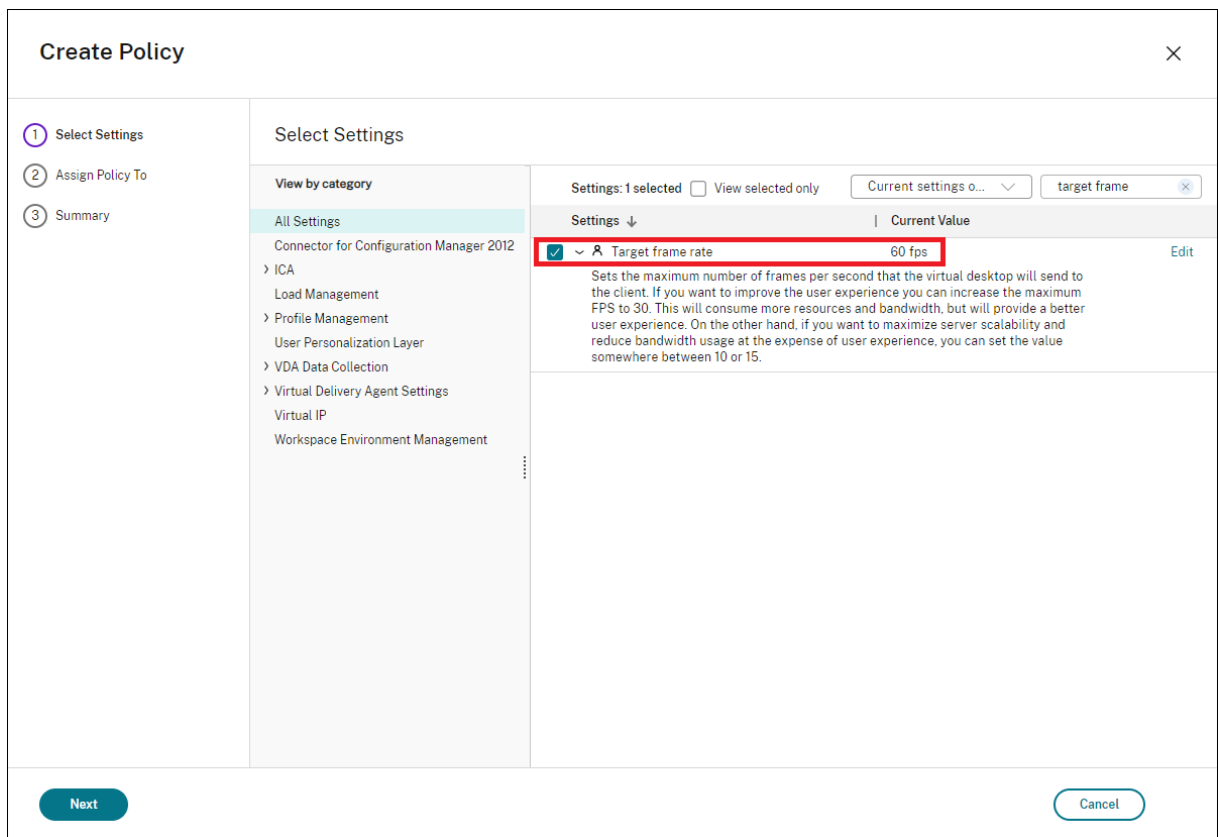

Note

Adaptive Refresh Rate is only available when Citrix Indirect Display or IDD is used (as per Citrix Virtual Apps and Desktops default) and is not available when using Vendor supplied Display Adapters.

Loss tolerant mode for graphics

December 18, 2023

The loss tolerant mode for graphics is thoroughly reworked to ensure the session remains interactive when packet loss is detected. When network conditions degrade beyond pre-defined bandwidth, latency, and packet loss thresholds, the Citrix graphics encoder automatically switches into a more aggressive mode of packet delivery to overcome the effect of packet loss. As a result, bandwidth usage increases by an amount proportional to the amount of packet loss. If conditions later improve, the Citrix graphics encoder seamlessly switches back. The thresholds can be configured via policy, with the defaults being 300 ms latency and 5% packet loss.

Citrix Workspace app for Windows 2311 is currently supported. Support for other platforms will be added in later Citrix Workspace app releases. As with previous versions of this feature, HDX Adaptive Transport (EDT) must be enabled for this feature to work. In addition, if connecting via the Citrix Gateway Service, loss tolerant mode for graphics must also be enabled on the Gateway.

Multimedia

January 10, 2020

The HDX technology stack supports the delivery of multimedia applications through two complementary approaches:

- Server-side rendering multimedia delivery
- Client-side rendering multimedia redirection

This strategy ensures that you can deliver a full range of multimedia formats, with a great user experience, while maximizing server scalability to reduce the cost-per-user.

With server-rendered multimedia delivery, audio and video content is decoded and rendered on the Citrix Virtual Apps and Desktops server by the application. The content is then compressed and delivered using ICA protocol to Citrix Workspace app on the user device. This method provides the highest rate of compatibility with various applications and media formats. Because video processing is

compute-intensive, server-rendered multimedia delivery benefits greatly from the onboard hardware acceleration. For example, support for DirectX Video Acceleration (DXVA) offloads the CPU by performing H.264 decoding in separate hardware. Intel Quick Sync, AMD RapidFire, and NVIDIA NVENC technologies provide hardware-accelerated H.264 encoding.

Because most servers do not offer any hardware acceleration for video compression, server scalability is negatively impacted if all video processing is done on the server CPU. You can maintain high server scalability, by redirecting many multimedia formats to the user device for local rendering.

- Windows Media redirection offloads the server for a wide variety of media formats typically associated with the Windows Media Player.
- HTML5 video has become popular, and Citrix introduced a redirection technology for this type of content. We recommend the browser content redirection for websites using HTML5, HLS, DASH, or WebRTC.
- You can apply the general content redirection technologies Host-to-client redirection and Local App Access to the multimedia content.

Putting these technologies together, if you don't configure redirection, HDX does Server-Side Rendering.

If you configure redirection, HDX uses either Server Fetch and Client Render or Client Fetch and Client Render. If those methods fail, HDX falls back to Server-Side Rendering as needed and is subject to the Fallback Prevention Policy.

Example scenarios

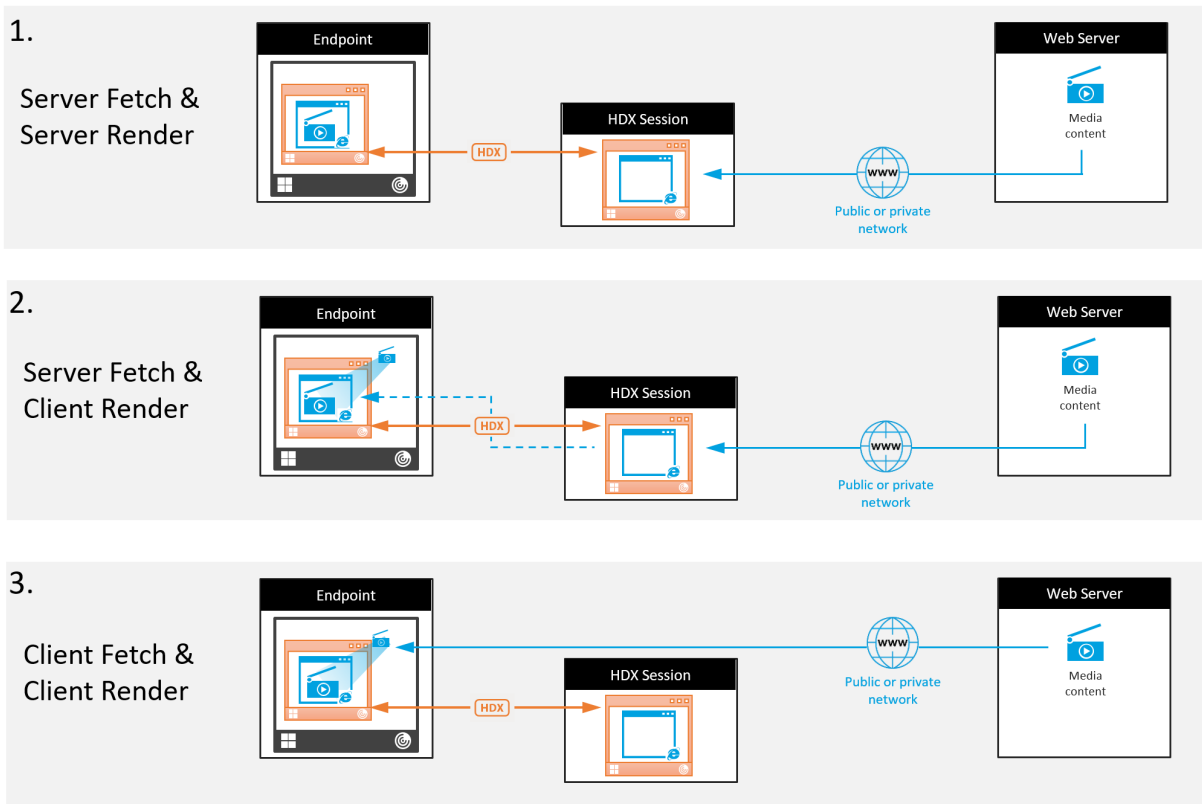

Scenario 1. (Server Fetch and Server Rendering):

1. The server fetches the media file from its source, decodes, and then presents the content to an audio device or display device.
2. The server extracts the presented image or sound from the display device or audio device respectively.
3. The server optionally compresses it, and then transmits it to the client.

This approach incurs a high CPU cost, high bandwidth cost (if the extracted image/sound isn't compressed efficiently), and has low server scalability.

Thinwire and Audio virtual channels handle this approach. The advantage of this approach is that it reduces the hardware and software requirements for the clients. Using this approach the decoding happens on the server and it works for a wider variety of devices and formats.

Scenario 2. (Server Fetch and Client Render):

This approach relies on being able to intercept the media content before it is decoded and presented to the audio or display device. The compressed audio/video content is instead sent to the client where it is then decoded and presented locally. The advantage of this approach is that the are offloaded to the client devices, saving CPU cycles on the server.

However, it also introduces some additional hardware and software requirements for the client. The client must be able to decode each format that it might receive.

Scenario 3. (Client Fetching and Client Rendering):

This approach relies on being able to intercept the media content URL before it's fetched from the source. The URL is sent to the client where the media content is fetched, decoded, and presented locally. This approach is conceptually simple. Its advantage is that it saves both CPU cycles on the server and bandwidth because the server sends only control commands. However, the media content is not always accessible to the clients.

Framework and platform:

Single-session operating systems (Windows, Mac OS X, and Linux) provide multimedia frameworks that enable the faster development of multimedia applications. This table lists some of the more popular multimedia frameworks. Each framework divides media processing into several stages and uses a pipelined-based architecture.

| Framework | Platform |
|------------------|---------------------------|
| DirectShow | Windows (98 and later) |
| Media Foundation | Windows (Vista and later) |
| Gstreamer | Linux |
| Quicktime | Mac OS X |

Double hop support with media redirection technologies

| | |
|-----------------------------|-----|
| Audio redirection | No |
| Browser content redirection | No |
| HDX webcam redirection | Yes |
| HTML5 Video redirection | Yes |
| Windows Media redirection | Yes |

Audio features

February 19, 2024

You can configure and add the following Citrix policy settings to a policy that optimizes HDX audio features. For usage details plus relationships and dependencies with other policy settings, see [Audio policy settings](#) and [Bandwidth policy settings](#) and [Multi-stream connections policy settings](#).

Adaptive audio

With adaptive audio, you don't need to manually configure the audio quality policies on the VDA. Adaptive audio optimizes settings for your environment and replaces obsolete audio compression formats to provide an excellent user experience.

Adaptive audio is enabled by default. To disable adaptive audio, see [Audio policy settings](#).

Important:

We recommend delivering audio using User Datagram Protocol (UDP) rather than TCP when real-time audio applications are required. Only Windows Virtual Delivery Agent (VDA) supports audio over UDP.

UDP audio encryption using DTLS is available only between Citrix Gateway and Citrix Workspace app. Therefore, sometimes it might be preferable to use TCP transport. TCP supports end-to-end TLS encryption from the VDA to Citrix Workspace app.

For more information on adaptive audio and UDP audio, see [Audio over UDP Real-time Transport and audio UDP port range](#).

Support for audio over loss tolerant mode (Preview)

The loss tolerant mode supports audio. This feature increases the user experience for real-time streaming and improves audio quality compared to EDT when users are connecting through networks with high latency and packet loss.

Public preview

This feature is disabled by default in 2308. To participate in the public preview, fill the [Loss Tolerant mode for Audio preview form](#).

System requirements

Ensure that the following products are on the minimum versions that support loss tolerant mode:

- Citrix Virtual Delivery Agent (VDA) 2308
- Citrix Workspace app for Windows 2309

In addition, the following features must be enabled:

- [HDX Adaptive Transport policy](#).
- (Optional) For remote connections, [Citrix Gateway Service](#) is required.

Note:

If the conditions above are not met, audio is sent over the EDT Reliable transport.

Additional information

The loss tolerant mode is a loss-tolerant transport protocol that allows packet loss in transmission without resending multimedia content, resulting in a more real-time experience for users.

Enlightened Data Transport (EDT) is a Citrix-proprietary transport protocol that delivers a superior user experience on challenging long-haul connections while maintaining server scalability. Loss tolerant mode is a feature of Citrix Gateway service that uses the loss tolerant mode as the transport protocol to maintain a stable connection even in the face of network congestion. This ensures a consistent and stable experience for remote workers. During normal conditions, both EDT and the loss tolerant mode provide similar results. However, during network conditions with packet loss, loss tolerant mode provides a better audio experience compared to EDT. This makes it an essential feature for remote workers who rely on real-time multimedia for their work.

Audio quality

In general, higher sound quality consumes more bandwidth and server CPU utilization by sending more audio data to user devices. Sound compression allows you to balance sound quality against overall session performance; use Citrix policy settings to configure the compression levels to apply to sound files.

By default, the **Audio quality policy** setting is set to High - high definition audio when TCP transport is used. The policy is set to Medium - optimized-for-speech when UDP transport (recommended) is used. The **High Definition audio** setting provides high fidelity stereo audio, but consumes more bandwidth than other quality settings. Do not use this audio quality for non-optimized voice chat or video chat applications (such as softphones). The reason is that it might introduce latency into the audio path

that is not suitable for real-time communications. We recommend the optimized for speech policy setting for real-time audio, regardless of the selected transport protocol.

When the bandwidth is limited, for example satellite or dial-up connections, reducing audio quality to **Low** consumes the least possible bandwidth. In this situation, create separate policies for users on low-bandwidth connections so that users on high-bandwidth connections are not adversely impacted.

For setting details, see [Audio policy settings](#). Remember to enable Client audio settings on the user device.

Bandwidth guidelines for audio playback and recording:

- Adaptive audio (default)
 - Bitrate: variable adaptive
 - Number of channels: 2 (Stereo) for playback, 1 (mono) for microphone capture
 - Frequency: 48000 Hz
 - Bit-depth: 16-bit
- High quality
 - Bitrate: ~100 kbps (min 75, max 175 kbps) for playback / ~70 kbps for microphone capture
 - Number of Channels: 2 (Stereo) for playback, 1 (mono) for microphone capture
 - Frequency: 44100 Hz
 - Bit-depth: 16-bit
- Medium quality (recommended for VoIP)
 - Bitrate: ~16 kbps (min 20, max 40 kbps) for playback, ~16 kbps for microphone capture
 - Number of Channels: 1 (Mono) for both playback and capture
 - Frequency: 16000 Hz (wideband)
 - Bit-depth: 16-bit
- Low quality
 - Bitrate: ~ 11 kbps (min 10; max 25 kbps) for playback, ~11 kbps for microphone capture
 - Number of Channels: 1 (Mono) for both playback and capture
 - Frequency: 8000 Hz (narrowband)
 - Bit-depth: 16-bit

Client audio redirection

To allow users to receive audio from an application on a server through speakers or other sound devices on the user device, leave the **Client audio redirection** setting at **Allowed**. This is the default.

Client audio mapping puts extra load on the servers and the network. However, prohibiting client audio redirection disables all HDX audio functionality.

For setting details, see [Audio policy settings](#). Remember to enable client audio settings on the user device.

Client microphone redirection

To allow users to record audio using input devices such as microphones on the user device, leave the **Client microphone redirection** setting at its default (Allowed).

For security, user devices alert their users, when servers they don't trust, try to access microphones. Users can choose to accept or reject access before using the microphone. Users can disable this alert on the Citrix Workspace app.

For setting details, see [Audio policy settings](#). Remember to enable Client audio settings on the user device.

Audio Plug N Play

The Audio Plug N Play policy setting allows or prevents the use of multiple audio devices to record and play sound. This setting is **Enabled** by default. Audio Plug N Play enables audio devices to be recognized. The devices are recognized even if they are not plugged in until after the user session has started.

This setting applies only to Windows Multi-session OS machines.

For setting details, see [Audio policy settings](#).

Audio redirection bandwidth limit and audio redirection bandwidth limit percent

The Audio redirection bandwidth limit policy setting specifies the maximum bandwidth (in kilobits per second) for a playing and recording audio in a session.

The Audio redirection bandwidth limit percent setting specifies the maximum bandwidth for audio redirection as a percentage of the total available bandwidth.

By default, zero (no maximum) is specified for both settings. If both settings are configured, the one with the lowest bandwidth limit is used.

For setting details, see [Bandwidth policy settings](#). Remember to enable Client audio settings on the user device.

Audio over UDP Real-time Transport and Audio UDP port range

By default, Audio over User Datagram Protocol (UDP) Real-time Transport is allowed (when selected at the time of installation). It opens up a UDP port on the server for connections that use Audio over UDP Real-time Transport. If there is network congestion or packet loss, we recommend configuring UDP/RTP for audio to ensure the best possible user experience. For any real time audio such as soft-phone applications, UDP audio is preferred to EDT. UDP allows for packet loss without retransmission, ensuring that no latency is added on connections with high packet loss.

Important:

When Citrix Gateway is not in the path, audio data transmitted with UDP is not encrypted. If Citrix Gateway is configured to access Citrix Virtual Apps and Desktops resources, then audio traffic between the endpoint device and Citrix Gateway is secured using DTLS protocol.

The Audio UDP port range specifies the range of port numbers that the Windows VDA uses to exchange audio packet data with the user device.

By default, the range is 16500 through 16509.

Note:

If Audio over UDP Real-time Transport is not required for adaptive audio, Citrix recommends configuring the policy setting to Disabled. This helps avoid Citrix Workspace app clients requesting open UDP connections or triggering unwanted Citrix Workspace app client firewall configuration dialog windows to appear.

For setting details about Audio over UDP Real-time Transport, see [Audio policy settings](#). For details about Audio UDP port range, see [Multi-stream connections policy settings](#). Remember to enable Client audio settings on the user device.

Audio over UDP requires the Windows VDA. For supported policies on the Linux VDA, see [Policy support list](#).

Audio setting policies for user devices

1. Load the group policy templates by following [Configuring the Group Policy Object administrative template](#).
2. In the Group Policy Editor, expand **Administrative Templates > Citrix Components > Citrix Workspace > User Experience**.
3. For **Client audio settings**, select **Not Configured**, **Enabled**, or **Disabled**.
 - **Not Configured**. By default, Audio Redirection is enabled using high quality audio or the previously configured custom audio settings.

- **Enabled.** Enables audio redirection using the selected options.
 - **Disabled.** Disables audio redirection.
4. If you select **Enabled**, choose a sound quality. For UDP audio, use **Medium** (default).
 5. For UDP audio only, select **Enable Real-Time Transport** and then set the range of incoming ports to open in the local Windows firewall.
 6. To use UDP Audio with Citrix Gateway, select **Allow Real-Time Transport Through gateway**. Configure Citrix Gateway with DTLS. For more information, see [this article](#).

As an Administrator, if you do not have control on endpoint devices to make these changes, use the default.ica attributes from StoreFront to enable UDP Audio. For example, for bring your own devices or home computers.

1. On the StoreFront machine, open C:\inetpub\wwwroot\Citrix\\App_Data\default.ica with an editor such as notepad.
2. Make the following entries under the [Application] section.
 - ; This text enables Real-Time Transport
EnableRtpAudio=true
 - ; This text allows Real-Time Transport Through gateway
EnableUDPThroughGateway=true
 - ; This text sets audio quality to Medium
AudioBandwidthLimit=1
 - ; UDP Port range
RtpAudioLowestPort=16500
RtpAudioHighestPort=16509

If you enable User Datagram Protocol (UDP) audio by editing default.ica, then UDP audio is enabled for all users who are using that store.

Avoid echo during multimedia conferences

Users in audio or video conferences might hear an echo. Echoes usually occur when speakers and microphones are too close to each other. For that reason, we recommend the use of headsets for audio and video conferences.

HDX provides an echo cancellation option (enabled by default) that minimizes any echo. The effectiveness of echo cancellation is sensitive to the distance between the speakers and the microphone. Ensure that the devices aren't too close or too far away from each other.

You can change a registry setting to disable echo cancellation. For information, see [Avoid echo during multimedia conferences](#) in the list of features managed through the registry.

Softphones

A softphone is software acting as a phone interface. You use a softphone to make calls over the internet from a computer or other smart device. By using a softphone, you can dial phone numbers and carry out other phone-related functions using a screen.

Citrix Virtual Apps and Desktops support several alternatives for delivering softphones.

- **Control mode.** The hosted softphone controls a physical telephone set. In this mode, no audio traffic goes through the Citrix Virtual Apps and Desktops server.
- **HDX RealTime optimized softphone support (recommended).** The media engine runs on user device, and Voice over Internet Protocol traffic flows peer-to-peer. For examples, see:
 - [HDX Optimization for Microsoft Teams](#)
 - [HDX RealTime Optimization Pack](#), which optimizes the delivery of Microsoft Skype for Business
 - [Cisco Jabber Softphone for VDI](#) (formerly known as VXME)
 - [Cisco Webex Meetings for VDI](#)
 - [Avaya VDI Equinox](#) (formerly known as VDI Communicator)
 - [Zoom VDI Plugin](#)
 - [Genesys PureEngage Cloud](#)
 - [Nuance Dragon PowerMic dictation device](#)
- **Local App Access.** A Citrix Virtual Apps and Desktops feature that allows an application such as a softphone to run locally on the Windows user device yet appear seamlessly integrated with their virtual/published desktop. This feature offloads all audio processing to the user device. For more information, see [Local App Access and URL redirection](#).
- **HDX RealTime generic softphone support.** Voice over Internet Protocol-over-ICA.

Generic softphone support

Generic softphone support enables you to host an unmodified softphone on XenApp or XenDesktop in the data center. The audio traffic goes over the Citrix ICA protocol (preferably using UDP/RTP) to the user device running the Citrix Workspace app.

Generic softphone support is a feature of HDX RealTime. This approach to softphone delivery is especially useful when:

- An optimized solution for delivering the softphone is not available and the user is not on a Windows device where Local App Access can be used.

- The media engine that is needed for optimized delivery of the softphone isn't installed on the user device or isn't available for the operating system version running on the user device. In this scenario, Generic HDX RealTime provides a valuable fallback solution.

There are two softphone delivery considerations using Citrix Virtual Apps and Desktops:

- How the softphone application is delivered to the virtual/published desktop.
- How the audio is delivered to and from the user headset, microphone, and speakers, or USB telephone set.

Citrix Virtual Apps and Desktops include numerous technologies to support generic softphone delivery:

- Optimized-for-Speech codec for fast encode of the real-time audio and bandwidth efficiency.
- Low latency audio stack.
- Server-side jitter buffer to smooth out the audio when the network latency fluctuates.
- Packet tagging (DSCP and WMM) for Quality of Service.
 - DSCP tagging for RTP packets (Layer 3)
 - WMM tagging for Wi-Fi

The Citrix Workspace app versions for Windows, Linux, Chrome, and Mac also are Voice over Internet Protocol capable. Citrix Workspace app for Windows offers these features:

- Client-side jitter buffer - Ensures smooth audio even when the network latency fluctuates.
- Echo cancellation - Allows for greater variation in the distance between microphone and speakers for workers who do not use a headset.
- Audio plug-n-play - Audio devices do not need to be plugged in before starting a session. They can be plugged in at any time.
- Audio device routing - Users can direct ringtone to speakers but the voice path to their headset.
- Multi-stream ICA - Enables flexible Quality of Service-based routing over the network.
- ICA supports four TCP and two UDP streams. One of the UDP streams supports the real-time audio over RTP.

For a summary of Citrix Workspace app capabilities, see [Citrix Receiver Feature Matrix](#).

System configuration recommendations

Client Hardware and Software:

For optimal audio quality, we recommend the latest version of Citrix Workspace app and a good quality headset that has acoustic echo cancellation (AEC). Citrix Workspace app versions for Windows, Linux, and Mac support Voice over Internet Protocol. Also, Dell Wyse offers Voice over Internet Protocol support for ThinOS (WTOS).

CPU Considerations:

Monitor CPU usage on the VDA to determine if it is necessary to assign two virtual CPUs to each virtual

machine. Real-time voice and video are data intensive. Configuring two virtual CPUs reduces the thread switching latency. Therefore, we recommend that you configure two vCPUs in a Citrix Virtual Desktops VDI environment.

Having two virtual CPUs does not necessarily mean doubling the number of physical CPUs, because physical CPUs can be shared across sessions.

Citrix Gateway Protocol (CGP), which is used for the Session Reliability feature, also increases CPU consumption. On high-quality network connections, you can disable this feature to reduce CPU consumption on the VDA. Neither of the preceding steps might be necessary on a powerful server.

UDP Audio:

Audio over UDP provides excellent tolerance of network congestion and packet loss. We recommend it instead of TCP when available.

LAN/WAN configuration:

Proper configuration of the network is critical for good real-time audio quality. Typically, you must configure virtual LANs (VLANs) because excessive broadcast packets can introduce jitter. IPv6-enabled devices might generate many broadcast packets. If IPv6 support is not needed, you can disable IPv6 on those devices. Configure to support Quality of Service.

Settings for use WAN connections:

You can use voice chat over LAN and WAN connections. On a WAN connection, audio quality depends on the latency, packet loss, and jitter on the connection. If delivering softphones to users on a WAN connection, we recommend using the NetScaler SD-WAN between the data center and the remote office. Doing so maintains a high Quality of Service. NetScaler SD-WAN supports Multi-Stream ICA, including UDP. Also, for a single TCP stream, it's possible to distinguish the priorities of various ICA virtual channels to ensure that high priority real-time audio data receives preferential treatment.

Use Director or the [HDX Monitor](#) to validate your HDX configuration.

Remote user connections:

Citrix Gateway supports DTLS to deliver UDP/RTP traffic natively (without encapsulation in TCP). Open firewalls bidirectionally for UDP traffic over Port 443.

Codec selection and bandwidth consumption:

Between the user device and the VDA in the data center, we recommend using the **Optimized-for-Speech** codec setting, also known as Medium Quality audio. Between the VDA platform and the IP-PBX, the softphone uses whatever codec is configured or negotiated. For example:

- G711 provides good voice quality but has a bandwidth requirement of from 80 kilobits per second through 100 kilobits per second per call (depending on Network Layer2 overheads).
- G729 provides good voice quality and has a low bandwidth requirement of from 30 kilobits per second through 40 kilobits per second per call (depending on Network Layer 2 overheads).

Delivering softphone applications to the virtual desktop

There are two methods by which you can deliver a softphone to the XenDesktop virtual desktop:

- The application can be installed in the virtual desktop image.
- The application can be streamed to the virtual desktop using Microsoft App-V. This approach has manageability advantages because the virtual desktop image is kept uncluttered. After being streamed to the virtual desktop, the application runs in that environment as if it was installed in the usual manner. Not all applications are compatible with App-V.

Delivering audio to and from the user device

Generic HDX RealTime supports two methods of delivering audio to and from the user device:

- **Citrix Audio Virtual Channel.** We generally recommend the Citrix Audio Virtual Channel because it's designed specifically for audio transport.
- **Generic USB Redirection.** Supports audio devices having buttons or a display (or both), human interface device (HID), if the user device is on a LAN or LAN-like connection back to the Citrix Virtual Apps and Desktops server.

Citrix audio virtual channel

The bidirectional Citrix Audio Virtual Channel (CTXCAM) enables audio to be delivered efficiently over the network. Generic HDX RealTime takes the audio from the user headset or microphone and compresses it. Then, it sends it over ICA to the softphone application on the virtual desktop. Likewise, the audio output of the softphone is compressed and sent in the other direction to the user headset or speakers. This compression is independent of the compression used by the softphone itself (such as G.729 or G.711). It is done using the Optimized-for-Speech codec (Medium Quality). Its characteristics are ideal for Voice over Internet Protocol. It features quick encode time, and it consumes only approximately 56 Kilobits per second of network bandwidth (28 Kbps in each direction), peak. This codec must be explicitly selected in the Studio console because it is not the default audio codec. The default is the HD Audio codec (High Quality). This codec is excellent for high fidelity stereo soundtracks but is slower to encode compared to the Optimized-for-Speech codec.

Generic USB Redirection

Citrix Generic USB Redirection technology (CTXGUSB virtual channel) provides a generic means of remoting USB devices, including composite devices (audio plus HID) and isochronous USB devices. This approach is limited to LAN-connected users. This reason being that the USB protocol tends to be sensitive to network latency and requires considerable network bandwidth. Isochronous USB redirection works well when using some softphones. This redirection provides excellent voice quality and low latency. However, Citrix Audio Virtual Channel is preferred because it is optimized for audio traffic. The primary exception is when you're using an audio device with buttons. For example, a USB telephone attached to the user device that is LAN-connected to the data center. In this case, Generic USB Redirection supports buttons on the phone set or headset that control features by sending a signal back to the softphone. There isn't an issue with buttons that work locally on the device.

Audio diagnostic command line tool

The audio diagnostic command line tool on the VDA can be used to query session data related to audio policies, configuration, and data transport.

Usage

Open a command prompt and run `CtxAudio.exe` from the `C:\Program Files\Citrix\HDX\bin` folder.

- Running the tool as an administrator displays all active ICA session(s) audio information.
- Running the tool as a non-administrator displays the current user's ICA session audio information.

Output

The tool outputs various configuration settings that can help diagnose audio-related issues within a session.

| Section | Description |
|----------------------|--|
| Policy information | Audio policies applied to the current session(s). |
| Settings information | Audio related configuration settings stored in the registry. |
| State information | Audio state, version, codecs, and transport applied to the current session(s). |
| Devices information | Device names, their roles, and their statuses used in the session. |

Note:

The output varies depending on if you run the tool on a multi-session (TS) VDA or a single-session VDA (WSVDA).

Limitation

You install an audio device on your client, enable the audio redirection, and start an RDS session. The audio files might fail to play and an error message appears.

As a workaround, add the registry key on the RDS machine, and then restart the machine. For information, see [Audio limitation](#) in the list of features managed through the registry.

Browser content redirection

April 10, 2024

Browser content redirection prevents the rendering of webpages in the allow list on the VDA side. This feature uses Citrix Workspace app for Windows or Citrix Workspace app for Linux to instantiate a corresponding rendering engine on the client side, which fetches the HTTP and HTTPS content from the URL.

Note:

You can specify that webpages be redirected to the VDA side (and not redirected to the client side) by using a block list.

This overlay web layout engine runs on the endpoint device instead of on the VDA and uses the endpoint CPU, GPU, RAM, and Network.

Only the browser viewport is redirected. The viewport is the rectangular area in your browser where the content is displayed. The viewport doesn't include things like the Address Bar, **Favorites** Toolbar, or **Status** Bar. Those items are in the user interface, which is still running on the browser in the VDA.

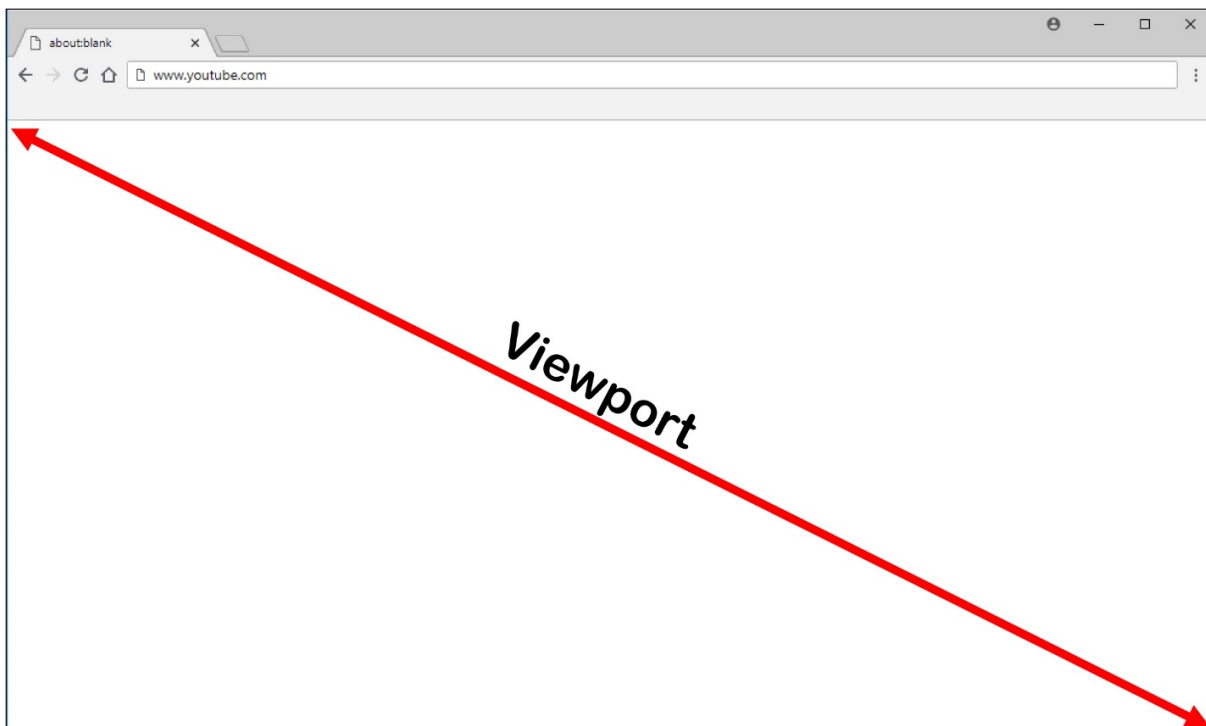

1. Configure a Studio policy that specifies an Access Control List containing the URLs in the allow list for redirection or the block list that disables redirection for specific URL paths. For the browser on the VDA to detect that the URL that the user is navigating to match the allow list or does not match a block list, a browser extension performs the comparison. For Chrome, the

browser extension is available in the Chrome Web Store, and you can deploy it using Group Policies and ADMX files. Chrome extensions are installed on a per-user basis. Updating a golden image to add or remove an extension is not required. For Microsoft Edge, the extension is not available directly. You must allow extensions from the Chrome store to find and install it.

2. If a match is found in the allow list (for example <https://www.mycompany.com/>), and there is no match to a URL in the block list (for example <https://www.mycompany.com/engineering>), a virtual channel (CTXCSB) instructs the Citrix Workspace app that a redirection is required and relays the URL. Citrix Workspace app then instantiates a local rendering engine and displays the website.
3. Citrix Workspace app then blends back the website into the virtual desktop browser content area seamlessly.

Note:

For more information on what's new and fixes for the browser content redirection extension, go to the Chrome Web Store and search for **citrix bcr** to find the extension.

The color of the logo specifies the status of the Chrome extension. It is one of these three colors:

- Green: Active and connected.
- Gray: Not active/idle on the current tab.
- Red: Broken/Not working.

You can debug logging by using **Options** in the extensions menu.

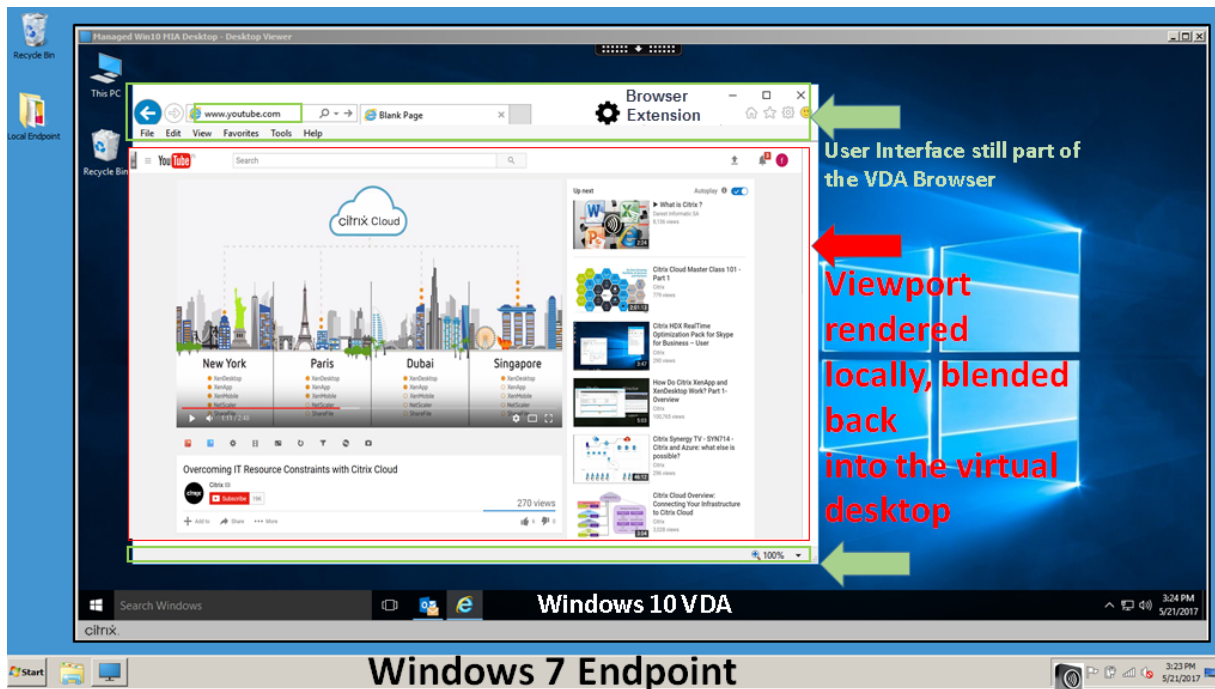

Here are scenarios of how the Citrix Workspace app fetches content:

- **Server fetch and server render:** There is no redirection because you didn't add the site to the allow list or the redirection failed. We fall back to rendering the webpage on the VDA and use Thinwire to remove the graphics. Use policies to control the fallback behavior. High CPU, RAM, and bandwidth consumption on the VDA.
- **Server fetch and client render:** Citrix Workspace app contacts and fetches content from the web server through the VDA using a virtual channel (CTXPFWD). This option is useful when the client doesn't have internet access (for example, thin clients). Low CPU and RAM consumption on the VDA, but bandwidth is consumed on the ICA virtual channel.

There are three modes of operation in this scenario. The term proxy refers to a proxy device that the VDA accesses to gain Internet access.

Which policy option to choose:

- **Explicit Proxy:** If you have a single explicit proxy in your data center.
- **Direct or Transparent:** If you do not have proxies, or if you use transparent proxies.
- **PAC files:** If you rely on PAC files browsers in the VDA can automatically choose the appropriate proxy server for fetching a specified URL.

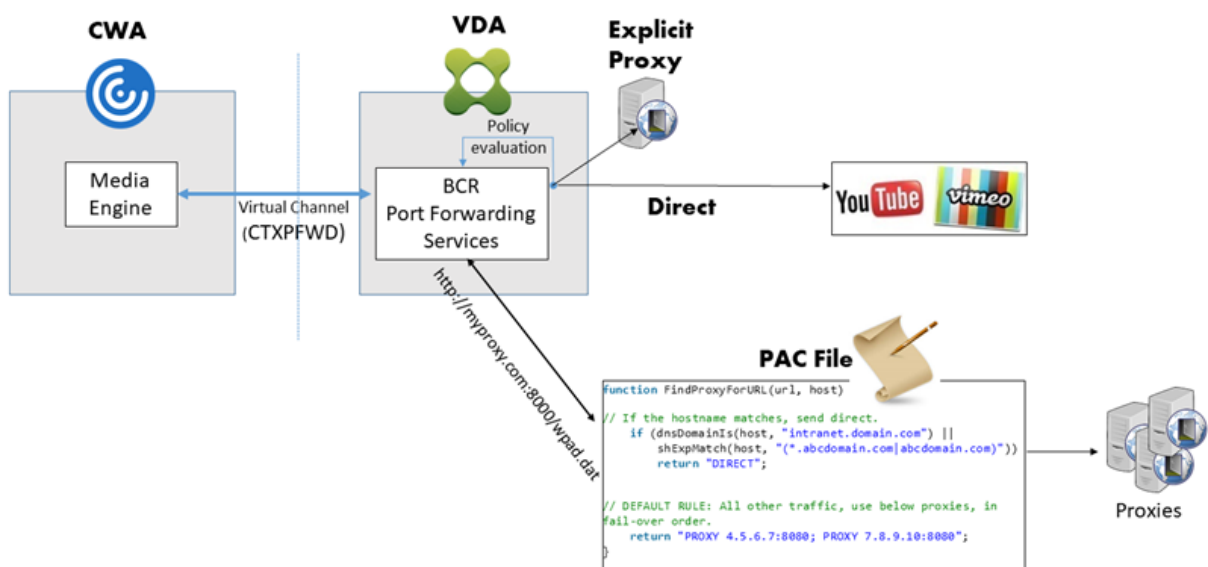

- **Client fetch and client render:** Because the Citrix Workspace app contacts the web server directly, it requires internet access. This scenario offloads all the network, CPU, and RAM usage from your XenApp and XenDesktop sites.

Benefits:

- Better end-user experience (Adaptive Bit Rate (ABR))

- Reduced VDA resource usage (CPU/RAM/IO)
- Reduced bandwidth consumption

Redirection scenarios

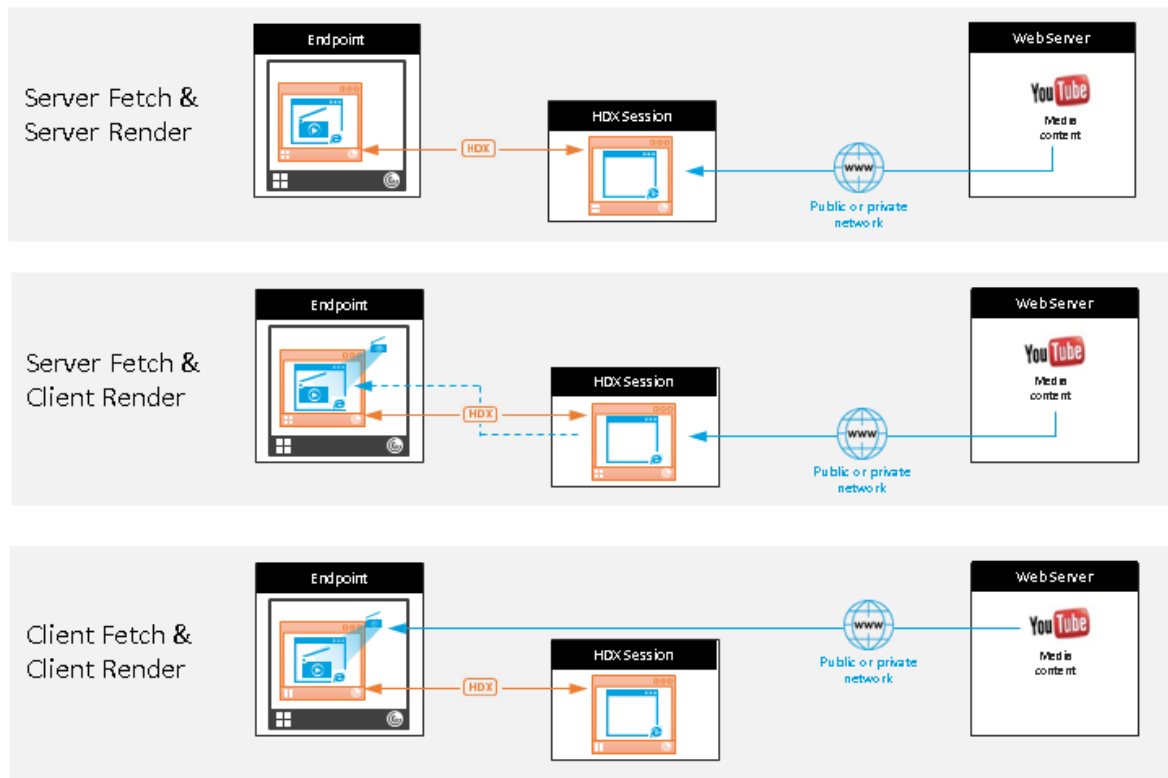

Fallback mechanism:

There might be times when client redirection fails. For example, if the client machine does not have direct internet access, an error response might go back to the VDA. In such cases, the browser on the VDA can then reload and render the page on the server.

You can suppress server rendering of video elements by using the existing **Windows Media fallback prevention** policy. Set this policy to **Play all content only on client** or **Play only client-accessible content on client**. These settings block video elements from playing on the server if there are failures in client redirection. This policy takes effect only when you enable browser content redirection and the **Access Control List** policy contains the URL that falls back. The URL can't be in the block list policy.

System requirements

Citrix Virtual Apps and Desktops

- Citrix Virtual Apps and Desktops 7 1808 or later

- XenApp and XenDesktop 7.15 CU5 or later
- VDA OS: Windows 10 and 11, Windows server 2016/2019/2022
- Browser on VDA:
 - Latest version of Google Chrome
 - Latest version of Microsoft Edge
- BCR extension from Chrome Web Store installed on the browser in the VDA

Windows endpoints

- Windows 10 and 11
- Citrix Workspace app 1809 for Windows or later

Note:

Browser content redirection is not supported on the Citrix Workspace app LTSR releases -1912 and 2203.1.

Linux endpoints

- Citrix Workspace app 1808 for Linux or later
- Thin client terminals must include WebKitGTK+

Mac endpoints (Preview)

- macOS 11 Big Sur
- macOS 12 Monterey
- macOS 13 Ventura
- macOS 14 Sonoma (up to 14.2.1) with Citrix Workspace app minimum version as 2311

Troubleshooting

For troubleshooting information, see the [How to troubleshoot browser content redirection Knowledge Center](#) article.

Browser content redirection Chrome extension

To use browser content redirection with Chrome, add the browser content redirection extension from the Chrome Web Store. Click **Add to Chrome** in the Citrix Virtual Apps and Desktops environment.

The extension is **not** required on the user's client machine –only in the VDA.

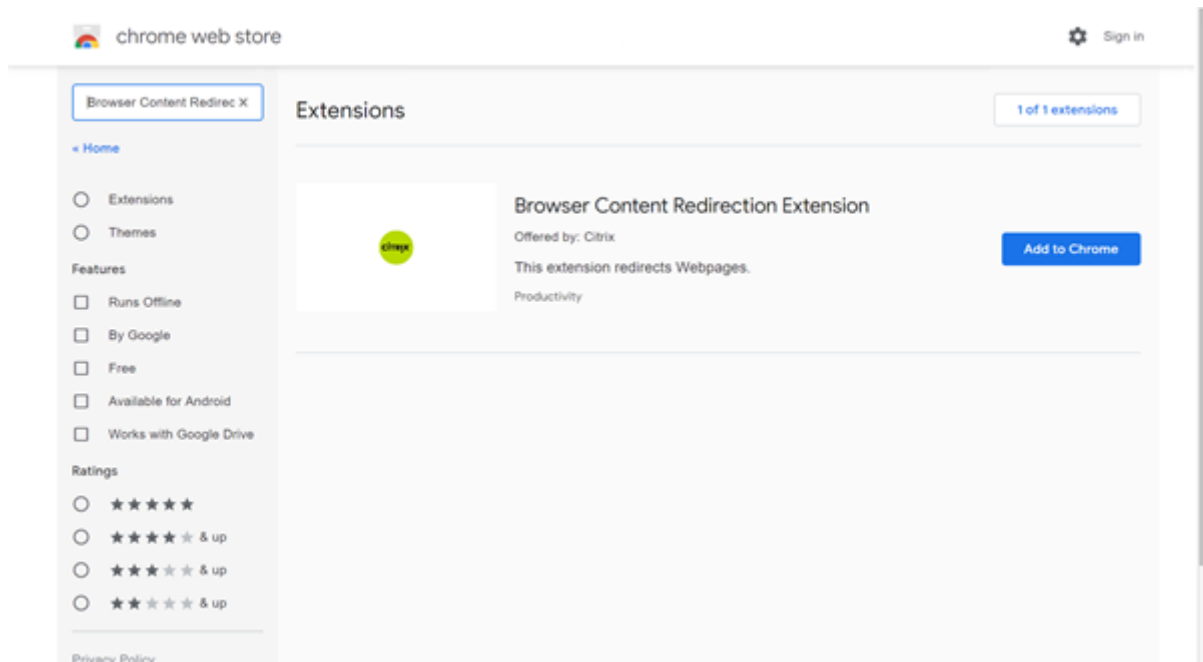

This method works for individual users. To deploy the extension to a large group of users in your organization, deploy the extension using Group Policy.

Deploy the extension using Group Policy

1. Import the Google Chrome ADMX files into your environment. For information about downloading policy templates and installing and configuring the templates into your Group Policy Editor, see [Set Chrome Browser policies on managed PCs](#).
2. Open your Group Policy Management console and go to **User Configuration \ Administrative Templates \ Classic Administrative Templates (ADM) \ Google \ Google Chrome \ Extensions**. Enable the **Configure the list of force-installed apps and extensions** setting.

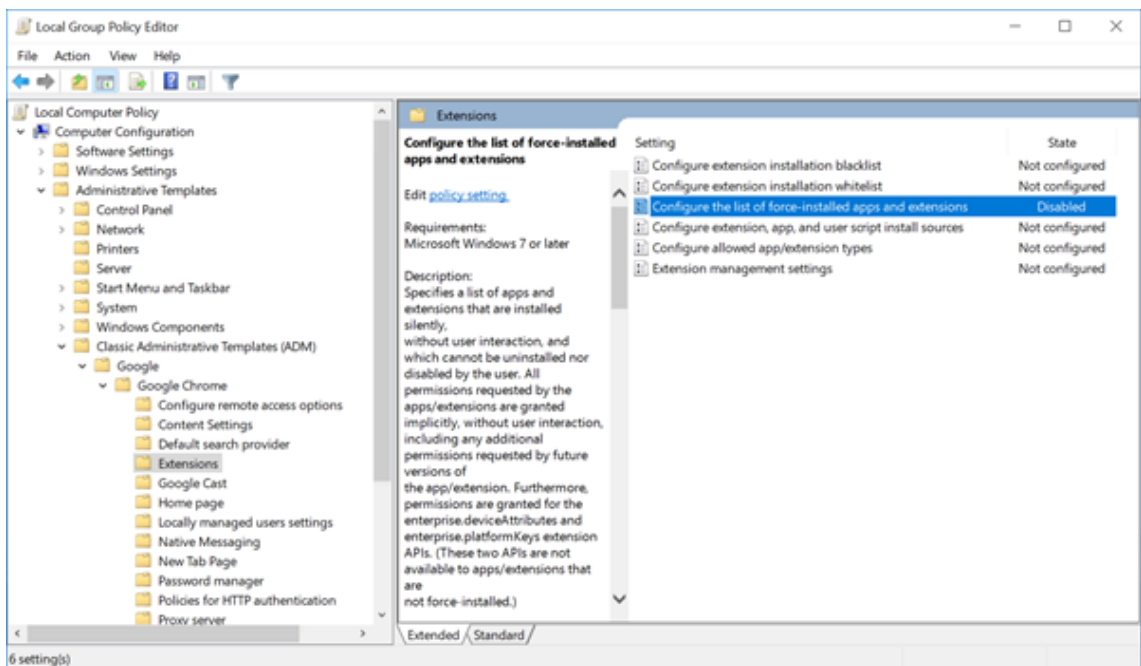

3. Click **Show** and type the following string corresponding to the extension ID. Update the URL for the browser content redirection extension.

hdppkjifljbdpckfajcmlblbchhledln; https://clients2.google.com/service/update2/crx

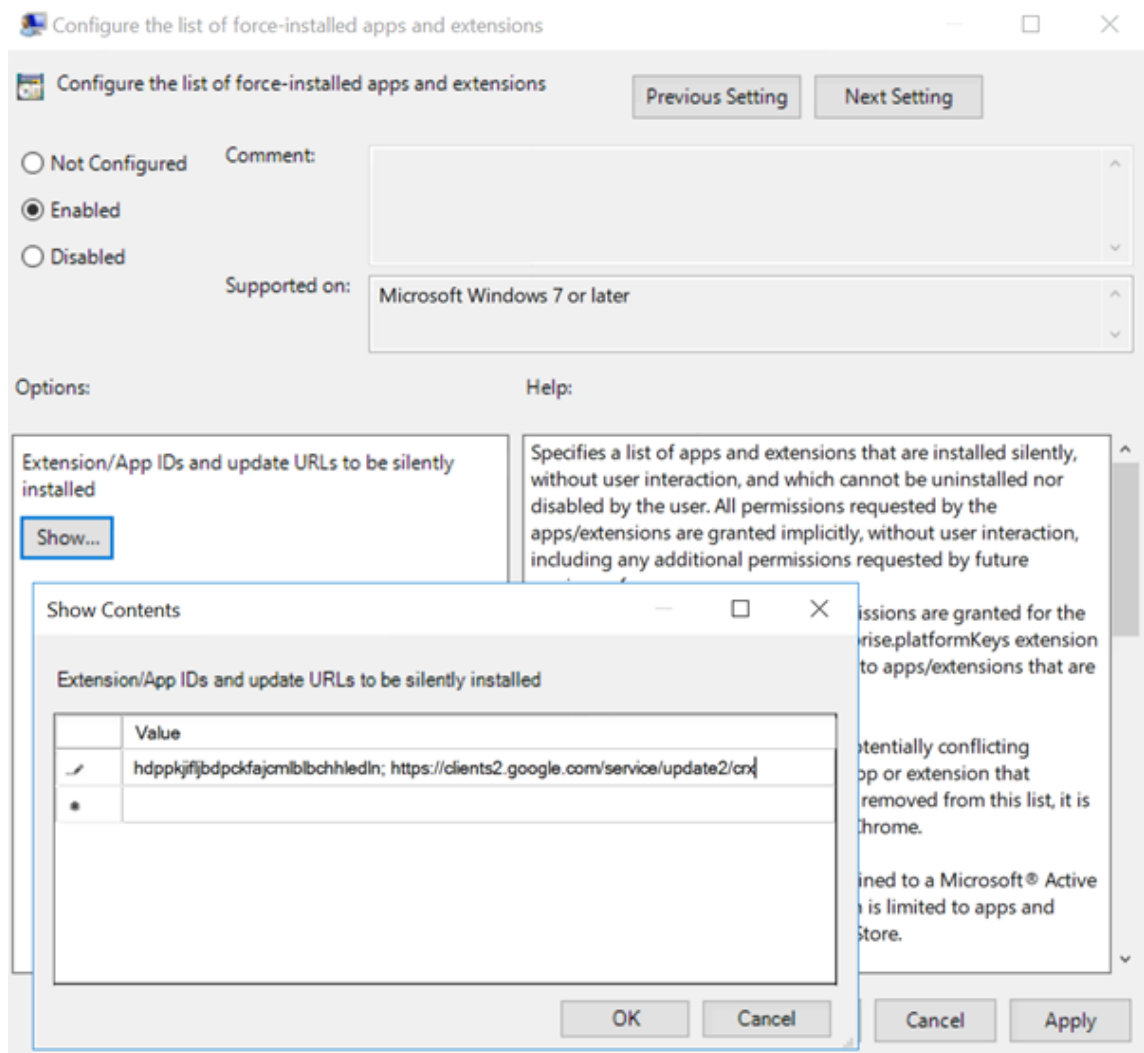

4. Apply the setting and after a **gpupdate** refresh, the user automatically receives the extension. If you launch the Chrome browser in the user's session, the extension is already applied and they cannot remove it.

Any updates to the extension are automatically installed on the users' machines through the update URL that you specified in the setting.

If the **Configure the list of force-installed apps and extensions** setting is set to **Disabled**, the extension is automatically removed from Chrome for all users.

Browser content redirection Edge Chromium extension

To install the browser content redirection extension in Edge, make sure you have version **83.0.478.37** or higher of the Edge browser installed.

1. Click the **Extensions** option. Choose **Manage extension**. Turn on **Allow extensions from other**

stores.

2. Click the **Chrome Web Store** link and the extension appears at the bar on the top right.

For more info on Microsoft Edge extensions, see [Extensions](#).

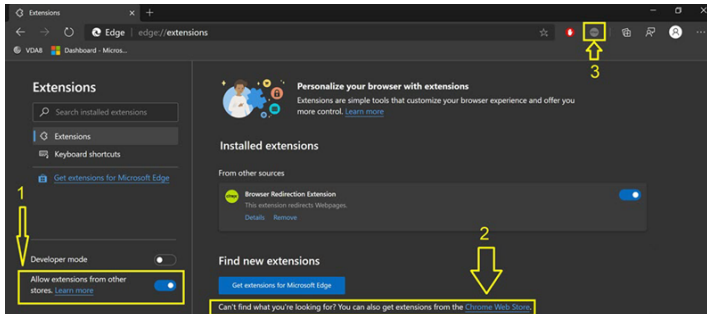
**Browser content redirection and DPI**

When you use browser content redirection with the DPI (scaling) set to anything over 100% on the user's machine, the redirected browser content screen displays incorrectly. To avoid this issue, do not set the DPI when using browser content redirection. Another way to avoid the issue is by disabling browser content redirection GPU acceleration for Chrome by creating the registry key on the user's machine. For information, see [Browser content redirection and DPI](#) in the list of features managed through the registry.

Single sign-on with Integrated Windows Authentication

Browser content redirection enhances the overlay to use the **Negotiate** scheme for authentication to web servers configured with Integrated Windows Authentication (IWA) within the same domain as the VDA.

By default, browser content redirection uses a basic authentication scheme that requires users to authenticate with their VDA credentials each time they access the web server. For single sign-on, you can either enable the **Browser content redirection Integrated Windows Authentication support** policy setting or create a registry key on the VDA.

Before enabling single sign-on, complete the following:

- Configure the Kerberos infrastructure to issue tickets for service principal names (SPNs) constructed from the host name. For example, [HTTP/serverhostname.com](http://serverhostname.com).
- For server fetch: When you use browser content redirection in server fetch mode, ensure that DNS is configured properly on the VDA.
- For client fetch: When you use browser content redirection in client fetch mode, ensure that DNS is configured properly on the client device and that you allow TCP connections from the overlay to the web server's IP address.

To configure single sign-on using the Browser content redirection policy, see the [Browser content redirection Integrated Windows Authentication support](#) setting.

Alternatively, you can enable single sign-on to a web server by adding a registry key on the VDA. For information, see [Single sign-on with Integrated Windows Authentication for browser content redirection](#) in the list of features managed through the registry.

User-agent request header

The user-agent header helps identify HTTP requests sent from browser content redirection. This setting can be useful when you configure proxy and firewall rules. For example, if the server blocks the requests sent from browser content redirection, you can create a rule that contains the user-agent header to bypass certain requirements.

Only Windows devices support the user-agent request header.

By default, the user-agent request header string is disabled. To enable the user-agent header for client-rendered content, use the Registry editor. For information, see [User-agent request header](#) in the list of features managed through the registry.

Browser content redirection client compatibility

You can use WMI to check if your client is compatible with browser content redirection. Use any method for accessing WMI works. The following is an example using PowerShell.

1. Open PowerShell.
2. Run `Get-WmiObject -Class CTXBCRStatus`.
3. Check the `BCR_Capable` parameter.
 - If `True`, the client is compatible with browser content redirection.
 - If `False`, the client is not compatible with browser content redirection.

Additional information

- If `CtxBrowserSvc` is not available, no results are displayed when running the command.
- If `CtxBrowserSvc` has never been run, the results return an invalid class error.

Browser content redirection limitations

Browser content redirection cannot support the following use cases:

- Web applications that require pop-up windows are not supported.

- Web applications that require Session cookie persistence are also not supported. Applications dependent on Google authentication service (For example, Google meet) can potentially be blocked.
- Extension plug-in is not officially published on the Microsoft Edge store. However, you can use the Chrome store to install the extensions.
- HTML5 video redirection policy must be disabled when Browser Content Redirection is in use.
- Browser Content Redirection is not supported on [ARMhf \(ARM hard float\) framework](#).
- Sometimes, users can also be disconnected from their sessions because of unreliable networks, highly variable network latency, or range limitations of wireless devices. Currently, BCR doesn't have sufficient fallback or reporting mechanisms for such scenarios.
- You cannot download files or print on the BCR overlay browser.

HDX video conferencing and webcam video compression

April 18, 2023

Warning:

Editing the registry incorrectly can cause serious problems that might require you to reinstall your operating system. Citrix cannot guarantee that problems resulting from the incorrect use of Registry Editor can be solved. Use Registry Editor at your own risk. Be sure to back up the registry before you edit it.

Webcams can be used by applications running within the virtual session by using HDX webcam video compression or HDX plug-n-play generic USB redirection. Use **Citrix Workspace app > Preferences > Devices** to switch between modes. Citrix recommends you always use HDX webcam video compression if possible. HDX generic USB redirection is recommended only when there are application compatibility issues with HDX video compression or when you require advanced native functionalities of the webcam. For better performance, Citrix recommends the Virtual Delivery Agent to have at least two virtual CPUs.

To prevent users from switching from HDX webcam video compression, disable USB device redirection by using the policy settings under **ICA policy settings > USB Devices policy** settings. Citrix Workspace app users can override the default behavior by choosing the Desktop Viewer Mic & Webcam setting **Don't use my microphone or webcam**.

HDX webcam video compression

HDX webcam video compression is also called **Optimized** webcam mode. This type of webcam video compression sends the H.264 video directly to the video conferencing application running in the vir-

tual session. To optimize VDA resources, HDX webcam compression doesn't encode, transcode, and decode webcam video. This feature is enabled by default.

To disable direct video streaming from the server to the video conferencing app, set the registry key to 0 on the VDA. For information, see [Webcam video compression](#) in the list of features managed through the registry.

If you disable the default functionality for streaming video resources, HDX webcam video compression uses the multimedia framework technology that is part of the client operating system to intercept video from capture devices, transcode, and compress it. Manufacturers of capture devices supply the drivers that plug into the OS kernel streaming architecture.

The client handles communication with the webcam. The client then sends the video only to the server that can display it properly. The server doesn't deal directly with the webcam, but its integration gives you the same experience in your desktop. Workspace app compresses the video to save bandwidth and provide better resiliency on WAN scenarios.

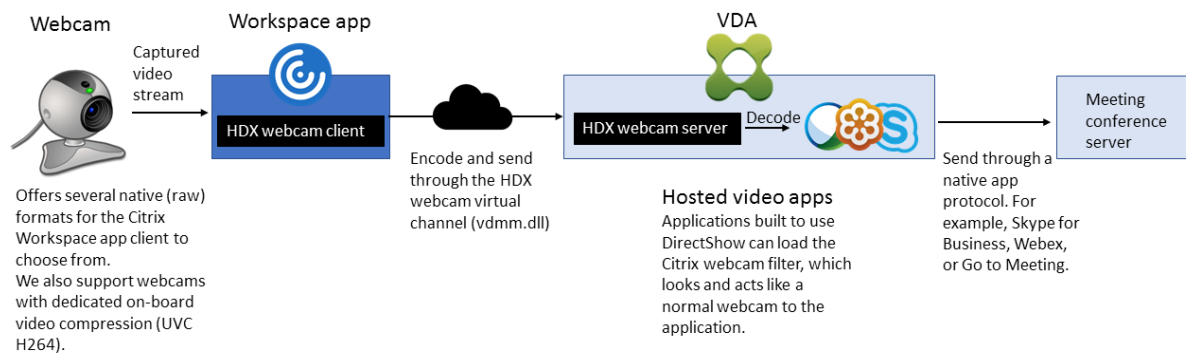

The **Multimedia conferencing** policy must be enabled for HDX webcam video compression. This policy is enabled by default.

If a webcam supports hardware encoding, HDX video compression uses the hardware encoding by default. Hardware encoding might consume more bandwidth than software encoding. To force software compression, edit the registry key on the client. For information, see [Webcam software compression](#) in the list of features managed through the registry.

HDX webcam video compression requirements

HDX webcam video compression supports the following versions of Citrix Workspace app:

| Platform | Processor |
|----------------------------------|---|
| Citrix Workspace app for Windows | Citrix Workspace app for Windows supports webcam video compression for 32-bit and 64-bit apps on XenApp and XenDesktop 7.17 and later. On earlier versions, Citrix Workspace app for Windows supports only 32-bit apps. |
| Citrix Workspace app for Mac | Citrix Workspace app for Mac 2006 or later supports webcam video compression for 64-bit apps on XenApp and XenDesktop 7.17 and later. On earlier versions, Citrix Workspace app for Mac supports only 32-bit apps. |
| Citrix Workspace app for Linux | Citrix Workspace app for Linux supports both 32-bit and 64-bit apps on the virtual desktop. |
| Citrix Workspace app for Chrome | Because some ARM Chromebooks don't support H.264 encoding, only 32-bit apps can use the optimized HDX webcam video compression. |

Media foundation-based video applications support HDX webcam video compression on Windows 8.x or higher and Windows Server 2012 R2 and higher. For more information, see Knowledge Center article [CTX132764](#).

Other user device requirements:

- Appropriate hardware to produce sound.
- DirectShow-compatible webcam (use the webcam default settings). Webcams that are hardware encoding capable reduce client-side CPU usage.
- For HDX webcam video compression, install webcam drivers on the client, obtained from the camera manufacturer, if possible. Installation of the device drivers isn't required on the server.

Different webcams offer different frame rates and have different levels of brightness and contrast. Adjusting the contrast of the webcam can reduce upstream traffic significantly. Citrix uses the following webcams for initial feature validation:

- Microsoft LifeCam VX models (2000, 3000, 5000, 7000)
- Creative Live! Cam Optia Pro
- Logitech QuickCam Messenger
- Logitech C600, C920
- HP Deluxe Webcam

To adjust the preferred video frame rate, edit the registry key on the client. For information, see [Webcam video compression frame rate](#) in the list of features managed through the registry.

High-definition webcam streaming

The video conferencing application on the server selects the webcam format and resolution based on the supported format types. When a session starts, the client sends the webcam information to the server. Choose a webcam from the application. When the webcam and the video conferencing application support high-definition rendering then the application uses high-definition resolution. We support all webcam resolutions.

This feature requires the Citrix Workspace app for Windows, minimum version 1808 or Citrix Receiver for Windows, minimum version 4.10.

You can use a registry key to disable and enable the feature. For information, see [High-definition webcam streaming](#) in the list of features managed through the registry.

If the media type negotiation fails, HDX falls back to the default VGA resolution (640 x 480 pixels). You can use registry keys on the client to configure the default resolution. Ensure that the camera supports the specified resolution. For information, see [High-definition webcam resolution](#) in the list of features managed through the registry.

HDX webcam video compression uses significantly less bandwidth compared to plug-n-play generic USB redirection and works well over WAN connections. To adjust the bandwidth, set the registry key on the client. For information, see [High-definition webcam bandwidth](#) in the list of features managed through the registry.

Enter a value in bits per second. If you don't specify the bandwidth, the video conferencing applications use 350000 bps by default.

HDX plug-n-play generic USB redirection

HDX plug-n-play generic USB redirection (isochronous) is also called **Generic** webcam mode. The benefit of HDX plug-n-play generic USB redirection is that you don't have to install drivers on your thin client/endpoint. The USB stack is virtualized such that anything you plug into the local client is sent to the remote VM. The remote desktop acts as if you plugged it in natively. The Windows desktop handles all the interaction with the hardware and runs through the plug-n-play logic to find the correct drivers. Most webcams work if the drivers exist on the server and can work over ICA. Generic webcam mode uses significantly more bandwidth (many Megabits per second) because you are sending uncompressed video down with USB protocol over the network.

HTML5 multimedia redirection

April 15, 2024

HTML5 multimedia redirection extends the multimedia redirection features of HDX MediaStream to include HTML5 audio and video. Because of the growth in online distribution of multimedia content, especially to mobile devices, the browser industry has developed more efficient ways to present audio and video.

Flash has been the standard, but it requires a plug-in, doesn't work on all devices, and has higher battery usage in mobile devices. Companies like YouTube, Netflix, and newer browsers versions of Mozilla, Google, and Microsoft are moving to HTML5 making it the new standard.

HTML5-based multimedia have many advantages over proprietary plug-ins, including:

- Company-independent standards (W3C)
- Simplified digital rights management (DRM) workflow
- Better performance without the security issues raised by plug-ins

HTTP progressive downloads

HTTP progressive download is an HTTP-based pseudo-streaming method that supports HTML5. In a progressive download, the browser plays back a single file (encoded at a single quality) while it is being downloaded from an HTTP web server. The video is stored on the drive as it's received and is played from the drive. If you rewatch the video, the browser can load the video from cache.

For an example of a progressive download, see the [HTML5 video redirection test page](#). To inspect the video elements in the webpage and find the sources (mp4 container format) in HTML5 video tags, use the developer tools in your browser:

Comparing HTML5 and Flash

| Feature | HTML5 | Flash |
|--------------------------------------|-------|-------|
| Requires a proprietary player | No | Yes |
| Runs on mobile devices | Yes | Some |
| Running speed on different platforms | High | Slow |
| Supported by iOS | Yes | No |
| Resource usage | Less | More |
| Load faster | Yes | No |

Requirements

We support only redirection for progressive downloads in mp4 format. We don't support WebM and Adaptive bitrate streaming technologies like DASH/HLS.

We support the following, and use policies to control them. For more information, see [Multimedia policy settings](#).

- Server side render
- Server fetch client render
- Client side fetching and rendering

Minimum versions of Citrix Workspace app and Citrix Receiver:

- Citrix Workspace app 1808 for Windows
- Citrix Receiver for Windows 4.5
- Citrix Workspace app 1808 for Linux
- Citrix Receiver for Linux 13.5

| Minimum VDA browser version | Windows OS version/build/SP |
|---|---|
| Internet Explorer 11.0 | Windows 10 x86 (1607 RS1) and x64 (1607 RS1);
Windows 7 x86 and x64; Windows Server 2016
RTM 14393 (1607); Windows Server 2012 R2 |
| Firefox 47 Manually add the certificates to the Firefox certificate store or configure Firefox to search for certificates from a Windows trusted certificate store. For more information, see https://wiki.mozilla.org/CA:AddRootToFirefox | Windows 10 x86 (1607 RS1) and x64 (1607 RS1);
Windows 7 x86 and x64; Windows Server 2016
RTM 14393 (1607); Windows Server 2012 R2 |
| Chrome 51 | Windows 10 x86 (1607 RS1) and x64 (1607 RS1);
Windows 7 x86 and x64; Windows Server 2016
RTM 14393 (1607); Windows Server 2012 R2 |

Components of the HTML5 video redirection solution

- **HdxVideo.js** - JavaScript hook-intercepting video commands on the website. HdxVideo.js communicates with WebSocketService using Secure WebSockets (SSL/TLS).
- **WebSocket SSL Certificates**
 - For the CA (root): **Citrix XenApp/XenDesktop HDX In-Product CA** (C = US; S = Florida; L = Fort Lauderdale; O = Citrix Systems, Inc.; OU = XenApp and XenDesktop Engineering; CN =

Citrix XenApp and XenDesktop HDX In-Product CA)

Location: **Certificates (Local Computer) > Trusted Root Certification Authorities > Certificates.**

- For the end-entity (leaf): **Citrix XenApp/XenDesktop HDX Service** (C = US; S = Florida; L = Fort Lauderdale; O = Citrix Systems, Inc.; OU = XenApp and XenDesktop Engineering; CN = Citrix XenApp and XenDesktop HDX Service)

Location: **Certificates (Local Computer) > Personal > Certificates.**

- **WebSocketService.exe** - Runs on the local system and performs SSL termination and user session mapping. TLS Secure WebSocket listening on 127.0.0.1 port 9001.
- **WebSocketAgent.exe** - Runs on the user session and renders the video as instructed from WebSocketService commands.

How do I enable HTML5 video redirection?

In this release, this feature is available for controlled webpages only. It requires the addition of the HdxVideo.js JavaScript (included in the Citrix Virtual Apps and Desktops Installation media) to the webpages where the HTML5 multimedia content is available. For example, videos on an internal training site.

Websites like youtube.com, which are based on Adaptive Bitrate technologies (for example, HTTP Live Streaming (HLS) and Dynamic Adaptive Streaming over HTTP (DASH)), are not supported.

For more information, see [Multimedia policy settings](#).

Troubleshooting Tips

Errors might occur when the webpage tries to run HdxVideo.js. If the JavaScript fails to load, the HTML5 redirection mechanism fails. Ensure that there are no errors related to HdxVideo.js by inspecting the console in the developers tool windows of your browser. For example:

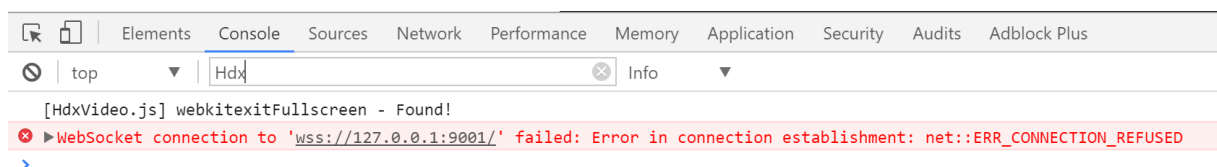

Optimization for Microsoft Teams

April 16, 2024

Note:

The new Microsoft Teams 2.1 is now generally available for VDA. This Microsoft Teams version is compatible with Citrix Microsoft Teams Optimization using WebRTC (VDI 1.0).

Starting with Citrix Virtual Apps and Desktops 2402, you don't need to manually configure the `msedgewebview2.exe` registry entry as it's whitelisted by default.

Published apps are now supported with the new Microsoft Teams.

Citrix delivers optimization for desktop-based Microsoft Teams using Citrix Virtual Apps and Desktops and Citrix Workspace app. By default, we bundle all the necessary components into the Citrix Workspace app and the Virtual Delivery Agent (VDA).

Our optimization for Microsoft Teams includes VDA-side HDX services and an API to interface with the Microsoft Teams hosted app to receive commands. These components open a control virtual channel (CTXMTOP) to the Citrix Workspace app-side media engine. The endpoint decodes and provides the multimedia locally, moving the Citrix Workspace app window back into the hosted Microsoft Teams app.

Authentication and signaling occur natively on the Microsoft Teams-hosted app, just like the other Microsoft Teams services (for example chat or collaboration). Audio/video redirection doesn't affect them.

The `CTXMTOP` is a command and control virtual channel. That means that media isn't exchanged between the Citrix Workspace app and the VDA.

Only client-fetch/client-render is available.

This video demonstration gives you an idea of how Microsoft Teams works in a Citrix virtual environment.

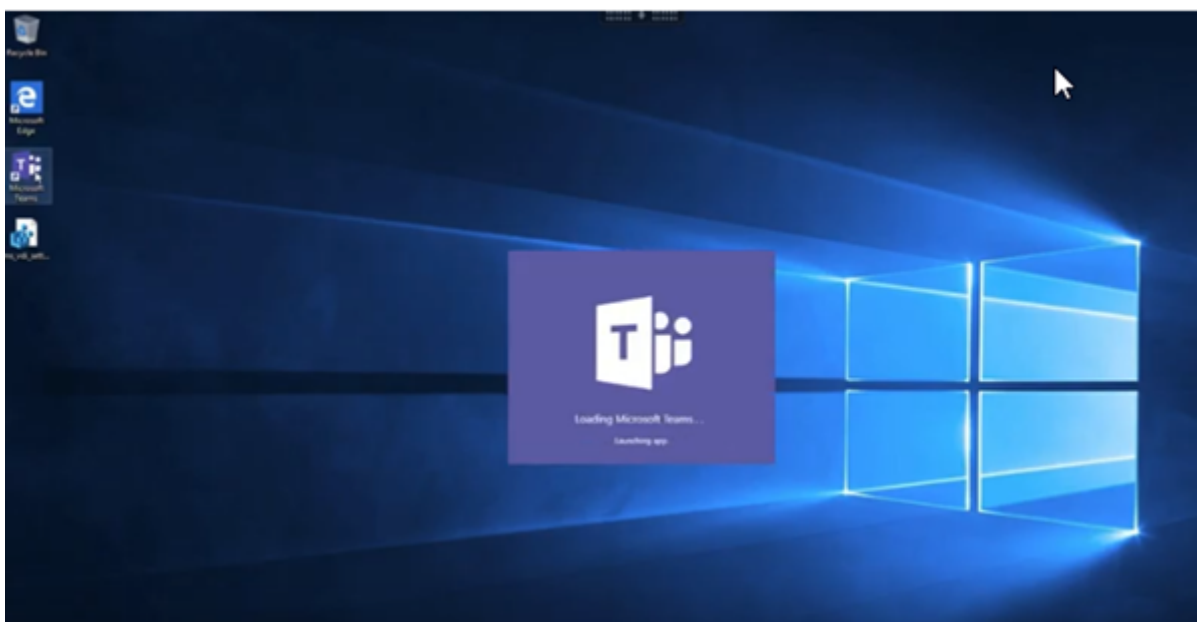

Microsoft Teams installation

Citrix and Microsoft recommend the latest available version of Microsoft Teams and to keep it up to date.

Microsoft Teams desktop app versions with release dates that are more than 90 days older than the current version's release date aren't supported.

Unsupported Microsoft Teams desktop app versions show a blocking page to users and request to update the app.

For information on the latest available versions, see [Update history for Microsoft Teams App \(Desktop and Mac\)](#).

We recommend that you follow the [Microsoft Teams machine-wide installation guidelines](#). Avoid using the .exe installer that installs Microsoft Teams in AppData. Instead, install in C:\Program Files (x86)\Microsoft\Teams by using the ALLUSER=1 flag from the command line.

```
msiexec /i <path_to_msi> /l*v <install_logfile_name> ALLUSER=1  
ALLUSERS=1
```

This example also uses the ALLUSERS=1 parameter. When you set this parameter, the Microsoft Teams Machine-Wide Installer appears in **Programs and Features** in the **Control Panel**. Also, in **Apps & features** in Windows Settings for all users of the computer. All users can then uninstall Microsoft Teams if they have administrator credentials.

It's important to understand the difference between ALLUSERS=1 and ALLUSER=1. You can use the ALLUSERS=1 parameter in non-VDI and VDI environments. Use the ALLUSER=1 parameter only in VDI environments to specify a per-machine installation.

In `ALLUSER=1` mode, the Microsoft Teams application doesn't auto-update whenever there's a new version. We recommend this mode for non-persistent environments, such as hosted shared apps or desktops out of a Windows Server or Windows 10 random/pooled catalogs. For more information, see [Install Microsoft Teams using MSI](#) (VDI Installation section).

Suppose you have a Windows 10 dedicated persistent VDI environment. You want the Microsoft Teams application to auto-update and prefer Microsoft Teams to install per-user under `Appdata/Local`. In this case, use the `.exe` installer or the MSI without `ALLUSER=1`.

Note:

Citrix recommends installing the VDA before installing Microsoft Teams in the golden image. This installation order is needed for the `ALLUSER=1` flag to take effect. If you installed Microsoft Teams in the virtual machine before installing the VDA, uninstall and reinstall Microsoft Teams.

For Remote PC Access

Citrix recommends that you install Microsoft Teams version 1.4.00.22472 or later after installing the VDA. Otherwise, you need to sign out and sign in again for Microsoft Teams to detect the VDA as expected. Version 1.4.00.22472 and later includes augmented logic run at Microsoft Teams launch time and sign-in time for VDA detection. These versions also include active session type identification (HDX, RDP or locally connected to the client machine). If you're locally connected, previous versions of Microsoft Teams might fail to detect and disable certain features or UI elements. For example, Breakout Rooms, pop-out windows for meetings and chats, or meeting reactions.

Important:

When you roam from a local session to an HDX session and if Microsoft Teams is kept open and running on the background, you must exit and relaunch Microsoft Teams to optimize with HDX correctly.

Conversely, if you use Microsoft Teams remotely via an optimized HDX session, disconnect the HDX session and reconnect to the same Windows session locally at the device. When working from the office, you must relaunch Microsoft Teams so it can correctly detect the Remote PC Access state (HDX or local). Because Microsoft Teams can only assess VDI mode at app launch time, and not while it is already running on the background. Without a restart, Microsoft Teams might fail to load features like pop-out Windows, Breakout Rooms, or meeting reactions.

For App Layering

If using Citrix App Layering to manage VDA and Microsoft Teams installations in different layers, you must create a registry key on Windows VDAs before installing Microsoft Teams with the `ALLUSER=1`

flag from the command line. For more information, see the *Optimization for Microsoft Teams with Citrix App Layering* section under [Multimedia](#).

Profile Management recommendations

We recommend using the machine-wide installer for Windows Server and Pooled VDI Windows 10 environments.

When the **ALLUSER=1** flag is passed to the MSI from the command line (the machine-wide installer), the Microsoft Teams app installs under `C:\Program Files (x86)` (~300 MB). The app uses `AppData\Local\Microsoft\TeamsMeetingAddin` for logs and `AppData\Roaming\Microsoft\Teams` (~600–700 MB) for user-specific configurations, caching of elements in the user interface, and so forth.

Important:

If you don't pass the **ALLUSER=1** flag, the MSI places the Teams.exe installer and `setup.json` under `C:\Program Files (x86)\Teams Installer`. A registry key (TeamsMachineInstaller) is added under: `HKEY_LOCAL_MACHINE \SOFTWARE\WOW6432Node\Microsoft\Windows\CurrentVersion\Run`

A subsequent user logon triggers the final installation in **AppData** instead.

Machine-wide installer

The following is an example of folders, desktop shortcuts, and registries created by installing a Microsoft Teams machine-wide installer on a Windows Server 2016 64-bit VM:

Folder:

- `C:\Program Files (x86)\Microsoft\Teams`
- `C:\Users\\AppData\Roaming\Microsoft\Teams`

Desktop Shortcut:

`C:\Program Files (x86)\Microsoft\Teams\current\Teams.exe`

Registry:

- `HKEY_LOCAL_MACHINE \SOFTWARE\WOW6432Node\Microsoft\Windows\CurrentVersion\Run`
- `HKEY_LOCAL_MACHINE \SOFTWARE\Microsoft\Windows\CurrentVersion\Run`
- `HKEY_CURRENT_USER \SOFTWARE\Microsoft\Windows\CurrentVersion\Run`
- Name: Teams
- Type: REG_SZ

- Value: `C:\Program Files (x86)\Microsoft\Teams\current\Teams.exe`

Note:

The registry location varies based on the underlying Operating Systems and bitness.

Recommendations

- We recommend disabling auto-start by deleting the Microsoft Teams registry keys. Doing so prevents many logons that occur at the same time (for example, at the beginning of your work day) from spiking up the VM's CPU.
- If the virtual desktop does not have a GPU/vGPU, we recommend setting **Disable GPU hardware acceleration** in the Microsoft Teams **Settings** to improve performance. This setting ("`disableGpu`": `true`) is stored in `%Appdata%\Microsoft\Teams\desktop-config.json`. You can use a logon script to edit that file and set the value to `true`.
- If using Citrix Workspace Environment Management (WEM), enable **CPU Spikes Protection** to manage processor consumption for Microsoft Teams.

Per-user installer

When using the `.exe` installer, the installation process differs. All the files are placed in AppData.

Folder:

- `C:\Users\\AppData\Local\Microsoft\Teams`
- `C:\Users\\AppData\Local\Microsoft\TeamsPresenceAddin`
- `C:\Users\\AppData\Local\Microsoft\TeamsMeetingAddin`
- `C:\Users\\AppData\Local\SquirrelTemp`
- `C:\Users\\AppData\Roaming\Microsoft\Teams`

Desktop shortcut:

```
C:\Users\\AppData\Local\Microsoft\Teams\Update.exe --processStart "Teams.exe"
```

Registry:

```
HKEY_CURRENT_USER \SOFTWARE\Microsoft\Windows\CurrentVersion\Run
```

Best Practices

The best practice recommendations are based on the use-case scenarios.

Using Microsoft Teams with a non-persistent setup requires a profile caching manager for efficient

Microsoft Teams runtime data synchronization. With a profile caching manager, the appropriate user-specific information is cached during the user session. For example, the user-specific information includes user data, profile, and settings. Synchronize the data in these two folders:

- `C:\Users\\AppData\Local\Microsoft\IdentityCache`
- `C:\Users\\AppData\Roaming\Microsoft\Teams`

Microsoft Teams cached content exclusion list for non-persistent setup Exclude the files and directories from the Microsoft Teams caching folder as described in the [Microsoft](#) documentation. This action helps you to reduce the user caching size to further optimize your non-persistent setup.

Use case: single-session scenario In this scenario, the end user uses Microsoft Teams in one location at a time. They don't need to run Microsoft Teams in two Windows sessions at the same time. In a common virtual desktop deployment, each user is assigned to one desktop, and Microsoft Teams is deployed in the virtual desktop as one application.

We recommend enabling the Citrix Profile container and redirecting the per-user directories listed in Per-user installer into the container.

1. Deploy the Microsoft Teams machine-wide installer (**ALLUSER=1**) in the golden image.
2. Enable Citrix Profile Management and set up the user profile store with the proper permissions.
3. Enable the following Profile Management policy setting: **File system > Synchronization > Profile container –List of folders to be contained in profile disk.**

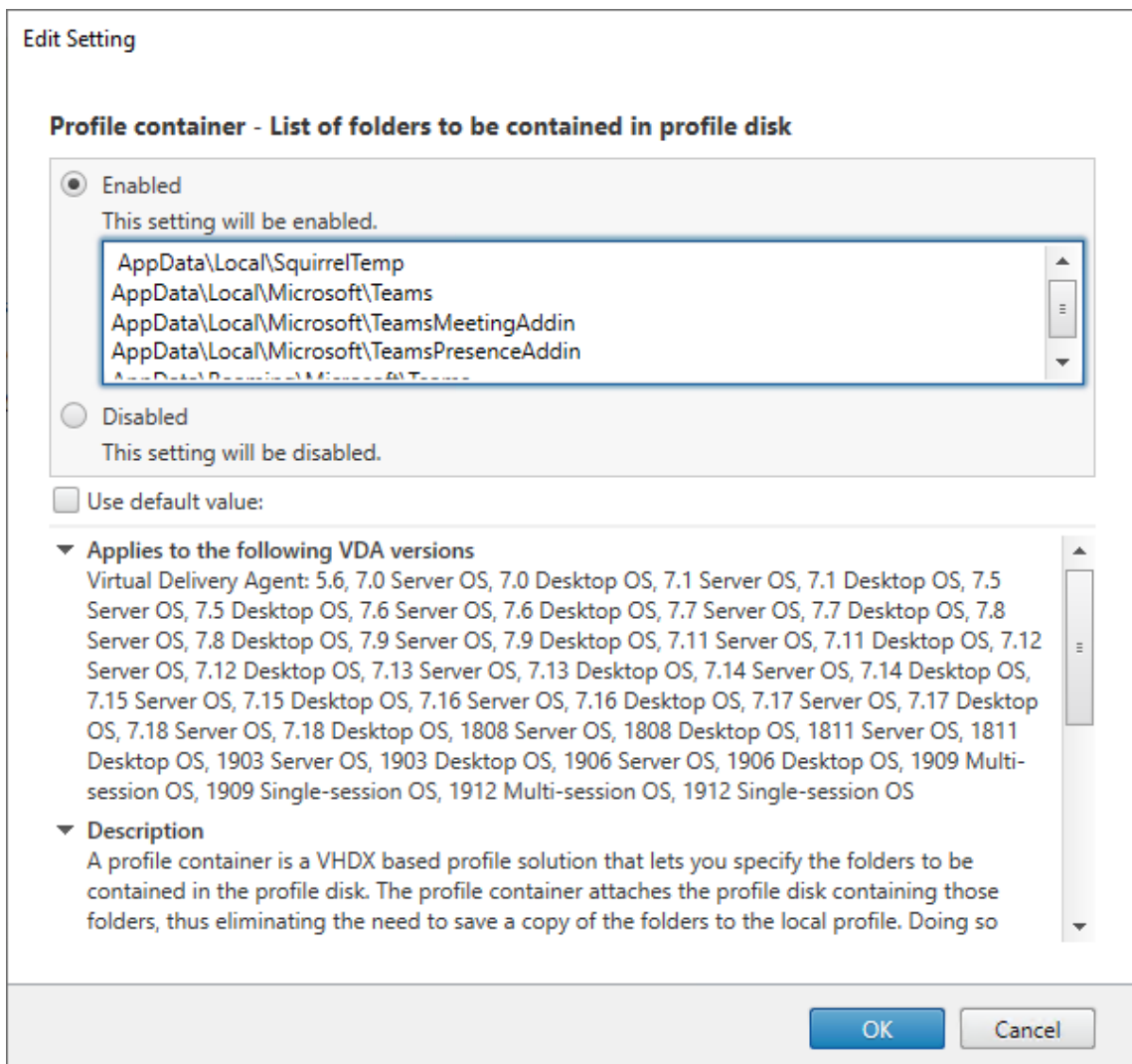

List all the per-user directories in this configuration. You can also configure these settings using the Citrix Workspace Environment Management (WEM) service.

4. Apply the settings to the correct delivery group.
5. Log in to validate the deployment.

System requirements

Minimum recommended version - Delivery Controller (DCs) 1906.2

If you're using an earlier version, see [Enable optimization of Microsoft Teams](#):

Supported operating systems:

- Windows Server 2022, 2019, 2016, 2012R2 Standard and data center Editions, and with the Server Core option

Minimum version - Virtual Delivery Agents (VDAs) 1906.2

Supported operating systems:

- Windows 11
- Windows 10 64-bit, versions 1607 and later. VM-hosted apps are supported in the Citrix Workspace app for Windows 2109.1 and later
- Windows Server 2022, 2019, 2016, and 2012 R2 (Standard and data center Editions)

Requirements:

- BCR_x64.msi - the MSI that includes the Microsoft Teams optimization code and starts automatically from the GUI. If you're using the command-line interface for the VDA installation, don't exclude it.

Recommended version –Citrix Workspace app for Windows latest CR and Minimum version - Citrix Workspace app 1907 for Windows

- Windows 11.
- Windows 10 (32-bit and 64-bit editions, including Embedded editions) (Support for Windows 7 stopped at Version 2006) (Support for Windows 8.1 stopped at version 2204.1).
- Windows 10 IoT Enterprise 2016 LTSC (v1607) and 2019 LTSC (v1809).
- Processor (CPU) architectures supported: x86 and x64 (ARM isn't supported).
- Endpoint requirement: Approximately 2.2–2.4 GHz dual-core CPU that can support 720p HD resolution during a peer-to-peer video conference call.
- Dual or quad-core CPUs with lower base speeds (~1.5 GHz) equipped with Intel Turbo Boost or AMD Turbo Core that can boost up to at least 2.4 GHz.
- HP Thin Clients verified: t630/t640, t730/t740, mt44/mt45.
- Dell Thin Clients verified: 5070, 5470 Mobile TC and AIO.
- 10ZiG Thin Clients verified: 4510 and 5810q.
- For a complete list of verified endpoints, see [Thin Clients](#).
- Citrix Workspace app requires at least 600 MB of free disk space and 1 GB RAM.
- The Microsoft .NET Framework minimum requirement is version 4.8. Citrix Workspace app automatically downloads and installs the .NET Framework if it's not present in the system.

Administrators can enable/disable Microsoft Teams starting in optimized mode by changing the Microsoft Teams Optimization policy. Users starting in the optimized mode in the Citrix Workspace app can't disable Microsoft Teams.

Minimum version - Citrix Workspace app 2006 for Linux

For more information, see [Optimization for Microsoft Teams](#) in Citrix Workspace app for Linux documentation.

Software:

- [GStreamer](#) 1.0 or later or Cairo 2
- [libc++-9.0](#) or later
- [libgdk](#) 3.22 or later
- OpenSSL 1.1.1d
- [libnsl](#)
- Ubuntu 20.04 or later

Authentication enhancement:

- Libsecret library
- [libunwind-12](#) library. For more information, see [Adding the libunwind-12 library dependency for llvm-12](#).

Hardware:

- Minimum 1.8 GHz dual-core CPU that can support 720p HD resolution during a peer-to-peer video conference call
- Dual or quad-core CPU with a base speed of 1.8 GHz and a high Intel Turbo Boost speed of at least 2.9 GHz

For a complete list of verified endpoints, see [Thin Clients](#).

For more information, see [Prerequisites to install Citrix Workspace app](#).

You can disable Microsoft Teams optimization by updating the value of the **VDWEBRTC** field to Off in the `/opt/Citrix/ICAClient/config/module.ini` file. The default is VDWEBRTC=On. After the update is completed, restart the Session. (Root permission is required).

Minimum version - Citrix Workspace app 2012 for Mac

Supported operating systems:

- macOS Catalina (10.15).
- macOS Big Sur 11.0.1 and later.
- macOS Monterey.

Features supported:

- Audio

- Video
- Screen sharing optimization (incoming and outgoing)

Note:

The Citrix Viewer app requires access to macOS Security and Privacy preferences for screen sharing to work. Users configure this preference in **Apple menu > System preferences > Security & Privacy > Privacy tab > Screen recording** and select **Citrix Viewer**.

Microsoft Teams optimization works by default with Citrix Workspace app 2012 and later and macOS 10.15.

If you want to disable Microsoft Teams optimization, run this command in a terminal and restart the Citrix Workspace app:

```
defaults write com.citrix.receiver.nomas mtopEnabled -bool NO
```

Minimum version - Latest version of Citrix Workspace app for ChromeOS running on the latest version of ChromeOS

Hardware:

- Processors performing at par or better than the Intel i3, quad core 2.4 GHz.

Features supported:

- Audio
- Video
- Screen sharing optimization (incoming and outgoing) - disabled by default. See these [settings](#) for instructions on how to turn it on.

Single Server Scalability

This section provides recommendations and guidance to estimate how many users or virtual machines (VMs) can be supported on a single physical host. This is commonly referred to as Citrix Virtual Apps and Desktops Single Server Scalability (SSS). In the context of Citrix Virtual Apps (CVA) or session virtualization, it is also commonly known as user density. The idea is to find out how many users or VMs can be ran on a single piece of hardware running a major hypervisor.

Note:

This section includes guidance to estimate SSS. The guidance is high level and might not necessarily be specific to your unique situation or environment. The only way to truly understand Citrix Virtual Apps and Desktops SSS is to use a scalability or load testing tool such as Login VSI.

Citrix recommends using this guidance and these simple rules to quickly estimate SSS only. However, Citrix recommends using Login VSI or the load testing tool of your choice to validate results, especially before purchasing hardware or making any financial decisions.

Hardware (system under test)

- Dell PowerEdge R740
- Intel Xeon (Gold) 6126 @ 2.60 GHz (max Turbo 3.70 GHz), 12 cores per socket, dual socket with Hyperthreading enabled
- 382 GB of RAM
- Local SSD RAID 0 storage (11 disk) 6 TB

Software

A single virtual machine (40 logical processors) with Windows 2019 (TSVDA) running Citrix Virtual Apps and Desktops 2106

VMware ESXi 6.7

Terminology

- Knowledge worker workload: Includes Acrobat Reader, Freemind/Java, Photo viewer, Edge, and MS Office apps such as Excel, Outlook, PowerPoint, and Word.
- Baseline: Server Scalability tests run with knowledge worker workload (without Microsoft Teams).
- Microsoft Teams Workload: Knowledge worker typical workload + Microsoft Teams.

How Microsoft Teams is stress-tested

- Microsoft Teams is optimized with HDX. Hence, all the multimedia processing is offloaded to the endpoint or client and is not part of the measurement.
- All Microsoft Teams processes are stopped or killed, before the workload starts.
- Open Microsoft Teams (Cold start).
- Measure the time taken by Microsoft Teams to load and grab the focus of Microsoft Teams primary window.
- Switch to the chat window using keyboard shortcuts.
- Switch to the calendar window using keyboard shortcuts.
- Send the chat message to a specific user using keyboard shortcuts.
- Switch to the Microsoft Teams window using keyboard shortcuts.

Results

- 40% scalability impact with Microsoft Teams Workload (81 users), when compared to Baseline (137 users).
- Increasing the server capacity by ~40% (in CPU) restores the number of users as with the Baseline workload.
- 20% extra memory required with Microsoft Teams Workload, when compared to Baseline.
- Increase per user storage size by 512-1024 MB.
- ~50% increase in IOPS write, ~100% increase in IOPS reads. Microsoft Teams can have a significant impact in an environment with slower storage.

Feature matrix and version support

| Feature | Microsoft Teams (minimum version) | VDA (minimum version) | Citrix Workspace app for Windows CR (minimum version) | Citrix Workspace app for Mac (Minimum Version) | Citrix Workspace app for Linux (Minimum Version) | Citrix Workspace app for ChromeOS (Minimum Version) |
|-------------------------------------|-----------------------------------|-----------------------|---|--|--|---|
| Audio/Video (P2P and conference) | current version minus 90 days | 1906 | 1907 | 2009 | 2004 | 2105.5 |
| Screensharing | Current version minus 90 days | 1906 | 1907 | 2012 | 2006 | 2105.5 |
| i. Screen Indicator Red border | Current version minus 90 days | 1906 | 2002 | 2012 | 2006 | No |
| ii. Limit capture to Desktop Viewer | Current version minus 90 days | 1906 | 2009.5 | 2012 | 2006 | No |

| Feature | Microsoft Teams (minimum version) | VDA (minimum version) | Citrix Workspace app for Windows CR (minimum version) | Citrix Workspace app for Mac (Minimum Version) | Citrix Workspace app for Linux (Minimum Version) | Citrix Workspace app for ChromeOS (Minimum Version) |
|----------------------|-----------------------------------|-----------------------|---|--|--|---|
| iii. Multi-monitor | Current version minus 90 days | 1912 CU6+ | 2106 (1) | 2106 | 2106 | No |
| DTMF | Current version minus 90 days | N/A | 2102 | 2101 | 2101 | 2111.1 |
| Proxy Server support | Current version minus 90 days | N/A | 2012 (2) | 2104 (3) | 2101 (3) | 2305 |
| App Sharing | Current version minus 90 days | 2109 | 2109.1 | 2203.1 | 2209 | No |
| Live Captions | Current version minus 90 days | N/A (4) | 2109.1 | 2109 | 2109 | 2303 |
| Dynamic e911 | Current version minus 90 days | N/A | 2112.1 | 2112 | 2112 | 2112 |
| Give Control | Current version minus 90 days | N/A | 2112.1 | 2203.1 | No | No |
| Request Control | Current version minus 90 days | N/A | 2112.1 | 2203.1 | 2203 | 2303 |

| Feature | Microsoft Teams (minimum version) | VDA (minimum version) | Citrix Workspace app for Windows CR (minimum version) | Citrix Workspace app for Mac (Minimum Version) | Citrix Workspace app for Linux (Minimum Version) | Citrix Workspace app for ChromeOS (Minimum Version) |
|------------------------|-----------------------------------|-----------------------|---|--|--|---|
| MultiWindow | 1.5.00.11865 | 2112, 1912 CU6 (5) | 2112.1 | 2203.1 | 2203 | 2303 |
| Meeting Transcriptions | Current version minus 90 days | 2112.1, 1912 CU6+ | 2112 | 2203.1 | 2203 | 2303 |
| Background Blurring | Current version minus 90 days | 2112, 1912 CU6+ | 2207 | 2301 | 2212 | 2303 |

1. CD Viewer in full screen mode only. SHIFT+F2 is not supported.
2. Negotiate/Kerberos, NTLM, Basic, and Digest. Pac files are also supported.
3. Anonymous only.
4. If VDA is 2112 or higher, Live Captions only work if the Citrix Workspace app version is 2203.1 for MAC and 2203 Linux or 2112 for Windows. This is because Live Captions behave differently if Microsoft Teams is in Single Window UI mode or MultiWindow mode.
5. MultiWindow was introduced in the 2112 VDA but was back-ported to the VDA 1912 LTSR CU6 release.

Note:

- All features listed in **Citrix Workspace app for Windows 1912 CU6 (or later)** are applicable to Citrix Workspace app for Windows 2203.1 LTSR CU1.
- Microsoft has deprecated support for Single Window mode in Microsoft Teams. To comply, you must upgrade your VDA to 1912 CU6+ LTSR and Citrix Workspace app 2203 CU2+ or greater, which supports the MultiWindow mode.

Enable optimization of Microsoft Teams

To enable optimization for Microsoft Teams, use the Manage console policy described in the [Microsoft Teams redirection](#) policy. This policy is **ON** by default. In addition to this policy being

enabled, HDX checks to verify that the version of the Citrix Workspace app is at least the minimum required version. If you enabled the policy and the Citrix Workspace app version is supported, **HKEY_CURRENT_USER\Software\Citrix\HDXMediaStream\MSTeamsRedirSupport** is set to **1** automatically on the VDA. Microsoft Teams reads the key to load in VDI mode.

Note:

If you're using version 1906.2 or later VDAs or with older controller versions (for example, version 7.15) that don't have the policy available in the Manage console (Studio), your VDA can still be optimized. HDX optimization for Microsoft Teams is enabled by default in the VDA.

If you click **About > Version**, the **Citrix HDX Optimized** legend displays:

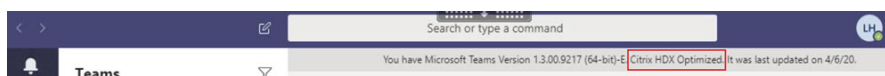

If you see **Citrix HDX Not Connected**, the Citrix API is loaded in Microsoft Teams. Loading the API is the first step toward redirection. But there's an error in later parts of the stack. The error is most likely in the VDA services or the Citrix Workspace app.

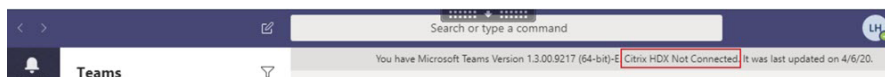

If you don't see any legend, Microsoft Teams failed to load the Citrix API. Exit Microsoft Teams by right-clicking the notification area icon and restarting. Make sure that the Manage console policy isn't set to **Prohibited** and that the Citrix Workspace app version is supported.

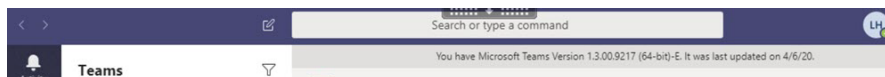

Important: session reconnects

- You might require to relaunch Microsoft Teams to get an HDX optimized session when your connectivity changes. For example, if you are roaming from an unsupported endpoint (Workspace app for iOS, Android, or old versions of Windows/Linux/Mac) to a supported one (Workspace app for Windows/Linux/Mac/ChromeOS/HTML5), or the opposite way.
- A Microsoft Teams relaunch is also required if you have installed the app using the Microsoft Teams .exe installer in the VDA. The .exe installer is recommended for persistent VDI deployments. In such cases, Microsoft Teams can auto-update while the HDX session is in the disconnected state. So, users reconnecting to an HDX session finds that the Microsoft Teams is not running optimized.
- When you roam from a local session to an HDX session, you must relaunch Microsoft Teams to optimize with HDX. This action is required in a Remote PC Access scenario.

Network requirements

Microsoft Teams relies on Media Processor servers in Microsoft 365 for meetings or multiparty calls. Also, Microsoft Teams relies on Microsoft 365 Transport Relays for these scenarios:

- Two peers in a point-to-point call do not have direct connectivity
- A participant does not have direct connectivity to the media processor.

So the network health between the peer and the Microsoft 365 cloud determines the performance of the call. Refer to [Microsoft 365 network connectivity principles](#) for detailed guidelines around network planning.

We recommend evaluating your environment to identify any risks and requirements that can influence your overall cloud voice and video deployment.

Use the [Skype for Business Network Assessment Tool](#) to test if your network is ready for Microsoft Teams. For support information, see [Support](#).

Summary of key network recommendations for Real Time Protocol (RTP) traffic

- Connect to the Microsoft 365 network as directly as possible from the branch office.
- Plan for and provide sufficient bandwidth at the branch office.
- Check each branch office for network connectivity and quality.
- If you must use any of the following at the branch office, make sure that RTP/UDP traffic (handled by HdxRtcEngine.exe in the Citrix Workspace app) is unhindered.
 - Bypass proxy servers
 - Network SSL intercept
 - Deep packet inspection devices
 - VPN hairpins (use split tunneling if possible)

Important: VPN Split tunnel configuration

HdxRtcEngine.exe traffic has to be diverted from the VPN tunnel and allowed to use the user's local Internet connection to connect directly to the service. The manner in which this is accomplished depends on the VPN product and machine platform used but most VPN solutions allow some simple configuration of policy to apply this logic. For more information on VPN platform-specific split tunnel guidance, see [this Microsoft article](#).

The WebRTC media engine in the Workspace app (HdxRtcEngine.exe) uses the Secure Real-time Transport Protocol (SRTP) for multimedia streams that are offloaded to the client. SRTP provides confidentiality and authentication to RTP. For this feature, symmetric keys (negotiated with DTLS) are used to encrypt media and control messages using the AES encryption cipher.

The following metrics are recommended for a positive user experience:

| Metric | Endpoint to Microsoft 365 |
|-----------------------------|-------------------------------|
| Latency (one way) | < 50 msec |
| Latency (RTT) | < 100 msec |
| Packet Loss | <1% during any 15s interval |
| Packet inter-arrival jitter | <30ms during any 15s interval |

For more information, see [Prepare your organization's network for Microsoft Teams](#).

For bandwidth requirements, optimization for Microsoft Teams can use a wide variety of codecs for audio (OPUS/G.722/PCM G711) and video (H264).

The peers negotiate these codecs during the call establishment process using the Session Description Protocol (SDP) Offer/Answer.

Citrix minimum recommendations per user are:

| Type | Bandwidth | Codec |
|------------------|------------|-------------------------|
| Audio (each way) | ~ 90 kbps | G.722 |
| Audio (each way) | ~ 60 kbps | Opus* |
| Video (each way) | ~ 700 kbps | H264 360p @ 30 fps 16:9 |
| Screen sharing | ~ 300 kbps | H264 1080p @ 15 fps |

* Opus supports constant and variable bitrate encoding from 6 kbps up to 510 kbps.

Opus and H264 are the preferred codecs for peer-to-peer and conference calls.

Important:

About performance, encoding is more expensive than decoding for CPU use at the client machine. You can hardcode the maximum encoding resolution in the Citrix Workspace app for Linux and Windows. See [Encoder performance estimator](#) and [Optimization for Microsoft Teams](#).

Proxy servers

Depending on the location of the proxy, consider the following:

- Proxy configuration on the VDA:

If you configure an explicit proxy server in the VDA and route connections to localhost through a proxy, redirection fails. To configure the proxy correctly, you must select the **Bypass proxy servers for local address** setting in **Internet Options > Connections > LAN Settings > Proxy Servers** and bypass `127.0.0.1:9002`.

If you use a PAC file, your VDA proxy configuration script from the PAC file must return **DIRECT** for `wss://127.0.0.1:9002`. If not, optimization fails. To make sure that the script returns **DIRECT**, use `shExpMatch(url, "wss://127.0.0.1:9002/*")`.

- Proxy configuration on Citrix Workspace app:

If the branch office is configured to access the internet through a proxy, these versions support proxy servers:

- Citrix Workspace app for Windows version 2012 (Negotiate/Kerberos, NTLM, Basic, and Digest. [Pac](#) files are also supported)
- Citrix Workspace app for Windows version 1912 CU5 (Negotiate/Kerberos, NTLM, Basic, and Digest. [Pac](#) files are also supported)
- Citrix Workspace app for Linux version 2101 (anonymous authentication)
- Citrix Workspace app for Mac version 2104 (anonymous authentication)

Client devices with earlier versions of the Citrix Workspace app can't read proxy configurations. These devices send traffic directly to Microsoft 365 TURN servers.

Important:

- Verify that the client device can connect to the DNS server to do DNS resolutions. A client device must be able to resolve the following Microsoft Teams Relay server's FQDNs:
 - `worldaz.relay.teams.microsoft.com`
 - `inaz.relay.teams.microsoft.com`
 - `uaeaz.relay.teams.microsoft.com`
 - `euaz.relay.teams.microsoft.com`
 - `usaz.relay.teams.microsoft.com`
 - `turn.dod.teams.microsoft.us`
 - `turn.gov.teams.microsoft.us`

If DNS requests are unsuccessful, P2P calls with outside users and conference calls with the media establishment fails.

- The location of the conference server is selected based on the first participant's virtual desktop location (and not the client).

Call establishment and media flow paths

When possible, the HDX WebRTC media engine in the Citrix Workspace app (HdxRtcEngine.exe) tries to establish a direct network Secure Real-time Transport Protocol (SRTP) connection over User Datagram Protocol (UDP) in a peer-to-peer call. If the UDP high ports are blocked, the media engine falls back to TCP/TLS 443.

The HDX media engine supports ICE, Session Traversal Utilities for NAT (STUN), and Traversal Using Relays around NAT (TURN) for candidate discovery and establishing connection. This support means that the endpoint must be able to perform DNS resolutions.

Consider a scenario where there is no direct path between the two peers or between a peer and a conference server and you are joining a multi-party call or meeting. The HdxRtcEngine.exe uses a Microsoft Teams transport relay server in Microsoft 365 to reach the other peer or the media processor, where meetings are hosted. Your client machine must have access to three Microsoft 365 subnet IP address ranges and four UDP ports (or TCP/TLS 443 as fallback if UDP is blocked). For more information, see the Architecture diagram in the Call setup and [Office 365 URLs and IP address ranges ID 11](#).

| ID | Category | Addresses | Destination Ports |
|----|-------------------|--|--|
| 11 | Optimize required | 13.107.64.0/18,
52.112.0.0/14,
52.120.0.0/14 | UDP: 3478, 3479, 3480,
3481, TCP: 443
(fallback) |

These ranges include both Transport Relays and media processors, front-ended by an Azure Load Balancer.

The Microsoft Teams Transport Relays provide STUN and TURN functionality, but they aren't ICE endpoints. Also, the Microsoft Teams Transport Relays don't terminate media, TLS, or do any transcoding. They can bridge TCP (if HdxRtcEngine.exe uses TCP) to UDP when they forward traffic to other peers or media processors.

Workspace app WebRTC media engine contacts the closest Microsoft Teams Transport Relay in the Microsoft 365 cloud. The media engine uses anycast IP and port 3478–3481 UDP (different UDP ports per workload, though multiplexing can happen) or 443 TCP/TLS for fallbacks. Call quality depends on the underlying network protocol. Because UDP is always recommended over TCP, we advise you to design your networks to accommodate UDP traffic in the branch office.

If Microsoft Teams loaded in optimized mode and HdxRtcEngine.exe is running on the endpoint, ICE failures might cause a call setup failure or one-way-only audio/video. When a call can't be completed or the media streams aren't full duplex, check the **Wireshark trace** on the endpoint first. For more information about the ICE candidate gathering process, see "Collecting logs" in the [Support](#) section.

Note:

If the endpoints don't have internet access, the users might still be able to make a peer-to-peer call if they are both on the same LAN. Meetings fail. In this case, there's a 30-second timeout before the call setup begins.

Call setup

Use this architecture diagram as a visual reference for the call flow sequence. The corresponding steps are indicated in the diagram.

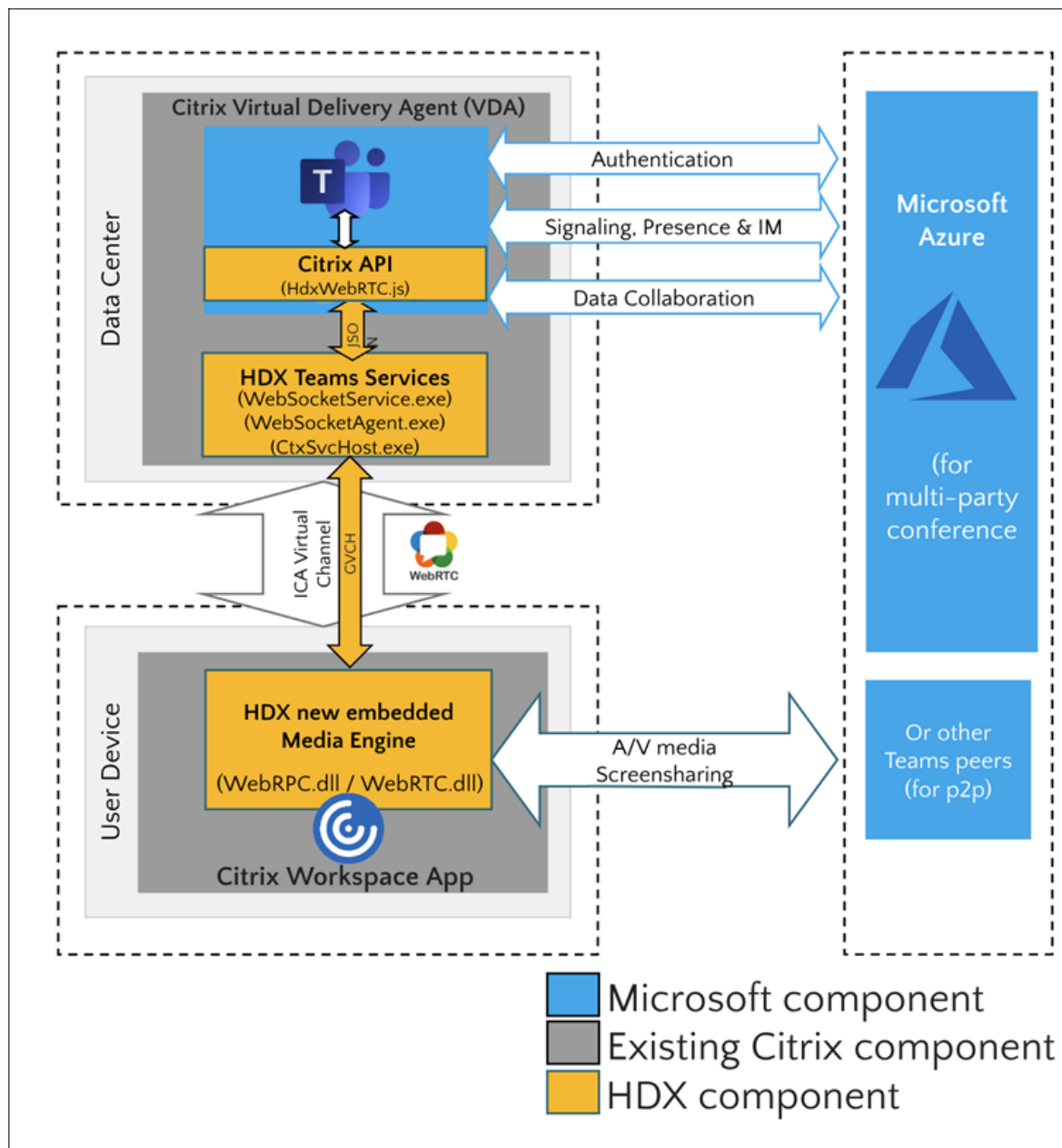

Architecture

1. Start Microsoft Teams.
2. Microsoft Teams authenticates to O365. Tenant policies are pushed down to the Microsoft Teams client, and relevant TURN and signaling channel information is relayed to the app.
3. Microsoft Teams detects that it's running in a VDA and makes API calls to the Citrix JavaScript API.
4. Citrix JavaScript in Microsoft Teams opens a secure WebSocket connection to WebSocketService.exe running on the VDA, which spawns WebSocketAgent.exe inside the user session.
5. WebSocketAgent.exe instantiates a generic virtual channel by calling into the Citrix HDX

Microsoft Teams Redirection Service (CtxSvcHost.exe).

6. Citrix Workspace app's wfica32.exe (HDX engine) spawns a new process called HdxRtcEngine.exe, which is the new WebRTC engine used for Microsoft Teams optimization.
7. Citrix media engine and Teams.exe have a 2-way virtual channel path and can start processing multimedia requests.

—User calls—

8. **Peer A** clicks the **call** button. Teams.exe communicates with the Microsoft Teams services in Microsoft 365, establishing an end-to-end signaling path with **Peer B**. Microsoft Teams asks HdxRtcEngine for a series of supported call parameters (codecs, resolutions, and so forth, which is known as a Session Description Protocol (SDP) offer). These call parameters are then relayed using the signaling path to the Microsoft Teams services in Microsoft 365 and from there to the other peer.
9. The SDP offer/answer (single-pass negotiation) takes place through the signaling channel, and the ICE connectivity checks (NAT and Firewall traversal using STUN bind requests) complete. Then, Secure Real-time Transport Protocol (SRTP) media flows directly between HdxRtcEngine.exe and the other peer (or Microsoft 365 conference servers if it's a meeting).

Microsoft Phone System

Phone System is Microsoft's technology that enables call control and PBX in the Microsoft 365 cloud with Microsoft Teams. Optimization for Microsoft Teams supports Phone System, using Microsoft 365 Calling Plans or Direct Routing. With Direct Routing, you can connect your own supported session border controller to the Microsoft Phone System directly without any additional on-premises software. Call queues, transfer, forward, hold, mute, and resume a call are supported.

DTMF

The dual-tone multi-frequency (DTMF) feature is supported with these versions of the Citrix Workspace app (and later):

- Citrix Workspace app for Windows version 2102
- Citrix Workspace app for Windows LTSR 1912 CU5 (Windows 10 OS only)
- Citrix Workspace app for Linux version 2101
- Citrix Workspace app for Mac version 2101
- Citrix Workspace app for ChromeOS version 2111.1

Support for dynamic e911

Starting with version 2112, the Citrix Workspace app supports dynamic emergency calling. When used in Microsoft Calling Plans, Operator Connect, and Direct Routing, it allows you to do the following:

- Configure and route emergency calls.
- Notify security personnel.

The notification is provided based on the current location of the Citrix Workspace app that runs on the endpoint, instead of the Microsoft Teams client that runs on the VDA.

Ray Baum's law requires the 911 caller's dispatchable location to be transmitted to the appropriate Public Safety Answering Point (PSAP). Microsoft Teams Optimization with HDX is compliant with Ray Baum's law when used with the following versions of the Citrix Workspace app:

- Citrix Workspace app for Windows version 2112.1 and later
- Citrix Workspace app for Linux version 2112 and later
- Citrix Workspace app for Mac version 2112 and later
- Citrix Workspace app for ChromeOS version 2112 and later

To enable dynamic emergency calling, the administrator must use the Microsoft Teams Admin Center and configure the following to create a network or emergency location map:

- Network settings
- Location Information Service (LIS)

For more information on Dynamic emergency calling, see [Microsoft's documentation](#).

The dispatchable location information that the Citrix Workspace app relays to Microsoft Teams are:

- Chassis ID / Port ID using Link Layer Discovery Protocol (LLDP) for Ethernet/Switch connections. Ethernet/Switch (LLDP) is supported on:
 - Windows versions 8.1 and 10
 - macOS, which requires LLDP enablement software. To download the LLDP enablement software, go to www.microsoft.com and search for LLDP enablement software.
 - Linux, which requires the LLDP library to be included in the operating system(OS) distribution of the Thin Client.
- WLAN BSSID and {IPv4-IPv6; Subnet; MAC Address} of the endpoint where Citrix Workspace app is installed.
 - Subnet and WiFi-based locations are supported on the Workspace app for Windows, Linux, and Mac.
- Latitude and Longitude, if user permission is granted at the OS-level where the Citrix Workspace app is installed (permission is set to HDX RTC Engine)

- Supported on all Workspace app platforms. However, for Citrix Workspace for Linux, you must include the `libgps` library in the OS distribution of the Thin Client (`>sudo apt-get install libgps23 gpsd lldpd`).

Firewall considerations

When users start an optimized call using the Microsoft Teams client for the first time, they might notice a warning with the **Windows firewall** settings. The warning asks for users to allow communication for `HdxTeams.exe` or `HdxRtcEngine.exe` (HDX Overlay Microsoft Teams).

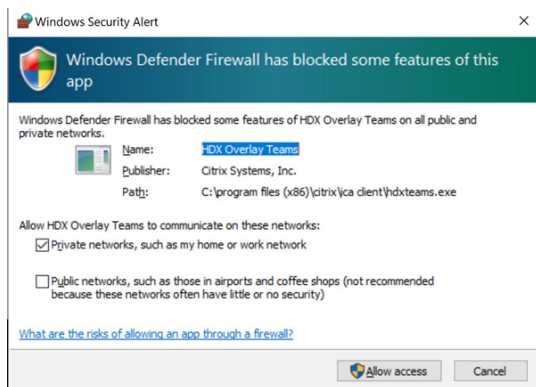

The following four entries are added under **Inbound Rules** in the **Windows Defender Firewall > Advanced Security** console. You can apply more restrictive rules if you want.

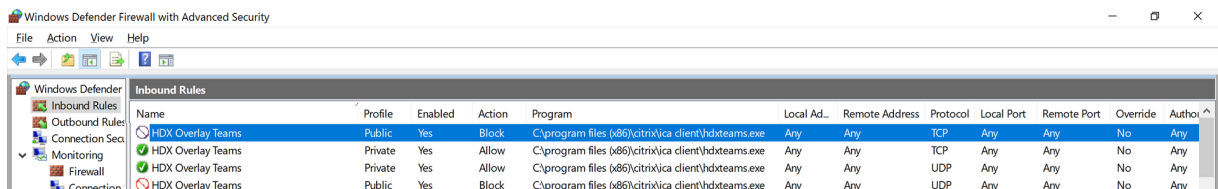

Microsoft Teams and Skype for Business Coexistence

You can deploy Microsoft Teams and Skype for Business side by side as two separate solutions with overlapping capabilities.

For more information, see [Understand Microsoft Teams and Skype for Business coexistence and interoperability](#).

Citrix RealTime Optimization Pack and HDX optimization for Microsoft Teams multimedia engines then honor the configuration set in your environment. Examples include island modes and Skype for Business with Microsoft Teams collaboration. Also, Skype for Business with Microsoft Teams collaboration and meetings.

Peripheral access can be granted only to a single application at the time. For example, webcam access by the RealTime Media Engine during a call locks the imaging device during a call. When the device is

released, it becomes available for Microsoft Teams.

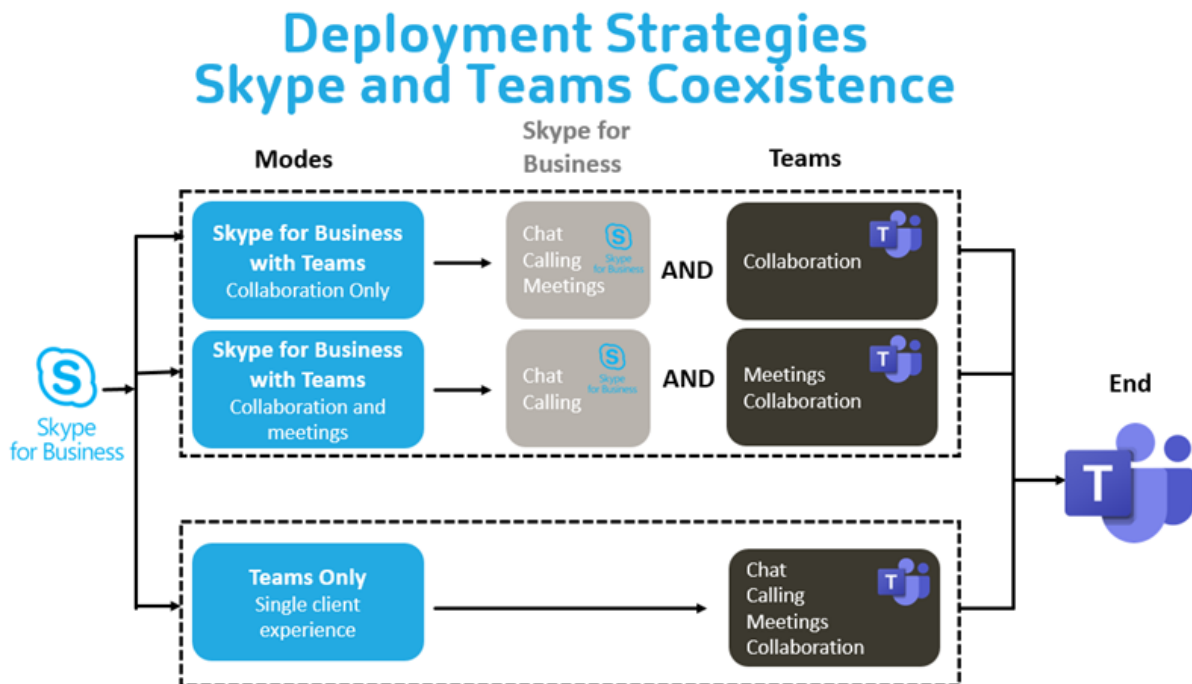

Citrix SD-WAN: optimized network connectivity for Microsoft Teams

Optimal audio and video quality require a network connection to the Microsoft 365 cloud that has low latency, low jitter, and low packet loss. Backhauling of Microsoft Teams audio-video RTP traffic from Citrix Workspace app users at branch office locations to a data center before going to the internet can add excessive latency. It might also cause congestion on WAN links. Citrix SD-WAN optimizes connectivity for Microsoft Teams following Microsoft 365 network connectivity principles. Citrix SD-WAN uses the Microsoft REST-based Microsoft 365 IP address and web service and proximate DNS. This use is to identify, categorize, and steer Microsoft Teams traffic.

Business broadband internet connections in many areas suffer from intermittent packet loss, periods of excessive jitter, and outages.

Citrix SD-WAN offers two solutions to preserve Microsoft Teams audio-video quality when network health is variable or degraded.

- If you use Microsoft Azure, a Citrix SD-WAN virtual appliance (VPX) deployed in the Azure VNET provides advanced connectivity optimizations. These optimizations include seamless link failover and audio packet racing.
- Citrix SD-WAN customers can connect to Microsoft 365 through the Citrix Cloud Direct service. This service provides reliable and secure delivery for all internet-bound traffic.

If the quality of the branch office internet connection isn't a concern, it might be enough to minimize

latency. Steer Microsoft Teams traffic directly from the Citrix SD-WAN branch appliance to the nearest Microsoft 365 front door to minimize latency. For more information, see [Citrix SD-WAN Office 365 optimization](#).

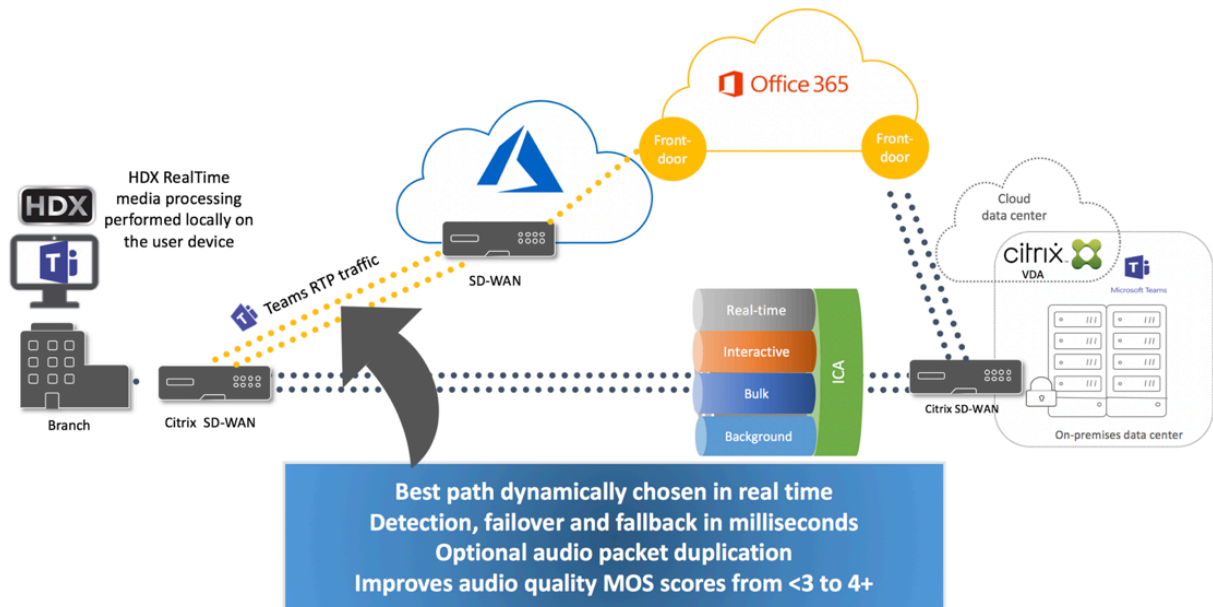

Multi-window meetings and chat

You can use multiple meetings or chat windows for Microsoft Teams in Windows. For details on the pop-out feature, see [Microsoft Teams Pop-Out Windows for Chats and Meetings](#) on the Microsoft 365 site.

Note:

This feature is supported with the Citrix Workspace app for Windows 2112.1, Mac 2203, Linux 2203, ChromeOS 2303. It requires VDA 2112 or greater and was back-ported to 1912 CU6+ LTSR.

Background blurring and background effects

Citrix Workspace app for Windows, Mac, Linux, and ChromeOS/HTML5 supports background blurring and background effects in Microsoft Teams optimization with HDX.

You can either blur or replace the background with a default image and avoid unexpected distractions by helping the conversation stay focused on the silhouette (body and face). You can use this feature with P2P or conference calls.

Note:

This feature is integrated with the Microsoft Teams UI/buttons. MultiWindow support is a pre-

requisite that requires a VDA update to 2112 or later. For more information, see [Multi-window meetings and chat](#).

Microsoft Teams UI controls on background blurring and effects require the following minimum versions:

- Citrix Workspace app for Windows 2207
- Citrix Workspace app for Mac 2301
- Citrix Workspace app for Linux 2307
- Citrix Workspace app for ChromeOS 2303

Limitations:

- The client must be connected to the internet while replacing the background image with a Microsoft Teams default image.
- Admin and user-defined background image replacement is not supported in the Microsoft Teams UI. Custom background images can be configured using configuration settings on the client, if the image is also stored on the client.

Setting a custom background image

The following registry keys are only required if you don't plan to use the Microsoft Teams UI to control the feature, or if an admin wants to override default behaviors. For example, disable background blurring because the endpoint is not powerful enough.

On Windows To set a custom background image, administrators or end-users must configure the following registry key on the client or endpoint:

Location: `HKEY_CURRENT_USER\SOFTWARE\Citrix\HDXMediaStream`

- Name: VideoBackgroundEffect
- Type: DWORD
- Value: 0 (disabled), 1 (enabled), 2 (background image replacement)

A value set to 1 blurs the background. The end-user or the administrator can set this value.

Value set to 2 also requires the **VideoBackgroundImage** key to be present as well. Only the administrator can set this value. The following key is required only if you want to replace the background image and not for blurring:

- Name: VideoBackgroundImage
- Type: REG_SZ
- Value: my_image_name.jpeg

The video background image must be present in the `C:\Program Files (x86)\Citrix\ICA Client` directory.

This registry configuration can also be used to enable background blurring or image replacement in Citrix Workspace app 2206 without the Microsoft Teams UI selector. In other words, if your environment or VDA doesn't support multi-window, you can still apply the HKCU registry workaround with Citrix Workspace app 2206 or higher to achieve a similar result, although the user cannot control the functionality in the middle of the HDX session or Microsoft Teams call.

Registry key changes only take effect when the HDX session connects.

On Mac User downloaded picture location: `/Users/username/Downloads/any_image.png`

Run the following commands to set the custom image as the default image:

```
defaults write com.citrix.HdxRtcEngine VideoBackgroundEffect -int 2
defaults write com.citrix.HdxRtcEngine VideoBackgroundImage -string "/Users/username/Downloads/any_image.png"
```

On Linux User downloaded picture location: `/home/username/Downloads/any_image.jpg`

Create the file `/var/.config/citrix/hdx_rtc_engine/config.json` and add the following configuration keys in JSON format. For example,

```
1 {
2
3
4 "VideoBackgroundEffect":2,
5
6 "VideoBackgroundImage":"/home/username/Downloads/any_image.jpg"
7
8 }
```

On HTML5

1. Navigate to the **configuration.js** file in the **HTML5Client** folder.
2. Add the **backgroundEffects** attribute and set the attribute to **true**. For example,

```
1 'features' : {
2
3   'msTeamsOptimization' :
4   {
5
6     'backgroundEffects' : true
7   }
8 }
```



```
9   }  
10  
11 <!--NeedCopy-->
```

3. Save the changes.

Client CPU Consumption considerations

While the blurring feature is frugal on the CPU, you can expect an increase in consumption. For example, on a thin client with a 4 Core, 1.5 GHz Intel® Pentium® Silver chip with TurboBoost up to 2.8 GHz, the background blurring adds about 2% to the CPU usage. Average CPU usage is less than 20%.

Gallery view and active speakers in Microsoft Teams

Microsoft Teams supports **Gallery**, **Large gallery**, and **Together mode** layouts.

Microsoft Teams displays a 2x2 grid with video streams of four participants (known as **Gallery**). In this case, Microsoft Teams sends four video streams to the client device for decoding. When more than four participants share a video, only the last four most active speakers appear on the screen.

Microsoft Teams also provides the large gallery view with a grid up to 7x7. As a result, the Microsoft Teams conference server composites a single video feed and sends it to the client device for decoding, resulting in lower CPU consumption. This single, matrix-style feed might include users' self-preview videos as well.

Lastly, Microsoft Teams supports **Together mode**, which is part of the new meeting experience. Using AI segmentation technology to digitally place participants in a shared background, Microsoft Teams puts all participants in the same auditorium.

The user can control these modes during a conference call by selecting **Gallery**, **Large gallery**, or **Together mode** layouts in the ellipses menu.

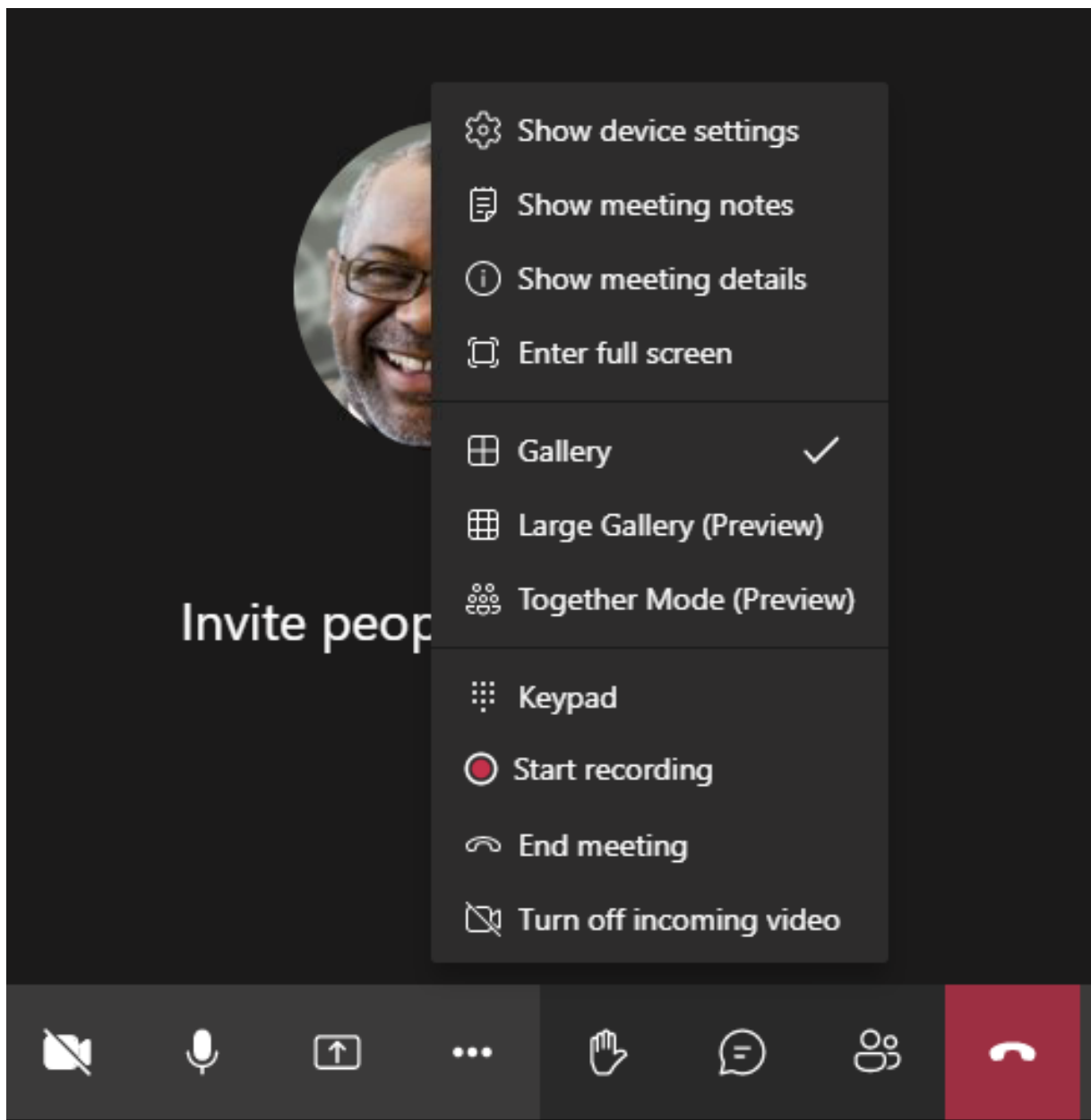

Support for video aspect ratio constraints (Citrix Workspace app for Windows 2102, Citrix Workspace app for Linux 2106, Citrix Workspace app for MAC 2106 and later):

- The option **Fill to frame** is available in Gallery/Large Gallery View. This option crops the video size to fit it in the subwindow. **Fit to frame**, on the other hand, displays black bars (letterbox) on the sides of the video so there is no cropping.

The following table provides a comparison of Gallery and Large Gallery layouts:

| | Gallery view 2x2 (default) | Large Gallery view |
|--------------------------|--|--|
| Layout / Grid | Displays a 2x2 grid with video streams of four participants. Only the last four most active speakers appear on the screen and other participants do not appear on the grid. | Displays a 7x7 grid with video streams of 49 participants. |
| Mixing technique | A media router forwards individual streams from each participant to every user. | A central conference server mixes and transcodes all audio or video to create a tailored composite layout for every participant. This action introduces some additional latency. |
| Active speaker | The new active speaker replaces the least active speaker in the grid. | Displays all participants irrespective of whether they are active or inactive. |
| Encoding at the endpoint | One or more video streams might be encoded at the endpoint if Simulcast is enabled. For more information on Simulcast support, see Simulcast. | One or more video streams might be encoded at the endpoint if Simulcast is enabled. For more information on Simulcast support, see Simulcast. |
| Decoding at the endpoint | Each participant gets up to four individual media streams. This increases CPU consumption at the endpoint by HdxRtcEngine.exe (for decoding/rendering). | Each participant gets only a single stream for audio and video. This setting lowers the CPU consumption at the endpoint. |
| Maximum resolution | 720p. When four participants are sharing video, the maximum resolution is 360p per video feed. If fewer than four participants are sharing video, the resolution per video feed might be higher. | 720p for the composite layout or mixing. There's no need for a high-quality video stream per participant in a composite layout. Because of this condition, each sender reduces resolution or upload bitrate. |

| | Gallery view 2x2 (default) | Large Gallery view |
|---------------------|--|--|
| ‘Slow-user’ problem | Sender modifies each modality’s (audio/video/screenshare) quality to the lowest common network quality among the participants. This multimedia stream is then forwarded to all other participants. As a result, a participant with poor network condition impacts the quality for everyone else in the call. | Less susceptible to the lowest common network quality scenario. The conference server provides different qualities based on the network conditions of individual participants. |
| Self-preview | Displays yourself in a small thumbnail in real time. | Displays yourself in thumbnail and mixed with the rest of the video feeds. As a result, you might see yourself included in the main video layout with some additional delay. |

Screen sharing in Microsoft Teams

Microsoft Teams relies on video-based screen sharing (VBSS), effectively encoding the desktop being shared with video codecs like H264 and creating a high-definition stream. With HDX optimization, incoming screen sharing is treated as a video stream.

Starting from Citrix Workspace app 2109 or higher for Windows, Linux, Mac, and Citrix Workspace app 2303 for ChromeOS users can share their screens and video camera simultaneously.

With earlier versions, if you’re in the middle of a video call and the other peer starts to share the desktop, the original camera video feed is paused. Instead, the screen sharing video feed shows. The peer must then manually resume the camera sharing.

Note for PowerPoint Live

This limitation does not exist if you’re sharing content from PowerPoint Live. In that case, other peers can still see your webcam and content and navigate back and forth to review other slides. In this scenario, the slides are rendered on the VDA. To access a PowerPoint Live slide deck, click the ‘Share tray’ button and select one of the suggested PowerPoint slides, or click ‘Browse’ and find a PowerPoint file on your computer or in OneDrive.

Outgoing screen sharing is also optimized and offloaded to Citrix Workspace app. In this case, the

media engine captures and transmits only the Citrix Desktop Viewer (CDViewer.exe) window, with a red border drawn around it. Any local application overlapping with Desktop Viewer isn't captured.

Note

Set specific permission in Citrix Workspace app for Mac to enable screen sharing. For more information, see [System Requirements](#).

Known limitation:

- If Desktop Viewer is disabled or if Desktop Lock is being used, multimonitor selection isn't available in the Microsoft Teams screen picker. The Desktop Viewer might be disabled either by editing the `.ICA` file template or `StoreFront web.config`. SHIFT+F2 hotkey isn't compatible with multimonitor screen sharing.
- In Workspace app versions older than 2106, only the primary monitor is shared. Drag the application in the virtual desktop to the primary monitor for the other peers on the call to see it.
- Multimonitor screen sharing might not work if you configure the Citrix Workspace app with the virtual monitor layout feature (logical partition of a single physical monitor). In this case, all virtual monitors are shared as a composite image.
- Older versions of the Citrix Workspace app for Windows (1907 up to 2008) also share a local application that runs in the client machine. This sharing is possible only if the local app is overlaid on top of the Desktop Viewer. This behavior was removed in 2009.6 or higher, and 1912 CU5 or higher.
- While screen sharing, if you change from windowed mode to full-screen, screen sharing stops. You must stop and share again for screen sharing to work.
- It is not possible to Pin the Sharing Controls to a specific location in Optimized Microsoft Teams.
- When sharing a minimized app, the title bar of the app might also be shared.

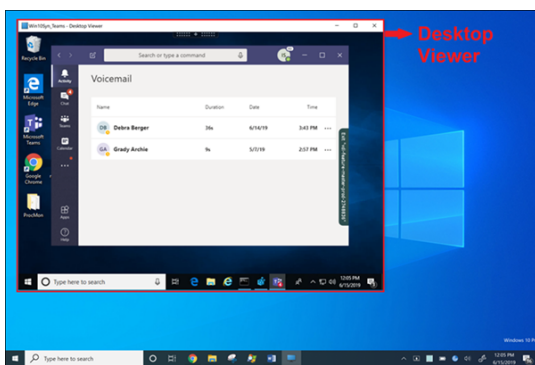

Screensharing from seamless application:

If you're publishing Microsoft Teams as a standalone, seamless application, screen sharing captures the local desktop of your physical endpoint. Citrix Workspace app minimum version 1909 is required.

App sharing

Starting with the Citrix Workspace app for Windows 2112.1 and VDA 2112, Microsoft Teams supports app sharing.

Starting with the Citrix Workspace app for Windows 2109, Mac 2203, Linux 2209 and VDA 2109, Microsoft Teams supports screen sharing of specific apps running in the virtual session. You can also share custom in-house applications, like Java, using the optimized Microsoft Teams. To share a specific app:

1. Navigate to the Microsoft Teams app within your remote session.
2. Click **Share content** in your Microsoft Teams UI.
3. Select an app to share in the meeting. The red border appears around an app that you selected and the peers on the call can see the shared app.

To share a different app, click **Share content** again and select a new app.

If you want to disable app sharing, create the following registry key on the VDA at [HKLM\SOFTWARE\Citrix\Graphics](#):

Name: [UseWsProvider](#)

Type: [DWORD](#)

Value: 0

Note:

- If you minimize an app, Microsoft Teams displays the last image from the shared app. You can maximize the window to resume screen sharing.
- Screen sharing depends on the VDA-side capturing of the window. The content is then relayed at a maximum rate to the Citrix Workspace app. The maximum rate is 30 frames per second. The Citrix Workspace app forwards the content to the peer or conference server.

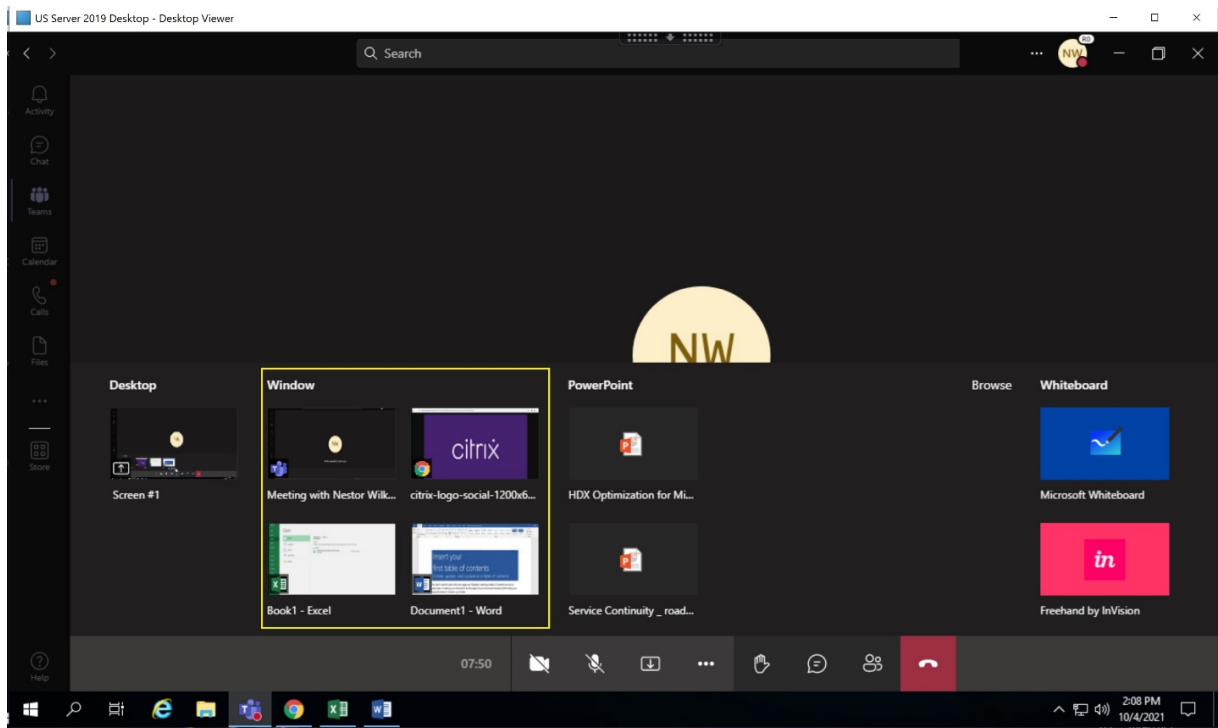

Known limitations with screen sharing of specific app:

- The mouse pointer isn't visible when you are screen-sharing an app.
- If you minimize an app when you're sharing it, only the app icon appears in the screen picker. The thumbnail of the app isn't previewed in the screen picker. You can't share the content and the red border does not appear until you maximize the app.
- LAA apps show a list of apps that can be shared with desktop apps in the optimized Microsoft Teams in the VDA. However, when you select the app from the list, the result might not be as expected.

Compatibility with app protection

The screen sharing of a specific app is compatible with the app protection feature in HDX optimized Microsoft Teams. You can screen share a specific app, if you've launched the app or desktop from a delivery group that has app protection enabled.

When you click **Share content** in the Microsoft Teams UI, the screen picker removes the **Desktop** option. You can only select the **Window** option to share any open app.

Note:

When you launch apps or desktops from a delivery group with app protection enabled, you aren't able to see the incoming video or screen sharing if you are using the Citrix Workspace app for Windows 2202 or earlier.

Give and Request control in Microsoft Teams This feature is supported in the following versions of the Citrix Workspace app (there is no dependency on the VDA version or Operative System, single session or multisession):

- Citrix Workspace app for Windows version 2112.1 or later
- Citrix Workspace app for Mac version 2203.1 or later
- Citrix Workspace app for Linux version 2203 or later
- Citrix Workspace app for ChromeOS version 2303 or later

You can request control during a Microsoft Teams call when a participant is sharing the screen. Once you have control, you can make selections, edits, or other keyboard and mouse activities to the shared screen.

To take control when a screen is being shared, click the **Request control** button in the Microsoft Teams UI. The meeting participant who's sharing the screen can either allow or deny your request.

While you have control, you can make selections, edits, and other modifications to the shared screen. For these actions, you can use both a keyboard and a mouse. When you're done, click **Request control**.

Limitations:

- Give and Request controls are not available if the user is sharing a single app (also known as App sharing). The full desktop or monitor must be shared.
- The feature to pin the control bar to a specific location is not available.

Peripherals in Microsoft Teams

When optimization for Microsoft Teams is active, the Citrix Workspace app accesses the peripherals (headsets, microphones, cameras, speakers, and so forth). Then the peripherals are properly listed in the Microsoft Teams UI (**Settings > Devices**).

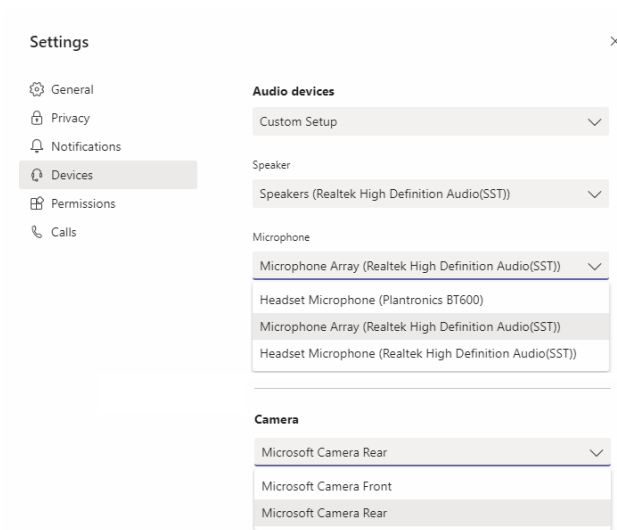

Microsoft Teams does not access the devices directly. Instead, it relies on the Workspace app WebRTC media engine for acquiring, capturing, and processing the media. Microsoft Teams lists the devices for the user to select.

The peripherals that are inserted while Microsoft Teams are active aren't selected by default. You've to manually select the peripherals from the **Settings > Devices** screen of the Microsoft Teams UI. After the peripheral is selected, Microsoft Teams caches the information of the peripherals. As a result, the peripherals are automatically selected when you reconnect to a session from the same endpoint.

Recommendations:

- Microsoft Teams certified headsets with built-in echo cancellation. In setups with extra peripherals, where the microphone and speakers are on separate devices, there might be an echo. An example is a webcam with a built-in microphone and a monitor with speakers. When using external speakers, place them as far as possible from the microphone. Also, place them away from any surface that might refract the sound into the microphone. For more information, go to www.microsoft.com and search for Microsoft Teams certified headsets.
- Microsoft Teams certified cameras, although Skype for Business certified peripherals are compatible with Microsoft Teams. For more information, go to and search for Microsoft Teams certified cameras and Skype for Business certified peripherals.
- Citrix Workspace app media engine can't take advantage of CPU offloading with webcams that perform on-board H.264 encoding -UVC 1.1 and 1.5.

Note:

Workspace app 2009.6 for Windows can now acquire peripherals with audio formats with 24-bit or with frequencies above 96 kHz.

HdxTeams.exe (in the Citrix Workspace app for Windows 2009 or older) supports only these spe-

cific audio device formats (channels, bit depth, and sample rate):

- Playback Devices: up to 2 channels, 16 bit, frequencies up to 96,000 Hz
- Recording Devices: up to 4 channels, 16 bit, frequencies up to 96,000 Hz

Even if one speaker or microphone does not match the expected settings, device enumeration in Microsoft Teams fails and **None** displays under **Settings > Devices**.

Webrpc logs in **HdxTeams.exe** show this type of information:

```
Mar 27 20:58:22.885 webrtcapi.WebRTCEngine Info: init. initializing  
...
```

```
Mar 27 20:58:23.190 webrtcapi.WebRTCEngine Error: init. couldn't  
create audio module!
```

As a workaround, disable the specific device or:

1. Open the **Sound Control Panel** (mmsys.cpl).
2. Select the playback or recording device.
3. Go to **Properties > Advanced** and change the settings to a supported mode.

Fallback mode

If Microsoft Teams fails to load in optimized VDI mode (“Citrix HDX Not Connected” in Microsoft Teams/About/Version), the VDA falls back to legacy HDX technologies. The legacy HDX technologies might be webcam redirection and client audio and microphone redirection. If you’re using a Workspace app version/platform OS that does not support Microsoft Teams optimization, fallback registry keys do not apply.

In fallback mode, the peripherals are mapped to the VDA. The peripherals appear to the Microsoft Teams app as if they were locally attached to the virtual desktop.

You can now granularly control the fallback mechanism by setting the registry keys in the VDA. For more information, see [Microsoft Teams fallback mode](#) in the list of features managed through the registry.

This feature requires Microsoft Teams version 1.3.0.13565 or later.

To determine if you are in optimized or unoptimized mode when looking at the **Settings > Devices** tab in the Microsoft Teams app, the main difference is the camera name. If Microsoft Teams is loaded in unoptimized mode, legacy HDX technologies launch. The webcam name has the **Citrix HDX** suffix as shown in the following graphic. The speaker and microphone device names might be slightly different (or truncated) when compared to the optimized mode.

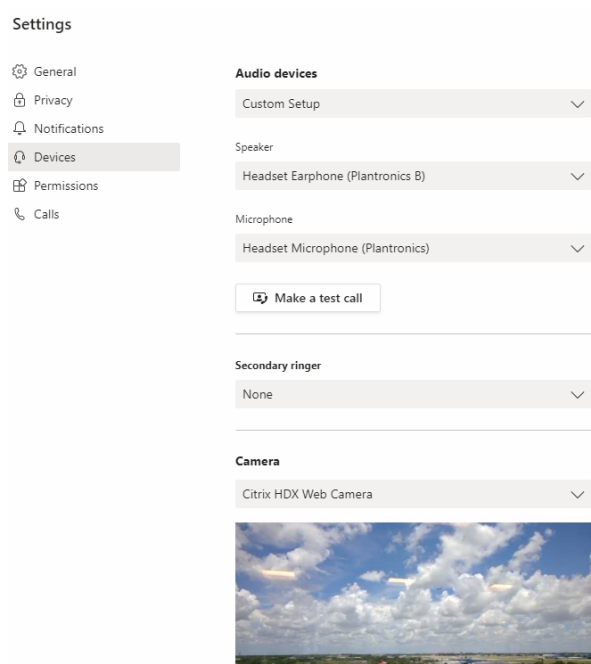

When legacy HDX technologies are used, Microsoft Teams doesn't offload audio, video, and screen-sharing processing to the endpoint's Citrix Workspace app WebRTC media engine. Instead, HDX technologies use server-side rendering. Expect high CPU consumption on the VDA when you turn on video. Real-time audio performance might not be optimal.

Known limitations

Citrix limitations

Limitations on Citrix Workspace app:

- HID buttons - Answer and end calls aren't supported. Volume up and down are supported.
- QoS settings in the Admin Center for Microsoft Teams don't apply for VDI users.
- Users can't take screenshots of Microsoft Teams content while using a snipping tool on the VDA. However, if a snipping tool is used on the client side, the content can be captured.

Limitation on the VDA:

- When you configure the **Citrix Workspace app High DPI** setting to **Yes**, the redirected video window appears out of place. This limitation occurs when the monitor's DPI scaling factor is set to anything above 100%.

Limitations on the Citrix Workspace app and the VDA:

- You can only control the volume of an optimized call using the volume bar on the client machine –not on the VDA.

Simulcast

Simulcast support is enabled for optimized Microsoft Teams video conference calls on Windows and Mac. For Linux check with your thin client vendor.

With Simulcast the quality and experience of video conference calls across different endpoints are improved by adapting to the proper resolution for the best call experience for all callers.

With this improved experience, each user might deliver multiple video streams in different resolutions (for example, 720p, 360p, and so on) depending on several factors including endpoint capability, network conditions, and so on. The receiving endpoint then requests the maximum quality resolution that it can handle thereby giving all users the optimum video experience.

Note:

This feature is available only after the roll-out of an update from Microsoft Teams. For information on ETA, go to <https://www.microsoft.com/> and search for Microsoft 365 roadmap. When the update is rolled-out by Microsoft, you can check [CTX253754](#) for the documentation update and the announcement.

Microsoft limitations

- A 3x3 gallery view isn't supported. Microsoft Teams dependency –contact Microsoft for when to expect a 3x3 grid.
- Interoperability with Skype for Business is limited to audio calls, no video modality.
- Incoming and outgoing video stream maximum resolution is 720p.
- PSTN call ringback tone isn't supported.
- Media bypass for Direct Routing isn't supported.
- Broadcast and live event producer and presenter roles aren't supported. Attendee role is supported but not optimized (renders on the VDA instead).
- The zoom in and zoom out function in Microsoft Teams isn't supported.
- Location-Based Routing and Media Bypass are not supported.
- Call merge is not supported (option not displayed in the user interface).

Citrix and Microsoft limitations

- When doing screen sharing, the **include system audio** option isn't available.
- Simulcast isn't supported on ChromeOS.

Upcoming Microsoft Teams Single-Window EOL

On January 31, 2024, Microsoft will retire the Microsoft Teams support for Single-window UI when using VDI Microsoft Teams optimization and support only the Multi-window experience. Microsoft gave notice of this deprecation on 9/8/2023 in the M365s Admin Center (Post ID: MC674419).

Public details about the Multi-window feature can be found in the Tech Community article: [New Meeting and Calling Experience in Microsoft Teams](#).

Note:

Citrix recommends you upgrade your VDA and Citrix Workspace app to the supported versions to continue using Microsoft Teams in optimized mode for video and screen sharing. If you don't upgrade your infrastructure and endpoints to support multi-window, your calls, video calls, and screen sharing become unoptimized. This may result in call quality issues, increased latency, and increased load on the server.

The following table illustrates the minimum, LTSR, and recommended versions of VDA and Citrix Workspace app required to continue using optimized calling in Microsoft Teams on Citrix VDI:

| Component | Minimum version (1) | LTSR supported version (2) | Recommended version (3) |
|--|-----------------------------------|-------------------------------|-------------------------|
| Microsoft Teams | 1.5.00.11865 | Not applicable | Latest |
| VDA | 1912 CU6 LTSR, 2109 CR, 2203 LTSR | 1912 CU8+, 2203 LTSR CU2+ (4) | 2308 CR+ |
| Citrix Workspace app for Windows | 2112.1 CR | 2203 CU2+ (4) | 2309 CR+ |
| Citrix Workspace app for Mac | 2203 CR | Not applicable | 2308 CR+ |
| Citrix Workspace app for Linux | 2202 CR | Not applicable | 2308 CR+ |
| Citrix Workspace app for ChromeOS or HTML5 | 2303 CR | Not applicable | 2309 CR+ |

Notes:

1. Minimum Version: This is the version where Multi-window was first introduced. Some minimum versions listed here can be end-of-life.
2. LTSR Supported Version: This is the LTSR version that is supported by Citrix for Multi-window. Older versions of these LTSR releases can work but support is no longer available for those versions once a new LTSR CU version is released. For more information on LTSR

- support policies, see <https://support.citrix.com/article/CTX205549/faq-citrix-virtual-apps-and-desktops-and-citrix-hypervisor-long-term-service-release-ltsr>.
3. Recommended Version: This is the version of software that Citrix recommends if the user/customer chooses to upgrade their software. These are all CR versions.
 4. Version 2203 LTSR for VDA and CWA base versions include the multi-window functionality. These versions have been superseded by the latest CU which is the officially supported version. Customers can continue to use these unsupported versions at their discretion. Citrix encourages customers on the LTSR release to upgrade to the latest CU.

Deprecation announcement of the SDP format (Plan B) from WebRTC

Citrix is planning to deprecate the current SDP format (Plan B) support from WebRTC in future releases. You must use Unified Plan in WebRTC to support optimized Microsoft Teams functionalities.

Products that are affected

In one of the future releases of the Citrix Workspace Application, calls between endpoints with the upcoming release for the Citrix Workspace app and endpoints with Citrix Workspace app 2108 or older versions will not be supported. This calling incompatibility includes 1912 LTSR Citrix Workspace app clients (CWA). The following CWA clients are impacted:

- Citrix Workspace app for Windows
- Citrix Workspace app for Linux
- Citrix Workspace app for Mac
- Citrix Workspace app for Chrome

Replacement for Plan B

If you are running the Citrix Workspace app version older than 2109, you must upgrade to a supported version (preferably the latest CR release). Otherwise, any calls with a future release or newer endpoints fail to connect. Calls between future releases and your federated communication partners might also fail to complete if the federated partner has not upgraded their Citrix Workspace.

Citrix Workspace app version 2108 has completed its support date in March 2023 and must be upgraded to a newer version. For more information, see [Workspace App](#) for details on Citrix Workspace app version support.

For more information on the Plan B deprecation, see the [WebRTC](#) documentation.

Additional information

- [Monitor, troubleshoot, and support Microsoft Teams](#)
- [Deploy the Microsoft Teams desktop app to the VM](#)
- [Install Microsoft Teams using MSI \(VDI Installation section\)](#)
- [Thin clients](#)
- [Skype for Business Network Assessment Tool](#)
- [Understand Microsoft Teams and Skype for Business coexistence and interoperability](#)

Monitor, troubleshoot, and support Microsoft Teams

December 6, 2023

Monitor Teams

This section provides guidelines for monitoring Microsoft Teams optimization with HDX. If you're running in optimized mode and `HdxRtcEngine.exe` is running on the client machine, a process on the VDA called `WebSocketAgent.exe` is running in the session. Use the **Activity Manager** in Director to see the application.

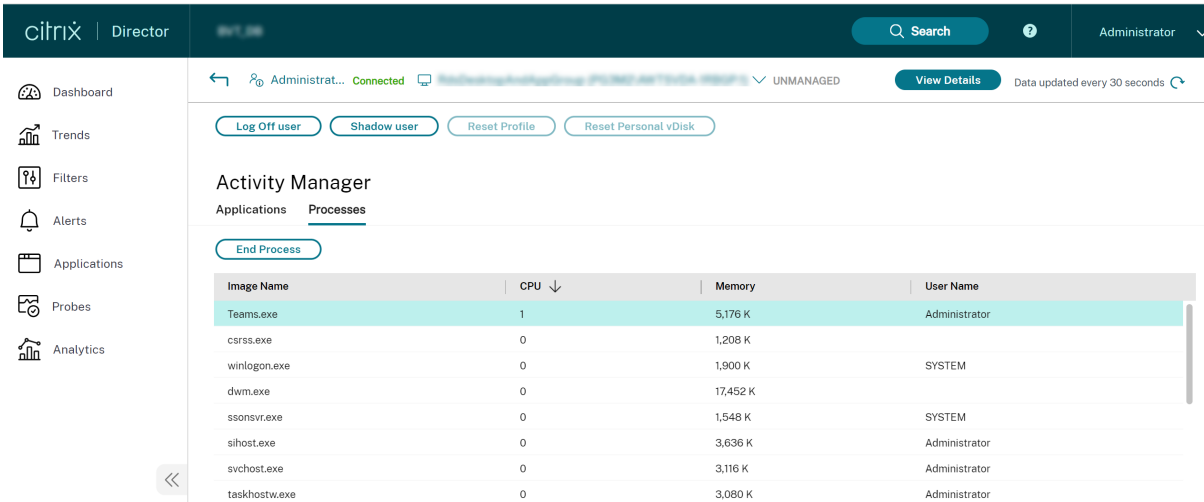

The screenshot shows the Citrix Director interface. The left sidebar contains navigation options: Dashboard, Trends, Filters, Alerts, Applications, Probes, and Analytics. The main content area is titled 'Activity Manager' and shows a table of running processes. The 'Processes' tab is selected, and an 'End Process' button is visible. The table lists the following processes:

| Image Name | CPU ↓ | Memory | User Name |
|---------------|-------|----------|---------------|
| Teams.exe | 1 | 5,176 K | Administrator |
| csrss.exe | 0 | 1,208 K | |
| winlogon.exe | 0 | 1,900 K | SYSTEM |
| dwm.exe | 0 | 17,452 K | |
| ssonsvr.exe | 0 | 1,548 K | SYSTEM |
| sihost.exe | 0 | 3,636 K | Administrator |
| svchost.exe | 0 | 3,116 K | Administrator |
| taskhostv.exe | 0 | 3,080 K | Administrator |

Microsoft Teams Optimization status can be viewed in the Director > **User Details** page > **Session Details** panel > **MS Teams Optimization** field. Microsoft Teams being optimized is critical for better user experience such as clear audio and video. This feature is available for VDA version 2311 and later. Citrix Workspace app versions supported are listed in Optimization for Microsoft Teams. Director displays the status of the Microsoft Teams optimization only if Microsoft Teams is running as a published

app or inside a published desktop.

For more information, see [Microsoft Teams optimization status](#).

With the VDA minimum version 1912, you can monitor active Teams calls using the Citrix HDX Monitor (minimum version 3.11). The Citrix Virtual Apps and Desktops product ISO contains the latest `hdxmonitor.msi` in the folder `layout\image-full\Support\HDX Monitor`.

With the VDA minimum version 1912, you can monitor active Microsoft Teams calls using the Citrix HDX Monitor (minimum version 3.11). The Citrix Virtual Apps and Desktops product ISO contains the latest `hdxmonitor.msi` in the folder `layout\image-full\Support\HDX Monitor`.

For more information, see *Monitoring* in the Knowledge Center article [CTX253754](#).

Troubleshoot

This section provides troubleshooting tips for issues that you might encounter when using optimization for Microsoft Teams. For more information, see [CTX253754](#).

On the Virtual Delivery Agent

There are four services installed by `BCR_x64.msi`. Only two are responsible for Microsoft Teams redirection in the VDA.

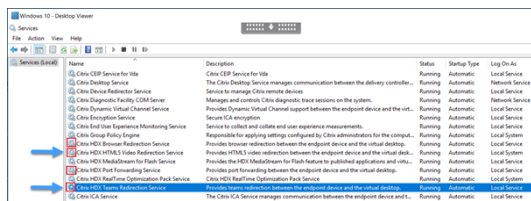

- **Citrix HDX Teams Redirection Service** establishes the virtual channel used in Microsoft Teams. The service relies on `CtxSvcHost.exe`.

- **Citrix HDX HTML5 Video Redirection Service** runs as `WebSocketService.exe` listening on `127.0.0.1:9002` TCP. `WebSocketService.exe` performs two main functions:

- TLS termination for secure WebSockets** receives a secure WebSocket connection from `vdicitrixpeerconnection.js`, which is a component inside the Microsoft Teams app. You can track it with the Process Monitor. For more information about certificates, see the section “TLS and HTML5 video redirection, and browser content redirection” under [Communication between Controller and VDA](#).

Some antivirus and desktop security software interferes with the proper functioning of `WebSocketService.exe` and its certificates. While the Citrix HDX HTML5 Video Redirection service might be running in the `services.msc` console, the `localhost 127.0.0.1:9002` TCP socket is never in listening mode as seen in `netstat`. Trying to restart the service causes it

to hang (“Stopping...”). Ensure you apply the proper exclusions for the `WebSocketService.exe` process.



ii. **User session mapping.** When the Microsoft Teams application starts, `WebSocketService.exe` starts the `WebSocketAgent.exe` process in the user’s session in the VDA. `WebSocketService.exe` runs in Session 0 as a `LocalSystem` account.

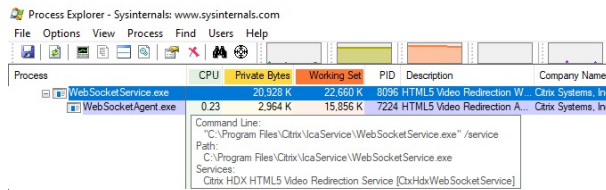

You can use `netstat` to check if the `WebSocketService.exe` service is in an active listening state in the VDA.

Run `netstat -anob -p tcp` from an elevated command prompt window:

```
TCP 127.0.0.1:9001 0.0.0.0:0 LISTENING 11740
[WebSocketService.exe]
TCP 127.0.0.1:9002 0.0.0.0:0 LISTENING 11740
[WebSocketService.exe]
```

On a successful connection, the state changes to ESTABLISHED:

```
TCP 127.0.0.1:9002 127.0.0.1:58069 ESTABLISHED 8096
[WebSocketService.exe]
TCP 127.0.0.1:58069 127.0.0.1:9002 ESTABLISHED 748
[Teams.exe]
```

Important:

`WebSocketService.exe` listens in two TCP sockets, 127.0.0.1:9001 and 127.0.0.1:9002. Port 9001 is used for browser content redirection and HTML5 video redirection. Port 9002 is used for Microsoft Teams redirection. Ensure that you don’t have any proxy configurations in the Windows OS of the VDA that can prevent a direct communication between `Teams.exe` and `WebSocketService.exe`. Sometimes, when you configure an explicit proxy in Internet Explorer 11 (**Internet Options > Connections > LAN settings > Proxy Server**), connections might flow through an assigned proxy server. Verify that **Bypass proxy server for local addresses** is checked when using a manual and explicit proxy setting.

Services locations and descriptions

| Service | Path to executable in Windows Server OS | Log on as | Description |
|--|--|------------------------------------|---|
| Citrix HTML5 Video Redirection Service | “C:\Program Files (x86)\Citrix\System32\WebSocketService.exe”
/service | Local System account | Provides multiple HDX Multimedia services with the initial framework required to perform media redirection between the virtual desktop and the endpoint device. |
| Citrix HDX Browser Redirection Service | “C:\Program Files (x86)\Citrix\System32\CtxSvcHost.exe”
-g BrowserRedirSvcs | This account (local Security Host) | Provides browser content redirection between the endpoint device and the virtual desktop. |
| Citrix Port Forwarding Service | “C:\Program Files (x86)\Citrix\System32\CtxSvcHost.exe”
-g PortFwdSvcs | This account (local Security Host) | Provides port forwarding between the endpoint device and the virtual desktop for browser content redirection. |
| Citrix HDX Teams Redirection Service | “C:\Program Files (x86)\Citrix\System32\CtxSvcHost.exe”
-g TeamsSvcs | Local System account | Provides Microsoft Teams redirection between the endpoint device and the virtual desktop. |

Citrix Workspace app

On the user’s endpoint, the Citrix Workspace app for Windows instantiates a new service called HdxTeams.exe or HdxRtcEngine.exe. It does so when Microsoft Teams launches in the VDA and the user tries to call or access the peripherals in self-preview. If you don’t see this service, check the following:

1. Ensure that you installed as a minimum the Workspace App version 1905 for Windows. Do you see HdxTeams.exe or HdxRtcEngine.exe and the webrpc.dll binaries in the Workspace app installation path?

2. If you validated step1, do the following to check if HdxTeams.exe or HdxRtcEngine.exe is getting launched.
 - a) Exit Microsoft Teams on the VDA.
 - b) Start services.msc on VDA.
 - c) Stop the Citrix HDX Teams Redirection Service.
 - d) Disconnect the ICA session.
 - e) Connect the ICA session.
 - f) Start the Citrix HDX Teams Redirection Service.
 - g) Restart the Citrix HDX HTML5 Video Redirection Service.
 - h) Launch Microsoft Teams on the VDA.

3. If you still don't see HdxTeams.exe or HdxRtcEngine.exe being launched on the client endpoint, do the following:
 - a) Restart the VDA.
 - b) Restart the client endpoint.

Support

Citrix and Microsoft jointly support the delivery of Microsoft Teams from Citrix Virtual Apps and Desktops using optimization for Microsoft Teams. This joint support is the result of close collaboration between the two companies. If you have valid support contracts and you experience an issue with this solution, open a support ticket with the vendor whose code you suspect to be causing the issue. That is, Microsoft for Teams or Citrix for the optimization components.

Citrix or Microsoft receives the ticket, triages the issue, and escalates as appropriate. There is no need for you to contact each company's support team.

When you have a problem, we recommend you click **Help > Report a Problem** in the Teams UI. VDA-side logs are automatically shared between Citrix and Microsoft to resolve technical issues faster.

Collecting logs

HDX media engine logs can be found on the user's machine (not on the VDA). In case of any issues, make sure you attach logs to your support case.

Windows logs:

You can locate Windows logs at %TEMP% inside the **HDXTeams** folder (AppData/Local/Temp/HDX-Teams or AppData/Local/Temp/HdxRtcEngine). Look for a .txt file called webrpc_Day_Month_timestamp_Year.txt. If you are using newer versions of Citrix Workspace app, for example Citrix Workspace app 2009.5 or later, store the logs in AppData\Local\Temp\HdxRtcEngine.

Each session creates a separate folder for logs.

Mac logs:

1. VDWEBRTC log - records the execution of the virtual channel.

Location: /Users/<User Name>/Library/Logs/Citrix Workspace/CitrixViewer_<Y_M_D_H_M_S>.txt

2. HdxRtcEngine log - records the execution of the processes on HdxRtcEngine.

Location: \$TMPDIR/hdxrtcengine/<W_M_D_H_M_S_Y>/hdxrtcengine.log

HdxRtcEngine log is enabled by default.

3. Webrpc logs - are the most important logs that record the execution of the wrap-up of the webrtc library.

Location: /Users/<USERNAME>/Library/Logs/HdxRtcEngine/<W_M_D_H_M_S_Y>/webrpc.log

Linux logs:

You can locate Linux logs in the /tmp/webrpc/<current date>/ and /tmp/hdxrtcengine/<current date>/ folders.

Webrtc log: /tmp/webrpc/<current date>/webrtc.log

Kernel log: /var/log/syslog

ICE/STUN/TURN/ logs:

When establishing a call, these four ICE phases are required:

- Candidate gathering
- candidate exchange
- Connectivity checks (STUN bind requests)
- Candidate promotion

In the HdxRtcEngine.exe logs, the following entries are the relevant Interactive Connectivity Establishment (ICE) entries. These entries must be there for a call set-up to succeed. See the following sample snippet for the gathering stage:

```
1  RPCStubs Info: -> device id = \\?\display#int3470#4&1835d135&0&uid13424
   #{
2  65e8773d-8f56-11d0-a3b9-00a0c9223196 }
3  \{
4  bf89b5a5-61f7-4127-a279-e187013d7caf }
5  label = Microsoft Camera Front groupId =
6
7  webrtcapi.RTCPeerConnection Info: createOffer. audio = 1 video = 1
8  webrtcapi.RTCPeerConnection Info: setLocalDescription.
9  >>> begin:sdp
```

```
10 [...]
11
12 webrtcapi.RTCPeerConnection Info: OnSignalingChange. signaling state =
    HaveLocalOffer
13
14 webrtcapi.RTCPeerConnection Info: OnIceGatheringChange. state =
    Gathering
15
16 [...]
17 >>> begin:sdp
18 candidate:840548147 1 udp 2122194687 10.108.124.215 56927 typ host
    generation 0 ufrag oVk6 network-id 1
19 <<< end:sdp
20 [...]
21 >>> begin:sdp
22 candidate:1938109490 1 udp 24911871 52.114.xxx.xxx 52786 typ relay
    raddr 73.205.xxx.x rport 25651 generation 0 ufrag dDML network-id 1
    network-cost 10
23 <<< end:sdp
24 [...]
25 >>> begin:sdp
26 candidate:4271145120 1 udp 1685987071 66.xxx.xxx.xxx 55839 typ srflx
    raddr 10.108.124.215 rport 55839 generation 0 ufrag uAVH network-id
    1
27 <<< end:sdp
28 [...]
29
30 webrtcapi.RTCPeerConnection Info: OnIceGatheringChange. state =
    Complete webrtcapi.RTCPeerConnection Info: setRemoteDescription.
31 >>> begin:sdp
32 [...]
33
34 webrtcapi.RTCPeerConnection Info: OnSignalingChange. signaling state =
    HaveRemoteOffer
35
36 <!--NeedCopy-->
```

If there are multiple ICE candidates, the order of preference is:

1. host
2. peer reflexive
3. server reflexive
4. transport relay

If you encounter an issue and can reproduce it consistently, we recommend that you click **Help > Report a problem** in Microsoft Teams. Logs are shared between Citrix and Microsoft to resolve technical issues if you opened a case with Microsoft.

Capturing CDF traces before contacting Citrix Support is also beneficial. For more information, see the Knowledge Center article [CDFcontrol](#).

For recommendations for collecting CDF Traces, see the Knowledge Center article [Recommendations](#)

for Collecting the CDF Traces.

VDA side CDF traces - Enable the following CDF trace providers:

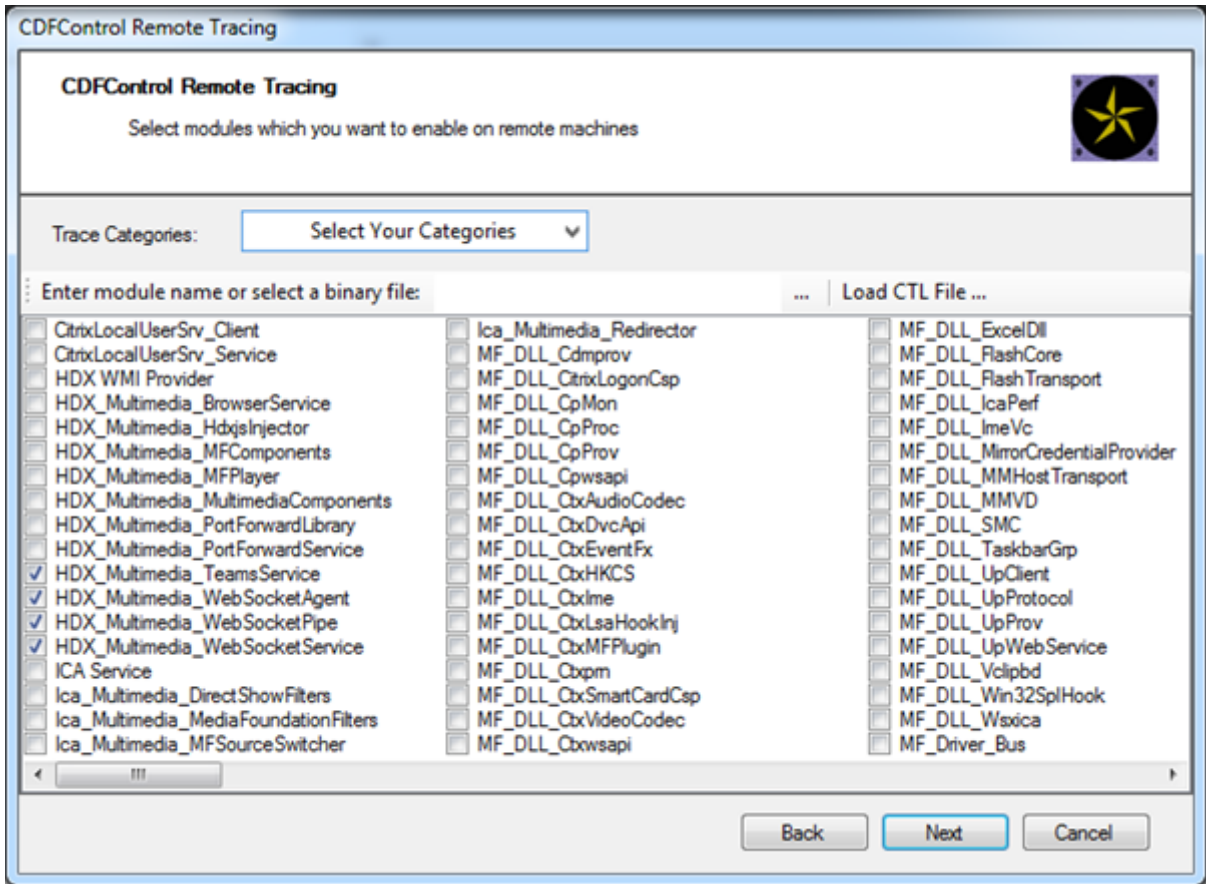

Workspace app side CDF traces - Enable the following CDF trace providers:

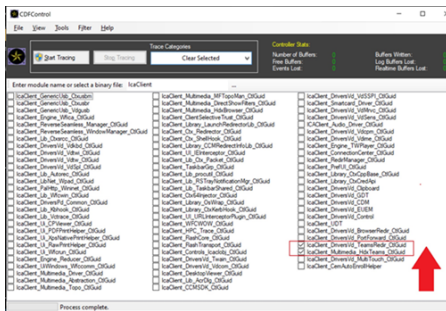

- IcaClient_DriversVd_TeamsRedir (optional)
- IcaClient_Multimedia_HdxTeams (requires Citrix Workspace app 2012 or later)

Windows Media redirection

December 18, 2019

Windows Media redirection controls and optimizes the way servers deliver streaming audio and video to users. By playing the media run-time files on the client device rather than the server, Windows Media redirection reduces the bandwidth requirements for playing multimedia files. Windows Media redirection improves the performance of Windows Media Player and compatible players running on virtual Windows desktops.

If the requirements for Windows Media client-side content fetching are not met, media delivery automatically uses server-side fetching. This method is transparent to users. You can use the Citrix Scout to perform a Citrix Diagnosis Facility (CDF) trace from HostMMTransport.dll to determine the method used. For more information see, [Citrix Scout](#).

Windows Media redirection intercepts the media pipeline at the host server, captures the media data in its native compressed format, and redirects the content to the client device. The client device then recreates the media pipeline to decompress and render the media data received from the host server. Windows Media redirection works well on client devices running a Windows operating system. Those devices have the multimedia framework required to rebuild the media pipeline as it existed on the host server. Linux clients use similar open-source media frameworks to rebuild the media pipeline.

The policy setting **Windows Media Redirection** controls this feature and is **Allowed** by default. Usually, this setting increases audio and video quality rendered from the server to a level that is comparable to content played locally on a client device. In the rare cases, media playing using Windows Media redirection appears worse than media rendered using basic ICA compression and regular audio. You can disable this feature by adding the **Windows Media Redirection** setting to a policy and setting its value to **Prohibited**.

For more information about the policy settings, see [Multimedia policy settings](#).

Limitation:

When you're using Windows Media Player and Remote Audio & Video Extensions (RAVE) enabled inside a session, a black screen might appear. This black screen might appear if you right-click on the video content and select **Always show Now Playing on top**.

General content redirection

February 5, 2024

Content redirection allows you to control whether users access information by using applications published on servers or by using applications running locally on user devices.

Client folder redirection

Client folder redirection changes the way client-side files are accessible on the host-side session.

- When you enable only client drive mapping on the server, client-side full volumes are automatically mapped to the sessions as Universal Naming Convention (UNC) links.
- When you enable client folder redirection on the server and the user configures it on the Windows desktop device, the portion of the local volume specified by the user is redirected.

Host to client redirection

Consider using host to client redirection for specific uncommon use cases. Normally, other forms of content redirection might be better. We support this type of redirection only on Multi-session OS VDAs and not on Single-session OS VDAs.

Local App Access and URL redirection

Local App Access seamlessly integrates locally installed Windows applications in to a hosted desktop environment. It does so without changing from one computer to another.

HDX technology provides **generic USB redirection** for specialty devices that don't have any optimized support or where it is unsuitable.

Client folder redirection

May 12, 2022

Client folder redirection changes the way client-side files are accessible on the host-side session. If you enable only client drive mapping on the server, client-side full volumes are automatically mapped as Universal Naming Convention (UNC) links to the sessions. When you enable client folder redirection on the server and the user configures it on the user device, the portion of the local volume specified by the user is redirected.

Only the user-specified folders appear as UNC links inside sessions. That is, instead of the complete file system on the user device. If you disable UNC links through the registry, client folders appear as mapped drives inside the session.

Client folder redirection is supported on Windows Single-session OS machines only.

Client folder redirection for an external USB drive is not saved on detaching and reattaching the device.

Enable client folder redirection on the server. Then, on the client device, specify which folders to redirect. The application you use to specify the client folder options is included with the Citrix Workspace app supplied with this release.

Requirements:

For servers:

- Windows Server 2022
- Windows Server 2019, Standard and Datacenter Editions
- Windows Server 2016, Standard and Datacenter Editions
- Windows Server 2012 R2, Standard and Datacenter Editions

For Clients:

- Windows 10, 32-bit and 64-bit editions (minimum version 1607)
- Windows 8.1, 32-bit and 64-bit editions (including Embedded edition)
- Windows 7, 32-bit and 64-bit editions (including Embedded edition)

To enable client folder redirection on the server, see [Client folder redirection](#) in the list of features managed through the registry.

On the user device, specify which folders to redirect:

1. Ensure that the latest version of Citrix Workspace app is installed.
2. From the Citrix Workspace app installation directory, start CtxCFRUI.exe.
3. Choose the **Custom** radio button and add, edit, or remove folders.
4. Disconnect and reconnect your sessions for the setting to take effect.

Client location redirection

November 20, 2023

Client location redirection, when enabled, allows VDA-hosted apps and desktop sessions to seamlessly access the client's current location. On a multi-session operating system (TS VDA or Multi-Session WS VDA), each session has its own unique location provided by the connected client. Using this feature, applications on the VDA that depend on location have the accurate location of the client.

For more information, see the [Microsoft](#) documentation.

After client location redirection is enabled and location access is allowed on both the server and client side, when you launch a location-accessing application or desktop, the client prompts you to share its current location with the following dialog box:

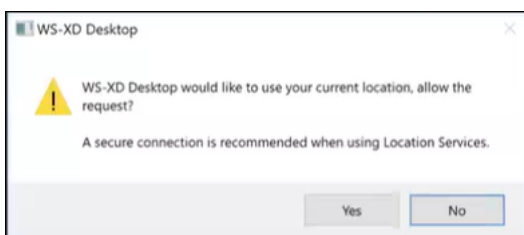

When you enable the client location redirection, the following icon appears in the client's taskbar if/when the VDA-hosted app or desktop queries current location information.

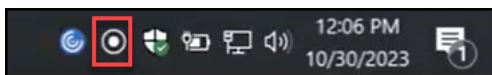

System requirements

For servers:

- Single-Session (Win10/11) or Multi-Session (Win 11 22H2 and Server 2022 23H2 or later) OS VDA
- Citrix Workspace app for Windows, iOS, or Android

Configuration

Client location redirection must be enabled using the Citrix policy for the feature to work. Client location redirection is disabled by default.

To enable client location redirection, complete the following steps:

On the Windows VDA and Client side:

1. In **Settings > Privacy > Location**, enable the following options:

- **Allow access to location on this device**
- **Allow apps to access your location**

- **Allow desktop apps to access your location**

2. For multi-session OS, enable the **Location Override** setting.

On the Controller/DDC side:

Enable the **Studio > Policies > Location > Settings > Allow application to use the physical location of the client device** policy.

For more information, see [Client sensors policy settings](#).

Bidirectional content redirection

April 11, 2024

Bidirectional content redirection allows HTTP or HTTPS URLs in web browsers, or embedded into applications, to be forwarded between the Citrix VDA session and the client endpoint in both directions. A URL entered in a browser running in the Citrix session can be opened using the client's default browser. Conversely, a URL entered in a browser running on the client can be opened in a Citrix session, either with a published application or desktop. Some common use cases for bidirectional content redirection include:

- Redirection of web URLs in cases where the starting browser does not have network access to the source.
- Redirection of web URLs for browser compatibility and security reasons.
- Redirection of web URLs embedded in applications when running a web browser on the Citrix session or the client isn't wanted.

System requirements

- Single-session or multi-session OS VDAs
- Citrix Workspace app for Windows

Browsers:

- Google Chrome with Citrix Browser Redirection Extension (available on the Google Chrome Web Store)
- Microsoft Edge (Chromium) with Citrix Browser Redirection Extension (available on the Google Chrome Web Store)

Configuration

Starting in Citrix Virtual Apps and Desktops version 2311, bidirectional content redirection is configured through Citrix Studio only. Prior releases had policy settings configured on both the client endpoint and Studio. Bidirectional content redirection is disabled by default.

For VDA configuration, see [Bidirectional content redirection](#) in the **ICA policy** settings.

For browser redirection to work, browser extensions must be registered on the originating browser (where the URL is redirected from) using the commands shown. Run the commands as needed on the VDA and client, based on the browser in use.

| Browser | VDA | Client |
|------------------------|---|-------------------------------------|
| Google Chrome | %ProgramFiles(x86)%\Citrix\HDX\%ProgramFiles(x86)%\Citrix\ICA
/regChrome | Client\redirector.exe
/regChrome |
| Microsoft Edge | %ProgramFiles(x86)%\Citrix\HDX\%ProgramFiles(x86)%\Citrix\ICA
/regEdge | Client\redirector.exe /regEdge |
| All Available Browsers | %ProgramFiles(x86)%\Citrix\HDX\%ProgramFiles(x86)%\Citrix\ICA
/regall | Client\redirector.exe /regall |

To unregister a browser extension:

| Browser | VDA | Client |
|------------------------|---|---------------------------------------|
| Google Chrome | %ProgramFiles(x86)%\Citrix\HDX\%ProgramFiles(x86)%\Citrix\ICA
/unregChrome | Client\redirector.exe
/unregChrome |
| Microsoft Edge | %ProgramFiles(x86)%\Citrix\HDX\%ProgramFiles(x86)%\Citrix\ICA
/unregEdge | Client\redirector.exe
/unregEdge |
| All Available Browsers | %ProgramFiles(x86)%\Citrix\HDX\%ProgramFiles(x86)%\Citrix\ICA
/unregall | Client\redirector.exe /unregall |

Note:

The register command causes Chrome and Edge browsers to prompt users to enable the Citrix Browser Redirection Extension during first launch. The browser extension can also be installed manually from the Google Chrome Web Store. For Microsoft Edge, also see [Add an extension to Microsoft Edge from the Chrome Web Store](#).

Wildcard redirection from Citrix VDA to client

Bidirectional content redirection supports the use of wildcards when defining the URLs to be redirected. To configure bidirectional content redirection, see the [configuration](#) instructions.

Custom protocol redirection from VDA to client

Bidirectional content redirection supports redirecting custom protocols from the Citrix VDA to the client. Protocols other than HTTP or HTTPS are supported. To configure bidirectional content redirection, see the [configuration](#) instructions.

In Web Studio, set the custom protocol in **Bidirectional content redirection**.

Note:

- You must have administrator privileges to run these commands.
- The client must have an application registered to handle the protocol. Otherwise, the URL redirects to the client and fails to launch.
- Custom protocol URLs that you enter or launch in the Chrome and Edge browsers are not supported and not redirected.
- The following protocols are not supported: `rtsp://`, `rtspu://`, `pnm://`, `mms://`.

Other considerations

- Browser requirements and configurations are only applicable to the browser starting the redirection. The destination browser, where the URL opens after redirection is successful, isn't considered for support. When redirecting URLs from the VDA to a client, a supported browser configuration is only required on the VDA. Conversely, when redirecting URLs from the client to a VDA, a supported browser configuration is only required on the client. Redirected URLs are handed off to the default browser configured on the destination machine, either the client or the VDA, depending on direction. Using the same browser type on the VDA and the client is not required.
- Check that redirection rules do not result in a looping configuration. For example, a VDA policy is set to redirect `https://www.citrix.com`, and the client policy is set to redirect the same URL, resulting in infinite looping.
- URL shorteners aren't supported.
- Client-to-VDA redirection requires the Windows client to be installed with administrator rights.
- If the destination browser is already open, the redirected URL opens in a new tab. Otherwise, the URL opens in a new browser window.
- Bidirectional content redirection does not work when Local App Access (LAA) is enabled.

Host to client redirection

April 11, 2024

Host-to-client redirection allows URLs, embedded as hyperlinks in applications running on a Citrix session, to open using the corresponding application on the user endpoint device. Some common use cases for host-to-client redirection include:

- Redirection of websites in cases where the Citrix server doesn't have Internet or network access to the source.
- Redirection of websites when running a web browser inside the Citrix session is not desired for security, performance, compatibility, or scalability reasons.
- Redirection of specific URL types in cases where the required applications to open the URL are not installed on the Citrix server.

Host-to-client redirection is not intended for URLs that you access on a webpage or type in the address bar of the web browser running in the Citrix session. For redirection of URLs in web browsers, see [Bidirectional URL redirection](#) or [Browser content redirection](#).

System requirements

- Multi-session OS VDA
- Supported clients:
 - Citrix Workspace app for Windows
 - Citrix Workspace app for Mac
 - Citrix Workspace app for Linux
 - Citrix Workspace app for HTML5
 - Citrix Workspace app for Chrome

The client device must have an application installed and configured for handling the redirection of the URL types.

Configuration

Use the [Host to client redirection](#) Citrix policy to enable this functionality. **Host to client redirection** is disabled by default. After you enable the Host-to-client redirection policy, the Citrix Launcher application registers with the Windows server to ensure that it can intercept URLs and send them to the client device.

Then you must configure the Windows Group Policy to use Citrix Launcher as the default application for the required URL types. On the Citrix server VDA, create the `ServerFTAdefaultPolicy.xml` file and insert the following XML code.

```
1 <?xml version="1.0" encoding="UTF-8"?>
2
3 <DefaultAssociations>
4
5 <Association Identifier="http" ProgId="ServerFTAHTML" ApplicationName="
   ServerFTA" />
6
```

```
7 <Association Identifier="https" ProgId="ServerFTAHTML" ApplicationName="
  "ServerFTA" />
8
9 </DefaultAssociations>
10 <!--NeedCopy-->
```

From the Group Policy management console, go to **Computer configuration > Administrative Templates > Windows Components > File Explorer > Set a default associations configuration file**, and save your ServerFTAdefaultPolicy.xml file.

Note:

If a Citrix server doesn't have the Group Policy settings, Windows prompts users to select an application for opening URLs.

By default, we support redirection of the following URL types:

- HTTP
- HTTPS
- RTSP
- RTSPU
- PNM
- MMS

To include additional standard or custom URL types on the list for redirection, create a new **Association Identifier** line in the ServerFTAdefaultPolicy.xml file referenced earlier. For example:

```
<Association Identifier="ftp"ProgId="ServerFTAHTML"ApplicationName="
ServerFTA"/>
```

```
<Association Identifier="mailto"ProgId="ServerFTAHTML"ApplicationName
="ServerFTA"/>
```

```
<Association Identifier="customtype1"ProgId="ServerFTAHTML"ApplicationName
="ServerFTA"/>
```

```
<Association Identifier="customtype2"ProgId="ServerFTAHTML"ApplicationName
="ServerFTA"/>
```

Adding URL types to the list also requires client configuration. Create the following registry key and values on the Windows client.

Note:

Editing the registry incorrectly can cause serious problems that might require you to reinstall your operating system. Citrix cannot guarantee that problems resulting from the incorrect use

of Registry Editor can be solved. Use Registry Editor at your own risk. Be sure to back up the registry before you edit it.

- Key: HKEY_LOCAL_MACHINE\SOFTWARE\Wow6432Node\Policies\Citrix\ICA Client\SFTA
- Value name: ExtraURLProtocols
- Value type: REG_SZ
- Value data: Specify the required URL types separated by semicolon. Include everything before the authority portion of the URL. For example:

```
ftp://;mailto;;customtype1://;customtype2://
```

You can add URL types only for Windows clients. Clients missing the registry settings above reject redirection back to the Citrix session. The client must have an application installed and configured to handle the specified URL types.

To remove URL types from the default redirection list, create the following registry key and values on the server VDA.

- Key: HKEY_LOCAL_MACHINE\SOFTWARE\Wow6432Node\Citrix\SFTA
- Value name: DisableServerFTA
- Value type: DWORD
- Value data: 1
- Value name: NoRedirectClasses
- Value type: REG_MULTI_SZ
- Value data: Specify any combination of the values: [http](#), [https](#), [rtsp](#), [rtspu](#), [pnm](#), or [mms](#). Type multiple values on separate lines. For example:

```
http
```

```
https
```

```
rtsp
```

To enable host-to-client redirection for a specific set of websites, create a registry key and values on the server VDA.

- Key: HKEY_LOCAL_MACHINE\SOFTWARE\Wow6432Node\Citrix\SFTA
- Value name: ValidSites
- Value type: REG_MULTI_SZ
- Value data: Specify any combination of fully qualified domain names (FQDNs). Type multiple FQDNs on separate lines. Include the FQDN only, without protocols ([http://](#) or [https://](#)). An FQDN can include an asterisk (*) as a wildcard character in the leftmost position only. This wildcard matches a single level of domain, which is consistent with the rules in RFC 6125. For example:

www.exmaple.com

*.example.com

Note:

You cannot use the **ValidSites** key with the **DisableServerFTA** and **NoRedirectClasses** keys.

Server VDA default browser configuration

Enabling host-to-client redirection as referenced in this section supersedes any previous default browser configuration on the server VDA. If a web URL is not redirected, the Citrix Launcher passes the URL to the browser configured in the `command_backup` registry key. The key points to Internet Explorer by default, but you can modify it to include the path to a different browser. For more information, see [Server VDA default browser configuration](#) in the list of features managed through the registry.

Local App Access and URL redirection

March 8, 2023

Introduction

Local App Access seamlessly integrates locally installed Windows applications into a hosted desktop environment without switching from one desktop to another. With Local App Access, you can:

- Access applications installed locally on a physical laptop, PC, or other device directly from the virtual desktop.
- Provide a flexible application delivery solution. If users have local applications that you cannot virtualize or that IT does not maintain, those applications still behave as though they are installed on a virtual desktop.
- Eliminate the double-hop latency when applications are hosted separately from the virtual desktop. Do so by putting a shortcut to the published application on the user's Windows device.
- Use applications such as:
 - Video conferencing software such as GoToMeeting.
 - Specialty or niche applications that are not yet virtualized.

- Applications and peripherals that would otherwise transfer large amounts of data from a user device to a server and back to the user device. For example, DVD burners and TV tuners.

In Citrix Virtual Apps and Desktops, hosted desktop sessions use URL redirection to start Local App Access applications. URL redirection makes the application available under more than one URL address. It launches a local browser (based on the browser's URL block list) by selecting embedded links within a browser in a desktop session. If you navigate to a URL that is not present in the block list, the URL is opened in the desktop session again.

URL redirection works only for desktop sessions, not application sessions. The only redirection feature you can use for application sessions is host-to-client content redirection, which is a type of server FTA (File Type Association) redirection. This FTA redirects certain protocols to the client, such as HTTP, HTTPS, RTSP, or MMS. For example, if you only open embedded links with HTTP, the links directly open with the client application. There is no URL block list or allow list support.

When Local App Access is enabled, URLs that are displayed to users as links from locally running applications, from user-hosted applications, or as shortcuts on the desktop are redirected in one of the following ways:

- From the user's computer to the hosted desktop
- From the Citrix Virtual Apps and Desktops server to the user's computer
- Rendered in the environment in which they are started (not redirected)

To specify the redirection path of content from specific websites, configure the URL allow list and URL block list on the Virtual Delivery Agent. Those lists contain multi-string registry keys that specify the URL redirection policy settings. For more information, see the [Local App Access policy settings](#).

URLs can be rendered on the VDA with the following exceptions:

- Geo/Locale information —Websites that require locale information, such as msn.com or news.google.com (opens a country specific page based on the Geo). For example, if the VDA is provisioned from a data center in the UK and the client is connecting from India, the user expects to see in.msn.com. Instead, the user sees uk.msn.com.
- Multimedia content —Websites containing rich media content, when rendered on the client device, give the end users a native experience and also save bandwidth even in high latency networks. This feature redirects sites with other media types such as Silverlight. This process is in a secure environment. That is, the URLs that the administrator approves are run on the client while the rest of the URLs are redirected to the VDA.

In addition to URL redirection, you can use FTA redirection. FTA starts local applications when a file is encountered in the session. If the local app is started, the local app must have access to the file to open it. Therefore, you can only open files that reside on network shares or on client drives (using client drive mapping) using local applications. For example, when opening a PDF file, if a PDF reader

is a local app, then the file opens using that PDF reader. Because the local app can access the file directly, there is no network transfer of the file through ICA to open the file.

Requirements, considerations, and limitations

We support Local App Access on the valid operating systems for VDAs for Windows Multi-session OS and for VDAs for Windows Single-session OS. Local App Access requires Citrix Workspace app for Windows version 4.1 (minimum). The following browsers are supported:

- Edge, latest version
- Firefox, latest version and extended support release
- Chrome, latest version

Review the following considerations and limitations when using Local App Access and URL redirection.

- Local App Access is designed for full-screen, virtual desktops spanning all monitors:
 - The user experience can be confusing if you use Local App Access with a virtual desktop that runs in windowed mode or does not cover all monitors.
 - Multiple monitors —When one monitor is maximized, it becomes the default desktop for all applications started in that session. This default occurs even if the subsequent applications typically start on another monitor.
 - The feature supports one VDA. There is no integration with multiple concurrent VDAs.
- Some applications can behave unexpectedly, affecting users:
 - The drive letters might confuse users, such as local C: rather than virtual desktop C: drive.
 - Available printers in the virtual desktop are not available to local applications.
 - Applications that require elevated permissions cannot be started as client-hosted applications.
 - There is no special handling for single-instance applications (such as Windows Media Player).
 - Local applications appear with the Windows theme of the local machine.
 - Full-screen applications are not supported. These applications include applications that open to a full screen, such as PowerPoint slide shows or photo viewers that cover the entire desktop.
 - Local App Access copies the properties of the local application (such as the shortcuts on the client's desktop and Start menu) on the VDA. However, it does not copy other properties such as shortcut keys and read-only attributes.
 - Applications that customize how overlapping window order is handled can have unpredictable results. For example, some windows might be hidden.

- Shortcuts are not supported, including My Computer, Recycle Bin, Control Panel, Network Drive shortcuts, and folder shortcuts.
 - The following file types and files are not supported: custom file types, files with no associated programs, zip files, and hidden files.
 - Taskbar grouping is not supported for mixed 32-bit and 64-bit client-hosted or VDA applications. That is, grouping 32-bit local applications with 64-bit VDA applications.
 - Applications cannot be started using COM. For example, if you click an embedded Office document from within an Office application, the process start cannot be detected, and the local application integration fails.
- Double-hop scenarios, where a user is starting a virtual desktop from within another virtual desktop session, are not supported.
 - URL redirection supports only explicit URLs (that is, URLs appearing in the browser's address bar or found using the in-browser navigation, depending on the browser).
 - URL redirection works only with desktop sessions, not with application sessions.
 - The local desktop folder in a VDA session does not allow users to create files.
 - Multiple instances of a locally running application behave according to the taskbar settings established for the virtual desktop. However, shortcuts to locally running applications are not grouped with running instances of those applications. They are also not grouped with running instances of hosted applications or pinned shortcuts to hosted applications. Users can close only windows of locally running applications from the Taskbar. Although users can pin local application windows to the desktop Taskbar and Start menu, the applications might not start consistently when using these shortcuts.
 - If you set the **Allow Local App Access** policy setting to **Enabled**, browser content redirection isn't supported. By default, Local App Access is prohibited.

Interaction with Windows

The Local App Access interaction with Windows includes the following behaviors.

- Windows 8 and Windows Server 2012 shortcut behavior
 - Windows Store applications installed on the client are not enumerated as part of Local App Access shortcuts.
 - Image and video files are opened by default using Windows store applications. However, Local App Access enumerates the Windows store applications and opens shortcuts with desktop applications.
- Local Programs
 - For Windows 7, the folder is available in the Start menu.

- For Windows 8, Local Programs is available only when the user chooses **All Apps** as a category from the Start screen. Not all subfolders are displayed in Local Programs.
- Windows 8 graphics features for applications
 - Desktop applications are restricted to the desktop area and are covered by the Start screen and Windows 8 style applications.
 - Local App Access applications do not behave like desktop applications in multi-monitor mode. In multi-monitor mode, the Start screen and the desktop display on different monitors.
- Windows 8 and Local App Access URL Redirection
 - Because Windows 8 Internet Explorer has no add-ons enabled, use desktop Internet Explorer to enable URL redirection.
 - In Windows Server 2012, Internet Explorer disables add-ons by default. To implement URL Redirection, disable the Internet Explorer enhanced configuration. Then reset the Internet Explorer options and restart to ensure that add-ons are enabled for standard users.

Configure Local App Access and URL redirection

To use Local App Access and URL redirection with Citrix Workspace app:

- Install the Citrix Workspace app on the local client machine. You can enable both features during the Citrix Workspace app installation or you can enable Local App Access template using the Group Policy editor.
- Set the **Allow Local App Access** policy setting to **Enabled**. You can also configure URL allow list and block list policy settings for URL redirection. For more information, see [Local App Access policy settings](#).

Enable Local App Access and URL redirection

To enable Local App Access for all local applications, follow these steps:

1. Sign in to Web Studio and click **Policies** in the left pane.
2. In the action bar, click **Create Policy**.
3. In the Create Policy window, type “Allow Local App Access” in the search box and then click **Select**.
4. In the Edit Setting window, select **Allowed**. By default, the **Allow local app access** policy is prohibited. When this setting is allowed, the VDA allows the end-user to decide whether published applications and Local App Access shortcuts are enabled in the session. (When this setting is prohibited, both published applications and Local App Access shortcuts do not work for the VDA.) This policy setting applies to the entire machine and the URL redirection policy.

5. In the Create Policy window, type “URL redirection allow list” in the search box and then click **Select**. The URL redirection allow list specifies URLs to open in the default browser of the remote session.
6. In the Edit Setting window, click **Add** to add the URLs and then click **OK**.
7. In the Create Policy window, type “URL redirection block list” in the search box and then click **Select**. The URL redirection block list specifies URLs that are redirected to the default browser running on the endpoint.
8. In the Edit Setting window, click **Add** to add the URLs and then click **OK**.
9. On the Settings page, click **Next**.
10. On the Users and Machines page, assign the policy to the applicable Delivery Groups and then click **Next**.
11. On the Summary page, review the settings and then click **Finish**.

To enable URL redirection for all local applications during Citrix Workspace app installation, follow these steps:

1. Enable URL redirection when you install the Citrix Workspace app for all users on a machine. Doing so also registers the browser add-ons required for URL redirection.
2. From the command prompt, run the appropriate command to install the Citrix Workspace app using one of the following options:
 - For CitrixReceiver.exe, use `/ALLOW_CLIENTHOSTEDAPPSURL=1`.
 - For CitrixReceiverWeb.exe, use `/ALLOW_CLIENTHOSTEDAPPSURL=1`.

Enable the Local App Access template using the Group Policy editor

Note:

- Before you enable the Local App Access template using the Group Policy editor, add the receiver.admx/adml template files to the local GPO.
- Citrix Workspace app for Windows template files are available in the local GPO in **Administrative Templates > Citrix Components > Citrix Workspace** folder only when you add the CitrixBase.admx/CitrixBase.adml to the %systemroot%\policyDefinitions folder.

To enable the Local App Access template using the Group Policy editor, follow these steps:

1. Run **gpedit.msc**.
2. Go to **Computer Configuration > Administrative Templates > Classic Administrative Templates (ADM) > Citrix Components > Citrix Workspace > User Experience**.
3. Click **Local App Access settings**.
4. Select **Enabled** and then select **Allow URL Redirection**. For URL redirection, register browser add-ons using the command line described in the *Register browser add-ons* section further down in this article.

Provide access only to published applications

You can provide access to published applications using the Registry Editor or the PowerShell SDK.

To the Registry Editor, see [The Local App Access for published applications](#) in the list of features managed through the registry.

To use the PowerShell SDK:

1. Open PowerShell on the machine where the Delivery Controller is running.
2. Enter the following command: `set-configsitemetadata -name "studio_clientHostedApps" -value "true".`

To have access to **Add Local App Access Application** in a Cloud service deployment, use the Citrix DaaS Remote PowerShell SDK. For more information, see [Citrix DaaS Remote PowerShell SDK](#).

1. Download the installer:

<https://download.apps.cloud.com/CitrixPoshSdk.exe>

2. Run these commands:

- a) `asnp citrix.*`
- b) `Get-XdAuthentication`

3. Enter the following command: `set-configsitemetadata -name "studio_clientHostedApps" -value "true".`

After you complete the applicable preceding steps, follow these steps to continue.

1. Sign in to Web Studio and select **Applications** in the left pane.
2. In the upper middle pane, right-click the blank area and select **Add Local App Access Application** from the context menu. You can also click **Add Local App Access Application** in the action bar. To display the Add Local App Access Application option in the action bar, click **Refresh**.
3. Publish Local App Access application.
 - The Local Application Access wizard launches with an Introduction page, which you can remove from future launches of the wizard.
 - The wizard guides you through the Groups, Location, Identification, Delivery, and Summary pages described below. When you are finished with each page, click **Next** until you reach the Summary page.
 - On the Groups page, select one or more Delivery Groups where the new applications will be added, and then click **Next**.

- On the Location page, type the full executable path of the application on the user's local machine, and type the path to the folder where the application is located. Citrix recommends that you use the system environment variable path; for example, %Program-Files(x86)%\Internet Explorer\iexplore.exe.
- On the Identification page, accept the default values or type the information that you want and then click **Next**.
- On the Delivery page, configure how this application is delivered to users and then click **Next**. You can specify the icon for the selected application. You can also specify whether the shortcut to the local application on the virtual desktop is visible on the Start menu, the desktop, or both.
- On the Summary page, review the settings and then click **Finish** to exit the Local Application Access wizard.

Register browser add-ons

Note:

The browser add-ons required for URL redirection are registered automatically when you install the Citrix Workspace app from the command line using the /ALLOW_CLIENTHOSTEDAPPSURL=1 option.

You can use the following commands to register and unregister one or all add-ons:

- To register add-ons on a client device: `<client-installation-folder>\redirector.exe /reg<browser>`
- To unregister add-ons on a client device: `<client-installation-folder>\redirector.exe /unreg<browser>`
- To register add-ons on a VDA: `<VDAinstallation-folder>\VDARedirector.exe /reg<browser>`
- To unregister add-ons on a VDA: `<VDAinstallation-folder>\VDARedirector.exe /unreg<browser>`

Where `<browser>` is Internet Explorer, Firefox, Chrome, or All.

For example, the following command registers Internet Explorer add-ons on a device running the Citrix Workspace app.

```
C:\Program Files\Citrix\ICA Client\redirector.exe/regIE
```

The following command registers all add-ons on a Windows Multi-session OS VDA.

```
C:\Program Files (x86)\Citrix\HDX\bin\VDARedirector.exe /regAll
```

URL interception across browsers

- By default, Internet Explorer redirects the specified URL. If the URL is not in the block list but the browser or website redirects it to another URL, the final URL is not redirected. It is not redirected

even if it is on the block list.

For URL redirection to work correctly, enable the add-on when prompted by the browser. If the add-ons that are using Internet options or the add-ons in the prompt are disabled, URL redirection does not work correctly.

- The Firefox add-ons always redirect the URLs.

When an add-on is installed, Firefox prompts to allow or prevent installing the add-on on a new tab page. Allow the add-on for the feature to work.

- The Chrome add-on always redirects the final URL that is navigated, and not the entered URLs.

The extensions have been installed externally. When you disable the extension, the URL redirection feature does not work in Chrome. If the URL redirection is required in Incognito mode, allow the extension to run in that mode in the browser settings.

Configure local application behavior on logoff and disconnect

Note:

If you do not follow these steps to configure the settings, by default, local applications continue to run when a user logs off or disconnects from the virtual desktop. After reconnection, local applications are reintegrated if they are available on the virtual desktop.

To configure local application behavior on logoff and disconnect, see [Local application behavior on logoff and disconnect](#) in the list of features managed through the registry.

Generic USB redirection and client drive considerations

August 3, 2023

HDX technology provides **optimized support** for most popular USB devices. Optimized support offers an improved user experience with better performance and bandwidth efficiency over a WAN. Optimized support is usually the best option, especially in high latency or security-sensitive environments.

HDX technology provides **generic USB redirection** for specialty devices that don't have optimized support or where it is unsuitable, for example:

- The USB device has more advanced features that are not part of optimized support, such as a mouse or webcam having more buttons.

- Users need functions which are not part of optimized support.
- The USB device is a specialized device, such as test and measurement equipment or an industrial controller.
- An application requires direct access to the device as a USB device.
- The USB device only has a Windows driver available. For example, a smart card reader might not have a driver available for the Citrix Workspace app for Android.
- The version of the Citrix Workspace app does not provide any optimized support for this type of USB device.

With generic USB redirection:

- Users do not need to install device drivers on the user device.
- USB client drivers are installed on the VDA machine.

Important:

- Generic USB redirection can be used together with optimized support. If you enable generic USB redirection, configure Citrix [USB devices policy settings](#) for both generic USB redirection and optimized support.
- The Citrix policy setting in [Client USB device optimization rules](#) is a specific setting for generic USB redirection, for a particular USB device. It doesn't apply to optimized support as described here.

Performance considerations for USB devices

Network latency and bandwidth can affect user experience and USB device operation when using generic USB redirection for some types of USB devices. For example, timing-sensitive devices might not operate correctly over high-latency low-bandwidth links. Use optimized support instead where possible.

Some USB devices require high bandwidth to be usable, for example a 3D mouse (used with 3D apps that also typically require high bandwidth). If bandwidth cannot be increased, you might be able to mitigate the issue by tuning bandwidth usage of other components using the bandwidth policy settings. For more information, see [Bandwidth policy settings](#) for Client USB device redirection, and [Multi-stream connection policy settings](#).

Security considerations for USB devices

Some USB devices are security-sensitive by nature, for example, smart card readers, fingerprint readers, and signature pads. Other USB devices such as USB storage devices can be used to transmit data that might be sensitive.

USB devices are often used to distribute malware. Configuration of Citrix Workspace app and Citrix Virtual Apps and Desktops can reduce, but not eliminate, risk from these USB devices. This situation applies whether generic USB redirection or optimized support is used.

Important:

For security-sensitive devices and data, always secure the HDX connection using either [TLS](#) or IPsec.

Only enable support for the USB devices that you need. Configure both generic USB redirection and optimized support to meet this need.

Provide guidance to users for safe use of USB devices:

- Use only USB devices that have been obtained from a trustworthy source.
- Don't leave USB devices unattended in open environments - for example, a flash drive in an internet cafe.
- Explain the risks of using a USB device on more than one computer.

Compatibility with generic USB redirection

Generic USB redirection is supported for USB 2.0 and earlier devices. Generic USB redirection is also supported for USB 3.0 devices connected to a USB 2.0 or USB 3.0 port. Generic USB redirection does not support USB features introduced in USB 3.0, such as super speed.

These Citrix Workspace apps support generic USB redirection:

- Citrix Workspace app for Windows, see [Configuring application delivery](#).
- Citrix Workspace app for Mac, see [Citrix Workspace app for Mac](#).
- Citrix Workspace app for Linux, see [Optimize](#).
- Citrix Workspace app for Chrome OS, see [Citrix Workspace app for Chrome](#).

For Citrix Workspace app versions, see the [Citrix Workspace app feature matrix](#).

If you are using earlier versions of the Citrix Workspace app, see the Citrix Workspace app documentation to confirm that generic USB redirection is supported. See Citrix Workspace app documentation for any restrictions on USB device types that are supported.

Generic USB redirection is supported for desktop sessions from VDA for Single-session OS version 7.6 through current.

Generic USB redirection is supported for desktop sessions from VDA for Multi-session OS version 7.6 through current, with these restrictions:

- The VDA must be running Windows Server 2012 R2, Windows Server 2016, Windows Server 2019, or Windows Server 2022.

- The USB device drivers must be fully compatible with the Remote Desktop Session Host (RDSH) for the VDA OS (Windows 2012 R2), including full virtualization support.

Some types of USB devices are not supported for generic USB redirection because it would not be useful to redirect them:

- USB modems.
- USB network adapters.
- USB hubs. The USB devices connected to USB hubs are handled individually.
- USB virtual COM ports. Use COM port redirection rather than generic USB Redirection.

For information on USB devices that have been tested with generic USB redirection, see [Citrix Ready Marketplace](#). Some USB devices do not operate correctly with generic USB redirection.

Configure generic USB redirection

You can control, and separately configure, which types of USB devices use generic USB redirection:

- On the VDA, using Citrix policy settings. For more information, see [Redirection of client drives and user devices](#) and [USB devices policy settings](#) in the Policy settings reference
- In Citrix Workspace app, using Citrix Workspace app-dependent mechanisms. For example, an Administrative Template controls registry settings that configure Citrix Workspace app for Windows. By default, USB redirection is allowed for certain classes of USB devices and denied for others. For more information, see [Configure](#) in the Citrix Workspace app for Windows documentation.

This separate configuration provides flexibility. For example:

- If two different organizations or departments are responsible for the Citrix Workspace app and VDA, they can enforce control separately. This configuration applies when a user in one organization accesses an application in another organization.
- Citrix policy settings can control USB devices that are allowed only for certain users or for users connecting only over a LAN (rather than by using Citrix Gateway).

Enable generic USB redirection

To enable generic USB Redirection, and not require manual redirection by the user, configure both Citrix policy settings and Citrix Workspace app connections preferences.

In Citrix policy settings:

1. Add the [Client USB device redirection](#) to a policy and set its value to **Allowed**.

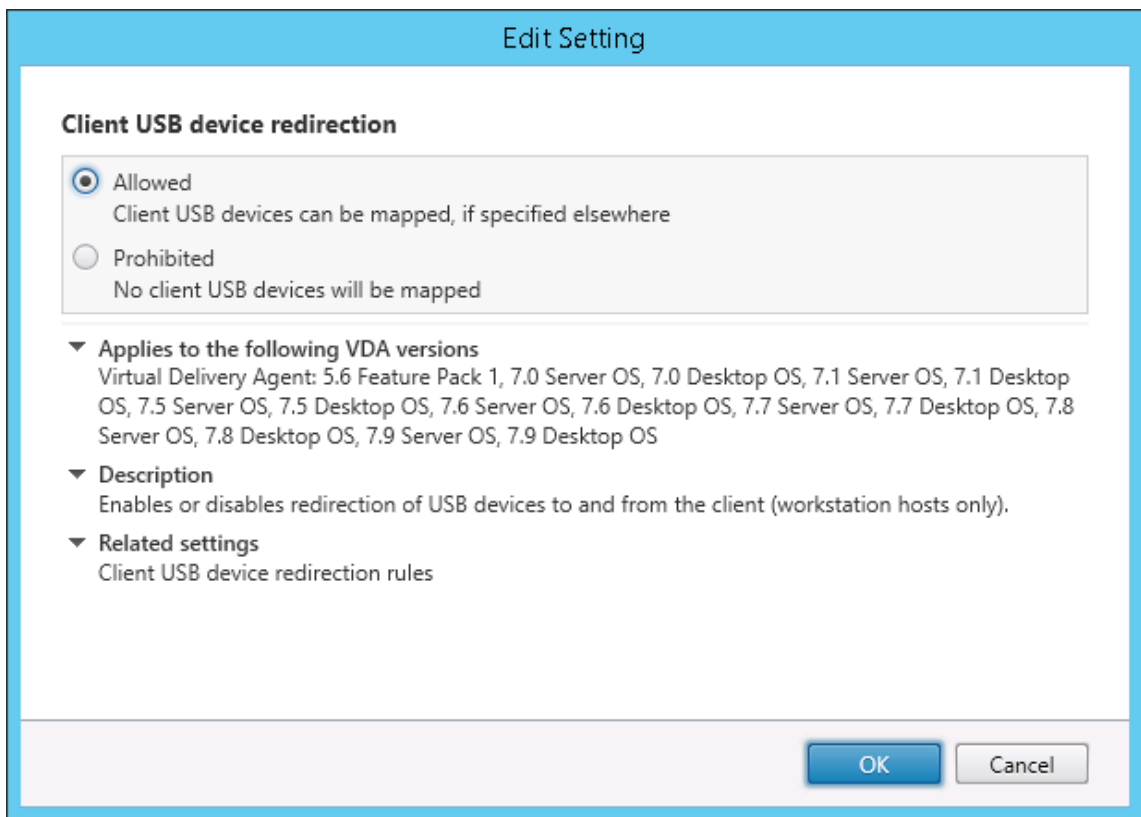

2. (Optional) To update the list of USB devices available for redirection, add the [Client USB device redirection rules](#) setting to a policy and specify the USB policy rules.

Once the policy settings are complete, in Citrix Workspace app:

3. Specify that devices are connected automatically without manual redirection. You can do this using an Administrative template or in the Citrix Workspace app for **Windows > Preferences > Connections**.

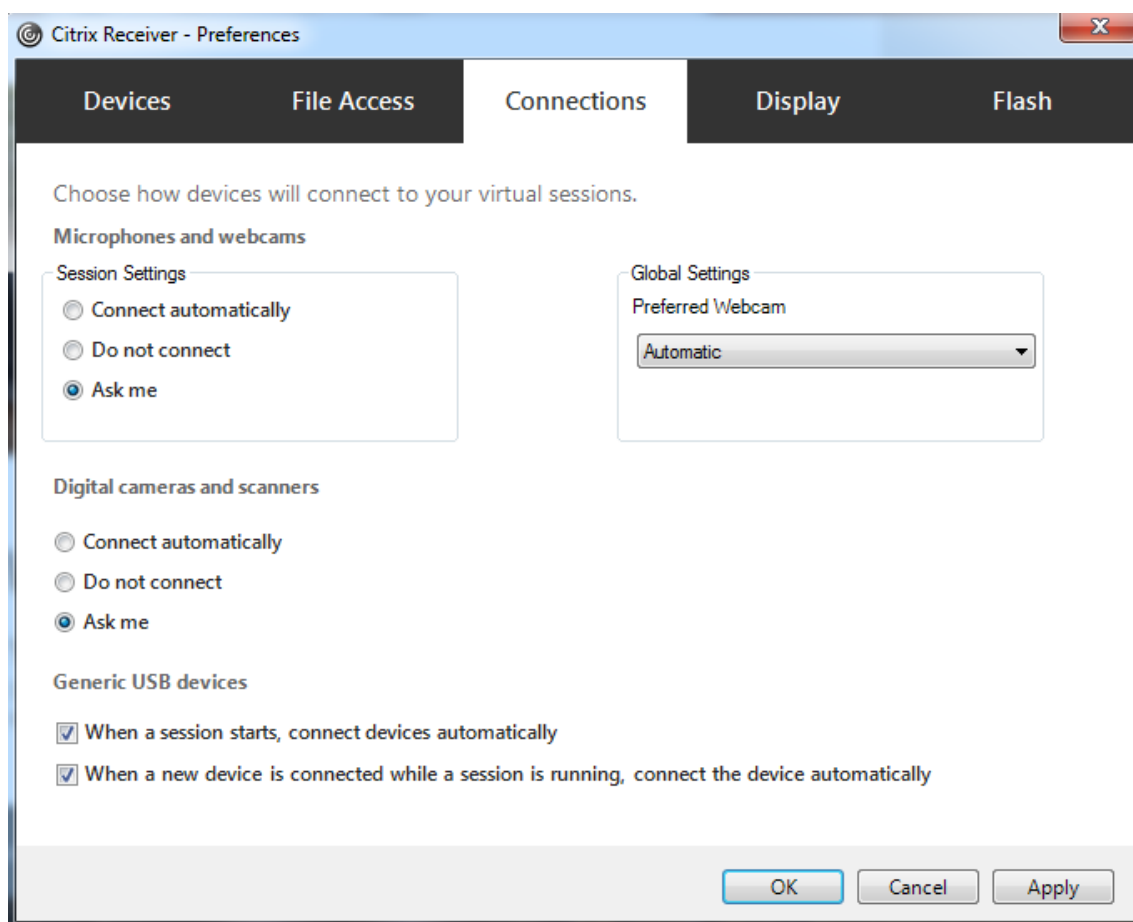

If you specified the USB policy rules for the VDA in the previous step, specify those same policy rules for the Citrix Workspace app.

For thin clients, consult the manufacturer for details of USB support and any required configuration.

Configuring the types of USB devices available for generic USB redirection

USB devices are automatically redirected when USB support is enabled and the USB user preference settings are set to connect USB devices automatically. USB devices are also automatically redirected when the connection bar is not present.

Users can explicitly redirect devices that are not automatically redirected by selecting the devices from the USB device list. For more information, the Citrix Workspace app for Windows user help article, [Display your devices in the Desktop Viewer](#).

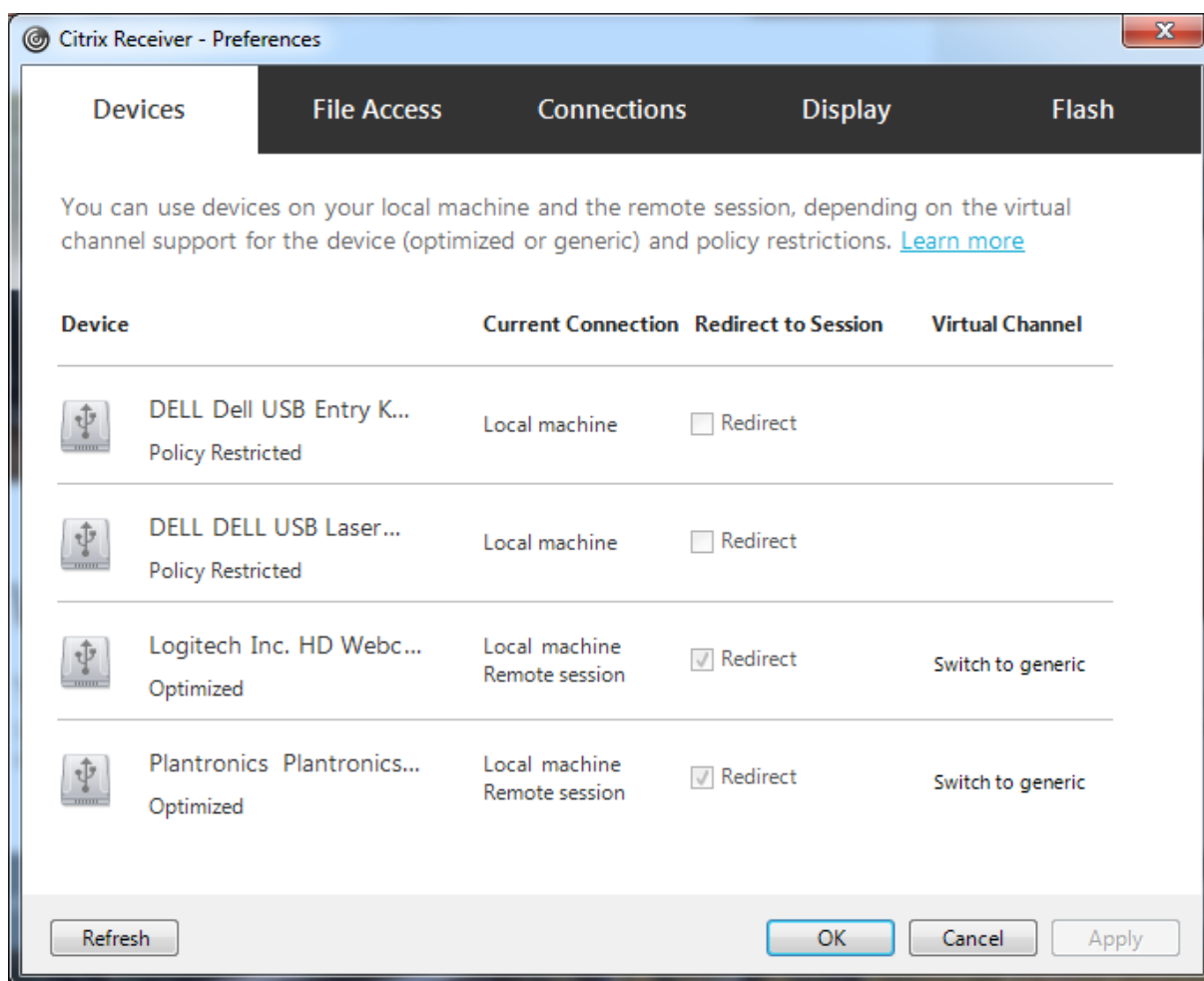

To use generic USB redirection rather than optimized support, you can either:

- In the Citrix Workspace app, manually select the USB device to use generic USB redirection, choose **Switch to generic** from the Devices tab of the Preferences dialog box.
- Automatically select the USB device to use generic USB redirection, by configuring auto-redirection for the USB device type (for example, `AutoRedirectStorage=1`) and set USB user preference settings to automatically connect USB devices. For more information, see [Configure automatic redirection of USB devices](#).

Note:

Only configure generic USB redirection for use with a webcam if the webcam is found to be incompatible with HDX multimedia redirection.

To prevent USB devices from ever being listed or redirected, you can specify device rules for the Citrix Workspace app and the VDA.

For generic USB redirection, you need to know at least the USB device class and subclass. Not all USB devices use their obvious USB device class and subclass. For example:

- Pens use the mouse device class.
- Smart card readers can use the vendor-defined or HID device class.

For more precise control, you need to know the Vendor ID, Product ID, and Release ID. You can get this information from the device vendor.

Important:

Malicious USB devices might present USB device characteristics that do not match their intended usage. Device rules are not intended to prevent this behavior.

You control the USB devices available for generic USB redirection by specifying USB device redirection rules, to override the default USB policy rules.

Citrix DaaS (formerly Citrix Virtual Apps and Desktops service):

- In most cases, [download](#) the Citrix Group Policy Management Console MSI ([CitrixGroupPolicyManagement.msi](#)) and install it in your Active Directory system, and then manage AD group policies. (Do not install the MSI on a VDA.)
- For Citrix Workspace app for Windows, edit the user device registry. An Administrative template (ADM file) is included on the installation media so you can change the user device through the Active Directory Group Policy: `dvd root \os\lang\Support\Configuration\icaclient_usb.adm`

On-premises Citrix Virtual Apps and Desktops:

- For the VDA, edit the administrator override rules for the Multi-session OS machines through group policy rules. The Group Policy Management Console is included on the installation media:
 - x64: `dvd root \os\lang\x64\Citrix Policy\CitrixGroupPolicyManagement_x64.msi`
 - x86: `dvd root \os\lang\x86\Citrix Policy\CitrixGroupPolicyManagement_x86.msi`
- For Citrix Workspace app for Windows, edit the user device registry. An Administrative template (ADM file) is included on the installation media so you can change the user device through the Active Directory Group Policy: `dvd root \os\lang\Support\Configuration\icaclient_usb.adm`

Warning:

Editing the registry incorrectly can cause serious problems that might require you to reinstall your operating system. Citrix cannot guarantee that problems resulting from the incorrect use

of Registry Editor can be solved. Use Registry Editor at your own risk. Be sure to back up the registry before you edit it.

The product default rules are stored in HKEY_LOCAL_MACHINE\SOFTWARE\WOW6432Node\Citrix\ICA Client\GenericUSB. Do not edit these product default rules. Instead, use them as a guide for creating administrator override rules, which is explained later in this article. The GPO overrides are evaluated before the product default rules.

The administrator override rules are stored in HKEY_LOCAL_MACHINE\SOFTWARE\Policies\Citrix\PortICA\Generic. GPO policy rules take the format **{Allow: | Deny:}** followed by a set of *tag=value* expressions separated by white space.

The following tags are supported:

| Tag | Description |
|----------|--|
| VID | Vendor ID from the device descriptor |
| PID | Product ID from the device descriptor |
| REL | Release ID from the device descriptor |
| Class | Class from either the device descriptor or an interface descriptor; see the USB website at http://www.usb.org/ for available USB Class Codes |
| SubClass | Subclass from either the device descriptor or an interface descriptor |
| Prot | Protocol from either the device descriptor or an interface descriptor |

When creating policy rules, note the following:

- Rules are case-insensitive.
- Rules can have an optional comment at the end, introduced by #. A delimiter is not required, and the comment is ignored for matching purposes.
- Blank and pure comment lines are ignored.
- White space is used as a separator, but cannot appear in the middle of a number or identifier. For example, Deny: Class = 08 SubClass=05 is a valid rule, but Deny: Class=0 Sub Class=05 is not.
- Tags must use the matching operator =. For example, VID=1230.
- Each rule must start on a new line or form part of a semicolon-separated list.

Note:

- Starting from Citrix Virtual Apps and Desktops version 2212, some of the USB devices are disabled from using the Generic USB Redirection feature. You must add these devices explicitly using their respective Vendor ID (VID) and Product ID (PID).
- If you are using the ADM template file, you must create rules on a single line, as a semicolon-separated list.

Examples:

- The following example shows an administrator-defined USB policy rule for vendor and product identifiers:

```
Allow: VID=046D PID=C626 # Allow Logitech SpaceNavigator 3D Mouse
Deny: VID=046D # Deny all Logitech products
```

- The following example shows an administrator-defined USB policy rule for a defined class, subclass, and protocol:

```
Deny: Class=EF SubClass=01 Prot=01 # Deny MS Active Sync devices
Allow: Class=EF SubClass=01 # Allow Sync devices
Allow: Class=EF # Allow all USB-Miscellaneous devices
```

Use and remove USB devices

Users can connect a USB device before or after starting a virtual session.

When using Citrix Workspace app for Windows, the following apply:

- Devices connected after a session begins appear immediately in the USB menu of the Desktop Viewer.
- If a USB device is not redirecting properly, you can try to resolve the problem by waiting to connect the device until after the virtual session starts.
- To avoid data loss, use the Windows “Safely Remove Hardware” icon before removing the USB device.

Security controls for USB mass storage devices

Optimized support is provided for USB mass storage devices. This support is part of Citrix Virtual Apps and Desktops client drive mapping. Drives on the user device are automatically mapped to drive letters on the virtual desktop when users log on. The drives are displayed as shared folders that have mapped drive letters. To configure client drive mapping, use the **Client removable drives** setting. This setting is in the [File Redirection policy settings](#) section of the ICA policy settings.

With USB mass storage devices you can use either Client drive mapping or generic USB redirection, or both. Control them using Citrix policies. The main differences are:

| Feature | Client drive mapping | Generic USB redirection |
|--|--|--|
| Enabled by default | Yes | No |
| Read-only access configurable | Yes | No |
| Encrypted device access | Yes, if encryption is unlocked before the device is accessed | Yes |
| BitLocker To Go devices | No | No |
| Safe to delete device during a session | No | Yes, provided users follow operating system recommendations for safe removal |

If both generic USB redirection and the client drive mapping policies are enabled and a mass storage device is inserted either before or after a session starts, it is redirected using client drive mapping. When both generic USB redirection and the client drive mapping policies are enabled and a device is configured for automatic redirection and a mass storage device is inserted either before or after a session starts, it is redirected using generic USB redirection. For more information, see Knowledge Center article [CTX123015](#).

Note:

USB redirection is supported over lower bandwidth connections, for example 50 Kbps. However, copying large files doesn't work.

Print

July 6, 2021

Managing printers in your environment is a multistage process:

1. Become familiar with printing concepts, if you are not already.
2. Plan your printing architecture. This includes analyzing your business needs, your existing printing infrastructure, how your users and applications interact with printing today, and which printing management model best applies to your environment.
3. Configure your printing environment by selecting a printer provisioning method and then creating policies to deploy your printing design. Update policies when new employees or servers are added.

4. Test a pilot printing configuration before deploying it to users.
5. Maintain your Citrix printing environment by managing printer drivers and optimizing printing performance.
6. Troubleshoot issues that may arise.

Printing concepts

Before you begin planning your deployment, make sure that you understand these core concepts for printing:

- The types of printer provisioning available
- How print jobs are routed
- The basics of printer driver management

Printing concepts build on Windows printing concepts. To configure and successfully manage printing in your environment, you must understand how Windows network and client printing works and how this translates into printing behavior in this environment.

Print process

In this environment, all printing is initiated (by the user) on machines hosting applications. Print jobs are redirected through the network print server or user device to the printing device.

There is no persistent workspace for users of virtual desktops and applications. When a session ends the user's workspace is deleted, thus all settings need to be rebuilt at the beginning of each session. As a result, each time a user starts a new session, the system must rebuild the user's workspace.

When a user prints:

- Determines what printers to provide to the user. This is known as printer provisioning.
- Restores the user's printing preferences.
- Determines which printer is the default for the session.

You can customize how to perform these tasks by configuring options for printer provisioning, print job routing, printer property retention, and driver management. Be sure to evaluate how the various option settings might change the performance of printing in your environment and the user experience.

Printer provisioning

The process that makes printers available in a session is known as provisioning. Printer provisioning is typically handled dynamically. That is, the printers that appear in a session are not predetermined

and stored. Instead, the printers are assembled, based on policies, as the session is built during log on and reconnection. As a result, the printers can change according to policy, user location, and network changes, provided they are reflected in policies. Thus, users who roam to a different location might see changes to their workspace.

The system also monitors client-side printers and dynamically adjusts in-session auto-created printers based on additions, deletions, and changes to the client-side printers. This dynamic printer discovery benefits mobile users as they connect from various devices.

The most common methods of printer provisioning are:

- **Universal Print Server** - The Citrix [Universal Print Server](#) provides universal printing support for network printers. The Universal Print Server uses the Universal print driver. This solution enables you to use a single driver on a Multi-session OS machine to allow network printing from any device.

Citrix recommends the Citrix Universal Print Server for remote print server scenarios. The Universal Print Server transfers the print job over the network in an optimized and compressed format, thus minimizing network use and improving the user experience.

The Universal Print Server feature comprises:

A client component, **UPClient** - Enable the UPClient on each Multi-session OS machine that provisions session network printers and uses the Universal print driver.

A server component, **UPServer** - Install UPServer on each print server that provisions session network printers and uses the Universal print driver for the session printers (whether or not the session printers are centrally provisioned).

For Universal Print Server requirements and setup details, refer to the [system requirements](#) and [installation](#) articles.

The following illustration shows the typical workflow for a network based printer in an environment that uses Universal Print Server.

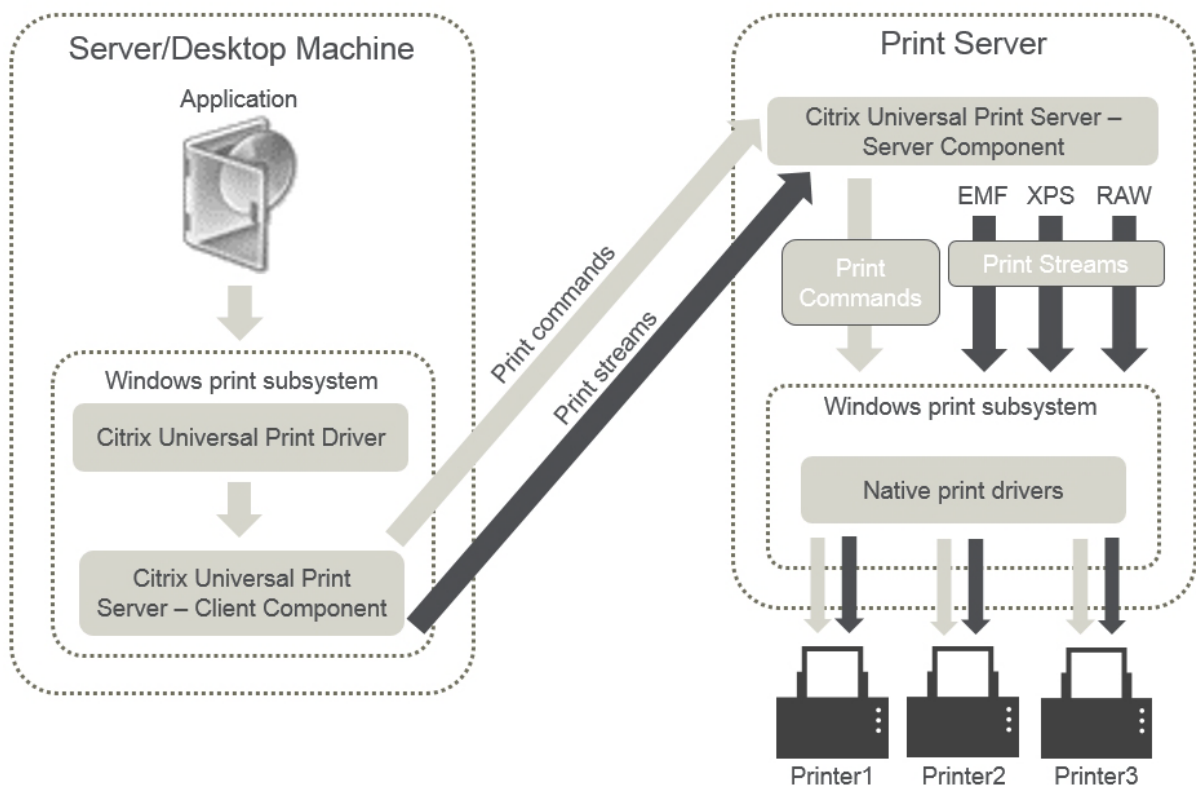

When you enable the Citrix Universal Print Server, all connected network printers leverage it automatically through auto-discovery.

- **Autocreation** - *Autocreation* refers to printers automatically created at the beginning of each session. Both remote network printers and locally attached client printers can be auto-created. Consider auto-creating only the default client printer for environments with a large number of printers per user. Auto-creating a smaller number of printers uses less overhead (memory and CPU) on Multi-session OS machines. Minimizing auto-created printers can also reduce user logon times.

Auto-created printers are based on:

- The printers installed on the user device.
- Any policies that apply to the session.

Autocreation policy settings enable you to limit the number or type of printers that are auto-created. By default, the printers are available in sessions when configuring all printers on the user device automatically, including locally attached and network printers.

After the user ends the session, the printers for that session are deleted.

Client and network printer autocreation has associated maintenance. For example, adding a printer requires that you:

- Update the Session printers policy setting.
- Add the driver to all Multi-session OS machines using the Printer driver mapping and compatibility policy setting.

Print job routing

The term printing pathway encompasses both the path by which print jobs are routed and the location where print jobs are spooled. Both aspects of this concept are important. Routing affects network traffic. Spooling affects utilization of local resources on the device that processes the job.

In this environment, print jobs can take two paths to a printing device: through the client or through a network print server. Those paths are referred to as the client printing pathway and the network printing pathway. Which path is chosen by default depends on the kind of printer used.

Locally attached printers

The system routes jobs to locally attached printers from the Multi-session OS machine, through the client, and then to the print device. The ICA protocol optimizes and compresses the print job traffic. When a printing device is attached locally to the user device, print jobs are routed over the ICA virtual channel.

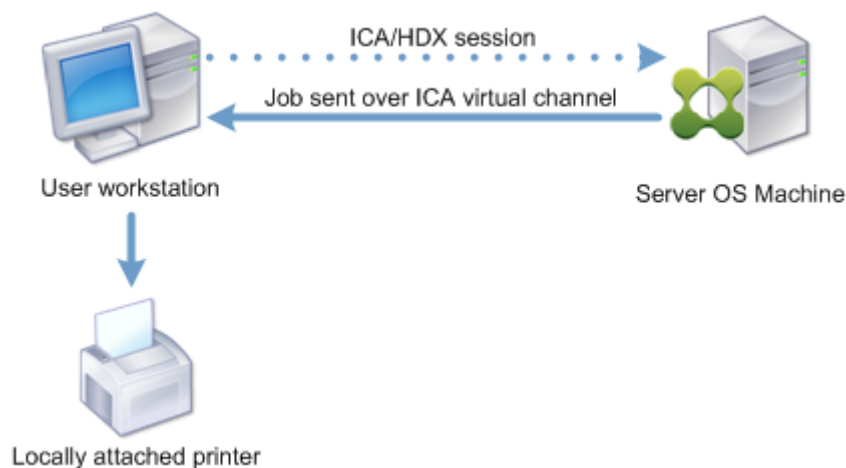

Network-based printers

By default, all print jobs destined for network printers route from the Multi-session OS machine, across the network, and directly to the print server. However, print jobs are automatically routed over the ICA connection in the following situations:

- If the virtual desktop or application cannot contact the print server.

- If the native printer driver is not available on the Multi-session OS machine.

If the Universal Print Server is not enabled, configuring the client printing pathway for network printing is useful for low bandwidth connections, such as wide area networks, that can benefit from the optimization and traffic compression that results from sending jobs over the ICA connection.

The client printing pathway also lets you limit traffic or restrict bandwidth allocated for print jobs. If routing jobs through the user device is not possible, such as for thin clients without printing capabilities, Quality of Service should be configured to prioritize ICA/HDX traffic and ensure a good in-session user experience.

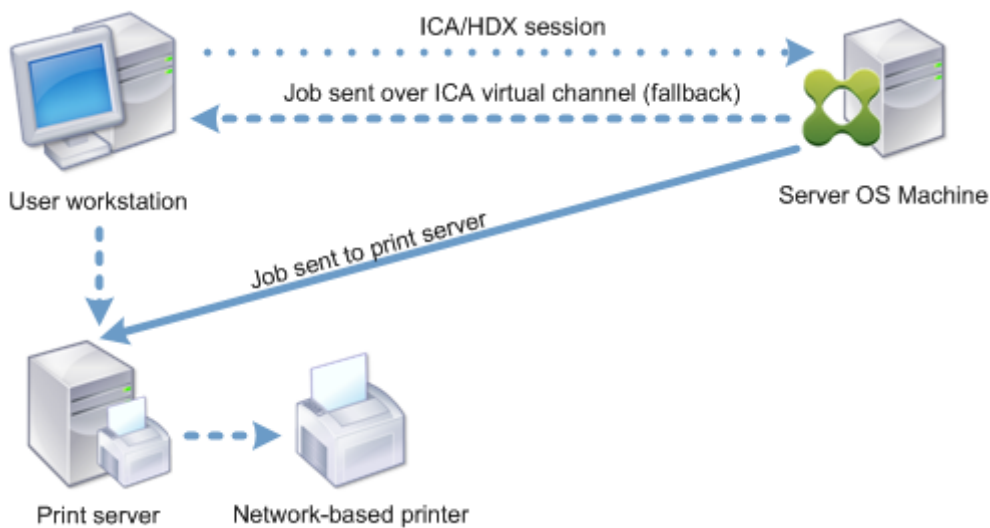

Print driver management

The Citrix Universal Printer Driver (UPD) is a device-independent print driver, which is compatible with most printers. The Citrix UPD consists of two components:

Server component. The Citrix UPD is installed as part of the Citrix Virtual Apps and Desktops VDA installation. The VDA installs the following drivers with Citrix UPD: “Citrix Universal Printer”(EMF driver) and the “Citrix XPS Universal Printer”(XPS driver).

| Name | Processor | Type |
|------------------------------|-----------|--------------------|
| Citrix Universal Printer | x64 | Type 3 - User Mode |
| Citrix XPS Universal Printer | x64 | Type 3 - User Mode |

The VDA installers no longer offer options to control Universal Print Server PDF printer driver installation. The PDF printer driver is now always installed automatically. When you upgrade to the 7.17 VDA (or a later supported version), any previously installed Citrix PDF printer driver is automatically removed and replaced with the latest version.

When a print job is initiated the driver records the output of the application and sends it, without any modification to the end-point device.

Client component. The Citrix UPD is installed as part of the Citrix Workspace app installation. It fetches the incoming print stream for the Citrix Virtual Apps and Desktops session. It then forwards the print stream to the local printing subsystem where the print job is rendered using the device specific printer drivers.

The Citrix UPD supports the following print formats:

- Enhanced Metafile Format (**EMF**), default. EMF is the 32-bit version of the Windows Metafile (WMF) format. The EMF driver can only be used by Windows-based clients.
- XML Paper Specification (**XPS**). The XPS driver uses XML to create a platform-independent “electronic paper” similar to Adobe PDF format.
- Printer Command Language (**PCL5c** and **PCL4**). PCL is a printing protocol developed originally by Hewlett-Packard for inkjet printers. It is used for printing basic text and graphics and is widely supported on HP LaserJet and multifunction peripherals.
- PostScript (**PS**). PostScript is a computer language that can be used for printing text and vector graphics. The driver is widely used in low-cost printers and multifunction peripherals.

The PCL and PS drivers are best suited when using non-Windows based devices such as a Mac or UNIX client. The order in which Citrix UPD attempts to use the drivers can be changed using the [Universal driver preference](#) policy setting.

The Citrix UPD (EMF and XPS drivers) supports advanced printing features such as stapling and paper source selection. These features are available if the native driver makes them available using the Microsoft Print Capability technology. The native driver should use the standardized Print Schema Keywords in the Print Capabilities XML. If non-standard keywords are used, the advanced printing features are not available using Citrix Universal print driver.

The following illustration shows the Universal print driver components and a typical workflow for a printer locally attached to a device.

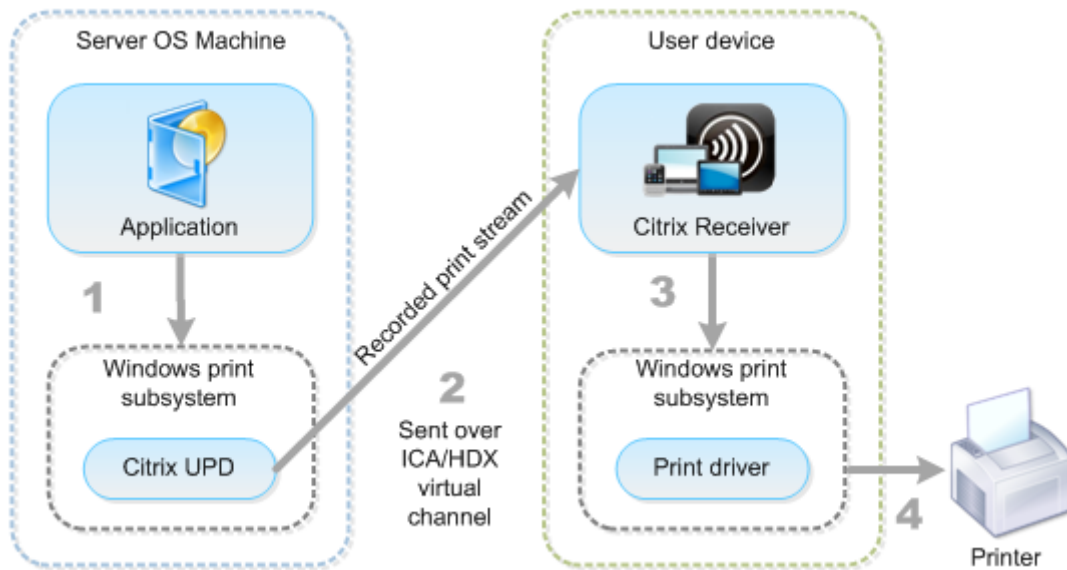

When planning your driver management strategy, determine if you will support the Universal print driver, device-specific drivers, or both. If you support standard drivers, you must determine:

During printer autcreation, if the system detects a new local printer connected to a user device, it checks the Multi-session OS machine for the required printer driver. By default, if a Windows-native driver is not available, the system uses the Universal print driver.

The printer driver on the Multi-session OS machine and the driver on the user device must match for printing to succeed. The illustration that follows shows how a printer driver is used in two places for client printing.

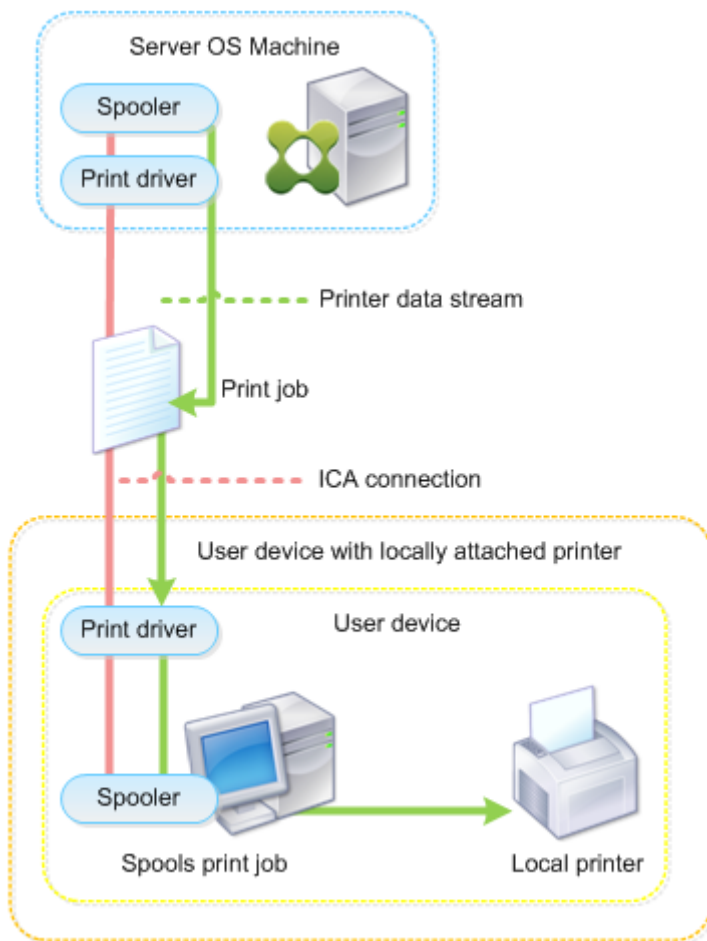

- The types of drivers to support.
- Whether to install printer drivers automatically when they are missing from Multi-session OS machines.
- Whether to create driver compatibility lists.

Related content

- [Printing configuration example](#)
- [Best practices, security considerations, and default operations](#)
- [Print policies and preferences](#)
- [Provision printers](#)
- [Maintain the printing environment](#)

Printing configuration example

October 30, 2020

Choosing the most appropriate printing configuration options for your needs and environment can simplify administration. Although the default print configuration enables users to print in most environments, the defaults might not provide the expected user experience or the optimum network usage and management overhead for your environment.

Your printing configuration depends upon:

- Your business needs and your existing printing infrastructure.
Design your printing configuration around the needs of your organization. Your existing printing implementation (whether users can add printers, which users have access to what printers, and so on) might be a useful guide when defining your printing configuration.
- Whether your organization has security policies that reserve printers for certain users (for example, printers for Human Resources or payroll).
- Whether users need to print while away from their primary work location, such as workers who move between workstations or travel on business.

When designing your printing configuration, try to give users the same experience in a session as they have when printing from local user devices.

Example print deployment

The following illustration shows the print deployment for these use cases:

- **Branch A** - A small overseas branch office with a few Windows workstations. Every user workstation has a locally attached, private printer.
- **Branch B** - A large branch office with thin clients and Windows-based workstations. For increased efficiency, the users of this branch share network-based printers (one per floor). Windows-based print servers located within the branch manage the print queues.
- **Home office** - A home office with a Mac OS-based user device that accesses the company's Citrix infrastructure. The user device has a locally attached printer.

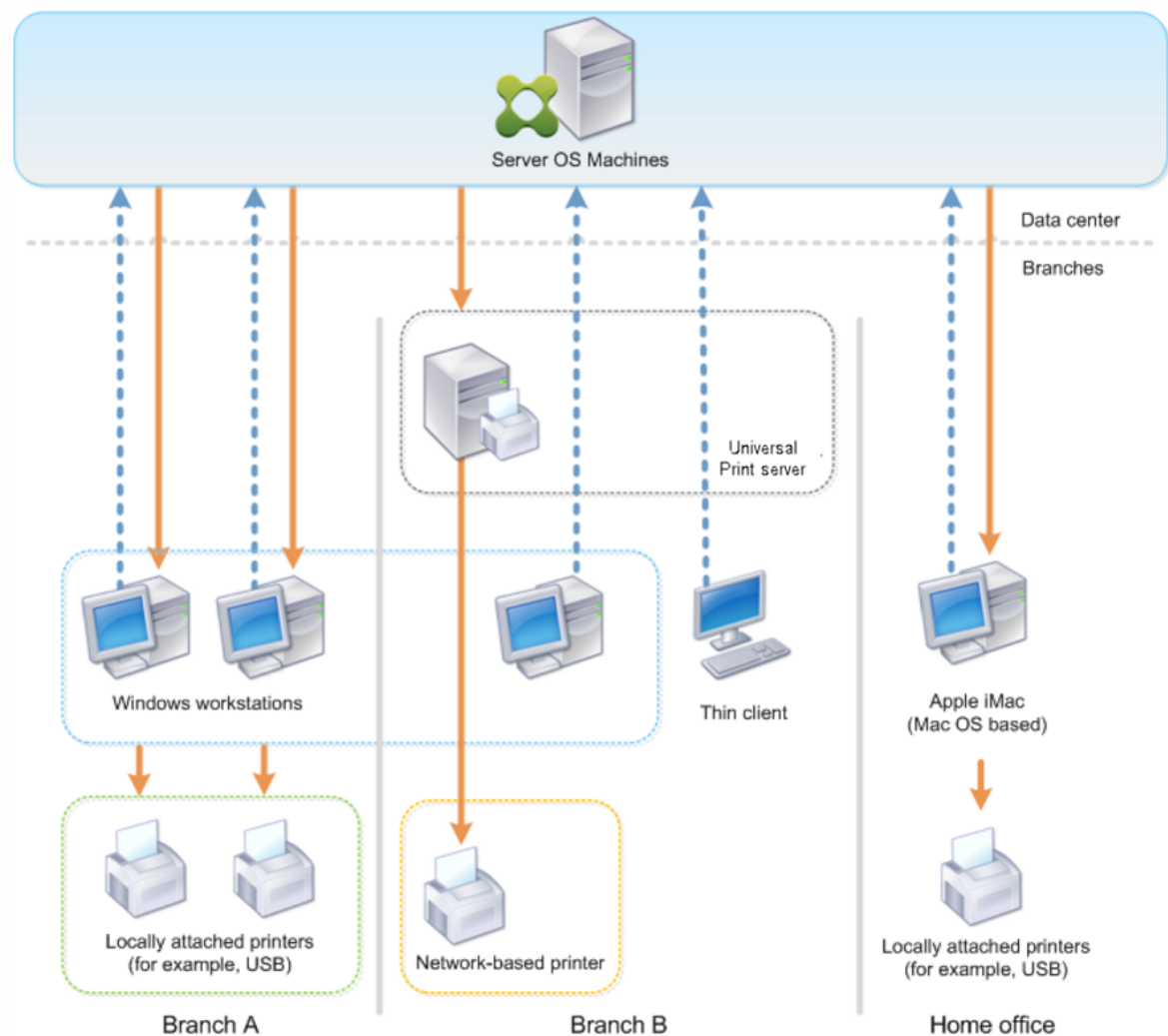

The following sections describe the configurations which minimize the complexity of the environment and simplify its management.

Auto-created client printers and Citrix Universal printer driver

In Branch A, all users work on Windows-based workstations, therefore auto-created client printers and the Universal printer driver are used. Those technologies provide these benefits:

- Performance - Print jobs are delivered over the ICA printing channel, thus the print data can be compressed to save bandwidth.

To ensure that a single user printing a large document cannot degrade the session performance of other users, a Citrix policy is configured to specify the maximum printing bandwidth.

An alternative solution is to leverage a multi-stream ICA connection, in which the print traffic is transferred within a separate low priority TCP connection. Multi-stream ICA is an option when

Quality of Service (QoS) is not implemented on the WAN connection.

- Flexibility - Use of the Citrix Universal printer driver ensures that all printers connected to a client can also be used from a virtual desktop or application session without integrating a new printer driver in the data center.

Citrix Universal Print Server

In Branch B, all printers are network-based and their queues are managed on a Windows print server, thus the Citrix Universal Print Server is the most efficient configuration.

All required printer drivers are installed and managed on the print server by local administrators. Mapping the printers into the virtual desktop or application session works as follows:

- For Windows-based workstations - The local IT team helps users connect the appropriate network-based printer to their Windows workstations. This enables users to print from locally-installed applications.

During a virtual desktop or application session, the printers configured locally are enumerated through autcreation. The virtual desktop or application then connects to the print server as a direct network connection if possible.

The Citrix Universal Print Server components are installed and enabled, thus native printer drivers are not required. If a driver is updated or a printer queue is modified, no additional configuration is required in the data center.

- For thin clients - For thin client users, printers must be connected within the virtual desktop or application session. To provide users with the simplest printing experience, administrators configure a single Citrix Session Printer policy per floor to connect a floor's printer as the default printer.

To ensure the correct printer is connected even if users roam between floors, the policies are filtered based on the subnet or the name of the thin client. That configuration, referred to as proximity printing, allows for local printer driver maintenance (according to the delegated administration model).

If a printer queue needs to be modified or added, Citrix administrators must modify the respective Session printer policy within the environment.

Because the network printing traffic will be sent outside the ICA virtual channel, QoS is implemented. Inbound and outbound network traffic on ports used by ICA/HDX traffic are prioritized over all other network traffic. That configuration ensures that user sessions are not impacted by large print jobs.

Auto-created client printers and Citrix Universal printer driver

For home offices where users work on non-standard workstations and use non-managed print devices, the simplest approach is to use auto-created client printers and the Universal printer driver.

Deployment summary

In summary, the sample deployment is configured as follows:

- No printer drivers are installed on Multi-session OS machines. Only the Citrix Universal printer driver is used. Fallback to native printing and the automatic installation of printer drivers are disabled.
- A policy is configured to auto-create all client printers for all users. Multi-session OS machines will directly connect to the print servers by default. The only configuration required is to enable the Universal Print Server components.
- A session printer policy is configured for every floor of Branch B and applied to all thin clients of the respective floor.
- QoS is implemented for Branch B to ensure excellent user experience.

Best practices, security considerations, and default operations

December 18, 2019

Best practices

Many factors determine the best printing solution for a particular environment. Some of these best practices might not apply to your Site.

- Use the Citrix Universal Print Server.
- Use the Universal printer driver or Windows-native drivers.
- Minimize the number of printer drivers installed on Multi-session OS machines.
- Use driver mapping to native drivers.
- Never install untested printer drivers on a production site.
- Avoid updating a driver. Always attempt to uninstall a driver, restart the print server, and then install the replacement driver.

- Uninstall unused drivers or use the Printer driver mapping and compatibility policy to prevent printers from being created with the driver.
- Try to avoid using version 2 kernel-mode drivers.
- To determine if a printer model is supported, contact the manufacturer or see the Citrix Ready product guide at www.citrix.com/ready.

In general, all of the Microsoft-supplied printer drivers are tested with Terminal Services and guaranteed to work with Citrix. However, before using a third-party printer driver, consult your printer driver vendor so that the driver is certified for Terminal Services by the Windows Hardware Quality Labs (WHQL) program. Citrix does not certify printer drivers.

Security considerations

Citrix printing solutions are secure by design.

- The Citrix Print Manager Service constantly monitors and responds to session events such as logon and logoff, disconnect, reconnect, and session termination. It handles service requests by impersonating the actual session user.
- Citrix printing assigns each printer a unique namespace in a session.
- Citrix printing sets the default security descriptor for auto-created printers to ensure that client printers auto-created in one session are inaccessible to users running in other sessions. By default, administrative users cannot accidentally print to another session's client printer, even though they can see and manually adjust permissions for any client printer.

Default print operations

By default, if you do not configure any policy rules, printing behavior is as follows:

- The Universal Print Server is disabled.
- All printers configured on the user device are created automatically at the beginning of each session.

This behavior is equivalent to configuring the Citrix policy setting Auto-create client printers with the Auto-create all client printers option.

- The system routes all print jobs queued to printers locally attached to user devices as client print jobs (that is, over the ICA channel and through the user device).
- The system routes all print jobs queued to network printers directly from Multi-session OS machines. If the system cannot route the jobs over the network, it will route them through the user device as a redirected client print job.

This behavior is equivalent to disabling the Citrix policy setting Direct connection to print servers.

- The system attempts to store printing properties, a combination of the user's printing preferences and printing device-specific settings, on the user device. If the client does not support this operation, the system stores printing properties in user profiles on the Multi-session OS machine.

This behavior is equivalent to configuring the Citrix policy setting Printer properties retention with the Held in profile only if not saved on client option.

- In VDAs version 7.16 and later, the Citrix policy setting “Automatic installation of inbox printer drivers” does not have any effect on Windows 8 and later Windows operating systems versions because V3 in-box printer drivers are not included in the operating system.
- In VDAs earlier than 7.16, the system uses the Windows version of the printer driver if it is available on the Multi-session OS machine. If the printer driver is not available, the system attempts to install the driver from the Windows operating system. If the driver is not available in Windows, it uses a Citrix Universal print driver.

This behavior is equivalent to enabling the Citrix policy setting “Automatic installation of in-box printer drivers” and configuring the Universal printing setting with the “Use universal printing only if requested driver is unavailable”.

Enabling “Automatic installation of in-box printer drivers” might result in the installation of a large number of native printer drivers.

Note:

If you are unsure about what the shipping defaults are for printing, display them by creating a new policy and setting all printing policy rules to Enabled. The option that appears is the default.

Always-On logging

An Always-On logging feature is available for the print server and printing subsystem on the VDA.

To collate the logs as a ZIP for emailing, or to automatically upload logs to Citrix Insight Services, use the **Start-TelemetryUpload** PowerShell cmdlet.

Printing policies and preferences

December 18, 2019

When users access printers from published applications, you can configure Citrix policies to specify:

- How printers are provisioned (or added to sessions)
- How print jobs are routed
- How printer drivers are managed

You can have different printing configurations for different user devices, users, or any other objects on which policies are filtered.

Most printing functions are configured through the Citrix [Printing policy settings](#). Printing settings follow standard Citrix policy behavior.

The system can write printer settings to the printer object at the end of a session or to a client printing device, provided the user's network account has sufficient permissions. By default, Citrix Workspace app uses the settings stored in the printer object in the session, before looking in other locations for settings and preferences.

By default, the system stores, or retains, printer properties on the user device (if supported by the device) or in the user profile on the Multi-session OS machine. When a user changes printer properties during a session, those changes are updated in the user profile on the machine. The next time the user logs on or reconnects, the user device inherits those retained settings. That is, printer property changes on the user device do not impact the current session until after the user logs off and then logs on again.

Printing preference locations

In Windows printing environments, changes made to printing preferences can be stored on the local computer or in a document. In this environment, when users modify printing settings, the settings are stored in these locations:

- **On the user device itself** - Windows users can change device settings on the user device by right-clicking the printer in the Control Panel and selecting Printing Preferences. For example, if Landscape is selected as page orientation, landscape is saved as the default page orientation preference for that printer.
- **Inside of a document** - In word-processing and desktop-publishing programs, document settings, such as page orientation, are often stored inside documents. For example, when you queue a document to print, Microsoft Word typically stores the printing preferences you specified, such as page orientation and the printer name, inside the document. These settings appear by default the next time you print that document.
- **From changes a user made during a session** - The system keeps only changes to the printing settings of an auto-created printer if the change was made in the Control Panel in the session; that is, on the Multi-session OS machine.
- **On the Multi-session OS machine** - These are the default settings associated with a particular printer driver on the machine.

The settings preserved in any Windows-based environment vary according to where the user made the changes. This also means that the printing settings that appear in one place, such as in a spreadsheet program, can be different than those in others, such as documents. As result, printing settings applied to a specific printer can change throughout a session.

Hierarchy of user printing preferences

Because printing preferences can be stored in multiple places, the system processes them according to a specific priority. Also, it is important to note that device settings are treated distinctly from, and usually take precedence over, document settings.

By default, the system always applies any printing settings a user modified during a session (that is, the retained settings) before considering any other settings. When the user prints, the system merges and applies the default printer settings stored on the Multi-session OS machine with any retained or client printer settings.

Saving user printing preferences

Citrix recommends that you do not change where the printer properties are stored. The default setting, which saves the printer properties on the user device, is the easiest way to ensure consistent printing properties. If the system is unable to save properties on the user device, it automatically falls back to the user profile on the Multi-session OS machine.

Review the Printer properties retention policy setting if these scenarios apply:

- If you use legacy plug-ins that do not allow users to store printer properties on a user device.
- If you use mandatory profiles on your Windows network and want to retain the user's printer properties.

Provision printers

November 23, 2022

Citrix Universal Print Server

When determining the best print solution for your environment, consider the following:

- The Universal Print Server provides features not available for the Windows Print Provider: Image and font caching, advanced compression, optimization, and QoS support.

- The Universal print driver supports the public device-independent settings defined by Microsoft. If users need access to device settings that are specific to a print driver manufacturer, the Universal Print Server paired with a Windows-native driver might be the best solution. With that configuration, you retain the benefits of the Universal Print Server while providing users access to specialized printer functionality. A trade-off to consider is that Windows-native drivers require maintenance.
- The Citrix Universal Print Server provides universal printing support for network printers. The Universal Print Server uses the Universal print driver, a single driver on the Multi-session OS machine that allows local or network printing from any device, including thin clients and tablets.

To use the Universal Print Server with a Windows-native driver, enable the Universal Print Server. By default, if the Windows-native driver is available, it is used. Otherwise, the Universal print driver is used. To specify changes to that behavior, such as to use only the Windows-native driver or only the Universal print driver, update the Universal print driver usage policy setting.

Install the Universal Print Server

To use the Universal Print Server, install the UpsServer component on your print servers, as described in the installation documents, and configure it. For more information, see [Install core components](#) and [Install using the command line](#).

For environments where you want to deploy the UPClient component separately, for example with **XenApp 6.5**:

1. Download the Citrix Virtual Apps and Desktops Virtual Delivery Agent (VDA) standalone package for Windows Single-session OS or Windows Multi-session OS.
2. Extract the VDA using the command line instructions described in [Install using the command line](#).
3. Install the pre-requisites from the `\Image-Full\Support\VcRedist_2013_RTM`
 - `Vcredist_x64 / vcredist_x86`
 - Run x86 for 32-bit only, and both for 64-bit deployments
4. Install the cdf prerequisite from the `\Image-Full\x64\Virtual Desktop Components` or `\Image-Full\x86\Virtual Desktop Components`.
 - `Cdf_x64 / Cdf_x86`
 - x86 for 32-bit, x64 for 64-bit
5. Find the UPClient component in `\Image-Full\x64\Virtual Desktop Components` or `\Image-Full\x86\Virtual Desktop Components`.
6. Install the UPClient component by extracting and then launching the component's MSI.
7. A restart is required after installing the UPClient component.

Opt out of CEIP for the Universal Print Server

You are automatically enrolled in the Citrix Customer Experience Improvement Program (CEIP) when you install the Universal Print Server. The first upload of data occurs after seven days from the date and time of installation.

To opt out of CEIP, edit the registry key **HKLM\Software\Citrix\Universal Print Server\CEIPEnabled** and set the **DWORD** value to **0**.

To opt back in, set the **DWORD** value to **1**.

Caution: Editing the registry incorrectly can cause serious problems that may require you to reinstall your operating system. Citrix cannot guarantee that problems resulting from the incorrect use of Registry Editor can be solved. Use Registry Editor at your own risk. Be sure to back up the registry before you edit it.

For more information, see [Citrix Insight Services](#).

Configure the Universal Print Server

Use the following Citrix policy settings to configure the Universal Print Server. For more information, refer to the on-screen policy settings help.

- **Universal Print Server enable.** Universal Print Server is disabled by default. When you enable Universal Print Server, you choose whether to use the Windows Print Provider if the Universal Print Server is unavailable. After you enable the Universal Print Server, a user can add and enumerate network printers through the Windows Print Provider and Citrix Provider interfaces.
- **Universal Print Server print data stream (CGP) port.** Specifies the TCP port number used by the Universal Print Server print data stream CGP (Common Gateway Protocol) listener. Defaults to **7229**.
- **Universal Print Server web service (HTTP/SOAP) port.** Specifies the TCP port number used by the Universal Print Server listener for incoming HTTP/SOAP requests. Defaults to **8080**.

To change the default port of HTTP 8080 for Universal Print Server communication to Citrix Virtual Apps and Desktops VDAs, the following registry must also be created and the port number value modified on the Universal Print Server computer(s):

```
HKEY_LOCAL_MACHINE\SOFTWARE\Policies\Citrix\PrintingPolicies  
"UpsHttpPort"=DWORD:<portnumber>
```

This port number must match the HDX Policy, Universal Print Server web service (HTTP/SOAP) port, in Studio.

- **Universal Print Server print stream input bandwidth limit (kbps).** Specifies the upper bound (in kilobits-per-second) for the transfer rate of print data delivered from each print job

to the Universal Print Server using CGP. Defaults to 0 (unlimited).

- **Universal Print Servers for load balancing.** This setting lists the Universal Print Servers to be used to load balance printer connections established at session launch, after evaluating other Citrix printing policy settings. To optimize printer creation time, Citrix recommends that all print servers have the same set of shared printers.

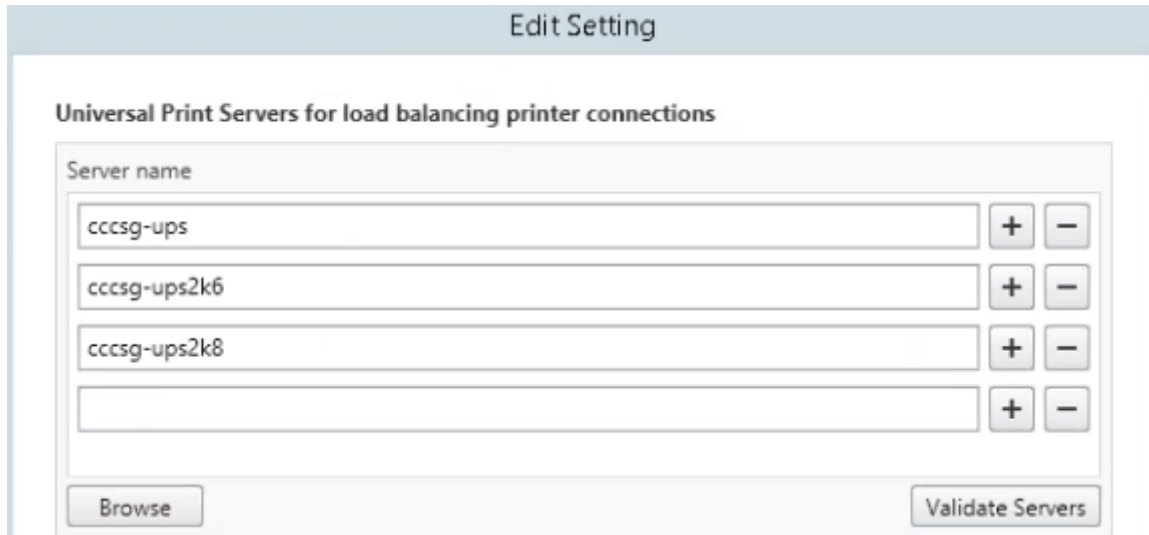

- **Universal Print Servers out-of-service threshold.** Specifies how long the load balancer should wait for an unavailable print server to recover before it determines that the server is permanently offline and redistributes its load to other available print servers. Default is 180 (seconds).

Once the printing policies are modified on the Delivery Controller, it can take a few minutes for the policy changes to be applied to the VDAs.

Interactions with other policy settings - The Universal Print Server honors other Citrix printing policy settings and interacts with them as noted in the following table. The information provided assumes that the Universal Print Server policy setting is enabled, the Universal Print Server components are installed, and the policy settings are applied.

Policy setting

Client printer redirection, Auto-create client printers

Interaction

After the Universal Print Server is enabled, client network printers are created using the Universal print driver instead of the native drivers. Users see the same printer name as before.

| | |
|------------------------------------|--|
| Session printers | When you use the Citrix Universal Print Server solution, Universal print driver policy settings are honored. |
| Direct connections to print server | When the Universal Print Server is enabled and the Universal print driver usage policy setting is configured to use universal printing only, a direct network printer connection can be created to the print server, using the Universal print driver. |
| UPD preference | Supports EMF and XPS drivers. |

Effects on user interfaces - The Citrix Universal print driver used by the Universal Print Server disables the following user interface controls:

- In the Printer Properties dialog box, the Local Printer Settings button
- In the Document Properties dialog box, the Local Printer Settings and Preview on client buttons

The Citrix Universal print driver (EMF and XPS drivers) supports advanced printing features such as stapling and paper source. The user can select Stapling or Paper Source options from the custom UPD print dialog if the client or network printers which are mapped to the UPD in the session support these features.

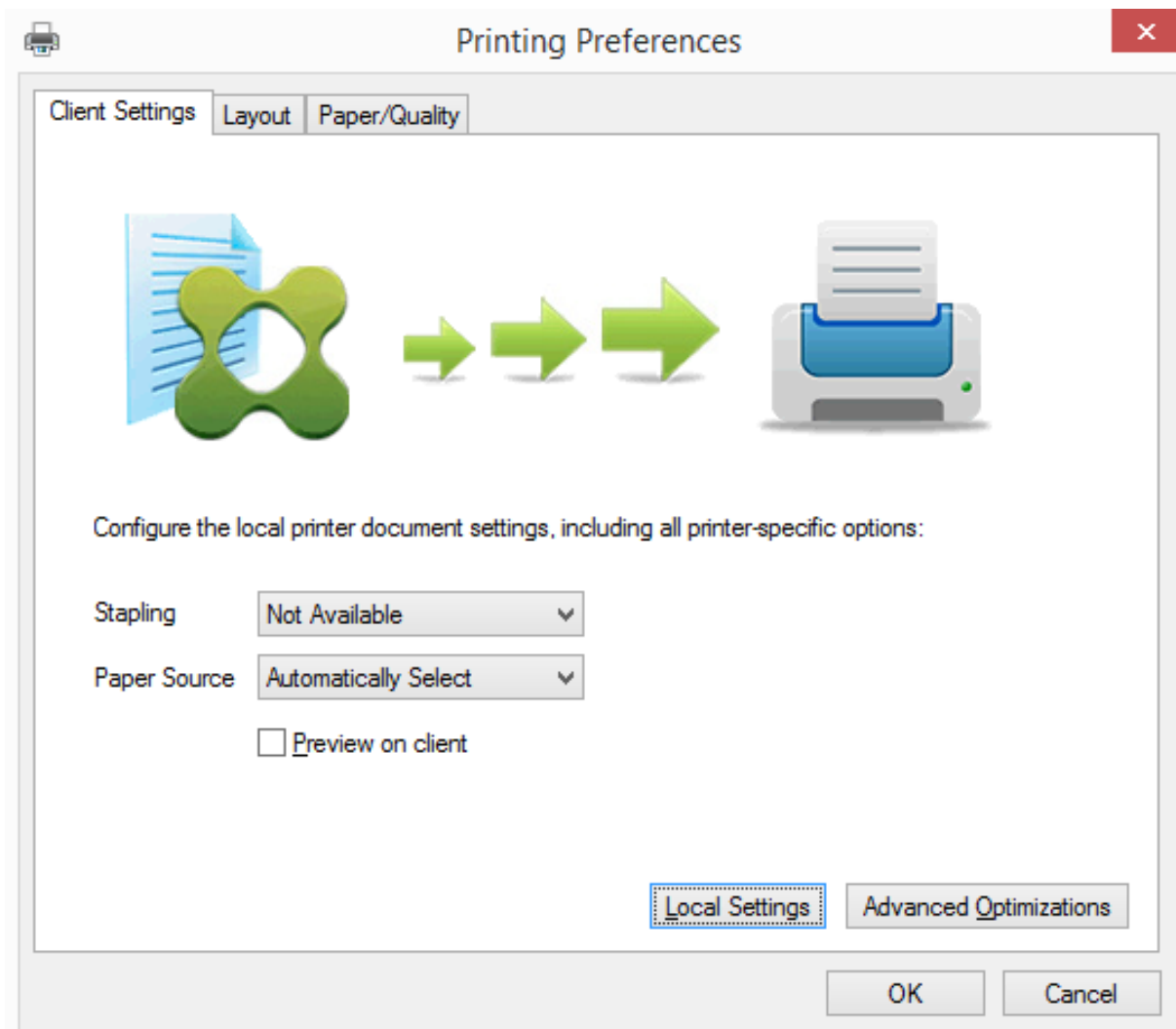

To set non-standard printer settings such as stapling and secure PIN, select **Local Settings** in the customer UPD print dialog for any client mapped printers that use either the Citrix UPD EMF or XPS drivers. The **Printing Preferences** dialog of the mapped printer is displayed outside the session on the client, allowing the user to change any printer option, and the modified printer settings are used in the active session when printing that document.

These features are available if the native driver makes them available using the Microsoft Print Capability technology. The native driver should use the standardized Print Schema Keywords in the Print Capabilities XML. If non-standard keywords are used, the advanced printing features will not be available using Citrix Universal print driver.

When using the Universal Print Server, the Add Printer Wizard for the Citrix Print Provider is the same as the Add Printer Wizard for the Windows Print Provider, with the following exceptions:

- When adding a printer by name or address, you can provide an HTTP/SOAP port number for the print server. That port number becomes a part of the printer name and appears in displays.

- If the Citrix Universal print driver usage policy setting specifies that universal printing must be used, the Universal print driver name appears when selecting a printer. The Windows Print Provider cannot use the Universal print driver.

The Citrix Print Provider does not support client-side rendering.

For more information about the Universal Print Server, see [CTX200328](#).

Auto-created client printers

These universal printing solutions are provided for client printers:

- **Citrix Universal Printer** - A generic printer created at the beginning of sessions that is not tied to a printing device. When you auto-create and use only the Citrix Universal Printer, you might experience reduced resource usage and user sign in times. The Universal Printer can print to any client-side printing device.

The Citrix Universal Printer might not work for all user devices or Citrix Workspace apps in your environment. The Citrix Universal Printer requires a Windows environment and does not support the Citrix Offline Plug-in or applications that are streamed to the client. Consider using auto-created client printers and the Universal print driver for such environments.

To use a universal printing solution for non-Windows Citrix Workspace apps, use one of the other Universal print drivers that are based on Postscript or PCL.

The Citrix Universal Printer lets you select the client's default printer or a specific client printer as the printing destination. To choose a specific printer for a print job, open the **Printing Preferences** dialog box. Select the **Destination Printer** dropdown. The **Default Printer** option sends print jobs to the client's default printer. Any client-redirectioned printers attached to the endpoint running the session are also listed. The printer that you select is saved as the destination printer for any future print jobs.

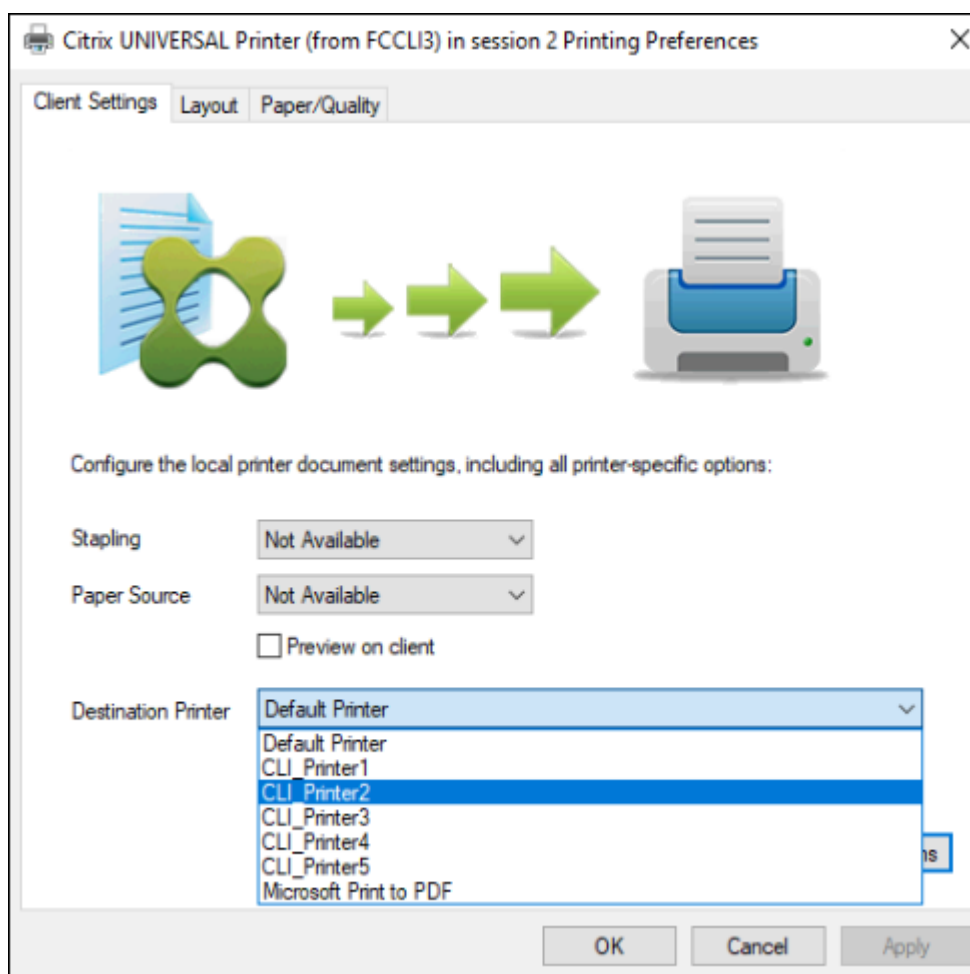

- **Citrix Universal print drivers** - A device-independent printer driver. If you configure a Citrix Universal print driver, the system uses the EMF-based Universal print driver by default.

The Citrix Universal print driver might create smaller print jobs than older or less advanced printer drivers. However, a device-specific driver might be needed to optimize print jobs for a specialized printer.

Configure universal printing - Use the following Citrix policy settings to configure universal printing. For more information, refer to the on-screen policy settings help.

- Universal print driver usage. Specifies when to use universal printing.
- Auto-create generic universal printer. Enables or disables auto-creation of the generic Citrix Universal Printer object for sessions when a user device compatible with Universal Printing is in use. By default, the generic Universal Printer object is not auto-created.
- Universal driver preference. Specifies the order in which the system attempts to use Universal print drivers, beginning with the first entry in the list. You can add, edit, or remove drivers and change the order of the drivers in the list.
- Universal printing preview preference. Specifies whether to use the print preview function for

auto-created or generic universal printers.

- Universal printing EMF processing mode. Controls the method of processing the EMF spool file on the Windows user device. By default, EMF records are spooled directly to the printer. Spooling directly to the printer allows the spooler to process the records faster and uses fewer CPU resources.

For more policies, see [Optimize printing performance](#). To change the defaults for settings such as paper size, print quality, color, duplex, and the number of copies, see [CTX113148](#).

Auto-create printers from the user device - At the start of a session, the system auto-creates all printers on the user device by default. You can control what, if any, types of printers are provisioned to users and prevent autcreation.

Use the Citrix policy setting

Auto-create client printers to control autcreation. You can specify that:

- All printers visible to the user device, including network and locally attached printers, are created automatically at the start of each session (default)
- All local printers physically attached to the user device is created automatically
- Only the default printer for the user device is created automatically
- Autcreation is disabled for all client printers

The Auto-create client printers setting requires that the Client printer redirection setting is Allowed (the default).

Assign network printers to users

By default, network printers on the user device are created automatically at the beginning of sessions. The system enables you to reduce the number of network printers that are enumerated and mapped by specifying the network printers to be created within each session. Such printers are referred to as session printers.

You can filter session printer policies by IP address to provide proximity printing. Proximity printing enables users within a specified IP address range to automatically access the network printing devices that exist within that same range. Proximity printing is provided by the Citrix Universal Print Server and does not require the configuration described in this section.

Proximity printing might involve the following scenario:

- The internal company network operates with a DHCP server which automatically designates IP addresses to users.
- All departments within the company have unique designated IP address ranges.
- Network printers exist within each department's IP address range.

When proximity printing is configured and an employee travels from one department to another, no additional printing device configuration is required. Once the user device is recognized within the new department's IP address range, it will have access to all network printers within that range.

Configure specific printers to be redirected in sessions - To create administrator-assigned printers, configure the Citrix policy setting Session printers. Add a network printer to that policy using one of the following methods:

- Enter the printer UNC path using the format `\\servername\printername`.
- Browse to a printer location on the network.
- Browse for printers on a specific server. Enter the server name using the format `\\servername` and click Browse.

Important: The server merges all enabled session printer settings for all applied policies, starting from the highest to lowest priorities. When a printer is configured in multiple policy objects, custom default settings are taken from only the highest priority policy object in which that printer is configured.

Network printers created with the Session printers setting can vary according to where the session was initiated by filtering on objects such as subnets.

Specify a default network printer for a session - By default, the user's main printer is used as the default printer for the session. Use the Citrix policy setting Default printer to change how the default printer on the user device is established in a session.

1. On the Default printer settings page, select a setting for Choose client's default printer:
 - Network printer name. Printers added with the Session printers policy setting appear in this menu. Select the network printer to use as the default for this policy.
 - Do not adjust the user's default printer. Uses the current Terminal Services or Windows user profile setting for the default printer. For more information, refer to the on-screen policy settings help.
2. Apply the policy to the group of users (or other filtered objects) you want to affect.

Configure proximity printing - Proximity printing is also provided by the Citrix Universal Print Server, which does not require the configuration described here.

1. Create a separate policy for each subnet (or to correspond with printer location).
2. In each policy, add the printers in that subnet's geographic location to the Session printers setting.
3. Set the Default printer setting to Do not adjust the user's default printer.
4. Filter the policies by client IP address. Be sure to update these policies to reflect changes to the DHCP IP address ranges.

Maintain the printing environment

December 18, 2019

Maintaining the printing environment includes:

- Managing printer drivers
- Optimizing printing performance
- Displaying printer and managing print queues

Manage printer drivers

To minimize administrative overhead and the potential for print driver issues, Citrix recommends use of the Citrix Universal print driver.

If auto-creation fails, by default, the system installs a Windows-native printer driver provided with Windows. If a driver is not available, the system falls back to the Universal print driver. For more information about printer driver defaults, refer to [Best practices, security considerations, and default operations](#).

If the Citrix Universal print driver is not an option for all scenarios, map printer drivers to minimize the amount of drivers installed on Multi-session OS machines. In addition, mapping printer drivers enables you to:

- Allow specified printers to use only the Citrix Universal print driver
- Allow or prevent printers to be created with a specified driver
- Substitute good printer drivers for outdated or corrupted drivers
- Substitute a driver that is available on Windows server for a client driver name

Prevent the automatic installation of printer drivers - The automatic installation of print drivers should be disabled to ensure consistency across Multi-session OS machines. This can be achieved through Citrix policies, Microsoft policies, or both. To prevent the automatic installation of Windows-native printer drivers, disable the Citrix policy setting Automatic installation of in-box printer drivers.

Map client printer drivers - Each client provides information about client-side printers during logon, including the printer driver name. During client printer autcreation, Windows server printer driver names are selected that correspond to the printer model names provided by the client. The autcreation process then uses the identified, available printer drivers to construct redirected client print queues.

Here is the general process for defining driver substitution rules and editing print settings for mapped client printer drivers:

1. To specify driver substitution rules for auto-created client printers, configure the Citrix policy setting Printer driver mapping and compatibility by adding the client printer driver name and selecting the server driver that you want to substitute for the client printer driver from the Find printer driver menu. You can use wildcards in this setting. For example, to force all HP printers to use a specific driver, specify HP* in the policy setting.
2. To ban a printer driver, select the driver name and choose the Do not create setting.
3. As needed, edit an existing mapping, remove a mapping, or change the order of driver entries in the list.
4. To edit the printing settings for mapped client printer drivers, select the printer driver, click Settings, and specify settings such as print quality, orientation, and color. If you specify a printing option that the printer driver does not support, that option has no effect. This setting overrides retained printer settings the user set during a previous session.
5. Citrix recommends testing the behavior of the printers in detail after mapping drivers, since some printer functionality can be available only with a specific driver.

When users log on the system checks the client printer driver compatibility list before it sets up the client printers.

Optimize printing performance

To optimize printing performance, use the Universal Print Server and Universal print driver. The following policies control printing optimization and compression:

- Universal printing optimization defaults. Specifies default settings for the Universal Printer when it is created for a session:
 - Desired image quality specifies the default image compression limit applied to universal printing. By default, Standard Quality is enabled, meaning that users can only print images using standard or reduced quality compression.
 - Enable heavyweight compression enables or disables reducing bandwidth beyond the compression level set by Desired image quality, without losing image quality. By default, heavyweight compression is disabled.
 - Image and Font Caching settings specify whether or not to cache images and fonts that appear multiple times in the print stream, ensuring each unique image or font is sent to the printer only once. By default, embedded images and fonts are cached.
 - Allow non-administrators to modify these settings specifies whether or not users can change the default print optimization settings within a session. By default, users are not allowed to change the default print optimization settings.
- Universal printing image compression limit. Defines the maximum quality and the minimum compression level available for images printed with the Universal print driver. By default, the image compression limit is set to Best Quality (lossless compression).

- Universal printing print quality limit. Specifies the maximum dots per inch (dpi) available for generating printed output in the session. By default, no limit is specified.

By default, all print jobs destined for network printers route from the Multi-session OS machine, across the network, and directly to the print server. Consider routing print jobs over the ICA connection if the network has substantial latency or limited bandwidth. To do that, disable the Citrix policy setting Direct connections to print servers. Data sent over the ICA connection is compressed, so less bandwidth is consumed as the data travels across the WAN.

Improve session performance by limiting printing bandwidth - While printing files from Multi-session OS machines to user printers, other virtual channels (such as video) may experience decreased performance due to competition for bandwidth especially if users access servers through slower networks. To prevent such degradation, you can limit the bandwidth used by user printing. By limiting the data transmission rate for printing, you make more bandwidth available in the HDX data stream for transmission of video, keystrokes, and mouse data.

Important:

The printer bandwidth limit is always enforced, even when no other channels are in use.

Use the following Citrix policy bandwidth printer settings to configure printing bandwidth session limits. To set the limits for the site, perform this task using Studio. To set the limits for individual servers, perform this task using the Group Policy Management Console in Windows locally on each Multi-session OS machine.

- The Printer redirection bandwidth limit setting specifies the bandwidth available for printing in kilobits per second (kbps).
- The Printer redirection bandwidth limit percent setting limits the bandwidth available for printing to a percentage of the overall bandwidth available.

Note: To specify bandwidth as a percentage using the Printer redirection bandwidth limit percent setting, enable the Overall session bandwidth limit as well.

If you enter values for both settings, the most restrictive setting (the lower value) is applied.

To obtain real-time information about printing bandwidth, use Citrix Director.

Load balance Universal Print Servers

The Universal Print Server solution can scale by adding more print servers into the load balance solution. There is no single point of failure as each VDA has its own load balancer to distribute the printing load to all print servers.

Use the policy settings, [Universal Print Servers for load balancing](#) and [Universal Print Servers out-of-service threshold](#), to distribute the printing load across all the print servers in the load balance solution.

If there is an unforeseen failure of a print server, the failover mechanism of the load balancer in each VDA automatically redistributes the printer connections allocated on the failed print servers to the other available print servers such that all existing and incoming sessions function normally without affecting the user experience and without requiring the immediate administrator intervention.

Administrators can monitor the activity of the load balanced print servers using a set of performance counters to track the following on the VDA:

- List of load balanced print servers on the VDA and their state (available, unavailable)
- Number of printer connections accepted by each print server
- Number of printer connections failed on each print server
- Number of active printer connection on each print server
- Number of pending printer connections on each print server

Display and manage print queues

The following table summarizes where you can display printers and manage print queues in your environment.

| | | Printing Pathway |
|--|--------------------------|--|
| Client printers (Printers attached to the user device) | Client printing pathway | UAC Enabled On: Print Management snap-in located in the Microsoft Management Console; UAC Enabled Off: Pre-Windows 8: Control Panel, Windows 8: Print Management snap-in |
| Network printers (Printers on a network print server) | Network printing pathway | UAC Enabled On: Print Server > Print Management snap-in located in the Microsoft Management Console; UAC Enabled Off: Print Server > Control Panel |

| | | Printing Pathway |
|---|--------------------------|---|
| Network printers (Printers on a network print server) | Client printing pathway | UAC Enabled On: Print Server > Print Management snap-in located in the Microsoft Management Console; UAC Enabled Off: Pre-Windows 8: Control Panel, Windows 8: Print Management snap-in |
| Local network server printers (Printers from a network print server that are added to a Multi-session OS machine) | Network printing pathway | UAC Enabled On: Print Server > Control Panel; UAC Enabled Off: Print Server > Control Panel |

Note:

Print queues for network printers that use the network printing pathway are private and cannot be managed through the system.

Policies

March 24, 2023

Policies are a collection of settings that define how sessions, bandwidth, and security are managed for a group of users, devices, or connection types.

You can apply policy settings to physical and virtual machines or to users. You can apply settings to individual users at the local level or in security groups in an Active Directory. The configurations define specific criteria and rules. If you don't specifically assign the policies, the settings are applied to all connections.

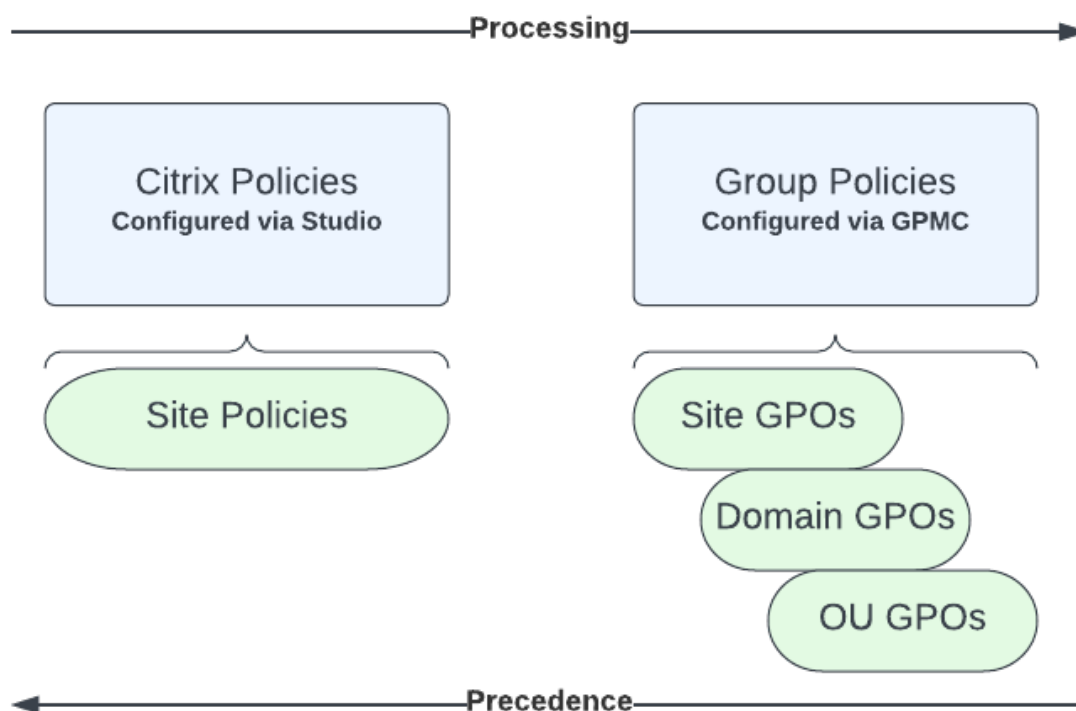

You can apply policies on different levels of the network. Policy settings placed at the Organizational Unit GPO level take the highest precedence on the network. Policies at the Domain GPO level override policies on the Site Group Policy Object level. The Site Group Policy Object level overrides any conflicting policies on both the Microsoft and Citrix Local Policies levels.

All Citrix Local Policies are created and managed in the Web Studio console and stored in the Site Database. Group Policies are created and managed by using the Microsoft Group Policy Management Console (GPMC) and stored in the Active Directory. Microsoft Local Policies are created in the Windows Operating System and are stored in the registry.

Studio uses a Modeling Wizard to help administrators compare configuration settings within templates and policies to help eliminate conflicting and redundant settings. Administrators can set GPOs using the GPMC to configure settings. Also, apply them to a target set of users at different levels of the network.

These GPOs are saved in the Active Directory. Access to the management of these settings is restricted for most of the IT personnel for security.

Settings are merged according to priority and their condition. Any disabled setting overrides a lower-ranked enabled setting. Unconfigured policy settings are ignored and do not override lower-ranked settings.

Local policies can also have conflicts with group policies in the Active Directory, which might override

each other depending on the situation.

All policies are processed in the following order:

1. The end user logs on to a machine using domain credentials.
2. Credentials are sent to the domain controller.
3. Active Directory applies all policies (end user, endpoint, organizational unit, and domain).
4. The end user logs on to Citrix Workspace app and accesses an application or desktop.
5. Citrix and Microsoft policies are processed for the end user and machine hosting the resource.
6. Active Directory determines precedence for policy settings. It then applies them to the registries of the endpoint device and to the machine hosting the resource.
7. The end user logs off from the resource. Citrix policies for the end user and endpoint device are no longer active.
8. The end user logs off the user device, which releases the GPO user policies.
9. The end user turns off the device, which releases the GPO machine policies.

When creating policies for groups of users, devices, and machines, some members might have different requirements and would need exceptions to some policy settings. Exceptions are made by way of filters in the Studio and the GPMC that determine who or what the policy affects.

Note:

We do not support mixing Windows and Citrix policies in the same GPO.

Work with policies

November 9, 2023

Note:

You can manage your Citrix Virtual Apps and Desktops deployment using two management consoles: Web Studio (web-based) and Citrix Studio (Windows-based). This article covers only Web Studio. For information about Citrix Studio, see the equivalent article in Citrix Virtual Apps and Desktops 7 2212 or earlier.

Configure Citrix policies to control user access and session environments. Citrix policies are the most efficient method of controlling connection, security, and bandwidth settings. You can create policies for specific groups of users, devices, or connection types. Each policy can contain multiple settings.

Tools for working with Citrix policies

You can use the following tools with Citrix policies.

- **Web Studio.** If you are a Citrix administrator without permission to manage group policy, use Web Studio to create policies for your site. Policies that are created using Web Studio are stored in the site database, and the updates are pushed to the VDA either when that VDA registers with the broker or when a user connects to that VDA.
- **Local Group Policy Editor** (Microsoft Management Console snap-in). If your network environment uses Active Directory and you have permission to manage group policy, you can use the Local Group Policy Editor to create policies for your site. The settings you configure affect the Group Policy Objects (GPOs) you specify in the Group Policy Management Console.

Important:

We recommend using the Local Group Policy Editor to configure some policy settings. Examples include settings related to registering VDAs with a controller and settings related to Microsoft App-V servers.

Policy processing order and precedence

Group policy settings are processed in the following order:

1. Local GPO
2. Virtual Apps and Desktops site GPO (stored in the Site database)
3. Site-level GPOs
4. Domain-level GPOs
5. Organizational Units

However, if a conflict occurs, policy settings processed last overwrite the settings processed earlier. The order of precedence for policy settings is as follows:

1. Organizational Units
2. Domain-level GPOs
3. Site-level GPOs
4. Virtual Apps and Desktops site GPO (stored in the Site database)
5. Local GPO

For example, a Citrix administrator uses Web Studio to create a policy (Policy A) that enables client file redirection for the company's sales employees. Meanwhile, another administrator uses the Group Policy Editor to create a policy (Policy B) that disables client file redirection for sales employees. When the sales employees log on to the virtual desktops, Policy B is applied and Policy A is ignored. The reason is Policy B was processed at the domain level and Policy A was processed at the Virtual Apps and Desktops site GPO level.

However, when a user launches an ICA or Remote Desktop Protocol (RDP) session, Citrix session settings override the same settings configured in an Active Directory policy or using Remote Desktop

Session Host Configuration. This setting includes settings that are related to typical RDP client connection settings. The examples for the RDP client connection settings are Desktop wallpaper, menu animation, and View window contents while dragging.

When using multiple policies, you can prioritize policies that contain conflicting settings. For more information, see [Compare, prioritize, model, and troubleshoot policies](#).

Workflow for Citrix policies

The process for configuring policies is as follows:

1. Create the policy.
2. Configure policy settings.
3. Assign the policy to machine and user objects.
4. Prioritize the policy.
5. Verify the effective policy by running the Citrix Group Policy Modeling wizard.

Note:

You open the Citrix Group Policy Modeling wizard by navigating to the **Policies > Modeling** tab and then clicking **Launch Modeling Wizard** in the action bar. The **Modeling** tab is available in Web Studio per customer request.

Navigate Citrix policies and settings

In the Local Group Policy Editor, policies and settings appear in two categories: Computer Configuration and User Configuration. Each category has a Citrix Policies node. See the Microsoft documentation for details about navigating and using this snap-in.

In Web Studio, policy settings are sorted into categories based on the functionality or feature they affect. For example, the **Profile Management** section includes policy settings for Profile Management.

- Computer settings (policy settings applying to machines) define the behavior of virtual desktops and are applied when a virtual desktop starts. These settings apply even when there are no active user sessions on the virtual desktop.
- User settings define the user experience when connecting using ICA. User policies are applied when a user connects or reconnects using ICA. User policies aren't applied if a user connects using RDP or logs on directly to the console.

To access policies, settings, or templates, select **Policies** in the Web Studio left pane.

- The **Policies** tab lists all policies. When you select a policy, tabs to the bottom display:
 - * Overview - Lists name, priority, enabled/disabled status, and description
 - * Settings - Lists all configured settings
 - * Assigned To - Lists user and machine objects to which the policy is assigned.For more information, see [Create policies](#).
- The **Templates** tab lists Citrix-provided and custom templates that you created. When you select a template, tabs to the bottom display:
 - * Description (why you might want to use the template)
 - * Settings (list of configured settings). For more information, see [Policy templates](#).
- The **Comparison** tab enables you to compare the settings in a policy or template with those settings in other policies or templates. For example, you might want to verify setting values to ensure compliance with best practices. For more information, see [Compare, prioritize, model, and troubleshoot policies](#).

To search for a setting in a policy or template:

1. Select the policy or template.
2. Select **Edit policy** or **Edit Template** in the action bar.
3. On the **Settings** page, type the name of the setting in the **search** field:

You can refine your search by selecting:

- A specific product version
- A category (for example, Bandwidth)
- Keywords in the setting name
- The **View selected only** check box
- To search only the settings that have been added to the selected policy.

For an unfiltered search, select **All Settings**.

- To search for a setting within a policy:
 1. Select the policy.
 2. Select the **Settings** tab and type the name of the setting.

You can refine your search by selecting a specific product version or by selecting a category. For an unfiltered search, select **All Settings**.

A policy, once created, is independent of the template used. You can use the **Description** field on a new policy to track the source template used.

In the Group Policy Editor, computer and user settings must be applied separately, even if created from a template that includes both types of settings. In this example choosing to use Very High Definition User Experience in Computer Configuration:

- Legacy Graphics mode is a Computer setting that is used in a policy created from this template.
- The User settings, grayed out, is not used in a policy created from this template.

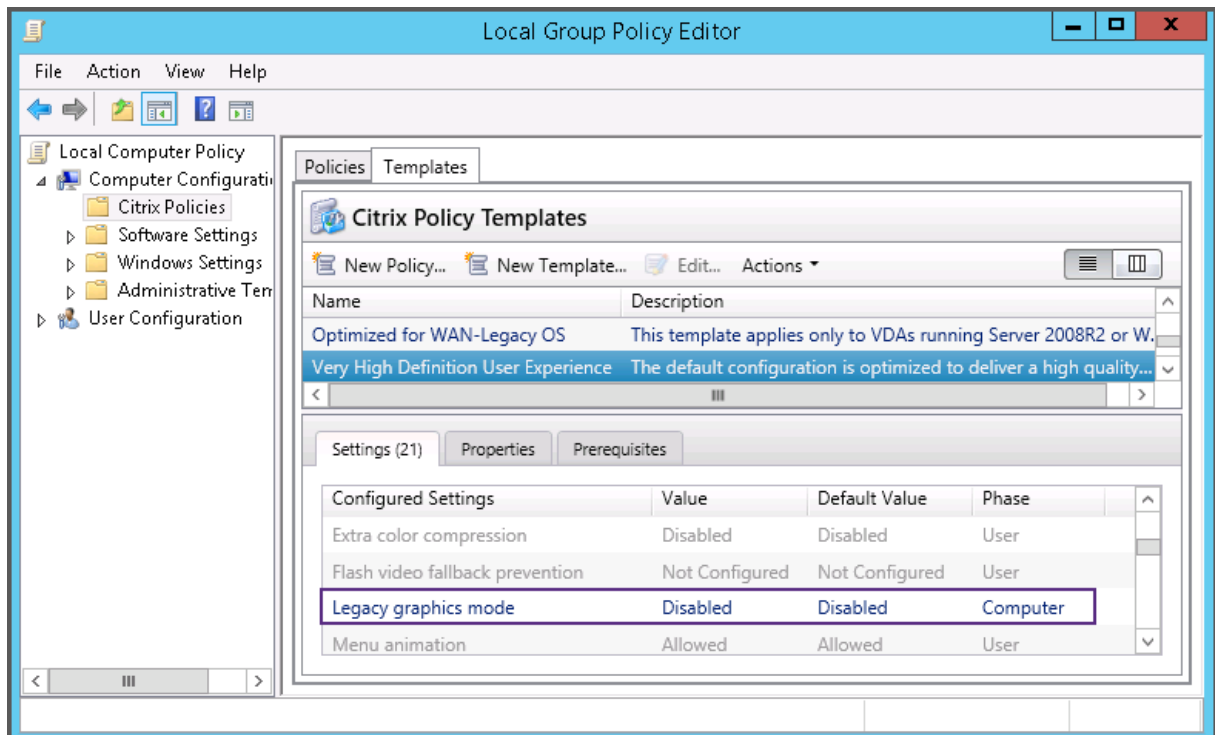

Policy templates

March 16, 2023

Note:

You can manage your Citrix Virtual Apps and Desktops deployment using two management consoles: Web Studio (web-based) and Citrix Studio (Windows-based). This article covers only Web Studio. For information about Citrix Studio, see the equivalent article in Citrix Virtual Apps and Desktops 7 2212 or earlier.

Templates are a source for creating policies from a predefined starting point. Built-in Citrix templates, optimized for specific environments or network conditions, can be used as:

- A source for creating your own policies and templates to share between sites.
- A reference for easier comparison of results between deployments as you are able to quote the results, for example, "...when using Citrix template x or y...".
- A method for communicating policies with Citrix Support or trusted third parties by importing or exporting templates.

Policy templates can be imported and exported.

Built-in Citrix templates

The following policy templates are available:

- **Very High Definition User Experience.** This template enforces default settings that maximize the user experience. Use this template in scenarios where multiple policies are processed in order of precedence.
- **High Server Scalability.** Apply this template to economize on server resources. This template balances user experience and server scalability. It offers a good user experience while increasing the number of users you can host on a single server. This template does not use a video codec for compression of graphics and prevents server side multimedia rendering.
- **High Server Scalability-Legacy OS.** This High Server Scalability template applies only to VDAs running Windows Server 2008 R2 or Windows 7 and earlier. This template relies on the Legacy graphics mode which is more efficient for those operating systems.
- **Optimized for NetScaler SD-WAN.** Apply this template for users working from branch offices with NetScaler SD-WAN for optimizing delivery of Citrix Virtual Desktops. (NetScaler SD-WAN is the new name for CloudBridge).
- **Optimized for WAN.** This template is intended for task workers in branch offices using a shared WAN connection or remote locations with low bandwidth connections accessing applications with graphically simple user interfaces and little multimedia content. This template trades off video playback experience and some server scalability for optimized bandwidth efficiency.
- **Optimized for WAN-Legacy OS.** This *Optimized for WAN* template applies only to VDAs running Windows Server 2008 R2 or Windows 7 and earlier. This template relies on the Legacy graphics mode which is more efficient for those operating systems.
- **Security and Control.** Use this template in environments with low tolerance to risk, to minimize the features enabled by default in Citrix Virtual Apps and Desktops. This template includes settings that disable access to printing, clipboard, peripheral devices, drive mapping, port redirection, and Flash acceleration on user devices. Applying this template might use more bandwidth and reduce user density per server.

While we recommend using the built-in Citrix templates with their default settings, there are settings that do not have a specific recommended value. For example, **Overall session bandwidth limit**, included in the Optimized for WAN templates. In this case, the template exposes the setting so the administrator understands this setting is likely to apply to the scenario.

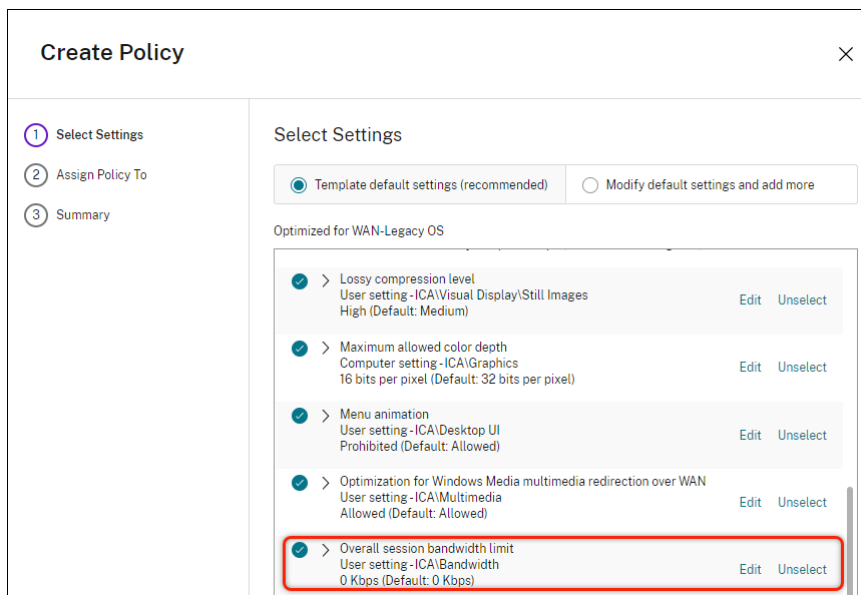

If you are working with a deployment (policy management and VDAs) earlier than XenApp and XenDesktop 7.6 FP3, and require High Server Scalability and Optimized for WAN templates, use the Legacy OS versions of these templates when they apply.

Note:

Citrix creates and updates built-in templates. You cannot modify or delete these templates.

Create and manage templates using Web Studio

To create a template based on a template:

1. Sign in to Web Studio and select **Policies** in the left pane.
2. Select the **Templates** tab and then select the template from which you will create the template.
3. Select **Create Template** in the action bar.
4. Select and configure the policy settings to include in the template. Remove any existing settings that don't belong.
5. Enter a name for the template, and then click **Finish**. The new template appears on the **Templates** tab.

To create a template based on a policy:

1. Sign in to Web Studio and select **Policies** in the left pane.
2. Select the **Policies** tab and then select the policy from which you will create the template.
3. Select **Save as Template** in the action bar.
4. Select and configure any new policy settings to include in the template. Remove any existing settings that don't belong.
5. Enter a name and description for the template, and then click **Finish**.

To import a template:

1. Sign in to Web Studio and select **Policies** in the left pane.
2. Select the **Templates** tab and then select **Import Template**.
3. Select the template file to import and then click **Open**. If you import a template with the same name as an existing template, you can choose to overwrite the existing template or save the template with a different name that is generated automatically.

To export a template:

1. Sign in to Web Studio and select **Policies** in the left pane.
2. Select the **Templates** tab and then select **Export Template**.
3. Select the location where you want to save the template and then click **Save**.

A `.gpt` file is created in the specified location.

Create and manage templates using the Group Policy Editor

From the Group Policy Editor, expand Computer Configuration or User Configuration. Expand the **Policies** node and then select **Citrix Policies**. Choose the appropriate action.

| Task | Instruction |
|---|--|
| Create a template from an existing policy | On the Policies tab, select the policy and then select Actions > Save as Template . |
| Create a policy from an existing template | On the Templates tab, select the template and then click New Policy . |
| Create a template from an existing template | On the Templates tab, select the template and then click New Template . |
| Import a template | On the Templates tab, select Actions > Import . |
| Export a template | On the Templates tab, select Actions > Export . |
| View template settings | On the Templates tab, select the template and then click the Settings tab. |
| View a summary of template properties | On the Templates tab, select the template and then click the Properties tab. |
| View template prerequisites | On the Templates tab, select the template and then click the Prerequisites tab. |

Templates and delegated administration

Policy templates are stored on the machine where the policy management package was installed. This machine is either the Delivery Controller machine or the Group Policy Objects management machine - not the Citrix Virtual Apps and Desktops Site's database. This means that the Windows administrative permissions control the policy template files rather than site's delegated administration roles and scopes.

As a result, an administrator with read-only permission in the Site can, for example, create templates. However, because templates are local files, no changes are made to your environment.

Custom templates are only visible to the user account that creates them and stored in the user's Windows profile. To expose a custom template further, create a policy from it or export it to a shared location.

Create policies

December 5, 2023

Note:

You can manage your Citrix Virtual Apps and Desktops deployment using two management consoles: Web Studio (web-based) and Citrix Studio (Windows-based). This article covers only Web Studio. For information about Citrix Studio, see the equivalent article in Citrix Virtual Apps and Desktops 7 2212 or earlier.

Before creating a policy, decide which group of users or devices it might affect. You might want to create a policy that is based on user job function, connection type, user device, or geographic location. You can also use the same criteria that you use for Windows Active Directory group policies.

If you already created a policy that applies to a group, consider editing that policy instead of creating another policy. After editing the policy, configure the appropriate settings. Avoid creating a policy solely to enable a specific setting or to exclude the policy from applying to certain users.

When you create a policy, you can base it on settings in a policy template and customize settings as needed. You can also create it without using a template and add all the settings you need.

In Web Studio, new policies created are set to Disabled unless the **Enable policy** check box is explicitly checked.

During policy creation and when configuring the settings, the system provides an option to view the settings type. You can view the following settings type:

- All settings - View all applicable to all VDA versions

- Current settings only - View settings specific to the current VDA version
- Legacy settings only - View settings applicable only to the deprecated VDA versions

To view the settings while configuring the settings:

1. Sign in to Web Studio and select **Policies** in the left pane.
 2. In the **Policies** tab, click **Create Policy**.
 3. In the **Select Settings** table, click the drop-down next to **Settings**.
 4. Select one of the following options from the drop-down:
 - All settings-View all settings for all VDA versions
 - Current settings only-View settings for only the current VDA versions
 - Legacy settings only-View settings for only the deprecated VDA versions
1. The **Settings** table lists the settings available based on the previous step.

Policy settings

Policy settings can be enabled, disabled, or not configured. By default, policy settings aren't configured, which means they aren't added to a policy. Settings are applied only when they're added to a policy.

Some policy settings can be in one of the following states:

- Allowed or Prohibited allows or prevents the action controlled by the setting. Sometimes users are allowed or prevented from managing the setting's action in a session. For example, if the menu animation setting is set to Allowed, users can control menu animations in their client environment.
- Enabled or Disabled turns the setting on or off. If you disable a setting, it is not enabled in lower-ranked policies.

In addition, some settings control the effectiveness of dependent settings. For example, Client drive redirection controls whether users are allowed to access the drives on their devices. Both this setting and the **Client network drives** setting must be added to the policy to allow users to access their network drives. If the **Client drive redirection** setting is disabled, users can't access their network drives, even if the **Client network drives** setting is enabled.

In general, policy setting changes that impact machines go into effect either when the virtual desktop restarts or when a user logs on. Policy setting changes that impact users go into effect the next time users log on. If you're using Active Directory, policy settings are updated when Active Directory reevaluates policies at 90-minute intervals. And the policy settings are applied either when the virtual desktop restarts or when a user logs on.

For some policy settings, you can enter or select a value when you add the setting to a policy. You can limit the configuration of the setting by selecting Use default value. This selection disables the

configuration of the setting and allows only the setting's default value to be used when the policy is applied. This selection is regardless of the value that was entered before selecting Use default value.

If the secure default setting is enabled, during VDA installation, the priority of the policy settings is affected as follows:

- Customized setting takes the highest priority
- Secure default setting takes the second priority
- Default setting takes the least priority

To see the secure default setting for a policy:

1. Log in to Web Studio.
2. In the left navigation, click **Policies**.
3. In the **Policies** tab, click **Create Policy**.
4. In the **Select Settings** table, when you hover over the settings that have **Allowed ?** as their current value, the **Secure default value: Prohibited** is shown.

Secure default setting

As best practices:

- Assign policies to groups rather than individual users. If you assign policies to groups, assignments are updated automatically when you add or remove users from the group.
- Do not enable conflicting or overlapping settings in Remote Desktop Session Host Configuration. Sometimes, Remote Desktop Session Host Configuration provides similar functionality to Citrix policy settings. When possible, keep all settings consistent (enabled or disabled) for ease of troubleshooting.
- Disable unused policies. Policies with no settings added create unnecessary processing.

Policy assignments

When creating a policy, you assign it to certain users and machine objects. That policy is applied to connections according to specific criteria or rules. In general, you can add as many assignments as you want to a policy, based on a combination of criteria.

If you do not specify any assignments, or specify assignments but disable them, the policy is applied to **all** connections.

Note:

Policy assignments are also known as policy filters. For additional information, see the following topics:

- [Create, modify, or delete a filter for a policy](#)
- [How do filters get applied?](#)

The following table lists the available assignments:

| Assignment name | Applies a policy based on |
|--------------------------|--|
| Access Control | Access control conditions through which a client is connecting. <i>Connection type</i> - Whether to apply the policy to connections made with or without NetScaler Gateway. <i>NetScaler Gateway farm name</i> - Name of the NetScaler Gateway virtual server. <i>Access condition</i> - Name of the end point analysis policy or session policy to use. |
| NetScaler SD-WAN | Whether a user session is launched through NetScaler SD-WAN. Note: You can add only one NetScaler SD-WAN assignment to a policy. |
| Client IP Address | IP address of the user device used to connect to the session: IPv4 examples: 12.0.0.0, 12.0.0.*, 12.0.0.1-12.0.0.70, 12.0.0.1/24; IPv6 examples: 2001:0db8:3c4d:0015:0:0:abcd:ef12, 2001:0db8:3c4d:0015::/54 |
| Client Name | Name of the user device. Exact match: ClientABCName. Using wildcard: Client*Name. |
| Delivery Group | Delivery Group membership. |
| Delivery Group type | Type of desktop or application: private desktop, shared desktop, private application, or shared application. Note: Private desktop and shared desktop filter options are available only for Citrix Virtual Apps and Desktops 7.x. For more information, see CTX219153 . |
| Organizational Unit (OU) | Organizational unit. |
| Tag | Tags. Note: Apply this policy to all tagged machines. Application tags aren't included. |
| User or Group | User or group name. |

When a user logs on, all policies that match the assignments for the connection are identified. Those policies are sorted into priority order and multiple instances of any setting are compared. Each setting is applied according to the priority ranking of the policy. Any policy setting that is disabled takes

precedence over a lower-ranked setting that is enabled. Policy settings that are not configured are ignored.

Important:

When configuring both Active Directory and Citrix policies using the Group Policy Management Console, assignments and settings might not be applied as expected. For more information, see [CTX127461](#)

A policy named “Unfiltered” is provided by default.

- If you use Web Studio to manage Citrix policies, the settings you add to the Unfiltered policy are applied to all servers, desktops, and connections in a Site.
- If you use the Local Group Policy Editor to manage Citrix policies, the settings you add to the Unfiltered policy are applied to all Sites and connections. The Sites and connections must be within the scope of the Group Policy Objects (GPOs) that includes the policy. For example, the Sales OU includes a GPO called Sales-US that includes all members of the US sales team. The Sales-US GPO is configured with an Unfiltered policy that includes several user policy settings. When the US Sales manager logs on to the Site, the settings in the Unfiltered policy are automatically applied to the session. This configuration is because the user is a member of the Sales-US GPO.

An assignment’s mode determines if the policy is applied only to connections that match all the assignment criteria. If the mode is set to Allow (the default), the policy is applied only to connections that match the assignment criteria. If the mode is set to Deny, the policy is applied if the connection does not match the assignment criteria. The following examples illustrate how assignment modes affect Citrix policies when multiple assignments are present.

- **Example: Assignments of like type with differing modes** - In policies with two assignments of the same type, one set to Allow and one set to Deny, the assignment set to Deny takes precedence, provided the connection satisfies both assignments. For example:

Policy 1 includes the following assignments:

- Assignment A specifies the Sales group. The mode is set to Allow.
- Assignment B specifies the Sales manager’s account. The mode is set to Deny.

Because the mode for Assignment B is set to Deny, the policy isn’t applied when the Sales manager logs on to the Site, even though the user is a member of the Sales group.

- **Example: Assignments of differing type with like modes** - In policies with two or more assignments of differing types, set to Allow, the connection must satisfy at least one assignment of each type for the policy to be applied. For example:

Policy 2 includes the following assignments:

- Assignment C is a User assignment that specifies the Sales group. The mode is set to Allow.
- Assignment D is a Client IP Address assignment that specifies 10.8.169.* (the corporate network). The mode is set to Allow.

When the Sales manager logs on to the Site from the office, the policy is applied because the connection satisfies both assignments.

Policy 3 includes the following assignments:

- Assignment E is a User assignment that specifies the Sales group. The mode is set to Allow.
- Assignment F is an Access Control assignment that specifies NetScaler Gateway connection conditions. The mode is set to Allow.

When the Sales manager logs on to the Site from the office, the policy isn't applied because the connection does not satisfy Assignment F.

Create a policy based on a template, using Web Studio

1. Sign in to Web Studio and select **Policies** in the left pane.
2. Select the **Templates** tab and select a template.
3. Select **Create Policy from Template** in the action bar.
4. By default, the new policy uses all the default settings in the template. In this case, the **Template default settings (recommended)** is selected. If you want to change settings, select the **Modify default settings and add more**, and then add or remove settings.
5. Specify how to apply the policy by selecting one of the following:
 - **Selected user and machine objects.** To apply the policy to selected user and machine objects, and then click **Assign** to select the user and machine objects to which the policy must be applied.
 - **All objects in the site.** To apply the policy to all user and machine objects in the site.
6. Enter a name for the policy. Consider naming the policy according to who or what it affects, for example Accounting Department or Remote Users. Optionally, add a description.

The policy is disabled by default; you can enable it. Enabling the policy allows it to be applied immediately to users logging on. Disabling prevents the policy from being applied. If you must prioritize the policy or add settings later, consider disabling the policy until you are ready to apply it.

Create a policy using Web Studio

1. Sign in to Web Studio and select **Policies** in the left pane.

2. Select the **Policies** tab.
3. Select **Create Policy** in the action bar.
4. Add and configure policy settings.
5. Specify how to apply the policy by choosing one of the following:
 - Assign to selected user and machine objects and then select the user and machine objects to which the policy must be applied.
 - Assign to all objects in a site to apply the policy to all user and machine objects in the Site.
6. Enter a name for the policy or accept the default. Consider naming the policy according to who or what it affects, for example Accounting Department or Remote Users. Optionally, add a description.

The policy is enabled by default; you can disable it. Enabling the policy allows it to be applied immediately to users logging on. Disabling prevents the policy from being applied. If you must prioritize the policy or add settings later, consider disabling the policy until you are ready to apply it.

Create and manage policies using the Group Policy Editor

From the Group Policy Editor, expand **Computer Configuration or User Configuration**. Expand the **Policies** node and then select **Citrix Policies**. Choose the appropriate action:

| Task | Instruction |
|---|---|
| Create a policy | On the Policies tab, click New . |
| Edit an existing policy | On the Policies tab, select the policy and then click Edit . |
| Change the priority of an existing policy | On the Policies tab, select the policy and then click either Higher or Lower . |
| View summary information about a policy | On the Policies tab, select the policy and then click the Summary tab. |
| View and amend policy settings | On the Policies tab, select the policy and then click the Settings tab. |
| View and amend policy filters | On the Policies tab, select the policy and then click the Filters tab. When you add more than one filter to a policy, all the filter conditions must be met for the policy to be applied. |

| Task | Instruction |
|---|--|
| Enable or disable a policy | On the Policies tab, select the policy and then select either Actions > Enable or Actions > Disable . |
| Create a policy from an existing template | On the Templates tab, select the template and then click New Policy . |

Policy sets

October 30, 2023

Policy sets are objects in Citrix DaaS that group policies together for simplified role-based access. Just like a machine catalog is a collection of machines, a policy set is a collection of policies. You can create policy sets to mirror logical divisions in your administrative team and company.

For example, you might have a policy set for each geographic region, business unit, or environment. Policy sets are then assigned scopes and delivery groups so that only authorized administrators can manage the policies that apply to their relevant users and machines.

Important:

To enable policy sets, you must go to **Settings** and turn on **Enable role-based access for policies using policy sets**. To disable the setting, you must remove all policy sets first, with the exception of the **Default Policy Set**.

Create a policy set

You can create new policy sets under the **Policies** section of Citrix Virtual Apps and Desktops.

To create a policy set:

1. In Web Studio, select **Policies** and click **Create Policy Set**.
2. Click **Next** on the **Introduction** page. You can optionally select **Don't show this again** if you want to skip this page in the future.
3. Select the scopes to which this policy set is available and click **Next**.
4. Assign the policy set to one or more delivery groups and click **Next**.
5. On the **Summary** page, review your selections. Enter a **Name** and **Description** for the policy set and click **Finish**.

After the policy set is created, you can click **Create Policy** to add more policies to the selected set. You can also clone, edit, or delete the policy set, or create more policy sets as needed.

Clone a policy set

You can clone an existing policy set by selecting a policy set and clicking **Clone Policy Set**. This action clones the policy set, with its settings and policies, which you can then configure.

To clone a policy set:

1. In **Web Studio > Policies**, select an existing policy set.
2. Click **Clone Policy Set**.
3. Click **Next** on the **Introduction** page.
4. Edit the scopes to which this policy set is available, if needed. Click **Next**.
5. Edit the delivery groups to which this policy set is assigned, if needed. Click **Next**.
6. Edit the policies contained in this policy set, if needed. You can optionally click the name of a policy to change its settings and assignments. Click **Next** to proceed.
7. On the **Summary** page, review your selections. Enter a **Name** and **Description** for the new policy set and click **Clone**.

The process of cloning a policy set might take a few minutes.

Edit a policy set

To edit a policy set:

1. In **Web Studio > Policies**, select an existing policy set.
2. Click **Edit Policy Set**.
3. Change the settings of the policy set as needed.
4. After you have finished, click **Finish**.

Delete a policy set

To delete a policy set, select an existing policy set and click **Delete Policy Set**.

Note:

The **Default Policy Set** is always present and you cannot delete it.

Compare, prioritize, and troubleshoot policies

November 9, 2023

Note:

You can manage your Citrix Virtual Apps and Desktops deployment using two management consoles: Web Studio (web-based) and Citrix Studio (Windows-based). This article covers only Web Studio. For information about Citrix Studio, see the equivalent article in Citrix Virtual Apps and Desktops 7 2212 or earlier.

You can use multiple policies to customize your environment to meet users' needs based on their job functions, geographic locations, or connection types. For example, for enhanced security, place restrictions on user groups who regularly interact with sensitive data.

You can also create a policy that prevents users from saving sensitive files on their local client drives. However, if some users in the user group do need access to their local drives, you can create another policy for only those users. You then rank or prioritize the two policies to control which one takes precedence. When using multiple policies, you must determine:

- How to prioritize the policies
- How to create exceptions
- How to view the effective policy when policies conflict.

In general, policies override similar settings configured for the entire Site, for specific Delivery Controllers, or on the user device. The exception to this principle is security. The highest encryption setting in your environment, always overrides other settings and policies. The highest encryption setting includes the operating system and the most restrictive shadowing settings.

Citrix policies interact with policies that you set in your operating system. In a Citrix environment, Citrix settings override the same settings configured in an Active Directory policy or using Remote Desktop Session Host Configuration. This setting includes settings that are related to typical Remote Desktop Protocol (RDP) client connection settings. The typical RDP settings include settings such as desktop wallpaper, menu animation, and view window contents while dragging.

Some policy settings, such as Secure ICA, must match the settings in the operating system. If a higher priority encryption level is set elsewhere, the **Secure ICA policy** settings that you specify in the policy or when you're delivering application and desktops can be overridden.

For example, the encryption settings that you specify when creating Delivery Groups must be at the same level as the encryption settings you specified throughout your environment.

Note:

In the second hop of double-hop scenarios, consider that a Single-session OS VDA connects to Multi-session OS VDA. In this case, Citrix policies act on the Single-session OS VDA as if it were the user device. For example, consider policies are set to cache images on the user device. In this example, the images cached for the second hop in a double-hop scenario are cached on the Single-session OS VDA machine.

Use the policy modeling wizard

Policy modeling helps you simulate enabled policies with filters for planning and testing purposes. Only enabled policies with filters are modeled. Disabled policies are never applied and enabled policies without filters are always applied.

Perform the following steps to open the **Policy Modeling** wizard:

1. Select **Policies** from the left navigation.
2. Select the **Modeling** tab.
3. Select **Policy Modeling** in the action bar.
4. Read the **Introduction** page and click **Next**.
5. Select users or computers. You can browse for containers or specific users or computers. Click **Next**.
6. Choose your filter evidence. You can optionally get more granular with your simulation by entering additional details, such as **Delivery group**, **Tags**, **Client IP address**, and so on. Click **Next**.
7. Review the summary of your selections and click **Run**.

After you click **Run**, the wizard generates a report of the modeling results. While viewing this report, you can:

- Select if you would like to view **All settings**, **Computer settings**, or **User settings** in the drop-down menu.
- Use the search bar to look for specific settings.
- Click a specific setting to view details of that setting. For example, if all user settings were not applied for a specific policy, the **Details** pane shows you the reason why the settings were not applied.
- Click **Export** to export the modeling results in JSON format, HTML format, or both.

After running policy modeling, more options become available to you. You can:

- **View Modeling Report:** This opens the same modeling report from above so you can view it again or export it.

- **Rerun Policy Modeling:** This allows you to rerun policy modeling with the same set of criteria selected previously and generate new modeling results. This is useful if some policies have changed and you would like to see how those changes affect your current model.
- **Delete Modeling Report:** This deletes the current modeling report.

Compare policies and templates

You can compare the settings in a policy or template with the settings of the other policies or templates. For example, you might need to verify setting values to maintain compliance with best practices. You might also want to compare settings in a policy or template with the default settings that are provided by Citrix.

1. Sign in to Web Studio and select **Policies** in the left pane.
2. Click the **Comparison** tab and then click **Select**.
3. Choose the policies or templates to compare. To include default values in the comparison, select the **Compare to default settings** check box.
4. After you click **Compare**, the configured settings are displayed in columns.
5. To see all settings, select **Show All Settings**. To return to the default view, select **Show Common Settings**.

Prioritize policies

Prioritizing policies allows you to define the precedence of policies when they contain conflicting settings. When a user logs on, all policies that match the assignments for the connection are identified. Those policies are sorted into priority order and multiple instances of any setting are compared. Each setting is applied according to the priority ranking of the policy.

You prioritize policies by giving them different priority numbers. By default, new policies are given the lowest priority. If policy settings conflict, a policy with a higher priority (a priority number of 1 is the highest) overrides a policy with a lower priority. Settings are merged according to priority and the setting's condition. For example, whether the setting is disabled or enabled. Any disabled setting overrides a lower-ranked setting that is enabled. Policy settings that are not configured are ignored and do not override the settings of lower-ranked settings.

1. Select **Policies** in the left pane. Make sure that you select the **Policies** tab.
2. On the **Policies** tab, select **Change Policy Priorities** in the action bar. The **Change Policy Priorities** page appears.
3. In the priority list, use one of the following ways to change the priority for a policy:
 - Drag the policy to a desired position.

- To move it up or down by one position, click the Up or Down arrow icon respectively.
- To move it to the top or bottom of the list, click the Top or Bottom arrow icon respectively.
- To change the priority number, click the **Edit** icon, enter a number as needed, and then click **Save**.

4. Click **Save**.

Exceptions

When you create policies for groups of users, user devices, or machines, you might find that some members of the group require exceptions to some policy settings. You can create exceptions by:

- Creating a policy only for those group members who need the exceptions and then ranking the policy higher than the policy for the entire group
- Using the Deny mode for an assignment added to the policy

An assignment with the mode set to Deny applies a policy only to connections that do not match the assignment criteria. For example, a policy includes the following assignments:

- Assignment A is a client IP address assignment that specifies the range 208.77.88.*. The mode is set to Allow
- Assignment B is a user assignment that specifies a particular user account. The mode is set to Deny.

The policy is applied to all users who log on to the Site with IP addresses in the range that is specified in Assignment A. However, the policy isn't applied to the user logging on to the Site with the user account specified in Assignment B.

Determine which policies apply to a connection

A connection might not respond as expected because multiple policies apply. If a higher priority policy applies to a connection, it can override the settings you configure in the original policy. You can calculate the Resultant Set of Policy and determine how final policy settings are merged for a connection.

You can calculate the Resultant Set of Policy in the following ways:

- Use the **Citrix Group Policy Modeling** Wizard to simulate a connection scenario and discern how Citrix policies might be applied. You can specify conditions for a connection scenario such as:
 - Domain controller
 - Users

- Citrix policy assignment evidence values
- Simulated environment settings such as slow network connection

The report that the wizard produces lists the Citrix policies that take effect in the scenario. Because you log on to the Controller as a domain user, the wizard calculates the results using both site policy settings and Active Directory Group Policy Objects (GPOs).

- Use **Group Policy Results** to produce a report describing the Citrix policies in effect for a given user and controller. The Group Policy Results tool helps you evaluate the current state of GPOs in your environment and generates a report. The generated report describes how these objects, including Citrix policies, are currently being applied to a particular user and controller.

You can launch the Citrix Group Policy Modeling Wizard in Web Studio. Or, you can launch the Group Policy Results tool through the Group Policy Management Console in Windows.

Site policy settings created using Web Studio aren't included in the Resultant Set of Policy in the following cases:

- If you run the Citrix Group Policy Modeling Wizard from the Group Policy Management Console
- If you run the Group Policy Results tool from the Group Policy Management Console

To verify that you obtain the most comprehensive Resultant Set of Policy, Citrix recommends launching the Citrix Group Policy Modeling wizard from Web Studio, unless you create policies using only the Group Policy Management Console.

Troubleshoot policies

Users, IP addresses, and other assigned objects can have multiple policies that apply simultaneously. This scenario can result in conflicts where a policy might not behave as expected. When you run the Citrix Group Policy Modeling Wizard or the Group Policy Results tool, you might discover that no policies are applied to user connections. In such a scenario, policy settings are not applied to the users who connect to their applications and desktops under conditions that match the policy evaluation criteria. This situation occurs when:

- No policies have assignments that match the policy evaluation criteria.
- Policies that match the assignment do not have any settings configured.
- Policies that match the assignment are disabled.

If you want to apply policy settings to the connections that meet the specified criteria, make sure:

- The policies you want to apply to those connections are enabled.
- The policies you want to apply have the appropriate settings configured.

Default policy settings

February 5, 2024

The following tables list policy settings, their default, and the Virtual Delivery Agent (VDA) versions to which they apply.

ICA

| Name | Default setting | VDA |
|--|--|---|
| Adaptive transport | Off. Use when preferred | VDA 7.13–7.15; VDA 7.16 through current |
| Client clipboard redirection | Allowed | All VDA versions |
| Client clipboard write allowed formats | No formats are specified | VDA 7.6 through current |
| Desktop launches | Prohibited | VDA for Multi-session OS 7 through current |
| ICA listener port number | 1494 | All VDA version |
| Launching of non-published programs during client connection | Prohibited | VDA for Multi-session OS 7 through current |
| Limit clipboard client to session transfer size | Disabled | VDA 2009 |
| Limit clipboard session to client transfer size | Disabled | VDA 2009 |
| Loss tolerant mode | Allowed | VDA 2003. Note: Loss tolerance mode isn't yet available. This version of the VDA supports it when it becomes available. |
| Loss tolerant thresholds | When loss tolerant mode is available: Packet loss: 5%, Latency: 300 ms (RTT) | VDA 2003 through current |
| Rendezvous protocol | Disabled | Applies only to HDX sessions established through Citrix Cloud. |
| Restrict client clipboard write | Prohibited | VDA 7.6 through current |
| Restrict session clipboard write | Prohibited | VDA 7.6 through current |

| Name | Default setting | VDA |
|---|--------------------------|--|
| Session clipboard write allowed formats | No formats are specified | VDA 7.6 through current |
| Tablet mode toggle | Enabled | VDA 7.16 through current; for VDA 7.14 and 7.15 LTSR, configure this setting using the registry. |
| Virtual channel allow list | Enabled | VDA 2109 through current |

ICA/Adobe Flash delivery/Flash redirection

| Name | Default setting | VDA |
|---|-----------------|-----------------------------|
| Flash video fallback prevention | Not configured | VDA 7.6 FP3 through current |
| Flash video fallback prevention error *.swf | | VDA 7.6 FP3 through current |

ICA/Audio

| Name | Default setting | VDA |
|------------------------------------|------------------------------|---|
| Adaptive Audio | Enabled | Applies to both single-session OS and multi-session OS sessions of VDAs using Citrix Virtual Apps and Desktops 2109 or later. |
| Audio over UDP real-time transport | Allowed | All VDA versions |
| Audio Plug N Play | Allowed | VDA for Multi-session OS 7 through current |
| Audio quality | High - high definition audio | All VDA versions |
| Client audio redirection | Allowed | All VDA versions |
| Client microphone redirection | Allowed | All VDA versions |
| Loss tolerant mode for audio | Prohibited | VDA versions 2402 and above |

ICA/Auto client reconnect

| Name | Default setting | VDA |
|--------------------------------------|----------------------------------|--------------------------|
| Auto client reconnect | Allowed | All VDA versions |
| Auto client reconnect authentication | Do not require authentication | All VDA versions |
| Auto client reconnect logging | Do not log auto-reconnect events | All VDA versions |
| Auto client reconnect timeout | 120 seconds | VDA 7.13 through current |
| Reconnect UI transparency level | 80% | VDA 7.13 through current |

ICA/Bandwidth

| Name | Default setting | VDA |
|---|-----------------|---|
| Audio redirection bandwidth limit | 0 Kbps | All VDA versions |
| Audio redirection bandwidth limit percent | 0 | All VDA versions |
| Client USB device redirection bandwidth limit | 0 Kbps | VDA 5.5, 5.6 FP1, VDA for Multi-session OS 7 through current, VDA for Single-session OS 7 through current |
| Client USB device redirection bandwidth limit percent | 0 | VDA 5.5, 5.6 FP1, VDA for Multi-session OS 7 through current, VDA for Single-session OS 7 through current |
| Clipboard redirection bandwidth limit | 0 Kbps | All VDA versions |
| Clipboard redirection bandwidth limit percent | 0 | All VDA versions |
| COM port redirection bandwidth limit | 0 Kbps | All VDA versions; for VDA 7.0 through 7.8, configure this setting using the registry |

| Name | Default setting | VDA |
|---|-----------------|---|
| COM port redirection bandwidth limit percent | 0 | All VDA versions; for VDA 7.0 through 7.8, configure this setting using the registry |
| File redirection bandwidth limit | 0 Kbps | All VDA versions |
| File redirection bandwidth limit percent | 0 | All VDA versions |
| HDX MediaStream Multimedia Acceleration bandwidth limit | 0 Kbps | VDA 5.5, 5.6 FP1, VDA for Multi-session OS 7 and VDA for Single-session OS 7 through current VDA for Multi-session OS and VDA for Single-session OS |
| HDX MediaStream Multimedia Acceleration bandwidth limit percent | 0 | VDA 5.5, 5.6 FP1, VDA for Multi-session OS 7 through current, VDA for Single-session OS 7 through current |
| LPT port redirection bandwidth limit | 0 Kbps | All VDA versions; for VDA 7.0 through 7.8, configure this setting using the registry |
| LPT port redirection bandwidth limit percent | 0 | All VDA versions; for VDA 7.0 through 7.8, configure this setting using the registry |
| Overall session bandwidth limit | 0 Kbps | All VDA versions |
| Printer redirection bandwidth limit | 0 Kbps | All VDA versions |
| Printer redirection bandwidth limit percent | 0 | All VDA versions |
| TWAIN device redirection bandwidth limit | 0 Kbps | VDA 5.5, 5.6 FP1, VDA for Multi-session OS 7 through current, VDA for Single-session OS 7 through current |
| TWAIN device redirection bandwidth limit percent | 0 | VDA 5.5, 5.6 FP1, VDA for Multi-session OS 7 through current, VDA for Single-session OS 7 through current |

ICA/Bidirectional content redirection

| Name | Default setting | VDA |
|---|-----------------|--------------------------|
| Allow bidirectional content redirection | Prohibited | VDA 7.13 through current |
| Allowed URLs to be redirected to client | empty | VDA 7.13 through current |
| Allowed URLs to be redirected to VDA | empty | VDA 7.13 through current |
| Bidirectional content redirection configuration | Disabled | VDA 2311 through current |

ICA/Browser content redirection

| Name | Default setting | VDA |
|---|---|--------------------------|
| Browser content redirection | Allowed | VDA 7.16 through current |
| Browser content redirection ACL configuration | https://www.youtube.com/ * | VDA 7.16 through current |
| Browser content redirection Integrated Windows Authentication support | Prohibited | VDA 2106 through current |
| Browser content redirection proxy configuration | empty | VDA 7.16 through current |
| Browser content redirection server fetch web proxy authentication | Prohibited | VDA 2012 through current |

ICA/Client sensors

| Name | Default setting | VDA |
|--|-----------------|--|
| Allow applications to use the physical location of the client device | Prohibited | VDA 5.6 FP1, VDA for Multi-session OS 7 through current, VDA for Single-session OS 7 through current |

ICA/Desktop UI

| Name | Default setting | VDA |
|--|---|---|
| Desktop Composition Redirection | Disabled (7.6 FP3 through current); Enabled (5.6 through 7.6 FP2) | VDA 5.6, VDA for Single-session OS 7 through 7.15 |
| Desktop Composition Redirection graphics quality | Medium | VDA 5.6, VDA for Single-session OS 7 through 7.15 |
| Desktop wallpaper | Allowed | All VDA versions |
| Menu animation | Allowed | All VDA versions |
| View window contents while dragging | Allowed | All VDA versions |

ICA/End user monitoring

| Name | Default setting | VDA |
|--|-----------------|------------------|
| ICA round trip calculation | Enabled | All VDA versions |
| ICA round trip calculation interval | 15 seconds | All VDA versions |
| ICA round trip calculations for idle connections | Disabled | All VDA versions |

ICA/Enhanced desktop experience

| Name | Default setting | VDA |
|-----------------------------|-----------------|--|
| Enhanced Desktop Experience | Allowed | VDA for Multi-session OS 7 through current |

ICA/File redirection

| Name | Default setting | VDA |
|-------------------------------|-----------------|---|
| Auto connect client drives | Allowed | All VDA versions |
| Client drive redirection | Allowed | All VDA versions |
| Client fixed drives | Allowed | All VDA versions |
| Client floppy drives | Allowed | All VDA versions |
| Client network drives | Allowed | All VDA versions |
| Client optical drives | Allowed | All VDA versions |
| Client removable drives | Allowed | All VDA versions |
| Host to client redirection | Disabled | VDA for Multi-session OS 7 through current |
| Preserve client drive letters | Disabled | VDA 5, 5.5, 5.6 FP1, VDA for Single-session OS 7 through current |
| Read-only client drive access | Disabled | VDA 5.5, 5.6 FP1, VDA for Multi-session OS 7 through current, VDA for Single-session OS 7 through current |
| Special folder redirection | Allowed | Web Interface deployments only; VDA for Multi-session OS 7 through current |
| Use asynchronous writes | Disabled | All VDA versions |

ICA/Graphics

| Name | Default setting | VDA |
|-------------------------------------|---------------------------|--|
| Allow visually lossless compression | Disabled | VDA 7.6 through current |
| Display memory limit | 65,536 Kb | VDA 5, 5.5, 5.6 FP1, VDA for Single-session OS 7 through current |
| Display mode degrade preference | Degrade color depth first | All VDA versions |

| Name | Default setting | VDA |
|---|--------------------------------|---|
| Dynamic windows preview | Enabled | VDA 5.5, 5.6 FP1, VDA for Multi-session OS 7 through current, VDA for Single-session OS 7 through current |
| Graphics status indicator | Disabled | VDA 7.16 through current |
| Image caching | Enabled | VDA 5.5, 5.6 FP1, VDA for Multi-session OS 7 through current, VDA for Single-session OS 7 through current |
| Legacy graphics mode | Disabled | VDA for Multi-session OS 7 through current, VDA for Single-session OS 7 through current |
| Maximum allowed color depth | 32 bits per pixel | All VDA versions |
| Notify user when display mode is degraded | Disabled | VDA for Multi-session OS 7 through current |
| Optimize for 3D graphics workload | Disabled | VDA 7.17 through current |
| Queuing and tossing | Enabled | All VDA versions |
| Screen sharing | Disabled | VDA 2112 |
| Use video codec for compression | Use video codec when preferred | VDA 7.6 FP3 through current |
| Use hardware encoding for video codec | Enabled | VDA 7.11 through current |

ICA/Graphics/Caching

| Name | Default setting | VDA |
|----------------------------|-----------------|--|
| Persistent cache threshold | 3,000,000 bps | VDA for Multi-session OS 7 through current |

ICA/Graphics/Framehawk

| Name | Default setting | VDA |
|--------------------------------------|-----------------|-----------------------------|
| Framehawk display channel | Disabled | VDA 7.6 FP2 through current |
| Framehawk display channel port range | 3224,3324 | VDA 7.6 FP2 through current |

ICA/Keep alive

| Name | Default setting | VDA |
|------------------------|-------------------------------------|------------------|
| ICA keep alive timeout | 60 seconds | All VDA versions |
| ICA keep alives | Do not send ICA keep alive messages | All VDA versions |

ICA/Keyboard and IME

| Name | Default setting | VDA |
|---|-----------------|--|
| Client Keyboard Layout Sync and IME Improvement | Disabled | Applies only to 1912 LTSR CU2 and later. |
| Enable Unicode Keyboard Layout Mapping | Prohibited | Applies only to 1912 LTSR CU2 and later. |
| Hide Keyboard Layout Switch Pop-up Message Box | Prohibited | Applies only to 1912 LTSR CU2 and later. |

ICA/Local App Access

| Name | Default setting | VDA |
|------------------------|-----------------|---|
| Allow Local App Access | Prohibited | VDA for Multi-session OS 7 through current, VDA for Single-session OS 7 through current |

| Name | Default setting | VDA |
|----------------------------|------------------------|---|
| URL redirection block list | No sites are specified | VDA for Multi-session OS 7 through current, VDA for Single-session OS 7 through current |
| URL redirection allow list | No sites are specified | VDA for Multi-session OS 7 through current, VDA for Single-session OS 7 through current |

ICA/Mobile experience

| Name | Default setting | VDA |
|--------------------------------|-----------------|---|
| Automatic keyboard display | Prohibited | VDA 5.6 FP1, VDA for Multi-session OS 7 through current, VDA for Single-session OS 7 through current |
| Launch touch-optimized desktop | Allowed | VDA 5.6 FP1, VDA for Multi-session OS 7 through current, VDA for Single-session OS 7 through current. This setting is disabled and not available for Windows 10 and Windows Server 2016 machines. |
| Remote the combo box | Prohibited | VDA 5.6 FP1, VDA for Multi-session OS 7 through current, VDA for Single-session OS 7 through current |

ICA/Multimedia

| Name | Default setting | VDA |
|-------------------------|-----------------|--------------------------|
| HTML5 video redirection | Prohibited | VDA 7.12 through current |

| Name | Default setting | VDA |
|--|-----------------|--|
| Limit video quality | Not configured | VDA for Multi-session OS 7 through current, VDA for Single-session OS 7 through current |
| Microsoft Teams redirection | Allowed | VDA for Multi-session OS 1906 through current, VDA for Single-session OS 1906 through current. |
| Multimedia conferencing | Allowed | All VDA versions |
| Optimization for Windows Media multimedia redirection over WAN | Allowed | VDA for Multi-session OS 7 through current, VDA for Single-session OS 7 through current |
| Use GPU for optimizing Windows Media multimedia redirection over WAN | Prohibited | VDA for Multi-session OS 7 through current, VDA for Single-session OS 7 through current |
| Windows Media fallback prevention | Not configured | VDA 7.6 FP3 through current |
| Windows Media client-side content fetching | Allowed | VDA for Multi-session OS 7 through current, VDA for Single-session OS 7 through current |
| Windows Media redirection | Allowed | All VDA versions |
| Windows Media redirection buffer size | 5 seconds | VDA 5, 5.5, 5.6 FP1 through current |
| Windows Media redirection buffer size use | Disabled | VDA 5, 5.5, 5.6 FP1 through current |

ICA/Multi-Stream Connections

| Name | Default setting | VDA |
|----------------|-----------------|--|
| Audio over UDP | Allowed | VDA for Multi-session OS 7 through current |

| Name | Default setting | VDA |
|--|--|---|
| Audio UDP port range | 16500, 16509 | VDA 5.5, 5.6 FP1, VDA for Multi-session OS 7 through current, VDA for Single-session OS 7 through current |
| Multi-Port policy | Primary port (2598) has High Priority | VDA 5.5, 5.6 FP1, VDA for Multi-session OS 7 through current, VDA for Single-session OS 7 through current |
| Multi-Stream computer setting | Disabled | VDA 5.5, 5.6 FP1, VDA for Multi-session OS 7 through current, VDA for Single-session OS 7 through current |
| Multi-Stream user setting | Disabled | VDA 5.5, 5.6 FP1, VDA for Multi-session OS 7 through current, VDA for Single-session OS 7 through current |
| Multi-Stream virtual channel stream assignment setting | See Multi-Stream virtual channel assignment setting for default stream assignments | VDA 2003 |

ICA/Port Redirection

| Name | Default setting | VDA |
|-------------------------------|-----------------|--|
| Auto connect client COM ports | Disabled | All VDA versions; for VDA 7.0 through 7.8, configure this setting using the registry |
| Auto connect client LPT ports | Disabled | All VDA versions; for VDA 7.0 through 7.8, configure this setting using the registry |
| Client COM port redirection | Prohibited | All VDA versions; for VDA 7.0 through 7.8, configure this setting using the registry |
| Client LPT port redirection | Prohibited | All VDA versions; for VDA 7.0 through 7.8, configure this setting using the registry |

ICA/Printing

| Name | Default setting | VDA |
|--|---|------------------|
| Client printer redirection | Allowed | All VDA versions |
| Default printer | Set default printer to the client's main printer | All VDA versions |
| Printer assignments | User's current printer is used as the default printer for the session | All VDA versions |
| Printer auto-creation event log preference | Log errors and warnings | All VDA versions |
| Session printers | No printers are specified | All VDA versions |
| Wait for printers to be created (desktop) | Disabled | All VDA versions |

ICA/Printing/Client Printers

| Name | Default setting | VDA |
|--|---|---------------------|
| Auto-create client printers | Auto-create all client printers | All VDA versions |
| Auto-create generic universal printer | Disabled | All VDA versions |
| Client printer names | Standard printer names | VDA 5.6 |
| Direct connections to print servers | Enabled | All VDA versions |
| Printer driver mapping and compatibility | No rules are specified | All VDA versions |
| Printer properties retention | Held in profile only if not saved on client | All VDA versions |
| Retained and restored client printers | Allowed | VDA 5, 5.5, 5.6 FP1 |

ICA/Printing/Drivers

| Name | Default setting | VDA |
|--|--|------------------|
| Automatic installation of in-box printer drivers | Enabled | All VDA versions |
| Universal driver preference | EMF; XPS; PCL5c; PCL4; PS | All VDA versions |
| Universal print driver usage | Use universal printing only if requested driver is unavailable | All VDA versions |

ICA/Printing/Universal Print Server

| Name | Default setting | VDA |
|--|-----------------|----------------------------------|
| Universal Print Server enable | Disabled | All VDA versions |
| Universal Print Server print data stream (CGP) port | 7229 | All VDA version |
| Universal Print Server print stream input bandwidth limit (kbps) | 0 | All VDA versions |
| Universal Print Server web service (HTTP/SOAP) port | 8080 | All VDA versions |
| Universal Print Servers for load balancing | | VDA versions 7.9 through current |
| Universal Print Server out-of-service threshold | 180 (seconds) | VDA versions 7.9 through current |

ICA/Printing/Universal Printing

| Name | Default setting | VDA |
|--|-------------------------------------|------------------|
| Universal printing EMF processing mode | Spool directly to printer | All VDA versions |
| Universal printing image compression limit | Best quality (lossless compression) | All VDA versions |

| Name | Default setting | VDA |
|--|--|------------------|
| Universal printing optimization defaults | Image Compression: Desired image quality = Standard quality, Enable heavyweight compression = False; Image and Font Caching: Allow caching of embedded images = True; Allow non-administrators to modify these settings = False; | All VDA versions |
| Universal printing preview preference | Do not use print preview for auto-created or generic universal printers | All VDA versions |
| Universal printing print quality limit | No limit | All VDA versions |

ICA/Security

| Name | Default setting | VDA |
|------------------------------------|-----------------|--|
| SecureICA minimum encryption level | Basic | VDA for Multi-session OS 7 through current |

ICA/Server Limits

| Name | Default setting | VDA |
|----------------------------|-----------------|--|
| Server idle timer interval | 0 milliseconds | VDA for Multi-session OS 7 through current |

ICA/Session Limits

| Name | Default setting | VDA |
|---|-----------------|--|
| Disconnected session timer | Disabled | VDA 5, 5.5, 5.6 FP1, VDA for Single-session OS 7 through current |
| Remote PC Access disconnected session timer | Disabled | VDA for Single-session OS 7 through current |
| Disconnected session timer interval | 1,440 minutes | VDA 5, 5.5, 5.6 FP1, VDA for Single-session OS 7 through current |
| Session connection timer | Disabled | VDA 5, 5.5, 5.6 FP1, VDA for Single-session OS 7 through current |
| Session connection timer interval | 1,440 minutes | VDA 5, 5.5, 5.6 FP1, VDA for Single-session OS 7 through current |
| Session idle timer | Enabled | VDA 5, 5.5, 5.6 FP1, VDA for Single-session OS 7 through current |
| Session idle timer interval | 1,440 minutes | VDA 5, 5.5, 5.6 FP1, VDA for Single-session OS 7 through current |

ICA/Session Reliability

| Name | Default setting | VDA |
|---------------------------------|-----------------|------------------|
| Session reliability connections | Allowed | All VDA versions |
| Session reliability port number | 2598 | All VDA versions |
| Session reliability timeout | 180 seconds | All VDA versions |

ICA/Time Zone Control

| Name | Default setting | VDA |
|--|-----------------|--|
| Estimate local time for legacy clients | Enabled | VDA for Multi-session OS 7 through current |

| Name | Default setting | VDA |
|---|----------------------|---------------------|
| Restore Single-session OS time zone on session disconnect or logoff | Enabled | Current VDA version |
| Use local time of client | Use server time zone | All VDA versions |

ICA/TWAIN Devices

| Name | Default setting | VDA |
|---------------------------------|-----------------|---|
| Client TWAIN device redirection | Allowed | VDA 5.5, 5.6 FP1, VDA for Multi-session OS 7 through current, VDA for Single-session OS 7 through current |
| TWAIN compression level | Medium | VDA 5.5, 5.6 FP1, VDA for Multi-session OS 7 through current, VDA for Single-session OS 7 through current |

ICA/USB Devices

| Name | Default setting | VDA |
|---|--|---|
| Client USB device optimization rules | Enabled (VDA 7.6 FP3 through current); Disabled (VDA 7.11 through current); By default, no rules are specified | VDA 7.6 FP3 through current |
| Client USB device redirection | Prohibited | All VDA versions |
| Client USB device redirection rules | No rules are specified | All VDA versions |
| Client USB Plug and Play device redirection | Allowed | VDA for Multi-session OS 7 through current, VDA for Single-session OS 7 through current |

ICA/Visual Display

| Name | Default setting | VDA |
|---|-------------------|---|
| Preferred color depth for simple graphics | 24 bits per pixel | VDA 7.6 FP3 through current |
| Target frame rate | 30 fps | All VDA versions |
| Visual quality | Medium | VDA for Multi-session OS 7 through current, VDA for Single-session OS 7 through current |

ICA/Visual Display/Moving Images

| Name | Default setting | VDA |
|---|--------------------|---|
| Minimum image quality | Normal | VDA 5.5, 5.6 FP1, VDA for Multi-session OS 7 through current, VDA for Single-session OS 7 through current |
| Moving image compression | Enabled | VDA 5.5, 5.6 FP1, VDA for Multi-session OS 7 through current, VDA for Single-session OS 7 through current |
| Progressive compression level | None | VDA 5.5, 5.6 FP1, VDA for Multi-session OS 7 through current, VDA for Single-session OS 7 through current |
| Progressive compression threshold value | 2,147,483,647 Kbps | VDA 5.5, 5.6 FP1, VDA for Multi-session OS 7 through current, VDA for Single-session OS 7 through current |
| Target minimum frame rate | 10 fps | VDA 5.5, 5.6 FP1, VDA for Multi-session OS 7 through current, VDA for Single-session OS 7 through current |

Note:

The **Target minimum frame rate** policy has been deprecated.

ICA/Visual Display/Still Images

| Name | Default setting | VDA |
|-----------------------------------|--------------------|------------------|
| Extra color compression | Disabled | All VDA versions |
| Extra color compression threshold | 8,192 Kbps | All VDA versions |
| Heavyweight compression | Disabled | All VDA versions |
| Lossy compression level | Medium | All VDA versions |
| Lossy compression threshold value | 2,147,483,647 Kbps | All VDA versions |

ICA/WebSockets

| Name | Default setting | VDA |
|---------------------------------------|---|---|
| WebSockets connections | Prohibited | VDA for Multi-session OS 7 through current, VDA for Single-session OS 7 through current |
| WebSockets port number | 8008 | VDA for Multi-session OS 7 through current, VDA for Single-session OS 7 through current |
| WebSockets trusted origin server list | The wildcard, *, is used to trust all Receiver for Web URLs | VDA for Multi-session OS 7 through current, VDA for Single-session OS 7 through current |

Load Management

| Name | Default setting | VDA |
|-------------------------------------|---------------------|--|
| Concurrent logon tolerance | 2 | VDA for Multi-session OS 7 through current |
| CPU usage | Disabled | VDA for Multi-session OS 7 through current |
| CPU usage excluded process priority | Below Normal or Low | VDA for Multi-session OS 7 through current |
| Disk usage | Disabled | VDA for Multi-session OS 7 through current |
| Maximum number of sessions | 250 | VDA for Multi-session OS 7 through current |
| Memory usage | Disabled | VDA for Multi-session OS 7 through current |
| Memory usage base load | Zero load: 768 MB | VDA for Multi-session OS 7 through current |

Profile Management/Advanced settings

| Name | Default setting | VDA |
|---|-----------------|------------------|
| Disable automatic configuration | Disabled | All VDA versions |
| Log off user if a problem is encountered | Disabled | All VDA versions |
| Number of retries when accessing locked files | 5 | All VDA versions |
| Process Internet cookie files on logoff | Disabled | All VDA versions |

Profile Management/Basic settings

| Name | Default setting | VDA |
|---------------------------|-----------------|------------------|
| Active write back | Disabled | All VDA versions |
| Enable Profile Management | Disabled | All VDA versions |

| Name | Default setting | VDA |
|--|---|------------------|
| Excluded groups | Disabled. Members of all user groups are processed. | All VDA versions |
| Offline profile support | Disabled | All VDA versions |
| Path to user store | Windows | All VDA versions |
| Process logons of local administrators | Disabled | All VDA versions |
| Processed groups | Disabled. Members of all user groups are processed. | All VDA versions |

Profile Management/Cross-Platform Settings

| Name | Default setting | VDA |
|---|---|------------------|
| Cross-platform settings user groups | Disabled. All user groups specified in Processed groups are processed | All VDA versions |
| Enable cross-platform settings | Disabled | All VDA versions |
| Path to cross-platform definitions | Disabled. No path is specified. | All VDA versions |
| Path to cross-platform settings store | Disabled. Windows\PM_CM is used. | All VDA versions |
| Source for creating cross-platform settings | Disabled | All VDA versions |

Profile Management/File System/Exclusions

| Name | Default setting | VDA |
|------------------------------|---|------------------|
| Exclusion list - directories | Disabled. All folders in the user profile are synchronized. | All VDA versions |
| Exclusion list - files | Disabled. All files in the user profile are synchronized. | All VDA versions |

Profile Management/File System/Synchronization

| Name | Default setting | VDA |
|----------------------------|---|------------------|
| Directories to synchronize | Disabled. Only non-excluded folders are synchronized. | All VDA versions |
| Files to synchronize | Disabled. Only non-excluded files are synchronized. | All VDA versions |
| Folders to mirror | Disabled. No folders are mirrored. | All VDA versions |

Profile Management/Folder Redirection

| Name | Default setting | VDA |
|----------------------------|-----------------|------------------|
| Grant administrator access | Disabled | All VDA versions |
| Include domain name | Disabled | All VDA versions |

Profile Management/Folder Redirection/AppData(Roaming)

| Name | Default setting | VDA |
|---|--|------------------|
| AppData(Roaming) path | Disabled. No location is specified. | All VDA versions |
| Redirection settings for AppData(Roaming) | Contents are redirected to the UNC path specified in the AppData(Roaming) path policy settings | All VDA versions |

Profile Management/Folder Redirection/Contacts

| Name | Default setting | VDA |
|-----------------------------------|---|------------------|
| Contacts path | Disabled. No location is specified. | All VDA versions |
| Redirection settings for Contacts | Contents are redirected to the UNC path specified in the Contacts path policy settings | All VDA versions |

Profile Management/Folder Redirection/Desktop

| Name | Default setting | VDA |
|----------------------------------|--|------------------|
| Desktop path | Disabled. No location is specified. | All VDA versions |
| Redirection settings for Desktop | Contents are redirected to the UNC path specified in the Desktop path policy settings | All VDA versions |

Profile Management/Folder Redirection/Documents

| Name | Default setting | VDA |
|------------------------------------|--|------------------|
| Documents path | Disabled. No location is specified. | All VDA versions |
| Redirection settings for Documents | Contents are redirected to the UNC path specified in the Documents path policy settings | All VDA versions |

Profile Management/Folder Redirection/Downloads

| Name | Default setting | VDA |
|------------------------------------|--|------------------|
| Downloads path | Disabled. No location is specified. | All VDA versions |
| Redirection settings for Downloads | Contents are redirected to the UNC path specified in the Downloads path policy settings | All VDA versions |

Profile Management/Folder Redirection/Favorites

| Name | Default setting | VDA |
|------------------------------------|--|------------------|
| Favorites path | Disabled. No location is specified. | All VDA versions |
| Redirection settings for Favorites | Contents are redirected to the UNC path specified in the Favorites path policy settings | All VDA versions |

Profile Management/Folder Redirection/Links

| Name | Default setting | VDA |
|--------------------------------|--|------------------|
| Links path | Disabled. No location is specified. | All VDA versions |
| Redirection settings for Links | Contents are redirected to the UNC path specified in the Links path policy settings | All VDA versions |

Profile Management/Folder Redirection/Music

| Name | Default setting | VDA |
|--------------------------------|--|------------------|
| Music path | Disabled. No location is specified. | All VDA versions |
| Redirection settings for Music | Contents are redirected to the UNC path specified in the Music path policy settings | All VDA versions |

Profile Management/Folder Redirection/Pictures

| Name | Default setting | VDA |
|---------------|-------------------------------------|------------------|
| Pictures path | Disabled. No location is specified. | All VDA versions |

| Name | Default setting | VDA |
|-----------------------------------|---|------------------|
| Redirection settings for Pictures | Contents are redirected to the UNC path specified in the Pictures path policy settings | All VDA versions |

Profile Management/Folder Redirection/Saved Games

| Name | Default setting | VDA |
|--------------------------------------|--|------------------|
| Saved Games path | Disabled. No location is specified. | All VDA versions |
| Redirection settings for Saved Games | Contents are redirected to the UNC path specified in the Saved Games path policy settings | All VDA versions |

Profile Management/Folder Redirection/Searches

| Name | Default setting | VDA |
|-----------------------------------|---|------------------|
| Searches path | Disabled. No location is specified. | All VDA versions |
| Redirection settings for Searches | Contents are redirected to the UNC path specified in the Searches path policy settings | All VDA versions |

Profile Management/Folder Redirection/Start Menu

| Name | Default setting | VDA |
|-------------------------------------|--|------------------|
| Start Menu path | Disabled. No location is specified. | All VDA versions |
| Redirection settings for Start Menu | Contents are redirected to the UNC path specified in the Start Menu path policy settings | All VDA versions |

Profile Management/Folder Redirection/Video

| Name | Default setting | VDA |
|--------------------------------|--|------------------|
| Video path | Disabled. No location is specified. | All VDA versions |
| Redirection settings for Video | Contents are redirected to the UNC path specified in the Video path policy settings | All VDA versions |

Profile Management/Log settings

| Name | Default setting | VDA |
|-----------------------------------|--|------------------|
| Active Directory actions | Disabled | All VDA versions |
| Common information | Disabled | All VDA versions |
| Common warnings | Disabled | All VDA versions |
| Enable logging | Disabled | All VDA versions |
| File system actions | Disabled | All VDA versions |
| File system notifications | Disabled | All VDA versions |
| Logoff | Disabled | All VDA versions |
| Logon | Disabled | All VDA versions |
| Maximum size of the log file | 1048576 | All VDA versions |
| Path to log file | Disabled. Log files are saved in the default location; %System-Root%\System32\Logfiles\UserProfileManager. | All VDA versions |
| Personalized user information | Disabled | All VDA versions |
| Policy values at logon and logoff | Disabled | All VDA versions |
| Registry actions | Disabled | All VDA versions |
| Registry differences at logoff | Disabled | All VDA versions |

Profile Management/Profile handling

| Name | Default setting | VDA |
|--|---|------------------|
| Delay before deleting cached profiles | 0 | All VDA versions |
| Delete locally cached profiles on logoff | Disabled | All VDA versions |
| Local profile conflict handling | Use local profile | All VDA versions |
| Migration of existing profiles | Local and roaming | All VDA versions |
| Path to the template profile | Disabled. New user profiles are created from the default user profile on the device where a user first logs on. | All VDA versions |
| Template profile overrides local profile | Disabled | All VDA versions |
| Template profile overrides roaming profile | Disabled | All VDA versions |
| Template profile used as a Citrix mandatory profile for all logons | Disabled | All VDA versions |

Profile Management/Registry

| Name | Default setting | VDA |
|----------------|--|------------------|
| Exclusion list | Disabled. All registry keys in the HKCU hive are processed when a user logs off. | All VDA versions |
| Inclusion list | Disabled. All registry keys in the HKCU hive are processed when a user logs off. | All VDA versions |

Profile Management/Streamed user profiles

| Name | Default setting | VDA |
|-------------------|-----------------|------------------|
| Always cache | Disabled | All VDA versions |
| Always cache size | 0 Mb | All VDA versions |

| Name | Default setting | VDA |
|--|--|------------------|
| Profile streaming | Disabled | All VDA versions |
| Streamed user profile groups | Disabled. All user profiles within an OU are processed normally. | All VDA versions |
| Timeout for pending area lock files (days) | 1 day | All VDA versions |

Receiver

| Name | Default setting | VDA |
|--------------------------|-------------------------|---|
| StoreFront accounts list | No stores are specified | VDA for Multi-session OS 7 through current, VDA for Single-session OS 7 through current |

User personalization layer

| Name | Default setting | VDA |
|----------------------------|--|------------------------------|
| User Layer Repository Path | Disabled. No path specified. | VDA 19.12 and later versions |
| User Layer Size in GB | 10 GB. A user layer is a thin-provisioned disk that expands to the set size. User layers never decrease in size. | VDA 19.12 or later versions |

Virtual Delivery Agent

| Name | Default setting | VDA |
|--------------------------------------|-------------------------|---|
| Controller registration IPv6 netmask | No netmask is specified | VDA for Multi-session OS 7 through current, VDA for Single-session OS 7 through current |

| Name | Default setting | VDA |
|---------------------------------------|------------------------------|---|
| Controller registration port | 80 | All VDA versions |
| Controller SIDs | No SIDs are specified | All VDA versions |
| Controllers | No controllers are specified | All VDA versions |
| Enable auto update of controllers | Enabled | VDA for Multi-session OS 7 through current, VDA for Single-session OS 7 through current |
| Only use IPv6 controller registration | Disabled | VDA for Multi-session OS 7 through current, VDA for Single-session OS 7 through current |
| Site GUID | No GUID is specified | All VDA versions |

Virtual Delivery Agent/HDX 3D Pro

| Name | Default setting | VDA |
|-----------------------------|-----------------|------------------|
| Enable lossless | Enabled | VDA 5.5, 5.6 FP1 |
| HDX 3D Pro quality settings | | VDA 5.5, 5.6 FP1 |

Virtual Delivery Agent/Monitoring

| Name | Default setting | VDA |
|----------------------------|-----------------|--------------------------|
| Enable process monitoring | Disabled | VDA 7.11 through current |
| Enable resource monitoring | Enabled | VDA 7.11 through current |

Virtual IP

| Name | Default setting | VDA |
|-----------------------------|-----------------|-------------------------|
| Virtual IP loopback support | Disabled | VDA 7.6 through current |

| Name | Default setting | VDA |
|---|-----------------|-------------------------|
| Virtual IP virtual loopback programs list | None | VDA 7.6 through current |

Policy settings reference

May 27, 2022

Policies include settings that are applied when the policy is enforced. Descriptions in this section also indicate if more settings are required to enable a feature or are similar to a setting.

Quick reference

The following tables list the settings that you can configure within a policy. Find the task that you want to complete in the left column, then locate its corresponding setting in the right column.

A full listing of all policy settings is available in .CHM (Compiled HTML) format and .CSV format. These files are available in the `\program files\citrix\grouppolicy` folder on the server where the broker (delivery controller) is installed. You can also download the latest version of the policy settings by clicking [here](#).

Audio

| For this task | Use this policy setting |
|--|-------------------------------|
| Control whether to allow the use of multiple audio devices | Audio Plug N Play |
| Control whether to allow audio input from microphones on the user device | Client microphone redirection |
| Control audio quality on the user device | Audio quality |
| Control audio mapping to speakers on the user device | Client audio redirection |

Bandwidth for user devices

| To limit bandwidth used for | Use this policy setting |
|---|--|
| Client audio mapping | Audio redirection bandwidth limit or Audio redirection bandwidth limit percent |
| Cut-and-paste using a local clipboard | Clipboard redirection bandwidth limit or Clipboard redirection bandwidth limit percent |
| Access in a session to local client drives | File redirection bandwidth limit or File redirection bandwidth limit percent |
| HDX MediaStream Multimedia Acceleration | HDX MediaStream Multimedia Acceleration bandwidth limit or HDX MediaStream Multimedia Acceleration bandwidth limit percent |
| Client session | Overall session bandwidth limit |
| Printing | Printer redirection bandwidth limit or Printer redirection bandwidth limit percent |
| TWAIN devices (such as a camera or scanner) | TWAIN device redirection bandwidth limit or TWAIN device redirection bandwidth limit percent |
| USB devices | Client USB device redirection bandwidth limit or Client USB device redirection bandwidth limit percent |

Redirection of client drives and user devices

| For this task | Use this policy setting |
|--|--|
| Control whether drives on the user device are connected when users log on to the server or not | Auto connect client drives |
| Control cut-and-paste data transfer between the server and the local clipboard | Client clipboard redirection |
| Control how drives map from the user device | Client drive redirection |
| Control whether users' local hard drives are available in a session | Client fixed drives and Client drive redirection |
| Control whether users' local floppy drives are available in a session | Client floppy drives and Client drive redirection |
| Control whether users' network drives are available in a session | Client network drives and Client drive redirection |

| For this task | Use this policy setting |
|--|---|
| Control whether users' local CD, DVD, or Blu-ray drives are available in a session | Client optical drives and Client drive redirection |
| Control whether users' local removable drives are available in a session | Client removable drives and Client drive redirection |
| Control whether users' TWAIN devices, such as scanners and cameras, are available in a session and control compression of image data transfers | Client TWAIN device redirection; TWAIN compression redirection |
| Control whether USB devices are available in a session | Client USB device redirection and Client USB device redirection rules |
| Improve the speed of writing and copying files to a client disk over a WAN | Use asynchronous writes |

Content redirection

| For this task | Use this policy setting |
|---|----------------------------|
| Control whether to use content redirection from the server to the user device | Host to client redirection |

Desktop UI

| For this task | Use this policy setting |
|---|-------------------------------------|
| Control whether Desktop wallpaper is used in users' sessions or not | Desktop wallpaper |
| View window contents while a window is dragged | View window contents while dragging |

Graphics and multimedia

Important:

The Flash policy remains only to allow customers with older VDAs to use newer controllers (for example, version 1912 controllers) and still use Flash. This VDA version does not support Flash.

| For this task | Use this policy setting |
|--|--|
| Control the maximum number of frames per second sent to user devices from virtual desktops | Target frame rate |
| Control the visual quality of images displayed on the user device | Visual quality |
| Control whether websites can display Flash content when accessed in sessions | Flash server-side content fetching URL list; Flash URL compatibility list; Flash video fallback prevention policy setting; Flash video fallback prevention error *.swf |
| Control compression of server-rendered video | Use video codec for compression; Use hardware encoding for video codec |
| Control the delivery of HTML5 multimedia web content to users | HTML5 video redirection |

Prioritize Multi-Stream network traffic

| For this task | Use this policy setting |
|--|---|
| Specify ports for ICA traffic across multiple connections and establish network priorities | Multi-Port policy |
| Enable support for multi-stream connections among servers and user devices | Multi-Stream (computer and user settings) |

Print

| For this task | Use this policy setting |
|---|--|
| Control creation of client printers on the user device | Auto-create client printers and Client printer redirection |
| Control the location where printer properties are stored | Printer properties retention |
| Control whether the client or the server processes the print requests | Direct connections to print servers |
| Control whether users can access printers connected to their user devices | Client printer redirection |

| For this task | Use this policy setting |
|--|---|
| Control installation of native Windows drivers when automatically creating client and network printers | Automatic installation of in-box printer drivers |
| Control when to use the Universal Printer Driver | Universal print driver usage |
| Choose a printer based on a roaming user session information | Default printer |
| Load balance and set failover threshold for Universal Print Servers | Universal Print Servers for load balancing;
Universal Print Servers out-of-service threshold |

Note:

Policies cannot be used to enable a screen saver in a desktop or application session. For users who require screen savers, the screen saver can be implemented on the user device.

ICA policy settings

April 10, 2024

Note:

This page provides you descriptions and supported configuration values for ICA policy settings. For more information on working with policies, see [Work with policies](#) section.

Adaptive transport

This setting allows or prevents data transport over EDT as primary and over TCP as fallback.

By default, adaptive transport is enabled (**Preferred**), and EDT is used when possible, with fallback to TCP. You can change its setting as needed:

- **Preferred.** Adaptive transport over EDT is used when possible, with fallback to TCP.
- **Diagnostic mode.** EDT is forced on and fallback to TCP is disabled. We recommend this setting only for troubleshooting.
- **Off.** TCP is forced on, and EDT is disabled.

For more information, see [Adaptive transport](#).

Drag and drop setting

This setting allows or prevents the dragging of files between the client and virtual applications or desktops. By default, the drag and drop policy is disabled. You can enable this policy if needed.

Application launch wait timeout

This setting specifies the wait timeout value in milliseconds for a session to wait for the first application to start. If the start of the application exceeds this time period, the session ends.

You can choose the default time (10,000 milliseconds) or specify a number in milliseconds.

Client clipboard redirection

This setting allows or prevents the clipboard on the user device being mapped to the clipboard on the server.

By default, clipboard redirection is allowed.

To prevent copy-and-paste data transfer between a session and the local clipboard, select **Prohibit**. Users can still copy and paste data between applications running in sessions.

After allowing this setting, configure the maximum allowed bandwidth the clipboard can consume in a client connection. Use the **Clipboard redirection bandwidth limit** or the **Clipboard redirection bandwidth limit percent** settings.

Client clipboard write allowed formats

When the **Restrict client clipboard write** setting is **Enabled**, host clipboard data cannot be shared with the client endpoint. You can use this setting to allow specific data formats to be shared with the client endpoint clipboard. To use this setting, enable it and add the specific formats to be allowed.

The following clipboard formats are system defined:

- CF_TEXT
- CF_BITMAP
- CF_METAFILEPICT
- CF_SYLK
- CF_DIF
- CF_TIFF
- CF_OEMTEXT
- CF_DIB
- CF_PALETTE

- CF_PENDATA
- CF_RIFF
- CF_WAVE
- CF_UNICODETEXT
- CF_ENHMETAFILE
- CF_HDROP
- CF_LOCALE
- CF_DIBV5
- CF_OWNERDISPLAY
- CF_DSPTEXT
- CF_DSPBITMAP
- CF_DSPMETAFILEPICT
- CF_DISPENHMETAFILE
- CF_HTML

The following custom formats are predefined in XenApp and XenDesktop and Citrix Virtual Apps and Desktops:

- CFX_RICHTEXT
- CFX_OfficeDrawingShape
- CFX_BIFF8
- CFX_FILE

HTML format is disabled by default. To enable this feature:

- Verify that **Client clipboard redirection** is set to **Allowed**.
- Verify that **Restrict client clipboard write** is set to **Enabled**.
- Add an entry for **CF_HTML** (and any other formats that you want supported) in **Client clipboard write allowed formats**.

You can add more custom formats. The custom format name must match the formats to be registered with the system. Format names are case-sensitive.

This setting does not apply if the **Client clipboard redirection** policy is set to **Prohibited** or the **Restrict client clipboard write** policy is set to **Disabled**.

Note:

Enabling HTML format clipboard copy support (CF_HTML) copies any scripts from the source of the copied content to the destination. Check that you trust the source before proceeding to copy. If you do copy content containing scripts, they are live only if you save the destination file as an HTML file and run it.

Limit clipboard client to session transfer size

This setting specifies the maximum size of clipboard data that a user can transfer from a client endpoint to a virtual session during a single copy-and-paste operation.

To limit clipboard transfer size, enable the **Limit clipboard client to session transfer size** setting. Then, in the **Size Limit** field, enter a value in kilobytes to define the size of data transfer between the local clipboard and a session.

By default, this setting is disabled and there's no limit on client to session transfers.

HDX Direct

HDX Direct allows the client to automatically establish a direct connection with the session host when direct communication is available. Connections are established securely using network-level encryption.

HDX Direct mode

HDX Direct can be used to establish direct connections with session hosts for internal and external clients. This setting determines if HDX Direct is available for internal clients only or for both internal and external clients.

When set to **Internal** only, HDX Direct attempts to establish direct connections for clients in the internal network only.

When set to **Internal** and **external**, HDX Direct attempts to establish direct connections for internal and external clients.

By default, HDX Direct is set for internal clients only.

HDX Direct port range

The range of ports that are used by HDX Direct for connections from external users.

By default, HDX Direct uses the port range: 55000–55250.

Limit clipboard session to client transfer size

This setting specifies the maximum size of clipboard data that a user can transfer from a virtual session to a client endpoint during a single copy-and-paste operation.

To limit clipboard transfer size, enable the **Limit clipboard session to client transfer size** setting. Then, in the **Size Limit** field, enter a value in kilobytes to define the size of data transfer between a session and the local clipboard.

By default, this setting is disabled and there's no limit on session to client transfers.

Restrict client clipboard write

If this setting is **Enabled**, host clipboard data cannot be shared with the client endpoint. You can allow specific formats by enabling the **Client clipboard write allowed formats** setting.

By default, this setting is **Disabled**.

Restrict session clipboard write

When this setting is **Enabled**, client clipboard data cannot be shared within the user session. You can allow specific formats by enabling the **Session clipboard write allowed formats** setting.

By default, this setting is **Disabled**.

Session clipboard write allowed formats

When the **Restrict session clipboard write** setting is **Enabled**, client clipboard data cannot be shared with session applications. You can use this setting to allow specific data formats to be shared with the session clipboard.

The following clipboard formats are system defined:

- CF_TEXT
- CF_BITMAP
- CF_METAFILEPICT
- CF_SYLK
- CF_DIF
- CF_TIFF
- CF_OEMTEXT
- CF_DIB
- CF_PALETTE
- CF_PENDATA
- CF_RIFF
- CF_WAVE
- CF_UNICODETEXT
- CF_ENHMETAFILE

- CF_HDROP
- CF_LOCALE
- CF_DIBV5
- CF_OWNERDISPLAY
- CF_DSPTEXT
- CF_DSPBITMAP
- CF_DSPMETAFILEPICT
- CF_DISPENHMETAFILE
- CF_HTML

The following custom formats are predefined in XenApp and XenDesktop and Citrix Virtual Apps and Desktops:

- CFX_RICHTEXT
- CFX_OfficeDrawingShape
- CFX_BIFF8

HTML format is disabled by default. To enable this feature:

- Verify that **Client clipboard redirection** is set to **Allowed**.
- Verify that **Restrict session clipboard write** is set to **Enabled**.
- Add an entry for **CF_HTML** (and any other formats that you want supported) in **Session clipboard write allowed formats**.

You can add more custom formats. The custom format name must match the formats to be registered with the system. Format names are case-sensitive.

This setting does not apply if the **Client clipboard redirection** policy is set to **Prohibited** or the **Restrict session clipboard write** policy is set to **Disabled**.

Note:

Enabling HTML format clipboard copy support (CF_HTML) copies any scripts from the source of the copied content to the destination. Check that you trust the source before proceeding to copy. If you do copy content containing scripts, they are live only if you save the destination file as an HTML file and run it.

Desktop starts

This setting allows or prevents connections to a session on that VDA using an ICA connection by non-administrative users in a VDA Direct Access Users group.

By default, non-administrative users can't connect to these sessions.

This setting doesn't affect non-administrative users in a VDA Direct Access Users group who are using an RDP connection. These users can connect to the VDA when this setting is enabled or disabled. This setting doesn't affect non-administrative users who aren't in a VDA Direct Access Users group. These users can't connect to the VDA when this setting is enabled or disabled.

FIDO2 redirection

This setting enables or disables FIDO2 redirection. FIDO2 redirection lets users take advantage of the local endpoint FIDO2 components in a virtual machine. Users can authenticate virtual session through FIDO2 security keys or integrated biometrics on devices that have TPM 2.0 and Windows Hello.

When this setting is **Allowed**, users can do FIDO2 authentication by using the local endpoint capabilities. By default, this setting is **Allowed**.

ICA listener connection timeout

This setting specifies the maximum wait time for a connection using the ICA protocol to be completed.

By default, the maximum wait time is 120,000 milliseconds, or two minutes.

ICA listener port number

This setting specifies the TCP/IP port number used by the ICA protocol on the server.

By default, the port number is set to 1494.

Valid port numbers must be in the range of 0-65535 and must not conflict with other well-known port numbers. If you change the port number, restart the server for the new value to take effect. If you change the port number on the server, you must also change it on every Citrix Workspace app or plugin that connects to the server.

Keyboard and Input Method Editor (IME)

This setting enables or disables the following:

- Dynamic keyboard layout synchronization
- Input Method Editor (IME)
- Unicode keyboard layout mapping
- Hides or shows the keyboard layout switch notification dialog message

1. In Web Studio, select **Keyboard and IME**.
2. Select **Client keyboard layout synchronization and IME improvement** to control the dynamic keyboard layout synchronization and generic client Input Method Editor (IME) features in the VDA. You can configure:
 - Disabled** - dynamic keyboard layout synchronization and generic client Input Method Editor (IME).
 - Support dynamic client keyboard layout synchronization** - enables dynamic keyboard layout synchronization.
 - Support dynamic client keyboard layout synchronization and IME improvement** - enables both dynamic keyboard layout synchronization and generic client Input Method Editor (IME).
3. Select **Enable Unicode keyboard layout mapping** to enable or disable Unicode keyboard mapping.
4. Select **Hide keyboard layout switch pop-up message box** to control whether or not a message appears, indicating that the keyboard layout is synchronizing when the user changes the client keyboard layout. If you prevent the message from appearing, the users must wait for a few moments before typing to avoid incorrect character input.

Default settings:

- **Client keyboard layout synchronization and IME improvement**
 - Disabled in Windows Server 2016 and Windows Server 2019.
 - Support dynamic client keyboard layout synchronization and IME improvement in Windows Server 2012 and Windows 2010.
- **Disable Unicode keyboard layout mapping**
- **Show keyboard layout switch pop-up message box**

This policy replaces the registry settings that are listed in the **Description** section of the policy settings.

Logoff checker startup delay

This setting specifies the duration to delay the logoff checker startup. Use this policy to set the time (in seconds) that a client session waits before disconnecting the session.

This setting also increases the time that it takes for a user to log off from the server.

Loss tolerant mode

Important:

- The feature requires a minimum of Citrix Workspace app 2002 for Windows. This version of the VDA supports it when it becomes available.
- Loss tolerant mode for graphics is not supported on Citrix Gateway or Citrix Gateway Service. This mode is available only with direct connections.

This setting enables or disables loss tolerant mode for graphics.

By default, loss tolerant mode for graphics is **Allowed**.

When allowed, the mode is entered when the packet loss and latency are above a threshold. You can set the thresholds using the loss tolerant thresholds policy.

Loss tolerant thresholds

When the [Loss tolerant mode](#) is available, this setting specifies the network metrics thresholds at which the session switches to loss tolerant mode for graphics.

The default thresholds are:

- Packet loss: 5%
- Latency: 300 ms (RTT)

For more information, see [loss tolerant mode](#).

Loss tolerant mode for audio

This setting enables or disables the loss tolerant mode for audio.

When enabled, audio is sent over the loss tolerant mode.

By default, loss tolerant mode for audio is **Prohibited**.

To enable the policy, edit the registry of the loss tolerant mode for audio policy to **Allowed**.

EDT transport is required to enable loss tolerant mode for audio.

Rendezvous protocol

This setting changes how HDX sessions are proxied when using the Citrix Gateway Service. When enabled, HDX traffic no longer flows through the Citrix Cloud Connector. Instead, the VDA establishes an outbound connection directly to the Citrix Gateway Service (enhancing Cloud Connector scalability).

Important:

A feature toggle in Citrix Cloud and an HDX policy setting controls this feature. The Citrix Cloud feature toggle is enabled by default while the HDX setting is disabled by default. The HDX setting affects only HDX sessions established through the Citrix Gateway Service. This setting does not affect sessions established directly between client and VDA or through an on-premises Citrix Gateway.

For information, see [Rendezvous protocol](#).

Rendezvous proxy configuration

This setting allows you to configure an explicit proxy for use with the Rendezvous protocol. If using a transparent proxy, this setting does not need to be enabled.

By default, this setting is disabled.

When disabled, the VDA doesn't route outbound traffic through any non-transparent proxies when trying to establish a Rendezvous connection with the Gateway Service.

When enabled, the VDA attempts to establish a Rendezvous connection with the Gateway Service through the proxy defined in this setting.

The VDA supports using HTTP and SOCKS5 proxies for Rendezvous connections. To configure the VDA to use a proxy for the Rendezvous connection, you must enable this setting. Also, specify either the address of the proxy or the path to the PAC file. For example:

- Proxy address: `http://<URL or IP>:<port>` or `socks5://<URL or IP>:<port>`
- PAC file: `http://<URL or IP>/<path>/<filename>.pac`

VDA version 2103 is the minimum supported version for proxy configuration with a PAC file. For more information on the PAC file schema for SOCKS5 proxies, see [Proxy configuration](#).

Note:

Only SOCKS5 proxies support data transport through EDT. For an HTTP proxy, use TCP as the transport protocol for ICA.

For more information, see [Rendezvous protocol](#).

Starting of non-published programs during client connection

This setting specifies whether to allow starting initial applications through RDP on the server.

By default, starting initial applications through RDP on the server isn't allowed.

Tablet mode toggle policy settings

Tablet mode toggle optimizes the look and behavior of Store apps, Win32 apps, and the Windows shell on the VDA. It does so by automatically toggling the virtual desktop to Tablet mode when connecting from small form factor devices like phones and tablets, or any touch-enabled device.

If this policy is disabled, the VDA is in the mode the user sets it to and maintains the same mode throughout, regardless of the type of client.

Auto client reconnect policy settings

March 7, 2023

The **Auto Client Reconnect** section contains policy settings for controlling the automatic reconnection of sessions.

Auto client reconnect

This setting allows or prevents automatic reconnection by the same client after a connection has been interrupted.

For Citrix Receiver for Windows 4.7 and later and Citrix Workspace app 1808 and later, auto client reconnect uses only the policy settings from Citrix Studio. Updates to these policies in Studio synchronize auto client reconnect from server to client. With older versions of Citrix Receiver for Windows, to configure auto client reconnect, use a Studio policy and change the registry or the default.ica file.

Allowing automatic client reconnect allows users to resume working where they were interrupted when a connection was broken. Automatic reconnection detects broken connections and then reconnects the users to their sessions.

If the Citrix Workspace app cookie containing the key to the session ID and credentials isn't used, automatic reconnection might result in a new session being started. That is, instead of reconnecting to an existing session. The cookie is not used if it has expired. For example, the cookie might expire because of a delay in reconnection, or if credentials must be reentered. If users intentionally disconnect, auto client reconnect is not triggered.

A session window is grayed out when a reconnection is in progress. A countdown timer displays the time remaining before the session is reconnected. When a session times out, it is disconnected.

For application sessions, when automatic reconnect is allowed, a countdown timer appears in the notification area. This timer specifies the time remaining before the session is reconnected. Citrix

Workspace app tries to reconnect to the session until there is a successful reconnection or the user cancels the reconnection attempts.

For user sessions, when automatic reconnect is allowed, Citrix Workspace app tries to reconnect to the session for a specified period, unless there's a successful reconnection or the user cancels the reconnection attempts. By default, this period is two minutes. To change this period, edit the policy.

By default, automatic client reconnect is allowed. You can disable it by setting the policy to **Prohibited**.

Auto client reconnect authentication

This setting specifies whether authentication is required for automatic client reconnections.

When a user initially logs on, the credentials are encrypted, stored in memory, and a cookie is created containing the encryption key. The cookie is sent to Citrix Workspace app. When this setting is configured, cookies are not used. Instead, a dialog box is displayed to users requesting credentials when Citrix Workspace app attempts to reconnect automatically.

By default, authentication is not required.

Auto client reconnect logging

This setting enables or disables recording of auto client reconnections in the event log.

When logging is enabled, the server System Log captures information about successful and failed automatic reconnection events. A site does not provide a combined log of reconnection events for all servers.

By default, logging is disabled.

Auto client reconnect timeout

By default, auto-client reconnect timeout is set to 120 seconds, the maximum configurable value for an auto-client reconnect timeout is 300 seconds. Use this policy to set the timeout value.

Reconnect UI transparency level

This setting lets you specify the opacity level applied to the XenApp or XenDesktop session window during session reliability reconnection time.

By default, Reconnect UI transparency is set to 80%.

Audio policy settings

March 24, 2023

The **Audio** section includes policy settings that allow user devices to send and receive audio in sessions without reducing performance.

Adaptive Audio

This setting enables or disables adaptive audio. When you enable this policy, the audio quality settings are adjusted dynamically to provide the best user experience. This setting applies to both single-session OS and multi-session OS sessions of VDAs using Citrix Virtual Apps and Desktops 2109 or later.

When this setting is prohibited, the audio quality policy is applied. For more information see, [Audio quality](#).

By default, the adaptive audio policy is enabled.

Audio over UDP real-time transport

This setting allows or prevents the transmission and receipt of audio between the VDA and user device over RTP using the User Datagram Protocol (UDP). When this setting is disabled, audio is sent and received over TCP.

By default, audio over UDP is allowed.

Audio Plug N Play

This setting allows or prevents the use of multiple audio devices to record and play sound.

By default, the use of multiple audio devices is allowed.

This setting applies only to Windows Multi-session OS machines.

Audio quality

This setting specifies the quality level of sound received in user sessions.

By default, sound quality is set to High - high definition audio.

To control sound quality, choose one of the following options:

- Select Low - for low speed connections for low-bandwidth connections. Sounds sent to the user device are compressed up to 16 Kbps. This compression results in a significant reduction in the quality of the sound. But also allows reasonable performance for a low-bandwidth connection.
- Select Medium - optimized for speech to deliver Voice over Internet Protocol applications. This setting delivers media applications in challenging network connections with lines less than 512 Kbps, or significant congestion and packet loss. This codec offers fast encode time, making it ideal for use with softphones and Unified Communications applications when you require server-side media processing.

Audio sent to the user device is compressed up to 64 Kbps. This compression results in a moderate reduction in the quality of the audio played on the user device while providing low latency and consuming low bandwidth. If Voice over Internet Protocol quality is unsatisfactory, ensure that the Audio over UDP Real-time Transport policy setting is set to Allowed.

Now, Real-time Transport (RTP) over UDP is only supported when this audio quality is selected. Use this audio quality even for delivering media applications for challenging network connections like low (fewer than 512 Kbps) lines. Also, when there is congestion and packet loss in the network.

- Select High - high definition audio for connections where bandwidth is plentiful and sound quality is important. Clients can play sound at its native rate. Sounds are compressed at a high quality level maintaining up to CD quality, and using up to 112 Kbps of bandwidth. Transmitting this amount of data can result in increased CPU usage and network congestion.

Bandwidth is consumed only while audio is recording or playing. If both occur at the same time, the bandwidth consumption doubles.

To specify the maximum amount of bandwidth, configure the **Audio redirection bandwidth limit** or the **Audio redirection bandwidth limit percent** settings.

Client audio redirection

This setting specifies whether applications hosted on the server can play sounds through a sound device installed on the user device. This setting also specifies whether users can record audio input.

By default, audio redirection is allowed.

After allowing this setting, you can limit the bandwidth consumed by playing or recording audio. Limiting the amount of bandwidth consumed by audio can improve application performance but might also degrade audio quality. Bandwidth is consumed only while audio is recording or playing. If both occur at the same time, the bandwidth consumption doubles. To specify the maximum amount of bandwidth, configure the **Audio redirection bandwidth limit** or the **Audio redirection bandwidth limit percent** settings.

On Windows Multi-session OS machines, ensure that the **Audio Plug N Play** setting is enabled to support multiple audio devices.

Important: Prohibiting Client audio redirection disables all HDX audio functionality.

Client microphone redirection

This setting enables or disables client microphone redirection. When enabled, users can use microphones to record audio input in a session.

By default, microphone redirection is allowed.

For security, users are alerted when untrusted servers by their devices try to access microphones. Users can choose to accept or not accept access. Users can disable the alert on Citrix Workspace app.

On Windows Multi-session OS machines, ensure that the Audio Plug N Play setting is Enabled to support multiple audio devices.

If the **Client audio redirection** setting is disabled on the user device, this rule has no effect.

Bandwidth policy settings

May 30, 2022

The **Bandwidth** section includes policy settings to avoid performance problems related to client session bandwidth use.

Important: Using these policy settings with the **Multi-Stream policy** settings might produce unexpected results. If you use Multi-Stream settings in a policy, ensure that these bandwidth limit policy settings aren't included.

Audio redirection bandwidth limit

This setting specifies the maximum allowed bandwidth for playing or recording audio in a user session. The maximum allowed bandwidth is specified in kilobits per second.

By default, no maximum (zero) is specified.

If you enter a value for this setting and a value for the **Audio redirection bandwidth limit percent** setting, the most restrictive setting (lower value) is applied.

Audio redirection bandwidth limit percent

This setting specifies the maximum allowed bandwidth limit for playing or recording audio as a percentage of the total session bandwidth.

By default, no maximum (zero) is specified.

If you enter a value for this setting and a value for the **Audio redirection bandwidth limit** setting, the most restrictive setting (the lower value) is applied.

If you configure this setting, you must also configure the **Overall session bandwidth limit** setting, which specifies the total amount of bandwidth available for client sessions.

Client USB device redirection bandwidth limit

This setting specifies the maximum allowed bandwidth for the redirection of USB devices to and from the client. The maximum allowed bandwidth is specified in kilobits per second.

By default, no maximum (zero) is specified.

If you enter a value for this setting and a value for the **Client USB device redirection bandwidth limit percent** setting, the most restrictive setting (the lower value) is applied.

Client USB device redirection bandwidth limit percent

This setting specifies the maximum allowed bandwidth for the redirection of USB devices to and from the client as a percentage of the total session bandwidth.

By default, no maximum (zero) is specified.

If you enter a value for this setting and a value for the **Client USB device redirection bandwidth limit** setting, the most restrictive setting (the lower value) is applied.

If you configure this setting, you must also configure the **Overall session bandwidth limit** setting, which specifies the total amount of bandwidth available for client sessions.

Clipboard redirection bandwidth limit

This setting specifies the maximum allowed bandwidth for data transfer between a session and the local clipboard. The maximum allowed bandwidth is specified in kilobits per second.

By default, no maximum (zero) is specified.

If you enter a value for this setting and a value for the **Clipboard redirection bandwidth limit percent** setting, the most restrictive setting (the lower value) is applied.

Clipboard redirection bandwidth limit percent

This setting specifies the maximum allowed bandwidth for data transfer between a session and the local clipboard as a percentage of the total session bandwidth.

By default, no maximum (zero) is specified.

If you enter a value for this setting and a value for the **Clipboard redirection bandwidth limit** setting, the most restrictive setting (the lower value) is applied.

If you configure this setting, you must also configure the **Overall session bandwidth limit** setting, which specifies the total amount of bandwidth available for client sessions.

COM port redirection bandwidth limit

Note: For the Virtual Delivery Agent 7.0 through 7.8, configure this setting using the registry; see [Configure COM Port and LPT Port Redirection settings using the registry](#).

This setting specifies the maximum allowed bandwidth in kilobits per second for accessing a COM port in a client connection. If you enter a value for this setting and a value for the **COM port redirection bandwidth limit percent** setting, the most restrictive setting (the lower value) is applied.

COM port redirection bandwidth limit percent

Note: For the Virtual Delivery Agent 7.0 through 7.8, configure this setting using the registry; see [Configure COM Port and LPT Port Redirection settings using the registry](#).

This setting specifies the maximum allowed bandwidth for accessing COM ports in a client connection as a percentage of the total session bandwidth.

By default, no maximum (zero) is specified

If you enter a value for this setting and a value for the **COM port redirection bandwidth limit** setting, the most restrictive setting (the lower value) is applied.

If you configure this setting, you must also configure the **Overall session bandwidth limit** setting, which specifies the total amount of bandwidth available for client sessions

File redirection bandwidth limit

This setting specifies the maximum allowed bandwidth for accessing a client drive in a user session. The maximum allowed bandwidth is specified in kilobits per second.

By default, no maximum (zero) is specified.

If you enter a value for this setting and a value for the **File redirection bandwidth limit percent** setting, the most restrictive setting (the lower value) takes effect.

File redirection bandwidth limit percent

This setting specifies the maximum allowed bandwidth limit for accessing client drives as a percentage of the total session bandwidth.

By default, no maximum (zero) is specified.

If you enter a value for this setting and a value for the **File redirection bandwidth limit** setting, the most restrictive setting (the lower value) is applied.

If you configure this setting, you must also configure the **Overall session bandwidth limit** setting, which specifies the total amount of bandwidth available for client sessions.

HDX MediaStream Multimedia Acceleration bandwidth limit

This setting specifies the maximum allowed bandwidth limit for delivering streaming audio and video using HDX MediaStream Multimedia Acceleration. The maximum allowed bandwidth is specified in kilobits per second.

By default, no maximum (zero) is specified.

If you enter a value for this setting and a value for the **HDX MediaStream Multimedia Acceleration bandwidth limit percent** setting, the most restrictive setting (the lower value) takes effect.

HDX MediaStream Multimedia Acceleration bandwidth limit percent

This setting specifies the maximum allowed bandwidth for delivering streaming audio and video using HDX MediaStream Multimedia Acceleration as a percentage of the total session bandwidth.

By default, no maximum (zero) is specified.

If you enter a value for this setting and a value for the **HDX MediaStream Multimedia Acceleration bandwidth limit** setting, the most restrictive setting (the lower value) takes effect.

If you configure this setting, you must also configure the **Overall session bandwidth limit** setting, which specifies the total amount of bandwidth available for client sessions.

LPT port redirection bandwidth limit

Note: For the Virtual Delivery Agent 7.0 through 7.8, configure this setting using the registry; see [Configure COM Port and LPT Port Redirection settings using the registry](#).

This setting specifies the maximum allowed bandwidth for print jobs using an LPT port in a single user session. The maximum allowed bandwidth is specified in kilobits per second.

By default, no maximum (zero) is specified.

If you enter a value for this setting and a value for the **LPT port redirection bandwidth limit percent** setting, the most restrictive setting (the lower value) is applied.

LPT port redirection bandwidth limit percent

Note: For the Virtual Delivery Agent 7.0 through 7.8, configure this setting using the registry; see [Configure COM Port and LPT Port Redirection settings using the registry](#).

This setting specifies the bandwidth limit for print jobs using an LPT port in a single client session as a percentage of the total session bandwidth.

By default, no maximum (zero) is specified.

If you enter a value for this setting and a value for the **LPT port redirection bandwidth limit** setting, the most restrictive setting (the lower value) is applied.

If you configure this setting, you must also configure the **Overall session bandwidth limit** setting, which specifies the total amount of bandwidth available for client sessions.

Overall session bandwidth limit

This setting specifies the total amount of bandwidth available, in kilobits per second, for user sessions.

The maximum enforceable bandwidth cap is 20 Mbps (20,000 Kbps). By default, no maximum (zero) is specified.

Limiting the amount of bandwidth consumed by a client connection can improve performance when other applications outside the client connection are competing for limited bandwidth.

Printer redirection bandwidth limit

This setting specifies the maximum allowed bandwidth for accessing client printers in a user session. The maximum allowed bandwidth is specified in kilobits per second.

By default, no maximum (zero) is specified.

If you enter a value for this setting and a value for the **Printer redirection bandwidth limit percent** setting, the most restrictive setting (the lower value) is applied.

Printer redirection bandwidth limit percent

This setting specifies the maximum allowed bandwidth for accessing client printers as a percentage of the total session bandwidth.

By default, no maximum (zero) is specified.

If you enter a value for this setting and a value for the **Printer redirection bandwidth limit** setting, the most restrictive setting (with the lower value) is applied.

If you configure this setting, you must also configure the **Overall session bandwidth limit** setting, which specifies the total amount of bandwidth available for client sessions.

TWAIN device redirection bandwidth limit

This setting specifies the maximum allowed bandwidth for controlling TWAIN imaging devices from published applications. The maximum allowed bandwidth is specified in kilobits per second.

By default, no maximum (zero) is specified.

If you enter a value for this setting and a value for the **TWAIN device redirection bandwidth limit percent** setting, the most restrictive setting (the lower value) is applied.

TWAIN device redirection bandwidth limit percent

This setting specifies the maximum allowed bandwidth for controlling TWAIN imaging devices from published applications as a percentage of the total session bandwidth.

By default, no maximum (zero) is specified.

If you enter a value for this setting and a value for the **TWAIN device redirection bandwidth limit** setting, the most restrictive setting (having the lower value) is applied.

If you configure this setting, you must also configure the **Overall session bandwidth limit** setting, which specifies the total amount of bandwidth available for client sessions.

Bidirectional content redirection policy settings

April 11, 2024

The **Bidirectional Content Redirection** section has policy settings to enable or disable the client-to-VDA and VDA-to-client URL redirection.

Server policies are set in Web Studio. Starting with the Citrix Workspace app version 2311, this setting replaces the following three legacy settings in Web Studio which are deprecated:

- Allow bidirectional content redirection
- Allowed URLs to be redirected to VDA
- Allowed URLs to be redirected to Client

It also replaces the following three local Group Policy Object (GPO) settings on Windows clients:

- Bidirectional content redirection
- Bidirectional content redirection overrides
- OAuth redirection

If this setting is enabled, the client-to-VDA settings are sent to the client upon connecting to a published app or desktop to configure bidirectional content redirection.

Edit Setting
Bidirectional content redirection configuration

Description
Bidirectional content redirection allows URL redirections to occur from VDA-to-client and client-to-VDA. The client-to-VDA configuration is sent to the client upon connecting to a published application or desktop to configure bidirectional content redirection.
An asterisk (*) can be used as a wildcard. For example, *xyz.com will redirect all subdomains of xyz.com.
This settings configuration will take precedence if the policy has legacy settings on the VDA and client.

Applies to the following VDA versions
Server OS: 2311
Desktop OS: 2311
[Show more](#)

Enabled
URLs are redirected from the client to a published application or desktop or from the VDA to the client based on configuration.
1 item configured [Manage URLs](#)

Disabled
URL redirection is prohibited.

[Save](#) [Cancel](#)

If this setting is configured, it takes precedence over the legacy settings in Web Studio and on the client. Citrix recommends using only the new policy settings and deleting any legacy settings to avoid unexpected behavior.

Client policies must not be set if the VDA and DDC are running version 2311 or later. Otherwise, client policies are set from the Citrix Workspace app Group Policy Object administration template.

Citrix offers host-to-client redirection and Local App Access for client-to-URL redirection. However,

Citrix recommends that you use bidirectional content redirection for domain-joined Windows clients.

Citrix recommends using the new UI in Web Studio to configure the feature instead of the Desktop Studio.

Wildcard redirection

Bidirectional content redirection supports the use of wildcards when defining the URLs to be redirected. For more details and to configure bidirectional content redirection, see the [Configuration instructions](#).

In Web Studio, set the wildcard URL by editing the JSON string as a value in the `url` key in the `hostToClientUrls` array or the `clientToHostUrls` array.

Note:

- Don't set the same URL in `hostToClientUrls` and `clientToHostUrls` to avoid infinite loops.
- Top-level domains are not supported. For example, https://www.citrix.* or http://www.citrix.co* is not redirected.

Bidirectional content redirection configuration

Set this policy to [Enabled](#) to start configuring the feature and click **Manage URLs**. Set the following configurations:

- **VDA-to-client redirection**
- **Client-to-VDA redirection**

VDA-to-client redirection

To redirect URLs from VDA to the client, enter one URL per line. Wildcards are allowed. OAuth redirection enables you to use the browser on the client endpoint to perform authentication and send the token back to the VDA.

Benefits:

- You can avoid storing these credentials in the hosted environment.
- You can use biometric capabilities that are available on the endpoint and not on the VDA.

Configurations:

To configure VDA-to-client redirection for the URL, specify the following:

- **URL** (Required) Add the URL that must redirect from the VDA to open on the client. For **OAuth Redirection**, set the authentication scheme and pattern on the client to redirect the session back to the host.
- **Pattern**: (Optional) URL regular expression that, when redirected to the client through VDA-to-Client URL redirection, is tracked as if an OAuth authentication flow has begun, and when the flow completes (detected by the resulting scheme or redirect URL pattern being opened), that resulting URL is redirected back into the host VDA that initiated that flow.
- **Scheme**: (Optional) If **Scheme** is specified, the terminating URL is expected to be of the form: `<scheme>://<something>`. Consider Scheme is not specified (empty). In that case, the original resulting URL pattern is extracted from the Pattern through a regular expression capture group (must be specified in the Pattern), and the original URL is rewritten to use a `citrix-oauth-redir://` redirect URL. When the flow completes, the original redirect URL is then redirected back into the Host (VDA). In this case, any OAuth Authorization server must be configured to allow `citrix-oauth-redir://byIndex/1 (2, 3, ... N)` redirect URLs.

Manage URLs ✕

Bidirectional content redirection

An asterisk (*) can be used as a wildcard. For example, *.xyz.com will redirect all subdomains of xyz.com.

VDA-to-client redirection

Add the URLs that should redirect from the VDA to open on the client. For OAuth redirection, set the authentication scheme and pattern on the client to redirect the session back to the host.

| URL | Pattern | Scheme |
|---|---|--|
| <input type="text" value="Enter URL here"/> | <input type="text" value="Enter pattern here"/> | <input type="text" value="Enter schema here"/> |

+ Add URL

Client-to-VDA redirection

Add a published application or desktop and specify the URLs that should be redirected from the client. If URLs need to be redirected to different locations (override), add another published application or desktop.

+ Add application or desktop

Save
Cancel

Note:

Though both **Pattern** and **Scheme** are optional, if **Pattern** is specified, you must also specify **Scheme**.

Client-to-VDA redirection

To redirect URLs from the client to VDA, complete the following steps:

1. Configure the destination for client URLs.
2. Select either Published Application or Published Desktop.
3. Specify the name of that resource.
4. Add all URLs that must be redirected to that resource.

You can override this default resource by adding a new application or desktop and then specifying the URLs to redirect to that resource.

Manage URLs
×

Bidirectional content redirection

An asterisk (*) can be used as a wildcard. For example, *.xyz.com will redirect all subdomains of xyz.com.

VDA-to-client redirection

Add the URLs that should redirect from the VDA to open on the client. For OAuth redirection, set the authentication scheme and pattern on the client to redirect the session back to the host.

http://www.citrix.com/*
🗑️ ▼

http://www.citrix.net/*
🗑️ ▼

http://www.citrix.org/*
🗑️ ▼

http://www.citrix.ca/*
🗑️ ▼

+ Add URL

Client-to-VDA redirection

Add a published application or desktop and specify the URLs that should be redirected from the client. If URLs need to be redirected to different locations (override), add another published application or desktop.

Type

Select type
▼

Name

Enter name here

URL

Enter URL here

+ Add URL

Save

Cancel

Desktop Studio

Note:

Citrix recommends using Web Studio to configure this feature from Citrix Virtual Apps and Desktops version 2402 onwards.

To configure bidirectional content redirection for 2311, create a JSON string with the following format:

```
1 {
```

```
2
3   "version": 1,
4   "hostToClientConfig": [
5     {
6
7       "hostToClientUrls": [
8         {
9
10          "url": "http://www.citrix.com/*"
11        }
12      ],
13      {
14
15        "url": "www.example.com"
16      }
17    ],
18    {
19
20      "url": "https://login.example.org/*",
21      "oAuthRedirectionPattern": "https://login.example.org/oauth2
22        ?.*",
23      "oAuthScheme": "idm.desktop-authentication"
24    }
25  ]
26 }
27 ],
28 "clientToHostConfig": [
29   {
30
31
32     "publishedAppOrDesktopNameType": "Desktop",
33     "publishedAppOrDesktopName": "Win11Desktop",
34     "clientToHostUrls": [
35       "https://www.example.net",
36       "https://*.citrix.example"
37     ]
38   }
39   ,
40   {
41
42     "publishedAppOrDesktopNameType": "Application",
43     "publishedAppOrDesktopName": "Chrome",
44     "clientToHostUrls": [
45       "https://tibco.example"
46     ]
47   }
48 ]
49 }
50 }
51
52 <!--NeedCopy-->
```

Edit Setting ×

Bidirectional content redirection configuration

connecting to a published application or desktop to configure bidirectional content redirection.

An asterisk (*) can be used as a wildcard. For example, *.xyz.com will redirect all subdomains of xyz.com.

This settings configuration will take precedence if the policy has legacy settings on the VDA and client.

Applies to the following VDA versions

Server OS: 2311, 2402, 2405
Desktop OS: 2311, 2402, 2405

Legacy settings

This setting replaces the following legacy Studio settings, which are no longer supported:

- Allow bidirectional content redirection
- Allowed URLs to be redirected to VDA
- Allowed URLs to be redirected to Client

This setting replaces the following local Group Policy Object settings on Windows clients:

- Bidirectional content redirection
- Bidirectional content redirection overrides
- OAuth Redirection

[Show less](#)

Enabled
URLs are redirected from the client to a published application or desktop or from the VDA to the client based on configuration. Manage URLs
No items configured

Disabled
URL redirection is prohibited.

Save Cancel

The following parameters must be set:

- **version:** (Required) Set to 1.
- For VDA-to-client URL redirection, create a single `hostToClientConfig`.
- **hostToClientUrls:** (Required) List of URLs to be redirected from host (VDA) to client. Wildcards are allowed.

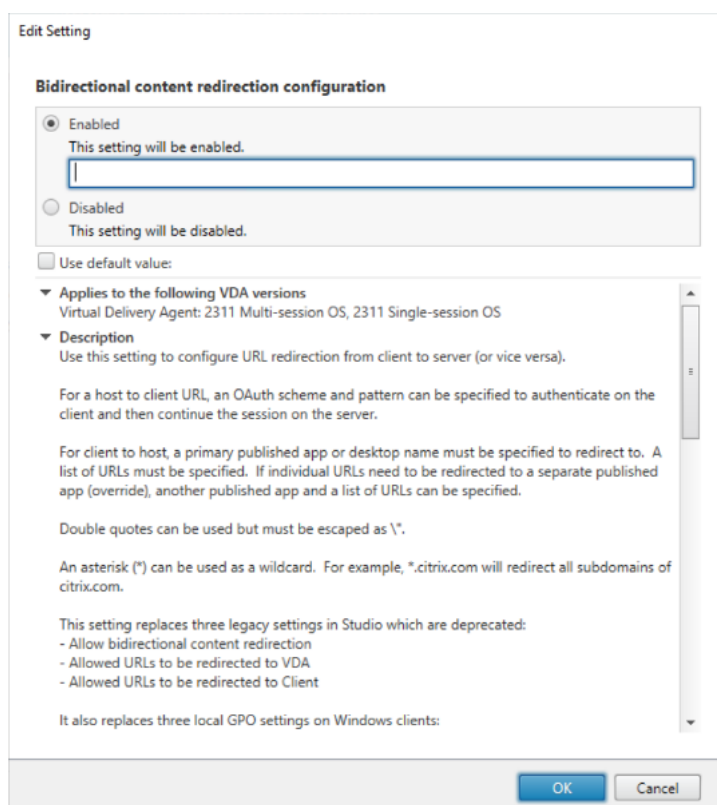

OAuth redirection

OAuth redirection enables you to use the client endpoint browser to authenticate and send the token back to the VDA.

Benefits:

- You can avoid storing these credentials in the hosted environment.
- You can use biometric capabilities that are available on the endpoint and not on the VDA.

To configure OAuth redirection for the URL, specify the following parameters:

- **oAuthRedirectionPattern:** (Optional) URL regular expression that, when redirected to the client via VDA-to-Client URL redirection, is tracked as if an OAuth authentication flow has begun, and when the flow completes (detected by the resulting scheme or redirect URL pattern being opened), that resulting URL is redirected back into the host VDA that initiated that flow.
- **oAuthScheme:** (Optional) If a Scheme is specified, the terminating URL is expected to be in the form: `<scheme>://<something>`. Consider Scheme is not specified (empty). In that case, the original resulting URL pattern is extracted from the Pattern through a regular expression capture group (must be specified in the Pattern), and the original URL is rewritten to use a `citrix-oauth-redir://` redirect URL. When the flow completes, the original redirect URL is then

redirected back into the Host (VDA). In this case, any OAuth Authorization server must be configured to allow `citrix-oauth-redir://byIndex/1 (2, 3, ... N)` redirect URLs.

For a client-to-VDA redirection, create **clientToHostConfig** for each resource to redirect.

For each resource, include the following parameters:

- **publishedAppOrDesktopNameType:** (Required) Either a published desktop (“Desktop”) or a published application (“Application”) configured in Web Studio. If the resource is not valid, redirection does not function correctly.
- **publishedAppOrDesktopName:** (Required) Resource name as configured in Web Studio.
- **clientToHostUrls:** (Required) List of URLs to be redirected from client to host (VDA). Wildcards are allowed.

Known limitation

When you launch a browser using PowerShell with a custom URL scheme (not HTTP or HTTPS), the custom URLs are not redirected to the client.

Browser content redirection policy settings

March 20, 2024

The browser content redirection section includes policy settings to configure this feature.

Browser content redirection controls and optimizes the way Citrix Virtual Apps and Desktops deliver any web browser content (for example, HTML5) to users. Only the visible area of the browser where content is displayed is redirected.

HTML5 video redirection and browser content redirection are independent features. The HTML5 video redirection policies aren’t needed for this feature to work. However, the Citrix HDX HTML5 Video Redirection Service is used for browser content redirection. For more information, see [Browser content redirection](#).

Note:

Policy settings available in Web Studio can be overridden with registry keys on the VDA, but registry keys are optional.

TLS and browser content redirection

You can use browser content redirection to redirect HTTPS websites. The JavaScript injected into those websites must establish a TLS connection to the Citrix HDX HTML5 Video Redirection Service

(WebSocketService.exe) running on the VDA. To achieve this redirection and maintain the TLS integrity of the webpage, the Citrix HDX HTML5 Video Redirection Service generates two custom certificates in the certificate store on the VDA.

HdxVideo.js uses Secure Web sockets to communicate with WebSocketService.exe running on the VDA. This process runs on the Local System, and performs SSL termination and user session mapping.

WebSocketService.exe is listening on 127.0.0.1 port 9001.

Browser content redirection

By default, Citrix Workspace app tries client fetch and client render. The server-side rendering is tried when client fetch and client render fail. If you also enable the browser content redirection proxy configuration policy, Citrix Workspace app tries only server fetch and client render.

By default, this setting is Allowed.

Browser content redirection Integrated Windows Authentication support setting

Browser content redirection enables the overlay that uses the Negotiate scheme for authentication. This enhancement provides single sign-on to a web server configured with Integrated Windows Authentication (IWA) within the same domain as the VDA.

When set to **Allowed**, the browser content redirection overlay obtains a Negotiate ticket by using the user's VDA credentials. The user then authenticates to the web server with a single sign-on.

When set to **Prohibited**, the browser content redirection overlay doesn't request a Negotiate ticket from the VDA. The user authenticates to a web server using a basic authentication method. This authentication method requires users to enter their VDA credentials each time they access the web server.

By default, this setting is Prohibited.

Browser content redirection server fetch web proxy authentication setting

This setting routes HTTP traffic originating at an overlay through a downstream web proxy. The downstream web proxy authorizes and authenticates HTTP traffic using the VDA user's domain credentials through the Negotiate authentication scheme.

You must configure browser content redirection for server fetch mode in the PAC file using the Browser content redirection proxy configuration policy. In the PAC script, provide instructions to route the overlay traffic through a downstream web proxy. Then configure the downstream web proxy to authenticate the VDA users through the Negotiate authentication scheme.

When set to **Allowed**, the web proxy responds with a 407 Negotiate challenge, including a **Proxy-Authenticate: Negotiate** header. Browser content redirection then obtains a Kerberos service ticket by using the VDA user's domain credentials. Also, include the service ticket in later requests to the web proxy.

When set to **Prohibited**, the browser content redirection proxies all TCP traffic between the overlay and the web proxy without interfering. The overlay uses basic authentication credentials or any other available credentials to authenticate to the web proxy.

By default, this setting is Prohibited.

Browser content redirection ACL (Access Control List) Configuration policy settings

Use this setting to configure an Access Control List (ACL) of URLs that can use browser content redirection or are denied access to browser content redirection.

Authorized URLs are the URLs in the allow list whose content is redirected to the client.

The wildcard * is permitted, but it isn't permitted within the protocol or the domain address part of the URL. However, starting from Citrix Virtual Apps and Desktops 7 2206, wildcard * is permitted within the subdomain address part of the URL.

Allowed: <http://www.xyz.com/index.html>, https://www.xyz.com/*, http://www.xyz.com/*videos*, http://*.xyz.com/

Not allowed: http://*.*.com/

You can achieve better granularity by specifying paths in the URL. For example, if you specify <https://www.xyz.com/sports/index.html>, only the index.html page is redirected.

By default, this setting is set to https://www.youtube.com/*

For more information, see the Knowledge Center article [CTX238236](#).

Note:

You can configure ACL to permit BCR to redirect websites to the endpoint and authentication sites can be configured to allow Identity Providers (IdP), such as Okta and Duo, for authentication used on the configured URL.

Browser content redirection authentication sites

Use this setting to configure a list of URLs. Sites redirected by using browser content redirection use the list to authenticate a user. The setting specifies the URLs for which browser content redirection remains active (redirected) when navigating away from a URL in the allow list.

A classic scenario is a website that relies on an Identity Provider (IdP) for authentication. For example, a website www.xyz.com must be redirected to the endpoint, but a third-party IdP, like Okta (www.xyz.okta.com) handles the authentication portion. The administrator uses the browser content redirection ACL configuration policy to add www.xyz.com to the allow list. Then uses browser content redirection authentication sites to add www.xyz.okta.com to the allow list.

For more information, see the Knowledge Center article [CTX238236](#).

Browser content redirection block list setting

This setting works along with the browser content redirection ACL configuration setting. Consider URLs are present in the browser content redirection ACL configuration setting and the block list configuration setting. In this case, the block list configuration takes precedence and the browser content of the URL isn't redirected.

Unauthorized URLs: Specifies the URLs in the block list whose browser content isn't redirected to the client, but rendered on the server.

The wildcard * is permitted, but it isn't permitted within the protocol or the domain address part of the URL.

Allowed: <http://www.xyz.com/index.html>, https://www.xyz.com/*, http://www.xyz.com/*videos*

Not allowed: http://*.xyz.com/

You can achieve better granularity by specifying paths in the URL. For example, if you specify <https://www.xyz.com/sports/index.html>, only index.html is in the block list.

Browser content redirection proxy setting

This setting provides configuration options for proxy settings on the VDA for browser content redirection. If enabled with a valid proxy address and port number, PAC / WPAD URL, or Direct/Transparent setting, Citrix Workspace app tries only server fetch and client rendering.

If disabled or not configured and using a default value, Citrix Workspace app tries client fetch and client rendering.

By default, this setting is Prohibited.

Allowed pattern for an explicit proxy:

<http://\<hostname/ip address\>:\<port\>>

Example:

`http://proxy.example.citrix.com:80`

`http://10.10.10.10:8080`

Allowed patterns for PAC/WPAD files:

`http://<hostname/ip address>:<port>/<path>/<Proxy.pac>`

Example: `http://wpad.myproxy.com:30/configuration/pac/Proxy.pac`

`https://<hostname/ip address>:<port>/<path>/<wpad.dat>`

Example: `http://10.10.10.10/configuration/pac/wpad.dat`

Allowed patterns for direct or transparent proxies:

Type the word **DIRECT** in the policy text box.

Browser content redirection registry key overrides

Warning:

Editing the registry incorrectly can cause serious problems that might require you to reinstall your operating system. Citrix can't guarantee that problems resulting from the incorrect use of the Registry Editor can be solved. Use the Registry Editor at your own risk. Be sure to back up the registry before you edit it.

Registries override options for policy settings:

`\HKEY_LOCAL_MACHINE\SOFTWARE\Citrix\HdxMediastream`

| Name | Type | Value |
|---|--------------|--|
| WebBrowserRedirection | DWORD | 1=Allowed, 0=Prohibited |
| WebBrowserRedirectionAcl | REG_MULTI_SZ | |
| WebBrowserRedirectionAuthenticationSite | REG_MULTI_SZ | |
| WebBrowserRedirectionProxyAddress | REG_SZ | <code>http://myproxy.citrix.com:8080</code> or
<code>http://10.10.10.10:8888</code> |
| WebBrowserRedirectionBlacklist | REG_MULTI_SZ | |

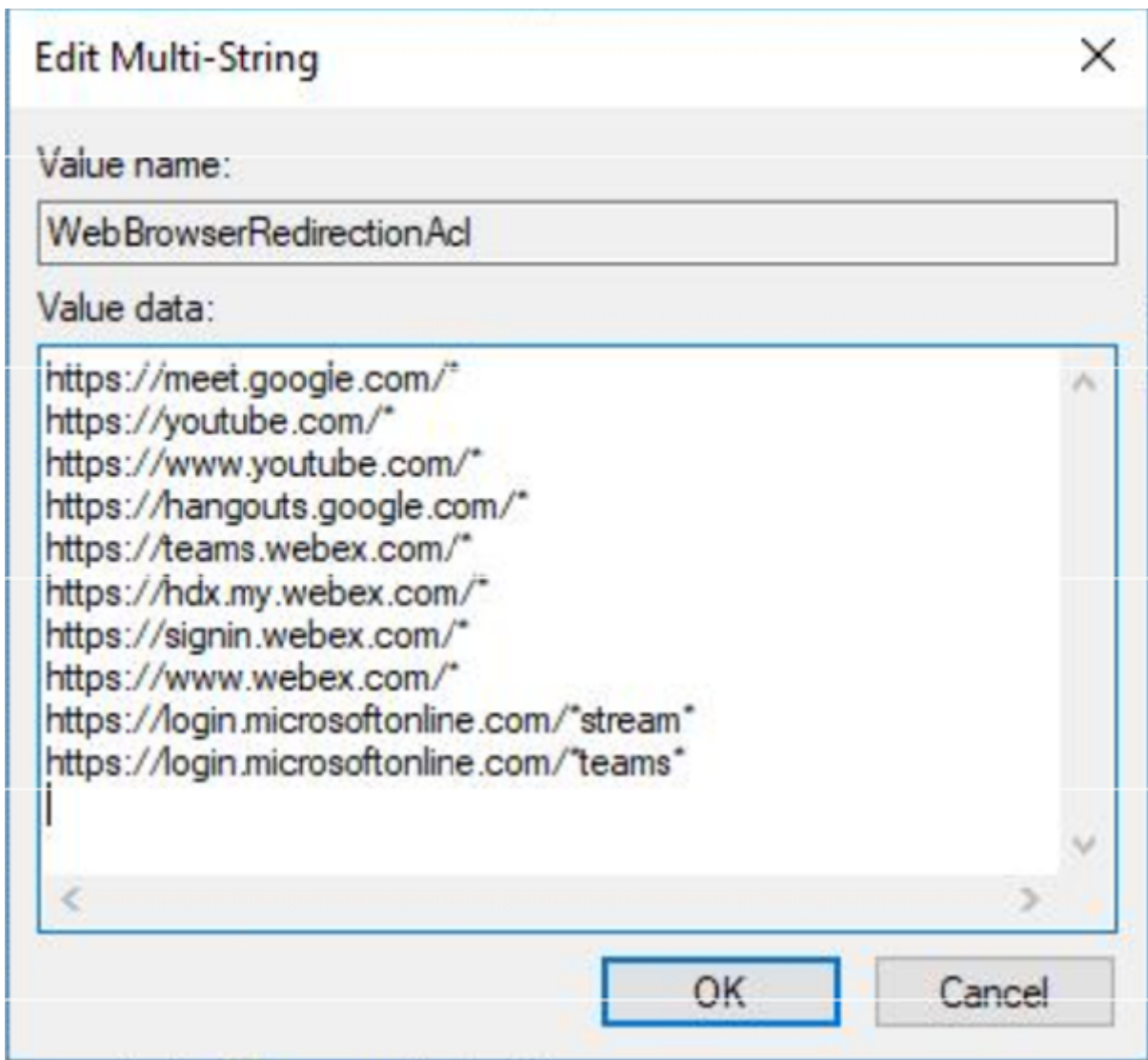

HDXVideo.js insertion for browser content redirection

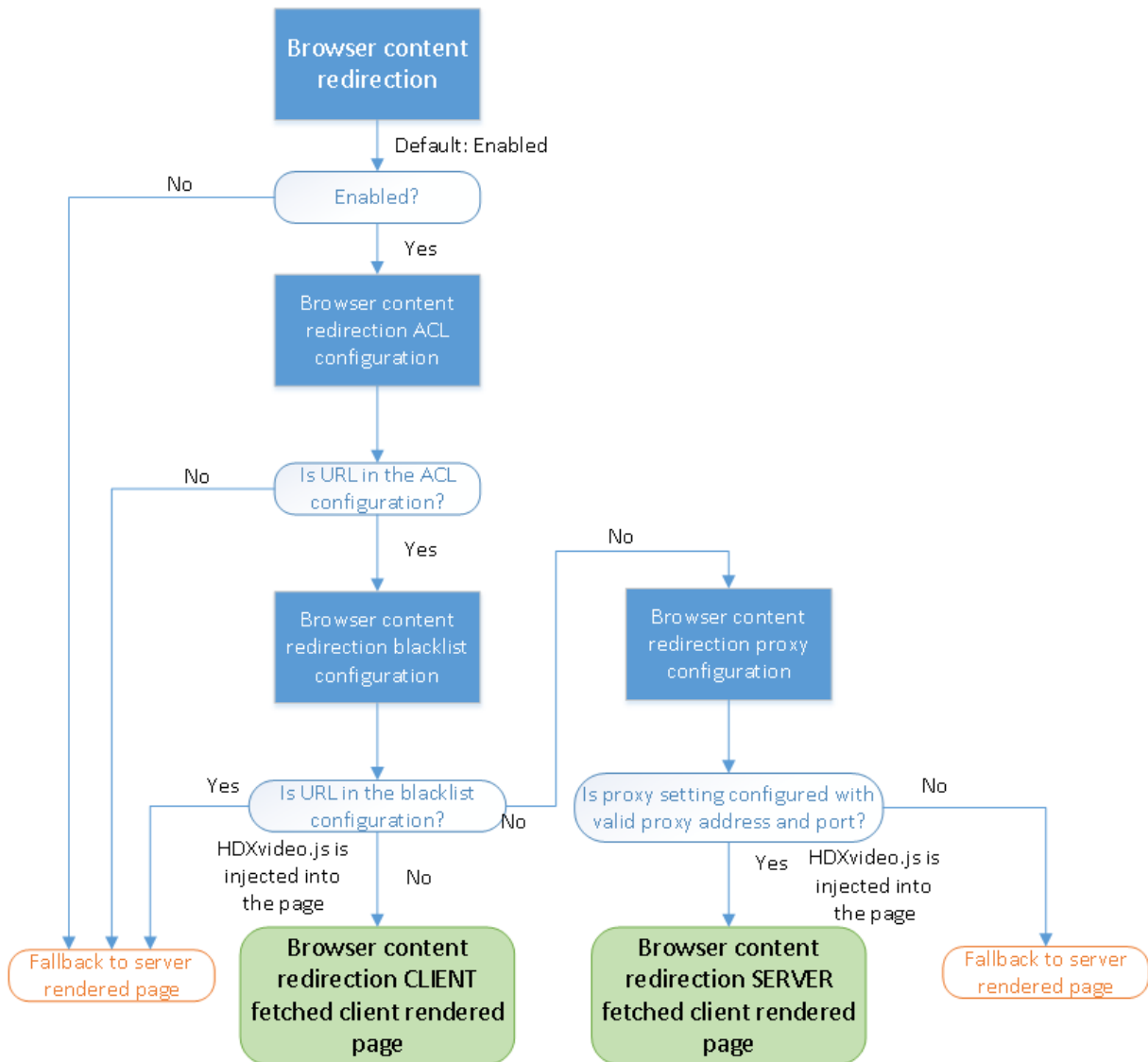

HdxVideo.js is injected on the webpage by using the browser content redirection Chrome extension or the Internet Explorer Browser Helper Object (BHO). The BHO is a plug-in model for Internet Explorer. It provides hooks for browser APIs and allows the plug-in to access the Document Object Model (DOM) of the page to control navigation.

The BHO decides whether to inject HdxVideo.js on a given page. The decision is based on the administrative policies shown in the previous flow chart.

After it decides to inject the JavaScript and redirect browser content to the client, the webpage is blank on the Internet Explorer browser on the VDA. Setting the **document.body.innerHTML** to empty removes the entire body of the webpage on the VDA. The page is ready to be sent to the client to be displayed on the overlay browser (Hdxbrowser.exe) on the client.

Client sensors policy settings

March 7, 2023

The **Client Sensors** section includes policy settings for controlling how mobile device sensor information is handled in a user session.

Allow applications to use the physical location of the client device

This setting determines whether applications running in a session on a mobile device are allowed to use the physical location of the user device.

By default, the use of location information is prohibited

When this setting is prohibited, attempts by an application to retrieve location information return a “permission denied” value.

When this setting is allowed, a user can prohibit use of location information by denying a Citrix Workspace app request to access the location. Android and iOS devices prompt at the first request for location information in each session.

When developing hosted applications that use the Allow applications to use the physical location of the client device setting, consider the following:

- Ensure that a location-enabled application doesn't rely on location information being available because:
 - A user might not allow access to location information.
 - The location might not be available or might change while the application is running.
 - A user might connect to the application session from a different device that does not support location information.
- A location-enabled application must:
 - Have the location feature off by default.
 - Provide the user an option to allow or disallow the feature while the application is running.
 - Provide the user an option to clear location data that the application caches. (Citrix Workspace app does not cache location data.)
- A location-enabled application must manage the granularity of the location information. This management ensures that the data acquired is appropriate to the purpose of the application. Also, conforms to regulations in all relevant jurisdictions.
- Enforce a secure connection (for example, using TLS or a VPN) when using location services. Connect Citrix Workspace app to trusted servers.
- Consider obtaining legal advice regarding the use of location services.

Desktop UI policy settings

May 30, 2022

The **Desktop UI** section includes policy settings that control visual effects such as desktop wallpaper, menu animations, and drag images. These policy settings help to manage the bandwidth used in client connections. You can improve application performance on a WAN by limiting bandwidth usage.

Important:

We do not support legacy graphics mode and Desktop Composition Redirection (DCR) in this release. This policy is included only for backward compatibility when using:

- XenApp 7.15 LTSR
- XenDesktop 7.15 LTSR
- Previous VDA releases with Windows 7 and Windows 2008 R2.

Desktop Composition Redirection

This setting specifies whether to use the processing capabilities of the following for local DirectX graphics rendering to provide users with a more fluid Windows desktop experience:

- Graphics processing unit (GPU) on the user device
- Or,
- Integrated graphics processor (IGP) on the user device

When enabled, **Desktop Composition Redirection** delivers a highly responsive Windows experience while maintaining high scalability on the server.

By default, **Desktop Composition Redirection** is disabled.

To deselect **Desktop Composition Redirection** and reduce the bandwidth required in user sessions, select **Disabled** when you add this setting to a policy.

Desktop Composition Redirection graphics quality

This setting specifies the quality of graphics used for Desktop Composition Redirection.

The default is High.

Choose from High, Medium, Low, or Lossless quality.

Desktop wallpaper

This setting allows or prevents wallpaper showing in user sessions.

By default, user sessions can show wallpaper.

To deselect desktop wallpaper and reduce the bandwidth required in user sessions, select **Prohibited** when adding this setting to a policy.

Menu animation

This setting allows or prevents menu animation in user sessions.

By default, menu animation is allowed.

Menu animation is a Microsoft personal preference setting for ease of access. When enabled, it causes a menu to appear after a short delay, either by scrolling or fading in. An arrow icon appears at the bottom of the menu. The menu appears when you point to that arrow.

Menu animation is enabled on a desktop if this policy setting is set to **Allowed** and the menu animation Microsoft personal preference setting is enabled.

Note:

Changes to the menu animation Microsoft personal preference setting affect the desktop. Consider that you set the desktop to discard changes when the session ends. In this case, a user, who has enabled menu animations, might not have menu animation in subsequent sessions. For users who require menu animation, enable the Microsoft setting in the main image for the desktop or ensure that the desktop retains user changes.

View window contents while dragging

This setting allows or prevents the display of window contents when dragging a window across the screen.

By default, viewing window contents is allowed.

When set to **Allowed**, the entire window appears to move when you drag it. When set to **Prohibited**, only the window outline appears to move until you drop it.

End user monitoring policy settings

May 30, 2022

The **End User Monitoring** section includes policy settings for measuring session traffic.

ICA round trip calculation

This setting determines whether ICA round trip calculations are done for active connections.

By default, calculations for active connections are enabled.

By default, each ICA round trip measurement initiation is delayed. This delay is until some traffic occurs that indicates user interaction. This delay can be indefinite in length and is designed to prevent the ICA round trip measurement being the sole reason for ICA traffic.

ICA round trip calculation interval

This setting specifies the frequency, in seconds, at which ICA round trip calculations are performed.

By default, the ICA round trip is calculated every 15 seconds.

ICA round trip calculations for idle connections

This setting determines whether ICA round trip calculations are done for idle connections.

By default, calculations are not performed for idle connections.

By default, each ICA round trip measurement initiation is delayed. This delay is until some traffic occurs that indicates user interaction. This delay can be indefinite in length and is designed to prevent the ICA round trip measurement being the sole reason for ICA traffic.

Enhanced desktop experience policy setting

May 28, 2022

The Enhanced desktop experience policy setting runs sessions on server-operating systems that look like local Windows 7 desktops.

By default, this setting is allowed.

If a user profile with the Windows Classic theme exists on the virtual desktop, this policy does not provide an enhanced desktop experience for that user. Consider a user with a Windows 7 theme user profile logs on to a virtual desktop running Windows Server 2012. Also, this policy is either not configured or disabled. In this case, that user sees an error message indicating failure to apply the theme.

In both cases, resetting the user profile resolves the issue.

If you disable the policy on a virtual desktop with active user sessions, the interface of those sessions becomes inconsistent on Windows 7 and Windows Classic desktops. To avoid this inconsistency, ensure you restart the virtual desktop after changing this policy setting. Then delete any roaming profiles on the virtual desktop. Citrix also recommends deleting any other user profiles on the virtual desktop to avoid inconsistencies between profiles.

Consider that you are using roaming user profiles in your environment. In this case, ensure that the Enhanced Desktop Experience feature is enabled or disabled for all virtual desktops that share a profile.

Citrix does not recommend sharing roaming profiles between virtual desktops running server operating systems and client operating systems. Profiles for client and server operating systems differ. Sharing roaming profiles across both types can lead to inconsistencies in profile properties when a user moves between the two.

File Redirection policy settings

March 8, 2023

The **File Redirection** section includes policy settings relating to client drive mapping and client drive optimization.

Auto connect client drives

This setting allows or prevents automatic connection of client drives when users log on.

By default, automatic connection is allowed.

When adding this setting to a policy, ensure to enable the settings for the drive types you want automatically connected. For example, to allow automatic connection of users' CD-ROM drives, configure this setting and the **Client optical drives** setting.

The following policy settings are related:

- **Client drive redirection**
- **Client floppy drives**
- **Client optical drives**
- **Client fixed drives**
- **Client network drives**
- **Client removable drives**

Client drive redirection

This setting enables or disables file redirection to and from drives on the user device.

By default, file redirection is enabled.

Note:

Client drive redirection policy settings do not apply to drives mapped to sessions using generic USB redirection.

When enabled, users can save files to all their client drives. When disabled, all file redirection is prevented. This configuration is applicable regardless of the state of the individual file redirection settings. The individual file redirection settings include Client floppy drives and Client network drives.

The following policy settings are related:

- **Client floppy drives**
- **Client optical drives**
- **Client fixed drives**
- **Client network drives**
- **Client removable drives**

Client fixed drives

This setting allows or prevents users from accessing or saving files to fixed drives on the user device.

By default, accessing client-fixed drives is allowed.

When adding this setting to a policy, ensure that the **Client drive redirection** setting is present and set to Allowed. If these settings are disabled, client-fixed drives are not mapped and users cannot access these drives manually, regardless of the state of the **Client fixed drives** setting.

Configure the **Auto connect client drives** setting to ensure that fixed drives are automatically connected when users log on.

Client floppy drives

This setting allows or prevents users from accessing or saving files to floppy drives on the user device.

By default, accessing client-floppy drives is allowed.

When adding this setting to a policy, ensure that the **Client drive redirection** setting is present and set to Allowed. If these settings are disabled, client-floppy drives are not mapped and users cannot access these drives manually, regardless of the state of the **Client floppy drives** setting.

To ensure that floppy drives are automatically connected when users log on, configure the **Auto connect client drives** setting.

Client network drives

This setting allows or prevents users from accessing and saving files to network (remote) drives through the user device.

By default, accessing client network drives is allowed.

When adding this setting to a policy, ensure that the **Client drive redirection** setting is present and set to Allowed. If these settings are disabled, client network drives are not mapped and users cannot access these drives manually. This configuration is applicable regardless of the state of the **Client network drives** setting.

To ensure that network drives are automatically connected when users log on, configure the **Auto connect client drives** setting.

Client optical drives

This setting allows or prevents users from accessing or saving files to the following:

- CD-ROM on the user device
- DVD-ROM on the user device
- BD-ROM drives on the user device.

By default, accessing client-optical drives is allowed.

When adding this setting to a policy, ensure that the **Client drive redirection** setting is present and set to **Allowed**. If these settings are disabled, client-optical drives aren't mapped and users can't access these drives manually. This configuration is applicable regardless of the state of the **Client optical drives** setting.

To ensure that optical drives are automatically connected when users log on, configure the **Auto connect client drives** setting.

Client removable drives

This setting allows or prevents users from accessing or saving files to USB drives on the user device.

By default, accessing client-removable drives is allowed.

When adding this setting to a policy, verify that the **Client drive redirection** setting is present and set to Allowed. If these settings are disabled, client-removable drives are not mapped and users cannot

access these drives manually. This configuration is applicable regardless of the state of the **Client removable drives** setting.

Configure the **Auto connect client drives** setting to ensure that removable drives are automatically connected when users log on.

Host to client redirection

This setting enables or disables file type associations for URLs and some media content to be opened on the user device. When disabled, content opens on the server.

By default, file type association is disabled.

These URL types are opened locally when you enable this setting:

- HTTP
- HTTPS
- Real Player and QuickTime (RTSP)
- Real Player and QuickTime (RTSPU)
- Legacy Real Player (PNM)
- Microsoft Media Server (MMS)

Preserve client drive letters

This setting enables or disables mapping of client drives to the same drive letter in the session.

By default, client drive letters are not preserved.

When adding this setting to a policy, ensure that the **Client drive redirection** setting is present and set to Allowed.

Read-only client drive access

This setting allows or prevents users and applications from the following:

- Creating files on mapped client drives
- Changing files on mapped client drives
- Changing folders on mapped client drives

By default, files and folders on mapped client drives can be changed.

If set to Enabled, files and folders are accessible with read-only permissions.

When adding this setting to a policy, ensure the **Client drive redirection** setting is present and set to Allowed.

Special folder redirection

This setting allows or prevents Citrix Workspace app and Web Interface users to see their local Documents and Desktop special folders from a session.

By default, special folder redirection is allowed.

This setting prevents any objects filtered through a policy from having special folder redirection, regardless of settings that exist elsewhere. When this setting is prohibited, any related settings specified for StoreFront, Web Interface, or Citrix Workspace app are ignored.

To define which users can have special folder redirection, select **Allowed** and include this setting in a policy filtered on the users you want to have this feature. This setting overrides all other special folder redirection settings.

Policy settings that prevent users from accessing or saving files to their local hard drives also prevent special folder redirection from working. This situation occurs because special folder redirection must interact with the user device.

When adding this setting to a policy, ensure that the **Client fixed drives** setting is present and set to Allowed.

File transfer policies

By default, file transfer is enabled. Use Web Studio to change these policies, located under **User setting - ICA\File Redirection**. Consider the following when using file transfer policies:

- **File transfer for Citrix Workspace app for Chrome OS/HTML5** - Allows or prevents users from transferring files between a Citrix Virtual Apps and Desktops session and their devices.
- **Upload file for Citrix Workspace app for Chrome OS/HTML5** - Allows or prevents users from uploading files from their device to a Citrix Virtual Apps and Desktops session.
- **Download file for Citrix Workspace app for Chrome OS/HTML5** - Allows or prevents users from downloading files from a Citrix Virtual Apps and Desktops session to their device.

Note:

The file transfer policies are applicable only for Citrix Workspace app for HTML5 and for Citrix Workspace app for Chrome OS.

Use asynchronous writes

This setting enables or disables asynchronous disk writes.

By default, asynchronous writes are disabled.

Asynchronous disk writes can improve the speed of file transfers and writing to client disks over WANs, which relatively high bandwidth and high latency typically characterize. However, if there is a connection or disk fault, the client file or files being written might end in an undefined state. If this undefined state occurs, a pop-up window informs the user of the files affected. The user can then take remedial action such as restarting an interrupted file transfer on reconnection or when the disk fault is corrected.

Citrix recommends enabling asynchronous disk writes only for users requiring remote connectivity having good file access speed. And who can easily recover files or data lost if there is a connection or disk failure.

When adding this setting to a policy, verify that the **Client drive redirection** setting is present and set to Allowed. If this setting is disabled, asynchronous writes don't occur.

Graphics policy settings

June 20, 2022

The **Graphics** section includes policy settings for controlling how images are handled in user sessions.

Allow visually lossless compression

This setting allows visually lossless compression to be used instead of true lossless compression for graphics. Visually lossless improves performance over true lossless, but has minor loss that is unnoticeable by sight. This setting changes the way the values of the Visual quality setting are used.

By default this setting is disabled.

Graphics status indicator

This setting configures the graphics status indicator to run in the user session. This tool lets the user see information about the active graphics mode. The information includes details about video codec, hardware encoding, image quality, and monitors in use for the session. With the graphics status indicator, the user can also enable or disable pixel-perfect mode.

Releases of Citrix Virtual Apps and Desktops 2103 and later include an image quality slider to help the user find the right balance between image quality and interactivity.

Releases of Citrix Virtual Apps and Desktops 2109 and later include functionality to configure a virtual display layout through a user interface launched using the graphics status indicator.

The graphics status indicator replaces the lossless indicator tool from previous versions. This policy enables the lossless indicator for Citrix Virtual Apps and Desktops versions 7.16 through 1809.

Screen sharing

This setting enables users to share their sessions, including screen contents, keyboards, and mice, with other users.

By default, the setting is disabled.

The VDA attempts to use ports from the TCP port range to exchange data, starting with the lowest port and incrementing on each subsequent connection. The port handles both inbound and outbound traffic.

By default, the TCP port range is set to 52525-52625.

The port used for screen sharing must be added to the firewall exception list. This option is shown as a check box when installing the VDA. By default, this option is not checked.

Display memory limit

This setting specifies the maximum video buffer size in kilobytes for the session.

By default, the display memory limit is 65,536 kilobytes.

Specifies the maximum video buffer size in kilobytes for the session. Specify an amount in kilobytes from 128 to 4,194,303. The maximum value of 4,194,303 does not limit the display memory. By default, the display memory is 65,536 kilobytes. Using more color depth and higher resolution for connections requires more memory. In legacy graphics mode, if the memory limit is reached, the display degrades according to the “Display mode degrade preference” setting.

For connections requiring more color depth and higher resolution, increase the limit. Calculate the maximum memory required using the equation:

Memory depth in bytes = (color-depth-in-bits-per-pixel) / 8) x (vertical-resolution-in-pixels) x (horizontal-resolution-in-pixels).

For example, consider a scenario with a color depth of 32, vertical resolution of 600, and a horizontal resolution of 800. In this case, the maximum memory required is $(32 / 8) \times (600) \times (800) = 1920000$ bytes, which yields a display memory limit of 1920 KB.

Color depths other than 32-bit are available only if the Legacy graphics mode policy setting is enabled.

HDX allocates only the amount of display memory needed for each session. So, if only some users require more than the default, there is no negative impact on scalability by increasing the display memory limit.

Display mode degrade preference

Note:

For the Virtual Delivery Agent 7.x, this policy setting applies only when the Legacy graphics mode policy setting is enabled.

When the session display memory limit is reached, this setting specifies whether color depth or resolution degrades first.

By default, color depth is degraded first.

When the session memory limit is reached, you can reduce the quality of displayed images. You can reduce this quality by choosing whether color depth or resolution is degraded first. When color depth is degraded first, displayed images use fewer colors. When resolution is degraded first, displayed images use fewer pixels per inch.

To notify users when either color depth or resolution is degraded, configure the Notify user when display mode is degraded setting.

Dynamic windows preview

This setting enables or disables the display of seamless windows in:

- Flip-
- Flip 3D
- Taskbar preview
- Windows peek

| Windows Aero preview option | Description |
|-----------------------------|---|
| Taskbar Preview | When the user hovers over a window's taskbar icon, an image of that window appears above the taskbar. |
| Windows Peek | When the user hovers over a taskbar preview image, a full-sized image of the window appears on the screen. |
| Flip | When the user presses ALT+TAB, small preview icons are shown for each open window. |
| Flip 3D | When the user presses the TAB+Windows logo key, large images of the open windows cascade across the screen. |

By default, this setting is enabled.

Image caching

Note:

For the Virtual Delivery Agent 7.x, this policy setting applies only when the Legacy graphics mode policy setting is enabled.

This setting enables or disables the caching and retrieving of sections of images in sessions. Caching images in sections and retrieving these sections when needed makes the following:

- Scrolling smoother on the user device
- Reduces the amount of data transmitted over the network on the user device
- Reduces the processing required on the user device

By default, the image caching setting is enabled.

Note:

The image caching setting controls how images are cached and retrieved. The setting does not control whether images are cached. Images are cached if the Legacy graphics mode setting is enabled.

Legacy graphics mode - not supported. For backward compatibility only

Important:

We do not support legacy graphics mode and Desktop Composition Redirection (DCR) in this release. This policy is included only for backward compatibility when using XenApp 7.15 LTSR, XenDesktop 7.15 LTSR, and previous VDA releases with Windows 7 and Windows 2008 R2.

This setting disables the rich graphics experience. Use this setting to revert to the legacy graphics experience, reducing bandwidth consumption over a WAN or mobile connection. Bandwidth reductions introduced in XenApp and XenDesktop 7.13 make this mode obsolete.

By default, this setting is disabled and users are provided with the rich graphics experience.

Legacy graphics mode is supported on the following:

- Windows 7
- Windows Server 2008 R2 VDAs.

Legacy graphics mode is not supported on the following:

- Windows 8.x and 10
- Windows Server 2012, 2012 R2, and 2016.

See [CTX202687](#) for more on optimizing graphics modes and policies in XenApp and XenDesktop 7.6 FP3 or higher.

Maximum allowed color depth

Note:

For the Virtual Delivery Agent 7.x, this policy setting applies only when the Legacy graphics mode policy setting is enabled.

This setting specifies the maximum color depth allowed for a session.

By default, the maximum allowed color depth is 32 bits per pixel.

This setting applies only to Thinwire drivers and connections. It does not apply to VDAs that have a non-ThinWire driver as the primary display driver. These VDAs are VDAs that use a Windows Display Driver Model (WDDM) driver as the primary display driver. For Single-session OS VDAs using a WDDM driver as the primary display driver, such as Windows 8, this setting has no effect. For Windows Multi-session OS VDAs using a WDDM driver, such as Windows Server 2012 R2, this setting might prevent users from connecting to the VDA.

Setting a high color depth requires more memory. To degrade color depth when the memory limit is reached, configure the **Display mode degrade preference** setting. When color depth is degraded, displayed images use fewer colors.

Notify user when display mode is degraded

Note:

For the Virtual Delivery Agent 7.x, this policy setting applies only when the Legacy graphics mode policy setting is enabled.

This setting displays a brief explanation to the user when the color depth or resolution is degraded.

By default, notifying users is disabled.

Optimize for 3D graphics workload

This setting configures the appropriate default settings that best suit graphically intense workloads. Enable this setting for users whose workload focuses on graphically intense applications. Apply this policy only in cases where a GPU is available to the session. Any other settings that explicitly override the default settings set by this policy take precedence.

By default, optimize for the 3D graphics workload is disabled.

Queuing and tossing

Note:

For the Virtual Delivery Agent 7.x, this policy setting applies only when the Legacy graphics mode policy setting is enabled.

This setting discards queued images that another image replaces.

By default, queuing and tossing is enabled.

This setting improves response when graphics are sent to the user device. Configuring this setting can cause animations to become choppy because of dropped frames.

Use video codec for compression

Allows use of a video codec to compress graphics when video decoding is available on the endpoint. When **For the entire screen** is chosen the video codec is applied as the default codec for all. When **For actively changing regions** is selected the video codec is used for areas where there is constant change on the screen, other data uses still image compression and bitmap caching. When video decoding is not available on the endpoint, or when you specify **Do not use video codec**, a combination of still image compression and bitmap caching is used. When **Use when preferred** is selected, the system chooses, based on various factors. The results might vary between versions as the selection method is enhanced.

Select **Use when preferred** to allow the system to make its best effort to choose appropriate settings for the current scenario.

Select **For the entire screen** to optimize for improved user experience and bandwidth, especially in cases with heavy use of server-rendered video and 3D graphics.

Select **For actively changing regions** to optimize for improved video performance, especially in low bandwidth, while maintaining scalability for static and slowly changing content. This setting is supported in multi-monitor deployments.

Select **Do not use video codec** to optimize for server CPU load and for cases that do not have numerous server-rendered videos or other graphically intense applications.

The default is **Use when preferred**.

Use hardware encoding for video

This setting allows the use of graphics hardware, if available, to compress screen elements with the video codec. If such hardware is not available, the VDA falls back to CPU-based encoding using the software video codec.

The default option for this policy setting is **Enabled**.

Multiple monitors are supported.

Any Citrix Workspace app that supports video decoding can be used with hardware encoding.

NVIDIA

For NVIDIA GRID GPUs, hardware encoding is supported with VDAs for Multi-session OS and Single-session OS.

NVIDIA GPUs must support NVENC hardware encoding. See [NVIDIA video codec SDK](#) for a list of supported GPUs.

NVIDIA GRID requires driver version 3.1 or higher. NVIDIA Quadro requires driver version 362.56 or higher. Citrix recommends drivers from the NVIDIA Release R361 branch.

Lossless text is not compatible with NVENC hardware encoding. If you enabled lossless text, lossless text takes priority over NVENC hardware encoding.

Selective use of the H.264 hardware codec for actively changing regions is supported.

Visually lossless (YUV 4:4:4) compression is supported. Visually lossless (graphics policy setting, [Allow visually lossless compression](#)) requires Citrix Workspace app 1808 or higher or Citrix Receiver for Windows 4.5 or higher.

Intel

For Intel Iris Pro graphics processors, hardware encoding is supported with VDAs for Single-session OS and Multi-session OS.

Intel Iris Pro graphics processors in the [Intel Broadwell processor family](#) and later are supported. Intel Remote Displays SDK version 1.0 is required and can be downloaded from the Intel website: [Remote Displays SDK](#).

Lossless text is supported only when the Video codec policy is set for the entire screen and the **Optimize for 3D graphics workload** policy is disabled.

Visually lossless (YUV 4:4:4) is not supported.

The Intel encoder provides a good user experience for up to eight encoding sessions (for example one user using eight monitors or eight users using a monitor each). If more than eight encoding sessions are required, check how many monitors the virtual machine connects with. The administrator decides to configure this policy setting on a per user or per machine basis to maintain a good user experience.

AMD

For AMD, hardware encoding is supported with VDAs for a Single-session OS.

AMD GPUs must support the RapidFire SDK. For example, the AMD Radeon Pro or FirePro GPUs.

For encoding to work, install the latest AMD drivers. You can download those drivers from <https://www.amd.com/en/support>.

Lossless text isn't compatible with AMD hardware encoding. If you enabled lossless text, lossless text takes priority over AMD hardware encoding.

Selective use of the H.264 hardware codec for actively changing regions is supported.

Caching policy settings

May 30, 2022

This section includes policy settings that enable caching image data on user devices when client connections are limited in bandwidth.

Persistent cache threshold

Note: For the Virtual Delivery Agent 7.x, this policy setting applies only when the **Legacy graphics mode** policy setting is enabled.

This setting caches bitmaps on the hard drive of the user device and thus enables reuse of large, frequently used images from previous sessions.

By default, the threshold is 3000000 bits per second.

The threshold value represents the point below which the Persistent Cache feature takes effect. For example, using the default value, bitmaps are cached on the hard drive of the user device when bandwidth falls below 3000000 bps.

Framehawk policy settings

May 30, 2022

Important:

As of Citrix Virtual Apps and Desktops 7 1903, Framehawk is no longer supported. Instead, use [Thinwire](#) with [adaptive transport](#) enabled.

The **Framehawk** section includes policy settings that enable and configure the Framehawk display channel on the server.

Framehawk display channel

When enabled, the server attempts to use the Framehawk display channel for the user's graphics and input remoting. That display channel uses UDP to provide a better user experience on networks with high loss and latency characteristics. However, it can also use more server resources and bandwidth than other graphics modes.

By default, the Framehawk display channel is disabled.

Framehawk display channel port range

This policy setting specifies the range of UDP port numbers that the VDA uses to exchange Framehawk display channel data with the user device. The port numbers are in the form *lowest port number or highest port number*. The VDA attempts to use each port, starting with the lowest port number and incrementing for each subsequent attempt. The port handles inbound and outbound traffic.

By default, the port range is 3224,3324.

Keep alive policy settings

May 30, 2022

The **Keep Alive** section contains policy settings for managing ICA keep-alive messages.

ICA keep-alive timeout

This setting specifies the number of seconds between successive ICA keep-alive messages.

By default, the interval between keep-alive messages is 60 seconds.

Specify an interval between 1-3600 seconds in which to send ICA keep-alive messages. Do not configure this setting if your network monitoring software is responsible for closing inactive connections.

ICA keep-alive messages

This setting enables or disables sending ICA keep-alive messages periodically.

By default, keep-alive messages are not sent.

Enabling this setting prevents broken connections from being disconnected. If the server detects no activity, this setting prevents Remote Desktop Services (RDS) from disconnecting the session. The server sends keep-alive messages every few seconds to detect if the session is active. If the session is no longer active, the server marks the session as disconnected.

ICA keep-alive does not work if you are using session reliability. Configure ICA keep-alive only for connections that are not using Session Reliability.

Related policy settings: Session reliability connections.

Local App Access policy settings

March 8, 2023

The **Local App Access** section includes policy settings that manage the users' locally installed applications with hosted applications. These policy settings manage integration in a hosted desktop environment.

Allow Local App Access

This setting allows or prevents the integration of users' locally installed applications with hosted applications. These policy settings manage integration in a hosted desktop environment.

When a user starts a locally installed application, that application appears to run within their virtual desktop, even though it's actually running locally.

If you set the **Allow local app access** policy setting to **Enabled**, browser content redirection isn't supported and the client-side notification area battery status does not appear in desktop sessions.

By default, **Allow Local App Access** is prohibited.

URL redirection block list

This setting specifies websites that are redirected to and started in the local Web browser. These websites might include the following:

- Websites requiring locale information, such as msn.com or newsgoogle.com

- Websites containing rich media content that are better rendered on the user device.

By default, no sites are specified.

URL redirection allow list

This setting specifies websites that are rendered in the environment in which they're started.

By default, no sites are specified.

Mobile experience policy settings

May 30, 2022

The **Mobile Experience** section includes policy settings for handling the Citrix Mobility Pack.

Automatic keyboard display

This setting enables or disables the automatic display of the keyboard on mobile device screens.

By default, the automatic display of the keyboard is disabled.

Launch touch-optimized desktop

This setting is disabled and not available for Windows 10 or Windows Server 2016 machines.

This setting determines the overall Citrix Workspace app interface behavior. This setting allows or prohibits a touch-friendly interface that is optimized for tablet devices.

By default, a touch-friendly interface is used.

To use only the Windows interface, set this policy setting to Prohibited.

Remote the combo box

This setting determines the types of combo boxes that you can display in sessions on mobile devices. Set this policy setting to Allowed to display the device-native combo box control. When this setting is allowed, a user can change a Citrix Workspace app for iOS session setting to use the Windows combo box.

By default, the **Remote the combo box** feature is prohibited.

Multimedia policy settings

December 12, 2023

The **Multimedia** section includes policy settings for managing streaming HTML5 and Windows audio and video in user sessions.

Warning

Editing the registry incorrectly can cause serious problems that might require you to reinstall your operating system. Citrix can't guarantee that problems resulting from the incorrect use of the Registry Editor can be solved. Use the Registry Editor at your own risk. Be sure to back up the registry before you edit it.

Multimedia policies

By default, all multimedia policies set on the Delivery Controller are stored in these registries:

Machine policies:

HKEY_LOCAL_MACHINE\Software\Policies\Citrix\MultimediaPolicies

User policies:

HKEY_LOCAL_MACHINE\Software\Policies\Citrix{User Session ID}\User\MultimediaPolicies

To locate the current user session ID, issue the **qwinsta** command on the Windows command line.

HTML5 video redirection

Controls and optimizes the way Citrix Virtual Apps and Desktops servers deliver HTML5 multimedia web content to users.

By default, this setting is disabled.

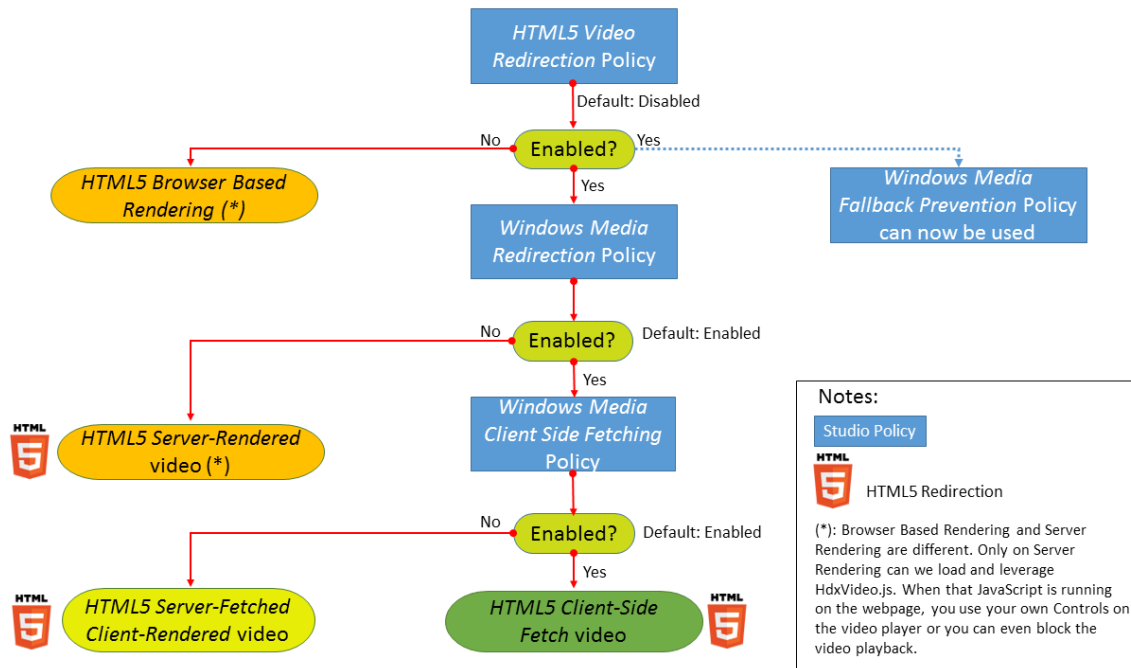

In this release, this feature is available for controlled webpages only. It requires the addition of JavaScript to the webpages where the HTML5 multimedia content is available, for example, videos on an internal training site.

To configure HTML5 video redirection:

1. Copy the file, **HdxVideo.js**, from %Program Files%/Citrix/ICA Service/HTML5 Video Redirection on the VDA install to the location of your internal webpage.
2. Insert this line into your webpage (if your webpage has other scripts, include **HdxVideo.js** before those scripts):

```
<script src="HdxVideo.js" type="text/javascript"></script>
```

Note: If HdxVideo.js isn't in the same location as your webpage, use the **src** attribute to specify the full path to it.

Consider that the JavaScript isn't added to your controlled webpages and the user plays an HTML5 video. In this case, Citrix Virtual Apps and Desktops default to server side rendering.

For redirection of HTML5 videos to work, allow **Windows Media Redirection**. This policy is mandatory for Server Fetch Client Render, and necessary for Client Side Fetching. Client Side Fetching in turn also requires *Windows Media client-side content fetching* to be Allowed.

Microsoft Edge doesn't support this feature.

HdxVideo.js replaces the browser HTML5 Player controls with its own. To check that the HTML5 video redirection policy is in effect on a certain website, compare the player controls to a scenario where the **HTML5 video redirection** policy is Prohibited:

(Citrix custom controls when the policy is Allowed)



(Native webpage controls when the policy is Prohibited or not configured)



The following video controls are supported:

- play
- pause
- seek
- repeat
- audio
- full screen

You can view an HTML5 video redirection test page at <https://www.citrix.com/virtualization/hdx/html5-redirect.html>.

TLS, HTML5 video redirection, and browser content redirection

You can use HTML5 video redirection to:

- Redirect videos from HTTPS websites
- Or
- Browser content redirection to redirect the entire website

The JavaScript injected into those websites must establish a TLS connection to the Citrix HDX HTML5 Video Redirection Service (WebSocketService.exe) running on the VDA. Citrix HDX HTML5 Video Redirection Service in the certificate store on the VDA generates two custom certificates to:

- Achieve video redirection
- Maintain the TLS integrity of the webpage

HdxVideo.js uses Secure WebSockets to communicate with WebSocketService.exe running on the VDA. This process runs as a Local System account, and does SSL termination and user session mapping.

WebSocketService.exe is listening on 127.0.0.1 port 9001.

Limit video quality

This setting applies only to Windows Media and not to HTML5. It requires you enable **Optimization for Windows Media multimedia redirection over WAN**.

This setting specifies the maximum video quality level allowed for an HDX connection. When configured, maximum video quality is limited to the specified value, ensuring that multimedia Quality of Service (QoS) is maintained within an environment.

By default, this setting isn't configured.

To limit the maximum video quality level allowed, choose one of the following options:

- 1080p/8.5mbps
- 720p/4.0mbps
- 480p/720kbps
- 380p/400kbps
- 240p/200kbps

Playing multiple videos simultaneously on the same server consumes large amounts of resources and can impact server scalability.

Microsoft Teams redirection

This setting enables optimization of Microsoft Teams, based on the HDX technology.

If this policy is enabled, and you're using a supported version of Citrix Workspace app, this registry key is set to **1** on the VDA. The Microsoft Teams application reads the key to load in VDI mode.

Note it is not required to set the registry key manually.

HKEY_CURRENT_USER\Software\Citrix\HDXMediaStream

Name: MSTeamsRedirSupport

Value: DWORD (1 - on, 0 - off)

Note:

Consider that you're using version 1906.2 VDAs or later with older versions of the Controller, which do not have the policy available in Web Studio. An example for an older version of the controller is version 7.15. In this case, HDX optimization is enabled by default on the VDA. If the Workspace app version is 1907 or later, Microsoft Teams launches in optimized mode. For information about caveats in mixing 7.15 LTSR Controllers and CR VDAs, see Knowledge Center article [CTX205549](#).

In this case, to disable the feature for specific users, you can override the registry setting. Override the registry settings by using a group policy to apply a logon script to the user's organizational unit.

By default, Microsoft Teams redirection is enabled.

Multimedia conferencing

This setting allows or prevents the use of optimized webcam redirection technology by video conferencing applications.

By default, video conferencing support is allowed.

When adding this setting to a policy, verify that the **Windows Media redirection** setting is present and set to **Allowed** (the default).

When using **Multimedia conferencing**, verify that the following conditions are met:

- Manufacturer-supplied drivers for the webcam used for multimedia conferencing are installed on the client.
- Connect the webcam to the user device before starting a video conferencing session. The server uses only one installed webcam at any given time. If multiple webcams are installed on the user device, the server attempts to use each webcam in succession. This attempt continues until a video conferencing session is created successfully.

This policy isn't needed when redirecting the web cam using Generic USB redirection. In that case, install the webcam drivers on the VDA.

Optimization for Windows Media multimedia redirection over WAN

This setting applies only to Windows Media and not to HTML5. The setting enables the following:

- Real-time multimedia transcoding
- Allows audio and video media streaming to mobile devices over degraded networks
- Enhances the user experience by improving how Windows Media content is delivered over a WAN.

By default, the delivery of Windows Media content over the WAN is optimized.

When adding this setting to a policy, make sure the **Windows Media Redirection** setting is present and set to **Allowed**.

When this setting is enabled, real-time multimedia transcoding is deployed automatically as needed to enable media streaming. Also, provide a seamless user experience even in extreme network conditions.

Use GPU for optimizing Windows Media multimedia redirection over WAN

This setting applies only to Windows Media and enables real-time multimedia transcoding to be done in the Graphics Processing Unit (GPU) on the Virtual Delivery Agent (VDA). It improves server scala-

bility. GPU transcoding is available only if the VDA has a supported GPU for hardware acceleration. Otherwise, transcoding falls back to the CPU.

Note: GPU transcoding is supported only on NVIDIA GPUs.

By default, using the GPU on the VDA to optimize the delivery of Windows Media content over the WAN is prohibited.

When adding this setting to a policy, make sure that the following settings are present and set to Allowed:

- **Windows Media redirection**
- **Optimization for Windows Media multimedia redirection over WAN settings**

Windows Media fallback prevention

This setting applies to browser content redirection, HTML5, and Windows Media. For it to support HTML5, set the **HTML5 video redirection** policy to **Allowed**.

Administrators can use the **Windows Media fallback prevention** policy setting to specify the methods that is attempted to deliver streamed content to users.

By default, this setting isn't configured. When the setting is set to Not Configured, the behavior is the same as **Play all content**.

To configure this setting, choose one of the following options:

- **Play all content.** Attempt client-side content fetching, then Windows Media Redirection. If unsuccessful, play content on the server.
- **Play all content only on client.** Attempt client-side fetching, then Windows Media Redirection. If unsuccessful, the content does not play.
- **Play only client-accessible content on client.** Attempt only client-side fetching. If unsuccessful, the content does not play.

When the content does not play, the following error message displays in the player window (for a default duration of 5 seconds):

```
1 "Company has blocked video because of lack of resources"
```

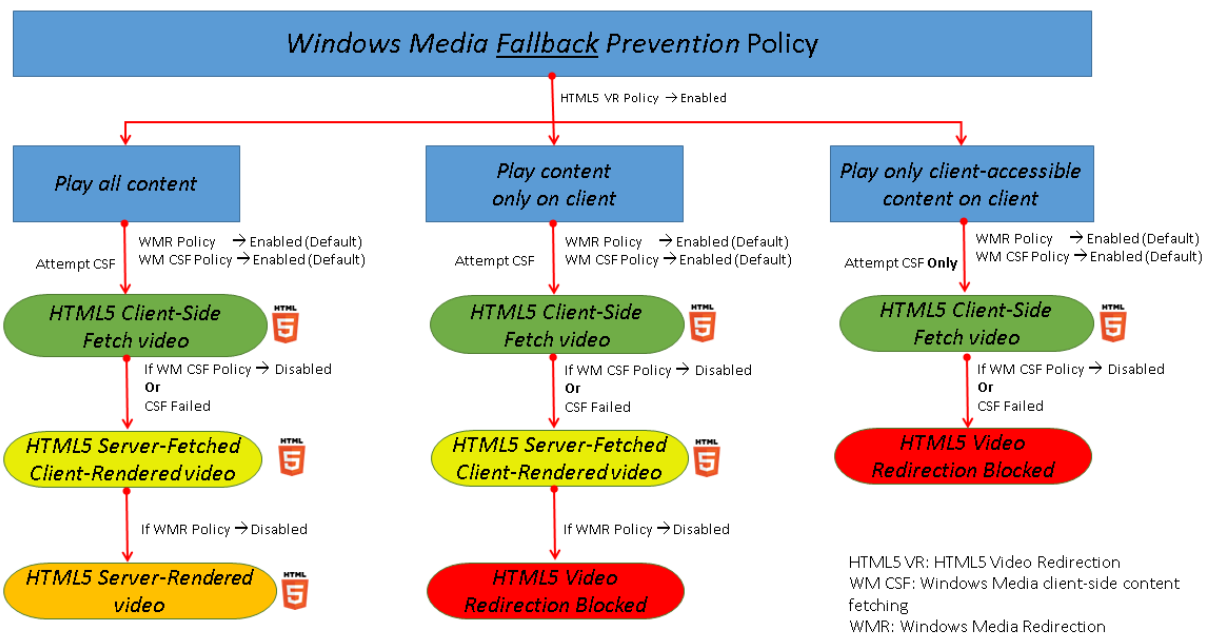

The duration of this error message can be customized with the following registry key on the VDA. If the registry entry does not exist, the duration defaults to 5 seconds.

The registry path varies depending on the architecture of the VDA:

\HKLM\SOFTWARE\Wow6432Node\Citrix\HdxMediastream

Or

\HKLM\SOFTWARE\Citrix\HdxMediastream

Registry key:

Name: VideoLoadManagementErrDuration

Type: DWORD

Range: 1 - up to DWORD limit (default = 5)

Unit: seconds

Windows Media client-side content fetching

This setting applies to both HTML5 and Windows Media. The setting enables a user device to stream multimedia files directly from the source provider on the internet or intranet, rather than through the XenApp or XenDesktop host server.

By default, this setting is **Allowed**. Allowing this setting improves network usage and server scalability. This improvement is achieved by moving any processing on the media from the host server to the user device. It also removes the requirement that an advanced multimedia framework such as Microsoft

DirectShow or Media Foundation be installed on the user device. The user device requires only the ability to play a file from a URL

When adding this setting to a policy, make sure the **Windows Media Redirection** setting is present and set to **Allowed**. If **Windows Media Redirection** is disabled, the streaming of multimedia files to the user device direct from the source provider is also disabled.

Windows Media redirection

This setting applies to both HTML5 and Windows Media and controls and optimizes the way servers deliver streaming audio and video to users.

By default, this setting is **Allowed**. For HTML5, this setting doesn't take effect if the policy **HTML5 video redirection** is **Prohibited**.

When this setting is enabled the quality of audio and video rendered from the server increases to a level that compares with audio and video that played locally on a user device. The server streams multimedia to the client in the original, compressed form and allows the user device to decompress and render the media.

Windows Media redirection optimizes multimedia files that are encoded with codecs that adhere to Microsoft DirectShow, DirectX Media Objects (DMO), and Media Foundation standards. To play back a given multimedia file, a codec compatible with the encoding format of the multimedia file must be present on the user device.

By default, audio is disabled on Citrix Workspace app. To allow users to run multimedia applications in ICA sessions, turn on audio or give users permission to turn on audio in their Citrix Workspace app interface.

Select **Prohibited** only if playing media using Windows Media redirection appears worse than when rendered using basic ICA compression and regular audio. This situation is rare but can happen under low bandwidth conditions, for example, with media with a low frequency of key frames.

Windows Media Redirection buffer size

This setting is a legacy and does not apply to HTML5.

This setting specifies a buffer size from 1 to 10 seconds for multimedia acceleration.

By default, the buffer size is 5 seconds.

Windows Media Redirection buffer size use

This setting is a legacy and does not apply to HTML5.

This setting enables or disables using the buffer size specified in the **Windows Media Redirection buffer size** setting.

By default, the buffer size specified isn't used.

If this setting is disabled or if the **Windows Media Redirection buffer size** setting is not configured, the server uses the default buffer size value (five seconds).

Multi-stream connections policy settings

October 11, 2022

The **Multi-Stream connections** section includes policy settings for managing Quality of Service prioritization for multiple ICA connections in a session.

Note:

MTU Discovery is not supported if the Multi-Stream connections policy is enabled.

Audio over UDP

This setting allows or prevents audio over UDP on the server.

By default, audio over UDP is allowed on the server.

When enabled, this setting opens a UDP port on the server to support all connections configured to use Audio over UDP Real-time Transport.

Audio UDP port range

This setting specifies the range of port numbers (lowest port number, highest port number) used by the Virtual Delivery Agent (VDA). This specification helps to exchange audio packet data with the user device. The VDA attempts to use each UDP port pair to exchange data with the user device, starting with the lowest and incrementing by two for each subsequent attempt. Each port handles both inbound and outbound traffic.

By default, this range is set to 16500,16509.

Multi-Port policy

This setting specifies the TCP ports to be used for ICA traffic and establishes the network priority for each port.

By default, the primary port (2598) has a High priority.

When you configure ports, you can assign the following priorities:

- **Very High:** for real-time activities, such as webcam conferences
- **High:** for interactive elements, such as screen, keyboard, and mouse
- **Medium:** for bulk processes, such as client drive mapping
- **Low:** for background activities, such as printing

Each port must have a unique priority. For example, you cannot assign a Very High priority to both CGP port 1 and CGP port 3.

To remove a port from prioritization, set the port number to 0. You cannot remove the primary port and you cannot change its priority level.

When configuring this setting, restart the server. This setting takes effect only when the **Multi-Stream computer** setting policy setting is enabled.

Multi-Stream computer setting

This setting enables or disables Multi-Stream on the server.

By default, Multi-Stream is disabled. Configure the Multi-Stream computer policy setting if you use Citrix SD-WAN or third-party routers to achieve the desired Quality of Service.

If Multi-Stream is enabled, MTU Discovery, a feature of Adaptive Transport, is not supported.

When configuring this setting, reboot the server to ensure that changes take effect.

Important:

Using this policy setting with bandwidth limit policy settings such as Overall session bandwidth limit might produce unexpected results. When including this setting in a policy, ensure that bandwidth limit settings are not included.

Multi-Stream user setting

This setting enables or disables Multi-Stream on the user device.

By default, Multi-Stream is disabled for all users. Configure the Multi-Stream user setting if you use Citrix SD-WAN or third-party routers to achieve the desired Quality of Service.

This setting takes effect only on hosts where the **Multi-Stream computer** setting policy setting is enabled.

Important:

Using this policy setting with bandwidth limit policy settings such as Overall session bandwidth limit might produce unexpected results. When including this setting in a policy, ensure that bandwidth limit settings are not included.

Multi-Stream virtual channel assignment settings

This setting specifies the ICA stream the virtual channels are assigned to when multi-stream is used.

If you do not configure these settings, virtual channels are kept in their default stream. To assign a virtual channel to an ICA stream, select the desired stream number (0, 1, 2, 3) from the **Stream Number** list next to the virtual channel name.

If there is a custom virtual channel in use in the environment, click **Add**, specify the virtual channel name in the text box under **Virtual Channels**, and select the desired stream number from the **Stream Number** list next to it. The name you specify must be the actual virtual channel name and not a friendly name. For example, CTXSBR instead of Citrix Browser Acceleration.

These settings take effect only when you've enabled the multi-stream computer setting.

By default, the virtual channels and their stream assignments are:

- AppFlow: 2
- Audio: 0
- Browser Content Redirection: 2
- Client COM Port Mapping: 3
- Client Drive Mapping: 2
- Client Printer Mapping: 3
- Clipboard: 2
- CTXDND: 1 (**Note:** This supports the dragging and dropping files between a Citrix session and a local endpoint.)
- DVC Plug-in (Static VC name auto-generated from DVC Plug-in Friendly Name, or admin-assigned): 2
- End User Experience Monitoring: 1
- File Transfer (HTML5 Receiver): 2
- Generic Data Transfer: 2
- ICA Control: 1
- Input Method Editor: 1
- Legacy Client Printer Mapping (COM1): 1, 3
- Legacy Client Printer Mapping (COM2): 2, 3
- Legacy Client Printer Mapping (LPT1): 1, 3
- Legacy Client Printer Mapping (LPT2): 2, 3

- License Management: 1
- Microsoft Teams/WebRTC Redirection: 1
- Mobile Receiver: 1
- MultiTouch: 1
- Port Forwarding: 2
- Remote Audio and Video Extensions (RAVE): 2
- Seamless (Transparent Window Integration): 1
- Sensor and Location: 1
- Smart Card: 1
- Thinwire Graphics: 1
- Transparent UI Integration/Logon Status: 2
- TWAIN Redirection: 2
- USB: 2
- Zero Latency Font and Keyboard: 2
- Zero Latency Data Channel: 2

For more information on virtual channel assignments and priorities, see the Knowledge Center article [CTX131001](#).

Port redirection policy settings

May 30, 2022

The **Port Redirection** section contains policy settings for client LPT and COM port mapping.

For Virtual Delivery Agent versions **earlier than 7.0**, use the following policy settings to configure port redirection. For the VDA versions **7.0 through 7.8**, configure these settings using the registry; see [Configure COM Port and LPT Port Redirection settings using the registry](#). For the VDA version **7.9**, use the following policy settings.

Auto connect client COM ports

This setting enables or disables automatic connection of COM ports on user devices when users log on to a site.

By default, client COM ports are not automatically connected.

Auto connect client LPT ports

This setting enables or disables automatic connection of LPT ports on user devices when users log on to a site.

By default, client LPT ports are not connected automatically.

Client COM port redirection

This setting allows or prevents access to COM ports on the user device.

By default, COM port redirection is prohibited.

The following policy settings are related:

- COM port redirection bandwidth limit
- COM port redirection bandwidth limit percent

Client LPT port redirection

This setting allows or prevents access to LPT ports on the user device.

By default, LPT port redirection is prohibited.

LPT ports are used only by legacy applications that send print jobs to the LPT ports. These ports are not used by legacy applications that send print jobs to the print objects on the user device. Most applications today can send print jobs to printer objects. This policy setting is necessary only for servers that host legacy applications that print to LPT ports.

Note, although Client COM port redirection is bi-directional, LPT port redirection is output only and limited to \\client\LPT1 and \\client\LPT2 within an ICA session.

The following policy settings are related:

- LPT port redirection bandwidth limit
- LPT port redirection bandwidth limit percent

Printing policy settings

October 20, 2023

The Printing section contains policy settings for managing client printing.

Client printer redirection

This setting controls whether client printers are mapped to a server when a user logs on to a session.

By default, client printer mapping is allowed. If this setting is disabled, the PDF printer for the session is not auto-created.

Related policy settings: auto-create client printers

Default printer

This setting specifies how the default printer on the user device is established in a session.

By default, the user's current printer is used as the default printer for the session.

To use the current Remote Desktop Services or Windows user profile setting for the default printer, select Do not adjust the user's default printer. If you choose this option, the default printer is not saved in the profile and it does not change according to other session or client properties. The default printer in a session is the first printer auto-created in the session, which is either:

- The first printer added locally to the Windows server in **Control Panel > Devices and Printers**.
- The first auto-created printer, if there are no printers added locally to the server.

You can use this option to present users with the nearest printer through profile settings (known as proximity printing).

Printer assignments

This setting provides an alternative to the Default printer and Session printers settings. Use the individual Default printer and Session printers settings to configure behaviors for a site, large group, or organizational unit. Use the **Printer assignments** setting to assign a large group of printers to multiple users.

This setting specifies how the default printer on the listed user devices is established in a session.

By default, the user's current printer is used as the default printer for the session.

It also specifies the network printers to be auto-created in a session for each user device. By default, no printers are specified.

- When setting the default printer value:
 - To use the current default printer for the user device, select Do not adjust.

To use the current Remote Desktop Services or Windows user profile setting for the default printer, select Do no adjust. If you choose this option, the default printer is not saved in the profile and it does not change according to other session or client properties. The default printer in a session is the first printer auto-created in the session, which is either:

- The first printer added locally to the Windows server in **Control Panel > Devices** and Printers.
 - The first auto-created printer, if there are no printers added locally to the server.
- When setting the session printers value: to add printers, type the UNC path of the printer you want to auto-create. After adding the printer, you can apply customized settings for the current session at every logon.

Printer auto-creation event log preference

This setting specifies the events that are logged during the printer auto-creation process. You can choose to log no errors or warnings, only errors, or errors and warnings.

By default, errors and warnings are logged.

An example of a warning is an event in which a printer's native driver cannot be installed and the Universal print driver is installed instead. To use the Universal print driver in this scenario, configure the Universal print driver usage setting to Use universal printing only or Use universal printing only if the requested driver is unavailable.

Session printers

This setting specifies the network printers to be auto-created in a session. Inside the ICA/HDX session, the Citrix Print Manager service (CpSvc.exe) creates a network printer connection during the session logon for each network printer specified in the **Session Printer** policy setting. It deletes the printers during the session logoff. By default, no printers are specified.

In the **Session Printer** policy setting, the network printers can reside on a Windows Print Server or a Citrix Universal Print Server.

- **Windows Print Server:** Shares one or more network printers. It also has the native printer drivers required to use the network printers.
- **Universal Print Server:** A Windows Print Server where the Citrix Universal Print Server software has been installed.

When using a Windows Print Server, the Citrix Print Manager service creates the network printer connections using native printer drivers. The Citrix Virtual Apps server must have the native printer drivers installed on it.

When using a Citrix Universal Print Server, the Citrix Print Manager service creates the network printer connections using either native printer drivers, Citrix Universal Printer Driver, or Citrix Universal XPS Printer Driver. The driver that you use is controlled by the Universal Print Driver usage policy setting.

All Windows printer drivers currently fall within either the v3 or v4 driver version. For more information, see [Support for the Microsoft V3 and V4 Printer Driver Architectures](#).

To add session printers and verify if they appear in the sessions, complete the following procedure:

1. Sign in to Web Studio, select **Policies** in the left pane, and then click the **Policies** tab.
2. Enable the **Session printers** policy.
3. In the policy, add the session printer. To add printers, type the UNC path of the printer you want to auto-create. After adding the printer, you can apply customized settings for the current session at every logon. The session printer must display in the list.
4. After the policy has been set, the published application might not display session printers. This issue might occur because the printer driver is missing from the Citrix Virtual Apps server or the policy has been created but not enabled.

Note:

If a session printer needs a native printer driver and the native printer driver is not installed on the VDA, then the session printer might not be created in the session.

5. Start the published desktop and manually add the session printer in **Devices and Printers > Control Panel**.
6. If this fails, investigate the communication between the Citrix Virtual Apps server and the print server. Consider running a test with RDP.

Wait for printers to be created

Use the policy on the Delivery Controller to enable the feature on Citrix Virtual Desktops.

Wait for printers to be created (Server Desktop):

This setting allows a delay in connecting to a session so that client-redirected printers can be auto-created.

By default, a connection delay does not occur.

Wait for printers to be created (Citrix Virtual Apps):

Running the following PowerShell cmdlet allows a delay in connecting to virtual apps running on multi-session hosts so that client-redirected printers can be auto-created before the application is opened.

```
Set-BrokerApplication -Name <VirtualAppName> -WaitForPrinterCreation  
$true
```

By default, a connection delay does not occur.

Client printers policy settings

April 5, 2024

The **Client Printers** section includes policy settings for client printers, including settings to auto-create client printers, retain printer properties, and connect to print servers.

Auto-create client printers

This setting specifies the client printers that are auto-created. This setting overrides default client printer auto-creation settings.

By default, all client printers are auto-created.

This setting takes effect only if the **Client printer redirection** setting is present and set to **Allowed**.

When adding this setting to a policy, select an option:

- **Auto-create all client printers** automatically creates all printers on a user device.
- **Auto-create the client's default printer only** automatically creates only the printer selected as the default printer on the user device.
- **Auto-create local (non-network) client printers only** automatically creates only printers directly connected to the user device through an LPT, COM, USB, TCP/IP, or other local port.
- **Do not auto-create client printers** turns off autocreation for all client printers when users log on. Choosing this option causes the Remote Desktop Services (RDS) settings for autocreating client printers to override this setting in lower priority policies.

Auto-create generic universal printer

This setting enables or disables auto-creation of the generic Citrix Universal Printer object for sessions. These sessions include only the sessions where a user device compatible with Universal Printing is in use.

By default, the generic Universal Printer object isn't auto-created.

The following policy settings are related:

- Universal print driver usage

- Universal driver preference

Auto-create PDF universal printer

This setting enables or disables auto-creation of the Citrix PDF printer for sessions using:

- Citrix Workspace app for Windows (starting from VDA 7.19)
- Citrix Workspace app for HTML5
- Citrix Workspace app for Chrome

By default, the Citrix PDF printer is not auto-created.

Client printer names

This setting selects the naming convention for auto-created client printers.

By default, standard printer names are used.

Select **Standard printer names** to use printer names such as “HPLaserJet 4 from client name in session 3.”

Select **Legacy printer names** to use old-style client printer names and to preserve backward compatibility with legacy printers names as present in the XenApp and XenDesktop versions of the product. You can use this option with the current, Citrix Virtual Apps and Desktops versions of the product. An example of a legacy printer name is “Client/clientname#/HPLaserJet 4.” This option is less secure.

When you use Citrix PDF printer in a session launched from Citrix Workspace app for HTML5, set the **Client printer names** setting as default or select **Standard printer names**. If you select **Legacy printer names**, Citrix Workspace app for HTML5 doesn’t support the Citrix PDF Printer option.

Direct connections to print servers

This setting enables or disables direct connections from the virtual desktop or server-hosting applications to a print server for client printers. Here, the client printers are hosted on an accessible network share.

By default, direct connections are enabled.

Enable direct connections if the network print server is not across a WAN from the virtual desktop or server-hosting applications. Direct communication results in faster printing if the network print server and the virtual desktop or server-hosting applications are on the same LAN.

Disable direct connections if the network is across a WAN or has substantial latency or limited bandwidth. Print jobs are routed through the user device where they’re redirected to the network print

server. Data sent to the user device is compressed, so less bandwidth is consumed as the data travels across the WAN.

If two network printers have the same name, the printer on the same network as the user device is used.

Printer driver mapping and compatibility

This setting specifies the driver substitution rules for auto-created client printers.

This setting is configured to exclude Microsoft OneNote and XPS Document Writer from the auto-created client printers list.

When you define driver substitution rules, you can allow or prevent printers to be created with the specified driver. Also, you can allow created printers to use only universal print drivers. Driver substitution overrides or maps the printer driver names the user device provides, substituting an equivalent driver on the server. These rules give server applications access to client printers that have the same drivers as the server, but different driver names.

You can do the following:

- Add a driver mapping
- Edit an existing mapping
- Override custom settings for a mapping
- Remove a mapping
- Change the order of driver entries in the list

When adding a mapping, enter the client printer driver name and then select the server driver you want to replace.

Printer properties retention

This setting specifies whether to store printer properties and where to store them.

By default, the system determines if printer properties are stored on the user device, if available, or in the user profile.

When adding this setting to a policy, select an option:

- Saved on the client device only is for user devices that have a mandatory or roaming profile that is not saved. Choose this option only if all the servers in your environment are running XenApp 5 and later. Also, your users are using Citrix online plug-in versions 9 through 12.x, or Citrix Receiver 3.x.

- Retained in user profile only is for user devices constrained by bandwidth (this option reduces network traffic) and logon speed or for users with legacy plug-ins. This option stores printer properties in the user profile on the server and prevents any properties exchange with the user device. Use this option with MetaFrame Presentation Server 3.0 or earlier and MetaFrame Presentation Server Client 8.x or earlier. This option is applicable only if a Remote Desktop Services (RDS) roaming profile is used.
- Held in profile only if not saved on the client allows the system to determine where printer properties are stored. Printer properties are stored either on the user device, if available, or in the user profile. Although this option is the most flexible, it can also slow logon time and use extra bandwidth for system-checking.
- Do not retain printer properties prevents storing printer properties.

Retained and restored client printers

This setting enables or disables the retention and re-creation of printers on the user device. By default, client printers are auto-retained and auto-restored.

Retained printers are user-created printers that are created again, or remembered, at the start of the next session. When Citrix Virtual Apps recreates a retained printer, it considers all policy settings except the **Auto-create client printers** setting.

Restored printers are printers fully customized by an administrator, with a saved state that is permanently attached to a client port.

Citrix PDF Universal Printer driver

The Citrix PDF Universal Printer driver enables users to print documents opened with hosted applications or applications that are running on virtual desktops delivered by Citrix Virtual Apps and Desktops. When a user selects the **Citrix PDF Printer** option, the driver converts the file to PDF and transfers the PDF to the local device. The PDF is then opened for viewing and printing from a locally attached printer. PDF is one of the formats supported with Citrix Universal Printing (in addition to EMF and XPS).

The PDF printer can be enabled, configured, and set as default using a Citrix Policy. The **Citrix PDF Printer** option is available to users of the Citrix Workspace app for Windows, Chrome, and HTML5.

Note:

A PDF viewer is required for Windows endpoints. The client must have an application that has file type association registered on Windows to open PDF files.

Drivers policy settings

July 27, 2022

The **Drivers** section includes policy settings related to printer drivers.

Automatic installation of in-box printer drivers

Note

This policy does not support VDAs in this release.

This setting enables or disables the automatic installation of printer drivers from the following:

- Windows in-box driver set
- Driver packages staged on the host using `pnputil.exe /a`

By default, these drivers are installed as needed.

Universal driver preference

This setting specifies the order in which universal printer drivers are used, beginning with the first entry in the list.

By default, the preference order is:

- EMF
- XPS
- PCL5c
- PCL4
- PS

You can add, edit, or remove drivers, and change the order of drivers in the list.

Universal print driver usage

This setting specifies when to use universal printing.

By default, universal printing is used only if the requested driver is unavailable.

Universal printing employs generic printer drivers instead of standard model-specific drivers, potentially simplifying the burden of driver management on host computers. The availability of universal

print drivers depends on the capabilities of the user device, host, and print server software. In certain configurations, universal printing might not be available.

When adding this setting to a policy, select an option from the following table:

| Option | Description |
|---|---|
| Use only printer model specific drivers | Specifies that the client printer uses only the standard model-specific drivers that are auto-created during sign in. If the requested driver is unavailable, the client printer cannot be auto-created. |
| Use universal printing only | Specifies that no standard model-specific drivers are used. Only universal print drivers are used to create printers. |
| Use universal printing only if requested driver is unavailable | Uses standard model-specific drivers for printer creation if they are available. If the driver is not available on the server, the client printer is created automatically with the appropriate universal driver. |
| Use printer model specific drivers only if universal printing is unavailable | Uses the universal print driver if it is available. If the driver is not available on the server, the client printer is created automatically with the appropriate model-specific printer driver. |

Universal Print Server policy settings

January 23, 2023

The **Universal Print Server** section includes policy settings for handling the Universal Print Server.

SSL cipher suite

This setting specifies the set of SSL/TLS cipher suites that are used in the Universal Print Client for encrypted print data stream (CGP) connections.

To control the cipher suite package used by the Universal Print Client for encrypted print web service (HTTPS/SOAP) connections, see [SCHANNEL].

Default value: ALL

This setting has the following values: ALL, COM or GOV.

The cipher suites corresponding to each value are the following:

ALL:

TLS_ECDHE_RSA_AES256_GCM_SHA384

TLS_ECDHE_RSA_AES256_CBC_SHA384

TLS_ECDHE_RSA_AES128_CBC_SHA

COM:

TLS_ECDHE_RSA_AES128_CBC_SHA

GOV:

TLS_ECDHE_RSA_AES256_GCM_SHA384

TLS_ECDHE_RSA_AES256_CBC_SHA384

SSL compliance mode

This setting specifies the level of compliance with NIST Special Publication 800-52 that is used by the Universal Print Client for encrypted print data stream (CGP) connections.

Default value: None.

This setting has the following values:

None.

The encrypted print data stream (CGP) connections use the default compliance mode.

SP800-52.

The encrypted print data stream (CGP) connections use the NIST Special Publication 800-52 compliance mode.

SSL enabled

This setting specifies whether SSL/TLS is used by the Universal Print Client for the following:

- Print data stream (CGP) connections
- Web service (HTTP/SOAP) connections

When you set **Universal Print Server enable** to **Enabled with fallback to Windows' native remote printing**, fallback connections are made by the Microsoft Windows Network Print Provider. This setting does not affect these fallback connections.

Default value: Disabled

This setting has the following values:

Enabled.

The Universal Print Client uses SSL/TLS to connect to the Universal Print Server.

Disabled.

The Universal Print Client uses SSL/TLS to connect to the Universal Print Server.

SSL FIPS mode

This setting specifies whether the SSL/TLS cryptographic module used by the Universal Print Client for print data stream (CGP) connections run in FIPS mode.

Default value: Disabled

This setting has the following values:

Enabled.

FIPS mode is on.

Disabled.

FIPS mode is off.

SSL protocol version

This setting specifies the SSL/TLS protocol version used by the Universal Print Client.

Default value: ALL

This setting has the following values:

ALL.

Use TLS versions 1.0, 1.1 or 1.2.

TLSv1.

Use TLS version 1.0.

TLSv1.1.

Use TLS version 1.1.

TLSv1.2.

Use TLS version 1.2.

SSL Universal Print Server encrypted print data stream (CGP) port

This setting specifies the TCP port number of the Universal Print Server encrypted print data stream (CGP) port. This port receives data for print jobs.

Default value: 443

SSL Universal Print Server encrypted web service (HTTPS/SOAP) port

This setting specifies the TCP port number of the Universal Print Server encrypted web service (HTTPS/SOAP) port. This port receives data for print commands.

Default value: 8443

Universal Print Server enable

This policy enables or disables the use of the Citrix Universal Print Server (UPS). Apply this policy setting to Organizational Units (OUs) that includes the virtual desktop or server-hosting applications. This policy settings include fallback options to allow connections to print servers using the native Windows remote printing service in the event that the Citrix UPS component is not installed or unavailable on the requested print server. Changes to this policy is applicable only after the VDA is restarted.

By default, the Universal Print Server is disabled.

When adding this setting to a policy, select one of the following options:

- **Enabled with fallback to Windows native remote printing:** The Universal Print Server services the Network printer connections, if possible. If the Universal Print Server is not available, the Windows Print Provider is used. The Windows Print Provider continues to handle all printers previously created with the Windows Print Provider.
- **Enabled with no fallback to Windows native remote printing:** The Universal Print Server services the Network printer connections exclusively. If the Universal Print Server is unavailable, the network printer connection fails. This setting effectively disables network printing through the Windows Print Provider. Printers previously created with the Windows Print Provider are not created while a policy containing this setting is active.
- **Disabled:** The Universal Print Server feature is disabled. No attempt is made to connect with the Universal Print Server when connecting to a network printer with a UNC name. Connections to remote printers continue to use the Windows native remote printing facility.

Universal Print Server print data stream (CGP) port

This setting specifies the TCP port number used by the Universal Print Server print data stream Common Gateway Protocol (CGP) listener. Apply this policy setting only to OUs containing the print server.

By default, the port number is set to 7229.

Valid port numbers must be in the range of 1-65535.

Universal Print Server print stream input bandwidth limit (Kbps)

This setting specifies the upper boundary (in kilobits per second) for the transfer rate of print data. The transfer rate is calculated for the print data that is delivered from each print job to the Universal Print Server using CGP. Apply this policy setting to OUs containing the virtual desktop or server-hosting applications.

By default, the value is 0, which specifies no upper boundary.

Universal Print Server web service (HTTP/SOAP) port

This setting specifies the TCP port number used by the Universal Print Server's web service (HTTP/SOAP) listener. The Universal Print Server is an optional component that enables the use of Citrix universal print drivers for network printing scenarios.

When the Universal Print Server is used, printing commands are sent from Citrix Virtual Apps and Desktops hosts to the Universal Print Server via SOAP over HTTP. This setting modifies the default TCP port on which the Universal Print Server listens for incoming HTTP/SOAP requests.

You must configure both host and print server HTTP port identically. If you do not configure the ports identically, the host software doesn't connect to the Universal Print Server. This setting changes the VDA on Citrix Virtual Apps and Desktops. In addition, you must change the default port on the Universal Print Server.

By default, the port number is set to 8080.

Valid port numbers must be in the range of 0-65535.

Universal Print Servers for load balancing

This setting lists the Universal Print Servers to be used to load balance printer connections established at session launch, after evaluating other Citrix printing policy settings. To optimize printer creation time, Citrix recommends that all print servers have the same set of shared printers. There is no upper limit to the number of print servers which can be added for load balancing.

This setting also implements print server failover detection and printer connections recovery. The print servers are checked periodically for availability. If a server failure is detected, that server is removed from the load balancing scheme. Also, the printer connections on that server are redistributed among other available print servers. When the failed print server recovers, it is returned to the load balancing scheme.

Click **Validate Servers** to check that each server is a print server, that the server list doesn't include duplicate server names, and that all servers have an identical set of shared printers installed. This operation might take some time.

Universal Print Servers out-of-service threshold

This setting specifies how long the load balancer must wait for an unavailable print server to recover before it determines that the server is permanently offline and redistributes its load to other available print servers.

By default, the threshold value is set to 180 (seconds).

Universal Print Server web service (HTTP/SOAP) connect timeout

This setting specifies the number of seconds that the Universal Print Client must wait until a Universal Print Server web service connect() operation times out. This setting has the following values. All these values are numeric and the units (of time) are seconds.

- The minimum value is 0.
- The maximum value is 60.
- The default value is 10.

When the timeout is between 1 and 60 (inclusive), the Universal Print Client waits for the specified time for the operation to complete. The operation is a connect TCP socket operation. Sockets are a facility of the Windows operating system that allows interprocess communication over TCP/IP networks.

When the timeout is 0, the Universal Print Client uses the default timeout defined by the operating system. This configuration was the available configuration present in the previous versions of the Universal Print Client before this change.

The Universal Print Client is the component of the Virtual Delivery Agent (VDA) that communicates with the Universal Print Server.

Note:

This policy setting is applicable in the VDA version 7.35 and later.

Universal Print Server web service (HTTP/SOAP) receive timeout

This setting specifies the number of seconds that the Universal Print Client must wait until a Universal Print Server web service `recv()` operation times out. This setting has the following values and all these values are numeric and the units (of time) are seconds.

- The minimum value is 0.
- The maximum value is 60.
- The default value is 10.

When the timeout is between 1 and 60 (inclusive), the Universal Print Client waits for the specified time for the operation to complete. The operation is a receive TCP socket operation. Sockets are a facility of the Windows operating system that allows interprocess communication over TCP/IP networks.

When the timeout is 0, the Universal Print Client uses the default timeout defined by the operating system. This configuration was the available configuration present in the previous versions of the Universal Print Client before this change.

Universal Print Client is the component of the Virtual Delivery Agent (VDA) that communicates with the Universal Print Server.

Note:

This policy setting is applicable in the VDA version 7.35 and later.

Universal Print Server web service (HTTP/SOAP) send timeout

This setting specifies the number of seconds that the Universal Print Client must wait until a Universal Print Server web service `send()` operation times out. This setting has the following values. All these values are numeric and the units (of time) are seconds.

- The minimum value is 0.
- The maximum value is 60.
- The default value is 10.

When the timeout is between 1 and 60 (inclusive), the Universal Print Client waits for the specified time for the operation to complete. The operation is a send TCP socket operation. Sockets are a facility of the Windows operating system that allows interprocess communication over TCP/IP networks.

When the timeout is 0, the Universal Print Client uses the default timeout defined by the operating system. This configuration was the available configuration present in the previous versions of the Universal Print Client before this change.

Universal Print Client is the component of the VDA that communicates with the Universal Print Server.

Note:

This policy setting is applicable in the VDA version 7.35 and later.

Universal printing policy settings

July 3, 2022

The **Universal Printing** section includes policy settings for managing universal printing.

Universal printing EMF processing mode

This setting controls the method of processing the EMF spool file on the Windows user device.

By default, EMF records are spooled directly to the printer.

When adding this setting to a policy, select an option:

- Reprocess EMFs for printer forces the EMF spool file to be reprocessed and sent through the GDI subsystem on the user device. You can use this setting for drivers that require EMF reprocessing but that might not be selected automatically in a session.
- Spool directly to printer, when used with the Citrix Universal print driver, ensures the EMF records are spooled and delivered to the user device for processing. Typically, these EMF spool files are injected directly to the client's spool queue. For printers and drivers that are compatible with the EMF format, this is the fastest printing method.

Universal printing image compression limit

This setting specifies the following:

- Maximum quality available for images printed with the Citrix Universal print driver
- Minimum compression level available for images printed with the Citrix Universal print driver

By default, the image compression limit is set to Best quality (lossless compression).

If No Compression is selected, compression is disabled for EMF printing only.

When adding this setting to a policy, select an option:

- No compression
- Best quality (lossless compression)
- High quality

- Standard quality
- Reduced quality (maximum compression)

When adding this setting to a policy that includes the **Universal printing optimization defaults** setting, be aware of the following:

- Consider the compression level in the **Universal printing image compression limit** setting is lower than the level defined in the **Universal printing optimization defaults** setting. In this case, the images are compressed at the level defined in the Universal printing image compression limits setting.
- If compression is disabled, the Desired image quality and Enable heavyweight compression options of the Universal printing optimization defaults setting have no effect in the policy.

Universal printing optimization defaults

This setting specifies the default values for printing optimization when the universal print driver is created for a session.

- Desired image quality specifies the default image compression limit applied to universal printing. By default, Standard Quality is enabled, meaning that users can only print images using standard or reduced quality compression.
- Enable heavyweight compression enables or disables reducing bandwidth beyond the compression level set by Desired image quality, without losing image quality. By default, heavyweight compression is disabled.
- Image and Font Caching settings specify whether to cache images and fonts that appear multiple times in the print stream or not. This setting ensures that each unique image or font is sent to the printer only once. By default, embedded images and fonts are cached. These settings apply only if the user device supports this behavior.
- Allow non-administrators to modify these settings specifies whether users can change the default print optimization settings within a session or not. By default, users aren't allowed to change the default print optimization settings.

Note: All of these options are supported for EMF printing. For XPS printing, only the Desired image quality option is supported.

When adding this setting to a policy that includes the **Universal printing image compression limit** setting, be aware of the following:

- Consider the compression level in the **Universal printing image compression limit** setting is lower than the level defined in the **Universal printing optimization defaults** setting. In this case, the images are compressed at the level defined in the Universal printing image compression limits setting.

- If compression is disabled, the Desired image quality and Enable heavyweight compression options of the Universal printing optimization defaults setting have no effect in the policy.

Universal printing preview preference

This setting specifies whether to use the print preview function for auto-created or generic universal printers.

By default, print preview isn't used for auto-created or generic universal printers.

When adding this setting to a policy, select an option:

- Do not use print preview for auto-created or generic universal printers
- Use print preview for auto-created printers only
- Use print preview for generic universal printers only
- Use print preview for both auto-created and generic universal printers

Universal printing print quality limit

This setting specifies the maximum dots per inch (dpi) available for generating printed output in a session.

By default, No Limit is enabled, meaning users can select the maximum print quality allowed by the printer to which they connect.

If this setting is configured, it limits the maximum print quality available to users in terms of output resolution. Both the print quality itself and the print quality capabilities of the printer to which the user connects are restricted to the configured setting.

For example, if configured to Medium Resolution (600 DPI), users can print the output with a maximum quality of 600 DPI only. Also, the **Print Quality** setting on the **Advanced** tab of the **Universal Printer** dialog box shows resolution settings only up to and including Medium Quality (600 DPI).

When adding this setting to a policy, select an option:

- Draft (150 DPI)
- Low Resolution (300 DPI)
- Medium Resolution (600 DPI)
- High Resolution (1200 DPI)
- No Limit

Security policy settings

July 7, 2022

The **Security** section includes the policy setting for configuring session encryption and encryption of logon data.

SecureICA minimum encryption level

This setting specifies the minimum level at which to encrypt session data sent between the server and a user device.

Important: For the Virtual Delivery Agent 7.x, this policy setting can be used only to enable the encryption of the logon data with RC5 128-bit encryption. Other settings are provided only for backwards compatibility with legacy versions of Citrix Virtual Apps and Desktops.

For the VDA 7.x, encryption of session data is set using the basic settings of the VDA's Delivery Group. If Enable Secure ICA is selected for the Delivery Group, session data is encrypted using RC5 (128 bit) encryption. If Enable Secure ICA is not selected for the Delivery Group, session data is encrypted with Basic encryption.

When adding this setting to a policy, select an option:

- Basic encrypts the client connection using a non-RC5 algorithm. It protects the data stream from being read directly, but it can be decrypted. By default, the server uses Basic encryption for client-server traffic.
- RC5 (128 bit) logon only encrypts the logon data using RC5 128-bit encryption and the client connection using Basic encryption.
- RC5 (40 bit) encrypts the client connection using RC5 40-bit encryption.
- RC5 (56 bit) encrypts the client connection using RC5 56-bit encryption.
- RC5 (128 bit) encrypts the client connection using RC5 128-bit encryption.

The settings you specify for client-server encryption can interact with any other encryption settings in your environment and your Windows operating system. Consider a higher priority encryption level is set on either a server or user device. In this case, the settings you specify for published resources can be overridden.

You can raise encryption levels to further secure communications and message integrity for certain users. If a policy requires a higher encryption level, Citrix Receivers using a lower encryption level are denied connection.

SecureICA does not perform authentication or check data integrity. To provide end-to-end encryption for your site, use SecureICA with TLS encryption.

SecureICA does not use FIPS-compliant algorithms. If this setting is an issue, configure the server and Citrix Receivers to avoid using SecureICA.

SecureICA uses the RC5 block cipher as described in RFC 2040 for confidentiality. The block size is 64 bits (a multiple of 32-bit word units). The key length is 128 bits. The number of rounds is 12.

Keys for the RC5 block cipher are negotiated when a session is created. Negotiation is performed using the Diffie-Hellman algorithm. This negotiation uses Diffie-Hellman public parameters. These parameters are stored in the Windows registry when the Virtual Delivery Agent is installed. Public parameters are not secret. The result of the Diffie-Hellman negotiation is a secret key, from which the session keys for the RC5 block cipher are derived. Separate session keys are used for user logon, and for data transfer. Also, separate session keys are used for traffic to and from the Virtual Delivery Agent. Therefore there are four session keys for each session. The secret keys and session keys are not stored. Initialization vectors for the RC5 block cipher are also derived from the secret key.

Server limits policy settings

July 7, 2022

The **Server Limits** section includes the policy setting for controlling idle connections.

Server idle timer interval

This setting determines how long an uninterrupted user session is maintained if there is no input from the user. The data is calculated in milliseconds.

By default, idle connections are not disconnected (server idle timer interval = 0). Citrix recommends setting this value to a minimum of 60000 milliseconds (60 seconds).

To display the policy, select **Multiple Versions**, clear the Single-session OS versions, and then select **Server Limits**.

Note

When this policy setting is used, an “Idle timer expired” dialog box might appear to users when the session has been idle for the specified time. Citrix policy settings don’t control this Microsoft dialog box message. For more information, see <http://support.citrix.com/article/CTX118618>.

Session limits policy settings

June 13, 2022

The **Session Limits** section includes policy settings that control how long sessions remain connected before they are forced to log off.

Disconnected session timer

This setting enables or disables a timer that specifies how long a disconnected, locked desktop remains locked before the session is logged off.

If this timer is enabled, the disconnected session is logged off when the timer expires.

By default, disconnected sessions aren't logged off.

Remote PC Access disconnected session timer

This setting enables or disables a timer that logs off a disconnected user session after the timer expires. If you enable this setting, use the **Disconnected session timer interval** setting to specify how many minutes a disconnected desktop remain locked before the user session is logged off.

By default, this setting is disabled.

Disconnected session timer interval

This setting specifies how many minutes a disconnected, locked desktop remain locked before the session is logged off.

By default, the time period is 1,440 minutes (24 hours).

Disconnected session timer –Multi-session

This setting enables or disables a timer to determine how long a disconnected RDS session can persist before the session logs off. By default, this timer is disabled and disconnected sessions are not logged off.

Disconnected session timer interval –Multi-session

This setting determines how many minutes, a disconnected RDS session can persist before the session is logged off. By default, the time period is 1440 minutes (24 hours).

Session connection timer

This setting enables or disables a timer that specifies the maximum duration of an uninterrupted connection between a user device and a desktop. If this timer is enabled, the session is disconnected or logged off when the timer expires. The Microsoft **End session when time limits are reached** setting determines the next state for the session.

By default, this timer is disabled.

Session connection timer interval

This setting specifies the maximum number of minutes for an uninterrupted connection between a user device and a desktop.

By default, the maximum duration is 1,440 minutes (24 hours).

Session connection timer –Multi-session

This setting enables or disables a timer that specifies the maximum duration of an uninterrupted connection between a user device and a terminal server. By default, this timer is disabled.

Session connection timer interval –Multi-session

This setting specifies the maximum number of minutes for an uninterrupted connection between a user-device and an RDS session. By default, the maximum duration is 1440 minutes (24 hours).

Session idle timer

When a user supplies no input, this setting is used to enable or disable:

- A timer that specifies how long an uninterrupted user device connection to a desktop is maintained.

When this timer expires, the session is placed in the disconnected state and the **Disconnected session timer** applies. If the **Disconnected session timer** is disabled, the session is not logged off.

By default, this timer is enabled.

Session idle timer interval

When there is no input from the user, this setting is used to specify:

- The number of minutes for which an uninterrupted user device connection to a desktop is maintained.

By default, idle connections are maintained for 1,440 minutes (24 hours).

Session idle timer –Multi-session

This setting enables or disables a timer to determine the maximum duration of an idle connection between a user device and a terminal server. By default, this timer is disabled.

Session idle timer interval–Multi-session

This setting specifies how many minutes an idle connection between a user device and an RDS session. By default, the maximum duration is 1440 minutes (24 hours).

Note:

Timer settings for multi-session machines configured using Citrix policies are expected to override timer settings configured through Microsoft Group Policies. To avoid unexpected behavior, we recommend you configure timer settings using one of the two methods.

Session reliability policy settings

March 8, 2023

The **session reliability** section includes policy settings for managing session reliability connections.

Session reliability connections

This setting allows or prevents sessions to be kept open during a loss of network connectivity. Session reliability, along with auto client reconnection, allows users to reconnect automatically to their Citrix Workspace app sessions after recovering from network disruptions. By default, session reliability is Allowed.

The settings in Web Studio are enforced on the client for the following:

- Citrix Workspace app 1808 and later
- Citrix Receiver for Windows 4.7 and later.

Web Studio policy overrides Citrix Receiver Group Policy Object on the clients. Updates to these policies in Web Studio synchronize session reliability from server to client.

Note:

- Citrix Receiver for Windows 4.7 and later and Citrix Workspace apps for Windows - Set the policy in Web Studio.
- Citrix Receivers for Windows earlier than 4.7 - Set policies in Web Studio. Also set the Citrix Receiver Group Policy Object template on the client for consistent behavior.

Session reliability keeps sessions active and on the user's screen when network connectivity is interrupted. Users continue to see the application that they're using until network connectivity resumes.

Use session reliability, to keep the session active on the server. To indicate that connectivity is lost, the user display becomes opaque. The user might see a frozen session during the interruption. User can resume interacting with the application when the network connection is restored. Session reliability reconnects users without reauthentication prompts.

If you use both session reliability and auto client reconnect, the two features work in sequence. Session reliability closes (or disconnects) the user session after the time specified in the session reliability timeout setting. After that, the auto client reconnect settings take effect, trying to reconnect the user to the disconnected session.

By default, session reliability is Allowed.

Note:

When Citrix ADC is in use, you must select **Enable session reliability** in the Citrix StoreFront > **Manage Citrix Gateways / Secure Ticket Authority** to proxy ICA connections.

Session reliability port number

This setting specifies the TCP port number for incoming session reliability connections.

By default, the port number is set to 2598.

Session reliability timeout

This setting specifies the length of time, in seconds. This time is the time that the session reliability proxy waits for a user to reconnect before allowing the session to be disconnected.

Although you can extend the amount of time a session is kept open, this feature is a convenience and doesn't prompt the user for reauthentication. The longer a session is open, the chances increase that a user might leave the device unattended and potentially accessible to unauthorized users.

By default, the timeout is set to 180 seconds, or three minutes.

Session watermark policy settings

August 18, 2022

The **session watermark** section includes policy settings to configure this feature.

Enabling this feature causes a significant rise in the network bandwidth and CPU usage by the VDA machine. We recommend that you configure the session watermark for selected VDA machines based on your available hardware resources.

Important

Enable session watermark for the other watermark policy settings to be effective. To achieve a better user experience, don't enable more than two watermark text items.

Enable session watermark

When you enable this setting, the session display has an opaque textual watermark displaying session-specific information. The other watermark settings depend on this one being enabled.

By default, the session watermark is disabled.

Include client IP address

When you enable this setting, the session displays the current client IP address as a watermark.

By default, Include client IP address is disabled.

Include connection time

When you enable this setting, the session watermark displays a connect time. The format is yyyy/mm/dd hh:mm. The time displayed is based on the system clock and time zone.

By default, Include connection time is disabled.

Include logon user name

When you enable this setting, the session displays the current logon user name as a watermark. The display format is USERNAME@DOMAINNAME. We recommend that the user name is a maximum of 20 characters. When a user name is more than 20 characters, excessively small character fonts or truncation might occur and lessen the watermark effectiveness.

By default, Include logon user name is enabled.

Include VDA host name

When you enable this setting, the session displays the VDA host name of the current ICA session as a watermark.

By default, Include VDA host name is enabled.

Include VDA IP address

When you enable this setting, the session displays the VDA IP address of the current ICA session as a watermark.

By default, the VDA IP address is disabled.

Session watermark style

This setting controls whether you display a single watermark text label or multiple labels. Choose **Multiple** or **Single** from the **Value** drop-down menu.

Multiple displays five watermark labels in the session. One in the center and four in the corners.

Single displays a single watermark label in the center of the session.

By default, the Session watermark style is Multiple.

Watermark custom text

This setting lets you apply custom text (for example, the corporate name) to display in the session watermark. When you configure a non-empty string, it displays the text in a new line appending other information enabled in the watermark. The watermark custom text is limited to 25 Unicode characters. If you configure a longer string, it is truncated to 25 characters.

There is no default text.

Starting with Citrix Virtual Apps and Desktops 7 2206, you can add more customization using custom tags in the text. As a result, the maximum number of characters in the custom text is increased to 1024.

The available tags for watermark settings are described in the following table:

| Tag | Description | Example |
|-------------------------------------|--|--|
| <code><font=value></code> | Allows you to change the font of watermark text. The value is the name of a font available on the VDA. | <code><font=Courier New></code> |
| <code><fontzoom=value></code> | Allows you to set the percentage of the font zoom factor. The value is 200 for 200% zoom on watermark text. | <code><fontzoom=200></code> |
| <code><position=value></code> | Allows you to change the position of the watermark text. The values are <code>center</code> , <code>topleft</code> , <code>topright</code> , <code>bottomleft</code> , and <code>bottomright</code> . This tag is only applicable with single style. | <code><position=topright></code> |
| <code><rotation=value></code> | Allows you to rotate watermark text. The value is specified in degree and the range is from -360 and 360. | <code><rotation=45></code> |
| <code><style=value></code> | Allows you to change the display style. This tag overrides the Session watermark style policy. | <code><style=single></code> |

The following watermark styles are available:

- Single style - A single watermark text label appears at the center of the session. You can use the position tag to change the location.
- xstyle or multiple - Five watermark labels appear in the session - one in the center and one in each corner.
- Tile - Multiple labels appear in the session. Watermark text is placed equally across the entire screen.

The available tags for changing watermark text are described in the following table:

| Tag | Description |
|------------|--|
| <clientip> | The IP address of the endpoint. |
| <date> | The date the session was established. |
| <domain> | The domain name of the logged-in user account. |
| <hostname> | The machine name of the VDA. |
| <newline> | Creates an extra line. |
| <serverip> | The IP address of the VDA. |
| <time> | The time the session was established. |
| <username> | The name of the user. |

Note:

- The **Watermark custom text** policy takes effect only when the **Enable session watermark** policy is enabled. Its default value is *Disabled*.
- If you use the tags for changing watermark text, all other session watermark policies, except **Enable session watermark**, are ignored. If you use the tags for watermark text settings, you can use all other watermark policies.

Watermark transparency

You can specify watermark opacity from 0 through 100. The larger the value specified, the more opaque the watermark.

By default, the value is 17.

Time zone control policy settings

July 8, 2022

The **Time Zone Control** section includes policy settings related to using local time in sessions.

Estimate local time for legacy clients

This setting enables or disables estimating the local time zone of user devices. These devices include the user devices that send inaccurate time zone information to the server.

By default, the server estimates the local time zone when necessary.

This setting is intended for use with legacy Citrix Receivers or ICA clients that do not send detailed time zone information to the server. Consider that this setting is used with Citrix Receivers that send detailed time zone information to the server. For example, supported versions of Citrix Receiver for Windows. In this case, this setting has no effect.

Restore desktop OS time zone on session disconnect or logoff

Consider that the user disconnects or logs off a session. In this case, this setting determines whether the time zone setting for a Single-session OS VDA is restored to the machine's original time zone. If you enable this setting, the VDA restores the machine's time zone to its original setting when the user disconnects or logs off. For this setting to take effect, set the **Use local time of client** to **Use client time zone**.

By default, this setting is enabled.

Use local time of client

This setting determines the time zone setting of the user session. The choices are the time zone of the user session (server time zone) or the time zone of the user device (client time zone).

By default, the time zone of the user session is used.

For this setting to take effect, enable the **Allow time zone redirection** setting in the Group Policy Editor. The setting is in **Local Computer Policy > Computer Configuration > Administrative Templates > Windows Components > Remote Desktop Services > Remote Desktop Session Host > Device and Resource Redirection**.

If you are using single-session VDA (formerly known as Workstation VDA) on machines running a server OS, configure the local user right **Change the time zone** to **Everyone**. This user right can be found in the **Local Computer Policy > Computer Configuration > Windows Settings > Security Settings > Local Policies > User Rights Assignment**.

Note:

In a Single-session OS, **Users** are included in the User Rights Assignment **Change the time zone**, though not in a Multi-session OS. In a Multi-session OS, the time zone synchronizes using the following group policy: Computer Configuration\Administrative Templates\Windows

Components\Remote Desktop Services\Remote Desktop Session Host\Device and Resource Redirection\Allow timezone redirection. This policy is applicable when the Server is a Remote Desktop Session Host in the Multi-session OS VDA (installed with the `/ServerVDI` command). In a Multi-session OS, by default and by design, users don't have the local right to change the time zone.

TWAIN devices policy settings

July 8, 2022

The **TWAIN devices** section includes policy settings related to the following:

- Mapping client TWAIN devices, such as digital cameras or scanners
- Optimizing image transfers from server to client

Note:

TWAIN 2.0 is supported with Citrix Receiver for Windows 4.5.

Client TWAIN device redirection

TWAIN devices communicate with server-hosted image processing applications by using the TWAIN protocol.

This setting allows or prevents users from accessing TWAIN devices on the user device. By default, TWAIN device redirection is allowed.

The following policy settings are related:

- TWAIN compression level
- TWAIN device redirection bandwidth limit
- TWAIN device redirection bandwidth limit percent

TWAIN compression level

This setting specifies the level of compression of image transfers from client to server. Use Low for best image quality, Medium for good image quality, or High for low image quality. By default, medium compression is applied.

USB devices policy settings

January 23, 2023

The **USB devices** section includes policy settings for managing file redirection for USB devices.

Client USB device optimization rules

Client USB device optimization rules can be applied to devices to disable optimization, or to change the optimization mode.

When a user plugs in a USB input device, the host checks if the **USB policy** settings allow the device. If the device is allowed, the host then checks the **Client USB device optimization rules** for the device. If no rule is specified, then the device is not optimized. Capture mode (04) is the recommended mode for signature devices. For other devices which have degraded performance over higher latency, administrators can enable Interactive mode (02). See descriptions of the available modes in the table in this article.

Good to know

- For the use of Wacom signature pads and tablets, we recommend that you disable the screen saver. Steps on how to disable the screen saver are at the end of this section.
- Support for the optimization of Wacom STU signature pads and tablets series of products has been preconfigured in the installation of Citrix Virtual Apps and Desktops policies.
- Signature devices work across Citrix Virtual Apps and Desktops and do not require a driver to be used as a signature device. Wacom has more software that can be installed to customize the device further. See <http://www.wacom.com/>.
- Drawing tablets. Certain drawing input devices might present as an HID device on PCI/ACPI buses and are not supported. Attach these devices on a USB host controller on the client to be redirected inside a Citrix Virtual Desktops session.

Policy rules take the format of tag=value expressions separated by whitespace. The following tags are supported:

| Tag Name | Description |
|----------|---|
| Mode | The optimization mode is supported for input devices for class= 03 . Supported modes are: No optimization - value 01 . Interactive mode - value 02 . Recommended for devices such as pen tablets and 3D Pro mice. Capture mode - value 04 . Preferred for devices such as signature pads. |
| VID | Vendor ID from the device descriptor, as a four-digit hexadecimal number. |
| PID | Product ID from the device descriptor, as a four-digit hexadecimal number. |
| REV | Revision ID from the device descriptor, as a four-digit hexadecimal number. |
| Class | Class from either the device descriptor or an interface descriptor. |
| SubClass | Subclass from either the device descriptor or an interface descriptor. |
| Prot | Protocol from either the device descriptor or an interface descriptor. |

Examples

Mode=00000004 VID=067B PID=1230 class=03 #Input device operating in capture mode

Mode=00000002 VID=067B PID=1230 class=03 #Input device operating in interactive mode (default)

Mode=00000001 VID=067B PID=1230 class=03 #Input device operating without any optimization

Mode=00000100 VID=067B PID=1230 # Device setup optimization disabled (default)

Mode=00000200 VID=067B PID=1230 # Device setup optimization enabled

Disabling the screen saver for Wacom signature pad devices

For the use of Wacom signature pads and tablets, Citrix recommends that you disable the screen saver as follows:

1. Install the **Wacom-STU-Driver** after redirecting the device.
2. Install **Wacom-STU-Display MSI** to gain access to the signature pad control panel.

3. Go to **Control Panel > Wacom STU Display > STU430** or **STU530**, and select the tab for your model.
4. Choose **Change**, then select **Yes** when the UAC security window pops up.
5. Select **Disable slideshow**, then **Apply**.

After the setting is set for one signature pad model, it is applied to all models.

Client USB device redirection

This setting allows or prevents redirection of USB devices to and from the user device.

By default, USB devices are not redirected.

Client USB device redirection rules

This setting specifies the redirection rules for USB devices.

By default, no rules are specified.

When a user plugs in a USB device, the host device checks it against each policy rule in turn until a match is found. The first match for any device is considered definitive. If the first match is an Allow rule, the device is remoted to the virtual desktop. If the first match is a Deny rule, the device is available only to the local desktop. If no match is found, default rules are used.

Policy rules take the format {Allow: | Deny:} followed by a set of tag= value expressions separated by whitespace. The following tags are supported:

| Tag Name | Description |
|----------|---|
| VID | Vendor ID from the device descriptor |
| PID | Product ID from the device descriptor |
| REL | Release ID from the device descriptor |
| Class | Class from either the device descriptor or an interface descriptor |
| SubClass | Subclass from either the device descriptor or an interface descriptor |
| Prot | Protocol from either the device descriptor or an interface descriptor |

When creating policy rules, remember:

- Rules are case-insensitive.

- Rules can have an optional comment at the end, introduced by #.
- Blank and pure comment lines are ignored.
- Tags must use the matching operator = (for example, VID=067B_).
- Each rule must start on a new line or form part of a semicolon-separated list.
- See the USB class codes available from the USB Implementers Forum, Inc. website.

Examples of administrator-defined USB policy rules:

- Allow: VID=067B PID=0007 # Another Industries, Another Flash Drive
- Deny: Class=08 subclass=05 # Mass Storage
- To create a rule that denies all USB devices, use “DENY:” without other tags.

Client USB plug and play device redirection

This setting allows or prevents plug-and-play devices such as cameras or point-of-sale (POS) devices to be used in a client session.

By default, plug-and-play device redirection is allowed. When set to Allowed, all plug-and-play devices for a specific user or group are redirected. When set to Prohibited, no devices are redirected.

Configure automatic redirection of USB devices

USB devices are automatically redirected when USB support is enabled. Also, the USB user preference settings are set to automatically connect USB devices.

Note:

In Receiver for Windows 4.2, USB devices are also automatically redirected when operating in Desktop Appliance mode. Also, the connection bar is not present. In earlier versions of Citrix Receiver for Windows, USB devices are also auto-redirected when operate in the following:

- Desktop appliance mode
- Virtual machine (VM) hosted applications

It is not always best to redirect all USB devices. Users can explicitly redirect devices from the USB device list that is not automatically redirected. To prevent USB devices from being listed or redirected, use DeviceRules on either the client endpoint or the DDC policy. See Administration Guides for further details.

Caution:

Using the Registry Editor incorrectly can cause serious problems that might require you to reinstall your operating system. Citrix cannot guarantee that problems resulting from the incorrect use of the Registry Editor can be solved. Use the Registry Editor at your own risk. Be sure to back

up the registry before you edit it.

User preferences settings for auto redirection of USB devices

Policy:

1. Open **Local Group Policy Editor** and go to **Administrative Templates > Citrix Components > Citrix Receiver > Remoting client devices > Generic USB Remoting**.
2. Open **New USB Devices**, select **Enabled**, and click **OK**.
3. Open **Existing USB Devices**, select **Enabled**, and click **OK**.

Citrix Receiver:

1. Go to **Citrix Receiver Preferences > Connections**.
2. Ensure that the following options are selected:
 - When a session starts, connect devices automatically
 - When a new device is connected while a session is running, connect the device automatically.
3. Click **OK**.

All the registry keys and the policy changes are applied to the Windows client device.

Plain USB printers redirection

The best solution for plain USB printers is to use the dedicated Universal Printer Driver and virtual channel to perform printing. By default, plain USB printers are not automatically redirected.

Plain printers are detected using heuristics. Also, it is expected that advanced printers with scanning functions for example, might need to be redirected using USB support to work completely.

Use this registry to configure whether plain printers are automatically redirected:

HKEY_LOCAL_MACHINE\SOFTWARE\Citrix\ICA Client\GenericUSB\Devices

Name: AutoRedirectPrinters

Type: DWORD

Data: 00000000

The default value is 0 (does not automatically redirect). Changing the value to any number greater than zero enables USB support to redirect plain USB printers.

You can also deploy Active Directory policies to this registry key and override the non-policy value if both are present:

HKEY_LOCAL_MACHINE\SOFTWARE\Policies\Citrix\ICA Client\GenericUSB\Devices

Name: AutoRedirectAudio

Type: DWORD

Data: 00000000

Plain audio devices redirection

Like plain printers, the best user experience is achieved using the dedicated audio virtual channel of ICA to send audio data from plain audio devices. However, you might need to redirect some specialty devices using USB support. Heuristics are used to determine which devices are plain audio devices.

Use this registry on client endpoint to configure whether plain audio devices are automatically redirected:

HKEY_LOCAL_MACHINE\SOFTWARE\Citrix\ICA Client\GenericUSB\Devices

Name: AutoRedirectAudio

Type: DWORD

Data: 00000000

The default is set to 0 (does not automatically redirect). Changing the value to non-zero, redirects plain USB audio devices with USB support.

You can use Active Directory policies to deploy this value to the registry key and override the non-policy value if both are present:

HKEY_LOCAL_MACHINE\SOFTWARE\Policies\Citrix\ICA Client\GenericUSB\Devices

Name: AutoRedirectVideo

Type: DWORD

Data: 00000000

Plain storage devices (mass storage device) redirection

For plain storage devices, you achieve the best user experience using the dedicated virtual channel, such as client drive mapping that also performs optimization. In addition to simple reading or writing files, to perform certain special tasks like burning a CD/DVD or accessing encrypted file systems devices, the device might still need to be redirected using generic USB support.

Heuristics are used to determine which devices are plain storage devices. Use this registry key to configure whether plain storage devices are automatically redirected:

HKEY_LOCAL_MACHINE\SOFTWARE\Citrix\ICA Client\GenericUSB\Devices

Name: AutoRedirectStorage

Type: DWORD

Data: 00000000

The default is set to 0 (does not automatically redirect). Changing the value to non-zero, redirects plain USB storage devices using generic USB support.

You can also use Active Directory policies to deploy this value to the following registry key and override the non-policy value if both are present:

HKEY_LOCAL_MACHINE\SOFTWARE\Policies\Citrix\ICA Client\GenericUSB\Devices

Name: AutoRedirectStorage

Type: DWORD

Data: 00000000

Note:

Read only access to the plain storage device is not configurable if you are using generic USB support, while it is configurable if using CDM.

USB flash drives with hardware encryption redirection

USB flash drives with hardware encryption typically consist of an encrypted storage partition and a second *utility* partition that contains a utility for unlocking the encrypted partition. For USB Flash Drive devices, achieve the best user experience using the dedicated client drive mapping/dynamic thumb drive mapping HDX virtual channel that also performs optimization.

Generic USB redirection is necessary for the following:

- Non-Windows clients (for example, Linux clients)
- Clients where the customer has restricted (locked down) user access to local functions on the client

Generic USB redirection can redirect any USB storage device without hardware encryption into both Single-session OS and Multi-session OS VDA sessions.

Before Citrix Virtual Apps and Desktops 7 1808, USB flash drives with hardware encryption could not be redirected in any useful way into Single-session OS or Multi-session OS VDA sessions. A new feature enhancement introduced in Citrix Virtual Apps and Desktops 7 1808 supports generic USB redirection of USB flash drives with hardware encryption into Single-session OS and Multi-session OS VDA sessions.

After the device is redirected, none of its drives appear on the local client. So, if unlocking the drive is required, perform it in the session. This feature requires Windows update KB4074590.

Plain still image devices (scanners and digital cameras)

For plain still image devices, achieve the best user experience using the dedicated virtual channel (such as the TWAIN virtual channel) that also performs optimization. These devices must adhere to industry standards. Consider that a device is non-compliant or it is not used according to the original intentions. In this case, generic USB redirection might be the only way to use the device. Heuristics are used to determine which devices are plain still image devices.

Use this registry key to configure whether plain still image devices are automatically redirected:

HKEY_LOCAL_MACHINE\SOFTWARE\Citrix\ICA Client\GenericUSB\Devices

Name: AutoRedirectImage

Type: DWORD

Data: 00000000

The default is set to 0 (does not automatically redirect). Changing the value to non-zero, redirects plain USB still image devices with generic USB.

You can also use Active Directory policies to deploy this value to this registry key and override the non-policy value if both are present:

HKEY_LOCAL_MACHINE\SOFTWARE\Policies\Citrix\ICA Client\GenericUSB\Devices

Name: AutoRedirectImage

Type: DWORD

Data: 00000000

Device specific settings

The heuristics used to select Citrix optimizable devices do not always match what you want. The examples for Citrix optimizable devices are printers, audio, video, storage, and still image devices. You might want to control automatic redirection of devices that are not listed above. You can control automatic redirection on a device specific basis.

As an example, the DemoTech 2,000 bar code reader doesn't need to be redirected using USB support. It has a vendor identifier of 12AB and a product identifier of 5678. These hexadecimal numbers can be found in Device Manager.

To prevent this being automatically redirected, create this device specific registry key:

HKEY_LOCAL_MACHINE\SOFTWARE\Citrix\ICA Client\GenericUSB\Devices\VID12AB PID5678

Name: AutoRedirect

Type: DWORD

Data: 00000000

A value of 0 prevents the device from being automatically redirected. A non-zero value indicates that the device must be considered for automatic redirection (subject to user preferences). There is a single space character between the vendor and product identifiers.

You can also deploy this value using Active Directory policies to this registry key. It overrides the non-policy value if both are present:

HKEY_LOCAL_MACHINE\SOFTWARE\Policies\Citrix\ICA Client\GenericUSB\Devices\VID12AB
PID5678

Name: AutoRedirect

Type: DWORD

Data: 00000000

Device specific AutoRedirect settings take precedence over the more general AutoRedirectXXX values explained above. The default heuristics for Citrix optimized devices might misinterpret a device as generic. Therefore, set the device specific AutoRedirect value to 1 to redirect it automatically.

Allow existing USB devices to be automatically connected

This setting allows or prevents the automatic connection of the existing USB devices that are connected to the endpoint at the start of a session to the remote session.

When adding this setting to a policy, select one of the following options:

- Ask before redirecting available USB devices.
- Do not automatically redirect available USB devices.
- Automatically redirect available USB devices.

By default, the **Ask before redirecting available USB devices** option is selected. Based on the policy selected, the option selected at the client's **Preferences > Devices** section can be overridden.

Note:

Currently, the **Allow existing USB devices to be automatically connected** policy is applicable only for Citrix Workspace app for Windows.

Allow newly arrived USB devices to be automatically connected

This setting allows or prevents the automatic connection of the USB devices that are inserted at the endpoint during a session to the remote session.

When adding this setting to a policy, select one of the following options:

- Ask before redirecting available USB devices.
- Do not automatically redirect available USB devices.
- Automatically redirect available USB devices.

By default, the **Ask before redirecting available USB devices** option is selected. Based on the policy selected, the option selected at the client's **Preferences > Devices** section can be overridden.

Note:

Currently, the **Allow newly arrived USB devices to be automatically connected** policy is applicable only for Citrix Workspace app for Windows.

Client USB device redirection rules (Version 2)

This setting specifies rules for filtering, splitting, and auto-connecting USB devices to a remote session.

When this setting is selected, the host overrides the *Client USB device redirection rules* setting with the device rules configured in this setting.

For more information, see [Configuring composite USB device redirection](#).

Virtual channel allow list policy settings

November 22, 2023

The **Virtual channel allow list** policy setting enables the use of an allow list that specifies which virtual channels are allowed to be opened in an ICA session.

When disabled, all virtual channels are allowed.

When enabled, only Citrix virtual channels are allowed.

To use custom or third-party virtual channels, add the virtual channels to the list. To add a virtual channel to the list:

1. Enter the virtual channel name followed by a comma.
2. Enter the path to the process that accesses the virtual channel.

More executable paths can be listed, and the paths are separated by commas.

For example,

```
CTXCV1,C:\VC1\vhost.exe
```

```
CTXCV2,C:\VC2\vhost.exe,C:\Program Files\Third Party\vcaccess.exe
```

Starting with Citrix Virtual Apps and Desktops 7 2109, virtual channel allow lists are enabled by default. For more information on adding virtual channels to the allow list, see [Adding virtual channels to the allow list](#)

If you're using the HDX RealTime Optimization Pack for Skype for Business, add the virtual channel to the allow list. For more information, see the [HDX RealTime Optimization Pack documentation](#).

Important:

The VDA machines must be rebooted for the setting to take effect.

For more information about virtual channels, see [ICA virtual channels](#).

Virtual channel allow list logging

You can use this policy setting to configure the level for Virtual Channel Allow List logging.

The following options are available:

| Options | Description |
|-------------------|--|
| Disabled | Disables all log events. |
| Log warnings only | Events are logged only for custom Virtual Channels that try to open and that are not part of the allow list. |
| Log all events | All events are logged |

Virtual channel allow list log throttling

You can use this policy setting to configure the frequency for logging events for an active session.

All events for each virtual channel will be logged on their first occurrence. Repeated events will be suppressed for the duration of the throttling period while the session is active. If a session is disconnected, the throttling period is reset.

Visual display policy settings

July 17, 2022

The **Visual Display** section includes policy settings for controlling the quality of images that are sent from virtual desktops to the user device.

Preferred color depth for simple graphics

This policy setting is available in VDA versions 7.6 FP3 and later. The 8-bit option is available in VDA versions 7.12 and later.

This setting makes it possible to lower the color depth at which simple graphics are sent over the network. Lowering to 8-bit or 16-bit per pixel potentially improves responsiveness over low bandwidth connections. However, this action might cost slight degradation in image quality. The 8-bit color depth is not supported when the [Use video codec for compression](#) policy setting is set to **For the entire screen**.

The default preferred color depth is 24-bits per pixel.

VDAs fall back to 24-bit (default) color depth if the 8-bit setting is applied on VDA version 7.11 and earlier.

Target frame rate

This setting specifies the maximum number of frames per second sent from the virtual desktop to the user device.

By default, the maximum is 30 frames per second.

Setting a high number of frames per second (for example, 30) improves the user experience, but requires more bandwidth. Decreasing the number of frames per second (for example, 10) maximizes server scalability at the expense of user experience. For user devices with slower CPUs, specify a lower value to improve the user experience.

The maximum supported frame rate per second is 60.

Visual quality

This setting specifies the desired visual quality for images displayed on the user device.

By default, this setting is Medium.

To specify the quality of images, choose one of the following options:

- **Low** - Recommended for bandwidth-constrained networks where visual quality can be sacrificed for interactivity
- **Medium** - Offers the best performance and bandwidth efficiency in most use cases
- **High** - Recommended if you require visually lossless image quality
- **Build to lossless** - Sends lossy images to the user device during periods of high network activity and lossless images after network activity reduces. This setting improves performance over bandwidth-constrained network connections
- **Always lossless** - When preserving image data is vital, select **Always lossless** to ensure that lossy data is never sent to the user device. For example, when displaying X-ray images where no loss of quality is acceptable.

Moving images policy settings

January 11, 2024

The **Moving Images** section contains settings that enable you to remove or alter compression for dynamic images.

Minimum image quality

Note: For the Virtual Delivery Agent 7.x, this policy setting applies only when the Legacy graphics mode policy setting is enabled.

This setting specifies the minimum acceptable image quality for Adaptive Display. The less compression used, the higher the quality of images displayed. Choose from Ultra High, Very High, High, Normal, or Low compression.

By default, this is set to Normal.

Moving image compression

This setting specifies whether or not Adaptive Display is enabled. Adaptive Display automatically adjusts the image quality of videos and transitional slides in slide shows based on available bandwidth. With Adaptive Display enabled, users should see smooth-running presentations with no reduction in quality.

By default, Adaptive Display is enabled.

For VDA versions 7.0 through 7.6, this setting applies only when Legacy graphics mode is enabled. For VDA versions 7.6 FP1 and later, this setting applies when Legacy graphics mode is enabled, or when the legacy graphics mode is disabled and a video codec is not used to compress graphics.

When legacy graphics mode is enabled, the session must be restarted before policy changes take effect. Adaptive Display is mutually exclusive with Progressive Display; enabling Adaptive Display disables Progressive Display and vice versa. However, both Progressive Display and Adaptive Display can be disabled at the same time. Progressive Display, as a legacy feature, is not recommended for XenApp or XenDesktop. Setting Progressive threshold Level will disable Adaptive Display.

Progressive compression level

Note: For the Virtual Delivery Agent 7.x, this policy setting applies only when the Legacy graphics mode policy setting is enabled.

This setting provides a less detailed but faster initial display of images.

By default, no progressive compression is applied.

The more detailed image, defined by the normal lossy compression setting, appears when it becomes available. Use Very High or Ultra High compression for improved viewing of bandwidth-intensive graphics such as photographs.

For progressive compression to be effective, its compression level must be higher than the Lossy compression level setting.

Note: The increased level of compression associated with progressive compression also enhances the interactivity of dynamic images over client connections. The quality of a dynamic image, such as a rotating three-dimensional model, is temporarily decreased until the image stops moving, at which time the normal lossy compression setting is applied.

The following policy settings are related:

- Progressive compression threshold value
- Progressive heavyweight compression

Progressive compression threshold value

Note: For the Virtual Delivery Agent 7.x, this policy setting applies only when the Legacy graphics mode policy setting is enabled.

This setting represents the maximum bandwidth in kilobits per second for a connection to which progressive compression is applied. This is applied only to client connections under this bandwidth.

By default, the threshold value is 2147483647 kilobits per second.

The following policy settings are related:

- Progressive compression threshold value
- Progressive heavyweight compression

Target minimum frame rate

This setting specifies the minimum frame rate per second the system attempts to maintain, for dynamic images, under low bandwidth conditions.

By default, this is set to 10fps.

For VDA versions 7.0 through 7.6, this setting applies only when Legacy graphics mode is enabled. For VDA versions 7.6 FP1 and later, this setting applies when the Legacy graphics mode is disabled or enabled.

Note:

The target minimum framerate policy has been deprecated and is set to 10 fps. This can be changed by end users by using the Quality slider in the Graphic status indicator.

Still images policy settings

May 30, 2022

The **Still Images** section contains settings that enable you to remove or alter compression for static images.

Extra color compression

This setting enables or disables the use of extra color compression on images delivered over client connections that are limited in bandwidth, improving responsiveness by reducing the quality of displayed images.

By default, extra color compression is disabled.

When enabled, extra color compression is applied only when the client connection bandwidth is below the Extra color compression threshold value. When the client connection bandwidth is above the threshold value or Disabled is selected, extra color compression is not applied.

Extra color compression threshold

Note: For the Virtual Delivery Agent 7.x, this policy setting applies only when the Legacy graphics mode policy setting is enabled.

This setting represents the maximum bandwidth in kilobits per second for a connection below which extra color compression is applied. If the client connection bandwidth drops below the set value, extra color compression, if enabled, is applied.

By default, the threshold value is 8192 kilobits per second.

Heavyweight compression

Note: For the Virtual Delivery Agent 7.x, this policy setting applies only when the Legacy graphics mode policy setting is enabled.

This setting enables or disables reducing bandwidth beyond progressive compression without losing image quality by using a more advanced, but more CPU-intensive, graphical algorithm.

By default, heavyweight compression is disabled.

If enabled, heavyweight compression applies to all lossy compression settings. It is supported on Citrix Workspace app but has no effect on other plug-ins.

The following policy settings are related:

- Progressive compression level
- Progressive compression threshold value

Lossy compression level

Note: For the Virtual Delivery Agent 7.x, this policy setting applies only when the Legacy graphics mode policy setting is enabled.

This setting controls the degree of lossy compression used on images delivered over client connections that are limited in bandwidth. In such cases, displaying images without compression can be slow.

By default, medium compression is selected.

For improved responsiveness with bandwidth-intensive images, use high compression. Where preserving image data is vital; for example, when displaying X-ray images where no loss of quality is acceptable, you may not want to use lossy compression.

Related policy setting: Lossy compression threshold value

Lossy compression threshold value

Note: For the Virtual Delivery Agent 7.x, this policy setting applies only when the Legacy graphics mode policy setting is enabled.

This setting represents the maximum bandwidth in kilobits per second for a connection to which lossy compression is applied.

By default, the threshold value is 2147483647 kilobits per second.

Adding the Lossy compression level setting to a policy and including no specified threshold can improve the display speed of high-detail bitmaps, such as photographs, over a LAN.

Related policy setting: Lossy compression level

WebSockets policy settings

July 25, 2022

The **WebSockets** section includes policy settings for accessing virtual desktops and hosted applications using the Citrix Workspace app for HTML5. The WebSockets feature increases security and reduces overhead by conducting two-way communication between browser-based applications and servers. The feature does so without opening multiple HTTP connections.

WebSockets connections

This setting allows or prohibits WebSockets connections.

By default, WebSocket connections are prohibited.

WebSockets port number

This setting identifies the port for incoming WebSocket connections.

By default, the value is 8008.

WebSockets trusted origin server list

This setting provides a comma-separated list of trusted origin servers, usually the Citrix Workspace app for Web, expressed as URLs. The server accepts only WebSockets connections originating from one of these addresses.

By default, the wildcard * is used to trust all Citrix Workspace app for Web URLs.

If you choose to type an address in the list, use this syntax:

<protocol>://<Fully qualified domain name of host>:[port]

The protocol must be HTTP or HTTPS. If the port is not specified, port 80 is used for HTTP and port 443 is used for HTTPS.

The wildcard * can be used within the URL, except as part of an IP address (10 . 105 . * . *).

WIA devices policy settings

July 17, 2022

The **WIA devices** section includes policy settings for managing scanner redirection using Windows Image Acquisition (WIA).

WIA redirection

WIA devices, such as digital cameras and scanners, communicate with server-hosted image processing applications by using the WIA framework. This setting allows or prohibits users from accessing WIA devices on the user device. By default, WIA redirection is prohibited.

For information about WIA-compliant devices, see [WIA devices](#).

HDX features managed through the registry

April 10, 2024

Note:

Editing the registry incorrectly can cause serious problems that might require you to reinstall your operating system. Citrix cannot guarantee that problems resulting from the incorrect use of the Registry Editor can be solved. Use Registry Editor at your own risk. Be sure to back up the registry before you edit it.

To open the Registry Editor, run `regedit.exe` on the server. Then navigate to the registry key to add or edit the settings.

Devices

Bloomberg keyboards

Citrix Virtual Apps and Desktops support the Bloomberg model 4 and model 3 starboard keyboard. By default, the support for the enhanced Bloomberg keyboard is disabled.

To enable support for the Bloomberg keyboard, set the following registry value on the client machine before you start a connection:

- **Key:** `HKEY_LOCAL_MACHINE\SOFTWARE\Citrix\ICAClient\GenericUSB`

- **Value name:** `EnableBlombergHID`
- **Value type:** `DWORD`
- **Value data:**
 - 0 - Disable
 - 1 - Enable

For more information, see [Blomberg keyboard](#).

Mapped client drives

As a security precaution, when a user logs in to Citrix Virtual Apps and Desktops, by default, the server maps client drives without user run permission. To enable users to run executable files residing on mapped client drives, override this default by editing the registry on the server.

To allow access, edit the following registry value (create **CDMSettings** if it doesn't exist):

- **Key:** `HKEY_LOCAL_MACHINE\SOFTWARE\Policies\Citrix\CDMSettings`
- **Value name:** `ExecuteFromMappedDrive`
- **Value type:** `DWORD`
- **Value data:**
 - 1 - Allow permission
 - 0 - Deny permission on mapped drives

The change takes effect for sessions connected after you edit the registry.

Citrix Virtual Apps and Desktops 7 2006 is the first version to contain this registry location. Earlier versions of Citrix Virtual Apps and Desktops used a different registry location.

For more information, see [Client Drive Mapping](#).

Microsoft Surface Pro and Surface Book pens

Citrix Virtual Apps and Desktops support standard pen functionality with Windows Ink-based applications. By default, this feature is enabled.

To disable or enable this feature, set the following registry value:

- **Key:** `HKEY_LOCAL_MACHINE\SOFTWARE\Citrix\Citrix Virtual Desktop Agent\PenApi`
- **Value name:** `DisablePen`
- **Value type:** `DWORD`
- **Value data:**

- 1 - Disable
- 0 - Enable

For more information, see [Microsoft Surface Pro and Surface Book pens](#).

Windows Image Acquisition application allow list

This setting lets you control which applications on the VDA can access the Windows Image Acquisition scanner redirection.

By default, no applications have access to Windows Image Acquisition.

To adjust Windows Image Acquisition for applications on the VDA, create the following registry setting:

- **Key:** `HKEY_LOCAL_MACHINE\SOFTWARE\Citrix`
- **Value name:** `WIAAllowedProcesses`
Select and right-click **WIAAllowedProcesses**. Choose **New > Multi-String Value** and rename the new value to **AllowProcesses**.
- **Value data:** Enter the full path and process name for each application that can access Windows Image Acquisition. Provide each application on a new line.

Any changes to this setting take effect the next time you launch a session on the VDA.

General

HDX Reducer

You can configure the version of the HDX compression algorithm (Reducer) that you want to use in the session host.

To enable Reducer V4 in a single-session VDA, set the following registry value:

Key: `HKEY_LOCAL_MACHINE\SOFTWARE\Citrix\GroupPolicy\Defaults\WDSettings`

Value name: `ReducerOverrideMask`

Value type: `DWORD`

Value data: 23 (Decimal)

To enable Reducer V4 in a multi-session VDA, set the following registry value:

- **Key:** `HKEY_LOCAL_MACHINE\SYSTEM\CurrentControlSet\Control\Terminal Server\Wds\icawd`

- **Value name:** `ReducerOverrideMask`
- **Value type:** `DWORD`
- **Value data:** 23 (Decimal)

Configure EDT timeout

You can configure EDT timeout to any value between 5 and 25 seconds on the VDA. The default EDT timeout value is 25 seconds.

- **Key:** `HKLM\SYSTEM\CurrentControlSet\Control\Terminal Server\Wds\icawd\Tds\udp\UDPStackParameters`
- **Value type:** `DWORD`
- **Value name:** `edtConnectionTimeout`
- **Value data:** time in seconds between 5 and 25 (decimal)

You can also configure the timeout for Citrix Workspace app for Windows:

- **Key:** `HKLM\SOFTWARE\WOW6432Node\Citrix\ICA Client\Engine\Lockdown Profiles\All Regions\Lockdown\Network\EDT`
- **Value type:** `String / REG_SZ`
- **Value name:** `edtConnectionTimeout`
- **Value data:** time in seconds between 5 and 25 (decimal)

Configure Rendezvous version

To configure the version of Rendezvous to use, set the following registry value:

- **Key:** `HKEY_LOCAL_MACHINE\SOFTWARE\Citrix\VirtualDesktopAgent`
- **Value type:** `DWORD`
- **Value name:** `GctRegistration`
- **Value data:**
 - 1 - To enable V2
 - 0 - To enable V1

Configure automatic logon to the VDA

This setting lets you enable or disable the **Always prompt for password** Microsoft policy setting on the Windows 10 single-session OS and multi-session OS VDAs.

If **Always prompt for password** is enabled, users must enter credentials on the VDA when they start a remote session. If this setting is disabled, users automatically connect to the remote session without providing credentials on the VDA.

By default, the Microsoft policy setting is disabled. To enable or disable the **Always prompt for password** setting, set the following registry value on the VDA:

- **Key:** `HKEY_LOCAL_MACHINE\SOFTWARE\Citrix\Portica`
- **Value name:** `AutoLogon`
- **Value type:** `DWORD`
- **Value data:**
 - 1 - Disables the Microsoft policy setting and lets users automatically sign in to a remote session.
 - 0 - Enables the Microsoft policy setting and prompts users to provide credentials when they launch a remote session.

Disable timeout warning

By default, users with inactive or idle sessions receive a warning message two minutes before their session automatically disconnects.

This setting disables and removes the warning message for users reaching the idle session timeout limit on the following:

- Windows Server 2004
- Windows 10 multi-session 2004 or later multi-session OS

To remove the warning, set the following registry value on the VDA:

- **Key:** `HKEY_LOCAL_MACHINE\SYSTEM\CurrentControlSet\Control\Terminal Server\Winstations\ICA-CGP`
- **Value name:** `fEnableTimeoutWarning`
- **Value type:** `DWORD`
- **Value data:**
 - 1 - Disable the warning message
 - 0 - Enable the warning message

To display the warning message, delete the registry value or set it to 0.

EDT MTU Discovery

MTU Discovery allows EDT to automatically determine the Maximum Transmission Unit (MTU) when establishing a session. Doing so prevents EDT packet fragmentation that might result in performance

degradation or failure to establish a session.

This setting is enabled by default. To disable EDT MTU Discovery, configure the following registry value and restart the VDA.

- **Key:** `HKEY_LOCAL_MACHINE\SYSTEM\CurrentControlSet\Control\Terminal Server\Wds\icawd`
- **Value name:** `MtuDiscovery`
- **Value type:** `DWORD`
- **Value data:** `0`

This setting is machine-wide and affects all sessions connecting from a supported client.

Enable loss tolerant mode

You can access adaptive audio using the loss tolerant mode for bidirectional audio service for Citrix Workspace app for Windows, Multi-user VDA, and Desktop VDA. This setting is disabled by default. To enable loss tolerant mode, depending on the machine you are using, configure the following registry value and restart the respective machine.

For Citrix Workspace app for Windows client,

- **Key:** `HKEY_LOCAL_MACHINE\SOFTWARE\WOW6432Node\Citrix\ICA Client\Engine\Configuration\Advanced\Modules\ClientAudio`
- **Value name:** `EdtUnreliableAllowed`
- **Value type:** `REG_SZ`
- **Value data:** `1`

For TS VDA,

- **Key:** `HKEY_LOCAL_MACHINE\SOFTWARE\WOW6432Node\Citrix\Audio`
- **Value name:** `EdtUnreliableAllowed`
- **Value type:** `DWORD`
- **Value data:** `1`

For WS VDA,

- **Key:** `HKEY_LOCAL_MACHINE\SOFTWARE\Citrix\Audio`
- **Value name:** `EdtUnreliableAllowed`
- **Value type:** `DWORD`
- **Value data:** `1`

General content redirection

Add URL types for host to client redirection

By default, we support redirection of the following URL types: HTTP, HTTPS, RTSP, RTSPU, PNM, and MMS. You can add URL types to the list by creating the following registry keys and values on the Windows client.

- **Key:** `HKEY_LOCAL_MACHINE\SOFTWARE\Wow6432Node\Policies\Citrix\ICA Client\SFTA`
- **Value name:** `ExtraURLProtocols`
- **Value type:** `REG_SZ`
- **Value data:** Specify the required URL types separated by semicolon. Include everything before the authority portion of the URL. For example:
`ftp://;mailto;;customtype1://;customtype2://`

You can add URL types only for Windows clients. Clients missing this registry setting reject redirection back to the Citrix session. The client must have an application installed and configured to handle the specified URL types.

For more information, see [Host to client redirection](#).

Client folder redirection

Client folder redirection changes the way client-side files are accessible on the host-side session. Consider that you enable client folder redirection on the server and the user configures it on the user device. In this case, the portion of the local volume specified by the user is redirected.

To enable client folder redirection on the server, set the following registry value:

- **Key:** `HKEY_LOCAL_MACHINE\SOFTWARE\Wow6432Node\Citrix\Client Folder Redirection`
- **Value name:** `CFROnlyModeAvailable`
- **Value type:** `DWORD`
- **Value data:** `1`

For more information, see [Client folder redirection](#).

Host to client redirection for a specific set of websites

To enable host to client redirection for a specific set of websites, set the following registry value on the server VDA.

- **Key:** `HKEY_LOCAL_MACHINE\SOFTWARE\Wow6432Node\Citrix\SFTA`
- **Value name:** `ValidSites`
- **Value type:** `REG_MULTI_SZ`
- **Value data:** Specify any combination of fully qualified domain names (FQDNs). Type multiple FQDNs on separate lines. Include the FQDN only, without protocols (`http://` or `https://`). An FQDN can include an asterisk (*) as a wildcard character in the leftmost position only. This wildcard matches a single level of domain, which is consistent with the rules in RFC 6125. For example:

`www.example.com`

`*.example.com`

For more information, see [Host to client redirection](#).

Local application behavior on logoff and disconnect

By default, local applications continue to run when a user logs off or disconnects from the virtual desktop. After reconnection, local applications are reintegrated if they are available on the virtual desktop. To configure local application behavior on logoff and disconnect, set the following registry value in the hosted desktop:

- **Key:** `HKEY_LOCAL_MACHINE\SOFTWARE\wow6432node\Citrix\Client Hosted Apps\Policies`
- **Value name:** `Session State`
- **Value type:** `DWORD`
- **Value data:**
 - 1 - Local applications continue to run when a user logs off or disconnects from the virtual desktop. Upon reconnection, local applications are reintegrated if they are available on the virtual desktop.
 - 3 - Local applications close when a user logs off or disconnects from the virtual desktop.

For more information, see [Local App Access and URL redirection](#).

Remove URL types from the default list for host to client redirection

To remove URL types from the default redirection list, create the following registry keys and values on the server VDA.

- **Key:** `HKEY_LOCAL_MACHINE\SOFTWARE\Wow6432Node\Citrix\SFTA`
- **Value name:** `DisableServerFTA`

- **Value type:** `DWORD`
- **Value data:** `1`
- **Value name:** `NoRedirectClasses`
- **Value type:** `REG_MULTI_SZ`
- **Value data:** Specify any combination of the values: `http`, `https`, `rtsp`, `rtspu`, `pnm`, or `mms`. Type multiple values on separate lines. For example:

`http`

`https`

`rtsp`

For more information, see [Host to client redirection](#).

Server VDA default browser configuration

You can enable host to client redirection to supersede any default browser configuration on the Server VDA. If a web URL is not redirected, the Citrix launcher passes the URL to the browser configured in the `command_backup` registry key. The key points to Internet Explorer by default, but you can modify it to include the path to a different browser.

- Internet Explorer (Default)
 - **Key:** `HKEY_CLASSES_ROOT\http\shell\open\command_backup`
 - **Value name:** `Default`
 - **Value type:** `REG_SZ`
 - **Value data:** `"c:\program files\internet explorer\iexplore.exe"%1"`
 - **Key:** `HKEY_CLASSES_ROOT\https\shell\open\command_backup`
 - **Value name:** `Default`
 - **Value type:** `REG_SZ`
 - **Value data:** `"c:\program files\internet explorer\iexplore.exe"%1"`
- Google Chrome
 - **Key:** `HKEY_CLASSES_ROOT\http\shell\open\command_backup`
 - **Value name:** `Default`
 - **Value type:** `REG_SZ`

- **Value data:** "C:\Program Files (x86)\Google\Chrome\Application\chrome.exe"%1"
- **Key:** HKEY_CLASSES_ROOT\https\shell\open\command_backup
- **Value name:** Default
- **Value type:** REG_SZ
- **Value data:** "C:\Program Files (x86)\Google\Chrome\Application\chrome.exe"%1"
- Microsoft Edge
 - **Key:** HKEY_CLASSES_ROOT\http\shell\open\command_backup
 - **Value name:** Default
 - **Value type:** REG_SZ
 - **Value data:** "C:\Program Files (x86)\Microsoft\Edge\Application\msedge.exe"%1"
 - **Key:** HKEY_CLASSES_ROOT\https\shell\open\command_backup
 - **Value name:** Default
 - **Value type:** REG_SZ
 - **Value data:** "C:\Program Files (x86)\Microsoft\Edge\Application\msedge.exe"%1"

The Local App Access for published applications

Local App Access seamlessly integrates locally installed Windows applications into a hosted desktop environment without switching from one desktop to another. To provide access to published applications, set the following registry value on the server:

- **Key:** HKEY_LOCAL_MACHINE\SOFTWARE\Wow6432Node\Citrix\DesktopStudio
- **Value name:** ClientHostedAppsEnabled
- **Value type:** DWORD
- **Value data:**
 - 1 - Enable
 - 0 - Disable

For more information, see [Local App Access and URL redirection](#).

Graphics

GPU acceleration for CUDA or OpenCL applications

GPU acceleration of CUDA and OpenCL applications running in a user session is disabled by default.

To use the CUDA acceleration POC features, enable the following registry setting:

- **Key:** `HKEY_LOCAL_MACHINE\SOFTWARE\Wow6432Node\Citrix\CtxHook\AppInit_Dlls\Graphics Helper`
- **Value name:** `CUDA`
- **Value type:** `DWORD`
- **Value data:** `00000001`

To use the OpenCL acceleration POC features, enable the following registry setting:

- **Key:** `HKEY_LOCAL_MACHINE\SOFTWARE\Wow6432Node\Citrix\CtxHook\AppInit_Dlls\Graphics Helper`
- **Value name:** `OpenCL`
- **Value type:** `DWORD`
- **Value data:** `00000001`

For more information, see [GPU acceleration for Windows multi-session OS](#)

Progressive mode

Progressive mode is disabled by default. You can change the progressive mode state with the following registry value:

- **Key:** `HKEY_LOCAL_MACHINE\SOFTWARE\Citrix\Graphics`
- **Value type:** `REG_DWORD`
- **Value name:** `ProgressiveDisplay`
- **Value data:**
 - 0 - Always off (Disables progressive mode. This value is the default.)
 - 1 - Automatic (Toggle based on network conditions.)
 - 2 = Always on

For more information, see [Progressive mode](#).

Note:

Progressive mode has been deprecated. Thinwire is an alternative option that optimizes image

delivery and maintains cache efficiency while providing nearly all of the benefits of the progressive mode.

Windows Presentation Foundation (WPF) rendering

HDX 3D Pro allows graphics-heavy applications running in Windows Multi-session OS sessions to render on the server's graphics processing unit (GPU). By moving Windows Presentation Foundation (WPF) rendering to the server's GPU, graphics rendering does not slow the server's CPU.

To enable WPF application rendering using the server's GPU, create the following setting in the registry of the server running Windows multi-session OS:

1. Open the Registry Editor on the VDA and go to the following key:

```
HKLM\Software\Citrix\CtxHook\AppInit_DLLs\Graphics Helper
```

2. Create or edit the following registry values:

- [REG_DWORD] AdapterHandle = 0x00000001
- [REG_DWORD] DevicePath = 0x00000001
- [REG_DWORD] Flag = 0x00000412
- [REG_DWORD] WPF = 0x00000001

3. Create a sub-key with the executable name of your WPF app. For example, if your app is called "mywpfapp.exe", create the following key:

```
HKLM\Software\Citrix\CtxHook\AppInit_DLLs\Graphics Helper\mywpfapp.exe
```

4. Reboot the server for the setting to take effect.

For more information, see [GPU acceleration for Windows multi-session OS](#) and the blog on [Getting the best out of WPF apps on Windows multi-session OS](#).

Multimedia

Avoid echo during multimedia conferences

Citrix Virtual Apps and Desktops provide an echo cancellation option that minimizes any echo. This feature is enabled by default. To disable echo cancellation, you can change one of the following registry settings:

- **Key:**

- 32-bit: `HKEY_LOCAL_MACHINE\SOFTWARE\Citrix\ICA Client\Engine\Configuration\Advanced\Modules\ClientAudio`

- 64-bit: `HKEY_LOCAL_MACHINE\SOFTWARE\Wow6432Node\Citrix\ICA Client\Engine\Configuration\Advanced\Modules\ClientAudio`

- **Value name:** `EchoCancellation`
- **Value type:** `DWORD`
- **Value data:** `False`

For more information, see [Audio features](#).

Audio limitation

After you install an audio device on your client, enable the audio redirection, and start an RDS session, the audio files might not play audio. As a workaround, add the following registry key on the RDS machine and then restart the machine:

- **Key:** `HKEY_LOCAL_MACHINE\SYSTEM\CurrentControlSet\Control\SCMConfig`
- **Value name:** `EnableSvchostMitigationPolicy`
- **Value type:** `DWORD`
- **Value data:** `0`

For more information, see [Audio features](#).

Browser content redirection and DPI

When using browser content redirection with the DPI (scaling) set to anything over 100% on the user's machine, the redirected browser content screen is incorrectly displayed. To avoid the issue, disable browser content redirection GPU acceleration for Chrome by creating the following registry value on the user's machine:

- **Key:** `HKEY_LOCAL_MACHINE\SOFTWARE\WOW6432Node\Citrix\HdxMediaStream`
- **Value name:** `GPU`
- **Value type:** `DWORD`
- **Value data:** `0`

For more information, see [Browser content redirection and DPI](#).

High-definition webcam streaming

The video conferencing application on the server selects the webcam format and resolution based on the supported format types. Citrix Virtual Apps and Desktops support webcam resolutions up to 1920x1080. To disable and enable the high-definition webcam streaming, add the following registry value:

- **Key:** `HKEY_LOCAL_MACHINE\SOFTWARE\Citrix\HDXRealTime`
- **Value name:** `Enable_HighDefWebcam`
- **Value type:** `DWORD`
- **Value data:**
 - 0 - Disable the high-definition webcam streaming
 - 1 - Enable the high-definition webcam streaming

High-definition webcam resolution

If the media type negotiation fails, HDX falls back to the default VGA resolution (640 x 480 pixels). You can use registry keys on the client to configure the default resolution. Before setting the following registry keys, ensure that the camera supports the specified resolution.

- **Key:** `HKEY_CURRENT_USER\SOFTWARE\Citrix\HDXRealTime`
- Width
 - **Value name:** `DefaultWidth`
 - **Value type:** `DWORD`
 - **Value data:** desired width in decimal (for example: 1280)
- Height
 - **Value name:** `DefaultHeight`
 - **Value type:** `DWORD`
 - **Value data:** desired height in decimal (for example 720)

High-definition webcam bandwidth

HDX webcam video compression uses less bandwidth compared to plug-and-play generic USB redirection and works well over WAN connections. To adjust the bandwidth, set the following registry value on the client:

- **Key:** `HKEY_CURRENT_USER\SOFTWARE\Citrix\HDXRealTime`
- **Value name:** `TargetBitrate`
- **Value type:** `DWORD`
- **Value data:** 350000

Enter a value in bits per second. If you don't specify the bandwidth, the video conferencing applications use 350000 bps by default.

For more information, see [HDX webcam video compression](#).

Microsoft Teams fallback mode

If Microsoft Teams fails to load in optimized VDI mode (“Citrix HDX Not Connected” in Teams/About/Version), the VDA falls back to legacy HDX technologies, such as webcam redirection and client audio and microphone redirection. If you are using a Workspace app version/platform OS that does not support Microsoft Teams optimization, fallback registry keys do not apply.

To control the fallback mechanism, set one of the following registry values on the VDA:

- **Key** (only one needed):
 - **Computer setting:** `HKEY_LOCAL_MACHINE\SOFTWARE\Microsoft\Teams`
 - **User setting:** `HKEY_CURRENT_USER\SOFTWARE\Microsoft\Office\Teams`
- **Value name:** `DisableFallback`
- **Value type:** `DWORD`
- Value data:
 - 1 - Disable fallback mode
 - 2 - Enable audio only

If the value isn't present or is set to 0, fallback mode is enabled. This feature requires Microsoft Teams version 1.3.0.13565 or later. For more information, see [Optimization for Microsoft Teams](#).

Optimization for Microsoft Teams with Citrix App Layering

If using Citrix App Layering to manage VDA and Microsoft Teams installations in different layers, create an empty registry key named **PortICA** on Windows before installing Microsoft Teams with the `ALLUSER=1` flag from the command line. Leave the default value name, type, and data.

- Key for 32-bit Version of Registry Editor: `HKEY_LOCAL_MACHINE\SOFTWARE\WOW6432Node\Citrix\PortICA`
- Key for 64-bit Version of Registry Editor: `HKEY_LOCAL_MACHINE\SOFTWARE\Citrix\PortICA`

For more information, see [Optimization for Microsoft Teams](#).

Single sign-on with Integrated Windows Authentication for browser content redirection

This setting provides single sign-on to a web server configured with Integrated Windows Authentication (IWA) within the same domain as the VDA. To enable single sign-on, set the following registry value to 1:

- **Key:**

- HKEY_LOCAL_MACHINE\SOFTWARE\Citrix\HdxMediastream

or

- HKEY_LOCAL_MACHINE\SOFTWARE\Policies\Citrix\HdxMediastream

- **Value name:** `WebBrowserRedirectionIwaSupport`
- **Value type:** `DWORD`
- **Value data:** `1`

For more information, see [Single sign-on with Integrated Windows Authentication](#).

User-agent request header

The user-agent header helps identify HTTP requests sent from browser content redirection. This setting can be useful when you configure the proxy and firewall rules. For example, if the server blocks the requests sent from browser content redirection, you can create a rule that contains the user-agent header to bypass certain requirements. Only Windows devices support the user-agent request header.

By default, the user-agent request header string is disabled. To enable the user-agent header for client-rendered content, use the Registry editor.

On each Citrix Workspace app for Windows clients, set one of the following registry settings:

- **Key:**
 - 32-bit: `HKEY_LOCAL_MACHINE\SOFTWARE\Citrix\HdxMediaStream`
 - 64-bit: `HKEY_LOCAL_MACHINE\SOFTWARE\WOW6432Node\Citrix\HdxMediaStream`
- **Value name:** `EnableCefUserAgentString`
- **Value type:** `DWORD`
- **Value data:** `1`

After you add the registry value, the user-agent header contains the `CitrixBCR/2102.1` text, where `2102.1` is the Citrix Workspace app for the Windows version.

Webcam software compression

If a webcam supports hardware encoding, HDX video compression uses the hardware encoding by default. Hardware encoding might consume more bandwidth than software encoding. To force software compression, add the following values to the client:

- **Key:** HKEY_CURRENT_USER\SOFTWARE\Citrix\HdxRealTime
- **Value name:** DeepCompress_ForceSWEncode
- **Value type:** DWORD
- **Value data:** 1

For more information, see [HDX webcam video compression](#).

Webcam video compression

HDX webcam video compression sends the H.264 video directly to the video conferencing application running in the virtual session. To optimize VDA resources, HDX webcam compression doesn't encode, transcode, and decode webcam video. This feature is enabled by default.

To disable direct video streaming from the server to the video conferencing app, set the following registry value in the VDA.

- **Key:** HKEY_LOCAL_MACHINE\SOFTWARE\Citrix\HdxRealTime
- **Value name:** OfferH264ToApp
- **Value type:** DWORD
- **Value data:** 0

For more information, see [HDX webcam video compression](#).

Webcam video compression frame rate

To adjust the preferred video frame rate, edit the following registry value on the client:

- **Key:** HKEY_CURRENT_USER\SOFTWARE\Citrix\HDXRealTime
- **Value name:** FramesPerSecond
- **Value type:** DWORD
- **Value data:** 15

If the webcam doesn't support the specified frame rate, the application uses 15 FPS by default.

For more information, see [HDX webcam video compression](#).

Load management policy settings

July 17, 2022

The **Load Management** section includes policy settings for enabling and configuring load management between servers delivering Windows Multi-session OS machines.

For information about calculating the load evaluator index, see [CTX202150](#).

Concurrent logon tolerance

This setting specifies the maximum number of concurrent logons that a server can accept.

By default, this value is set to 2.

When this setting is enabled, load balancing tries to avoid having more than the specified number of logons active on a Server VDA at the same time. However, the limit is not strictly enforced. To enforce the limit (and cause concurrent logons that exceed the specified number to fail), create the following registry key:

```
HKLM\Software\Citrix\DesktopServer\LogonTolerancelsHardLimit
Type: DWORD
Value: 1
```

CPU usage

This setting specifies the level of CPU usage, as a percentage, at which the server reports a full load. When enabled, the default value at which the server reports a full load is 90%.

By default, this setting is disabled and CPU usage is excluded from load calculations.

CPU usage excluded process priority

Note:

In scenarios where Workspace Environment Management manages machines, using this setting along with the [CPU Priority](#) settings can have unintended results. We recommend that you disable this setting if you choose to use the CPU Priority settings.

This setting specifies the priority level at which a process' CPU usage is excluded from the CPU Usage load index.

By default, this value is set to **Below Normal** or **Low**.

Disk usage

This setting specifies the disk queue length at which the server reports a 75% full load. When enabled, the default value for disk queue length is 8.

By default, this setting is disabled and disk usage is excluded from load calculations.

Maximum number of sessions

This setting specifies the maximum number of sessions a server can host. When enabled, the default setting for the maximum number of sessions a server can host is 250.

By default, this setting is enabled.

Memory usage

This setting specifies the level of memory usage, as a percentage, at which the server reports a full load. When enabled, the default value at which the server reports a full load is 90%.

By default, this setting is disabled and memory usage is excluded from load calculations.

Memory usage base load

This setting specifies an approximation of the base operating system's memory usage. Also, defines, in MB, the memory usage below which a server is considered to have zero load.

By default, this value is set to 768 MB.

Profile Management policy settings

March 8, 2023

This section contains policy settings for enabling and configuring Profile Management.

For other information, such as the following, see [Profile Management policies](#):

- Names of the equivalent .ini file setting
- Which version of Profile Management is required for a policy setting

Advanced policy settings

November 13, 2023

Number of retries when accessing locked files

Sets the number of retries when accessing locked files.

If this policy is disabled, the default value of five retries is used. If this policy is not configured here, the value from the .ini file is used. If this policy is not configured here or in the .ini file, the default value is used.

Process Internet cookie files on logoff

Some deployments leave extra Internet cookies that `Index.dat` does not reference. The extra cookies left in the file system after sustained browsing can lead to profile bloat. This policy lets you enable Profile Management to force processing of `Index.dat` and remove the extra cookies. The policy increases logoff times, so enable it only after you experience this issue.

If this policy is not configured here, the value from the .ini file is used. If this policy is configured neither here nor in the .ini file, no processing of `Index.dat` takes place.

Disable automatic configuration

Profile Management examines any Citrix Virtual Desktops environment, for example for the presence of personal vDisks, and configures Group Policy accordingly. Only Profile Management policies in the Not Configured state are adjusted, so any customizations you have made are preserved.

This policy lets you speed up deployment and simplifies optimization. You do not need to configure this policy. However, you can disable automatic configuration when doing one of the following:

- Upgrading to retain settings from earlier versions
- Troubleshooting

You can regard automatic configuration as a dynamic configuration checker that automatically configures the default policy settings according to environments at runtime. It eliminates the need to configure the settings manually. Runtime environments include:

- Windows OS
- Windows OS versions
- Presence of Citrix Virtual Desktops
- Presence of personal vDisks

Automatic configuration might change the following policies if the environment changes:

- Active write-back
- Always cache

- Delete locally cached profiles on logoff
- Delay before deleting cached profiles
- Profile streaming

See the following table for the default status of the policies on different OSs:

| | Multi-session OS | Single-session OS |
|--|------------------|--|
| Active write back | Enabled | <i>Disabled</i> if Personal vDisk is in use; otherwise, enabled. |
| Always cache | Disabled | <i>Disabled</i> if Personal vDisk is in use; otherwise, enabled. |
| Delete locally cached profiles on logoff | Enabled | <i>Disabled</i> if one of the following situations occurs: Personal vDisk is in use, Citrix Virtual Desktops is assigned, or Citrix Virtual Desktops is not installed; otherwise, enabled. |
| Delay before deleting cached profiles | 0 seconds | 60 seconds if user changes are not persistent; otherwise, 0 seconds. |
| Profile streaming | Enabled | <i>Disabled</i> if Personal vDisk is in use; otherwise, enabled. |

However, with automatic configuration disabled, all policies above default to **Disabled**.

Important:

Personal vDisk is deprecated. For details, see [Remove PVD, AppDisks, and unsupported hosts](#).

Starting with Profile Management 1909, you can have an improved experience with the Start menu on Windows 10 (version 1607 and later) and Windows Server 2016 and later. This improvement is achieved through automatic configuration of the following policies:

- Add `Appdata\Local\Microsoft\Windows\Caches` and `Appdata\Local\Packages` to **Folders to Mirror**.
- Add `Appdata\Local\Microsoft\Windows\UsrClass.Dat*` to **Files to synchronize**.

If this setting is not configured here, the value from the .ini file is used.

If this setting is neither configured here nor in the .ini file, automatic configuration is turned on. In this case, Profile Management settings might change if the environment changes.

Log off user if a problem is encountered

Lets you specify whether Profile Management logs off users if a problem is encountered.

If this policy is disabled or not configured, Profile Management gives a temporary profile to users if a problem is encountered. For example, the user store is unavailable.

If it is enabled, an error message is displayed and users are logged off. This setup can simplify troubleshooting of the problem.

If this setting is not configured here, the value from the .ini file is used.

If this setting is neither configured here nor in the .ini file, a temporary profile is provided.

Customer Experience Improvement Program

By default, the Customer Experience Improvement Program is enabled to help improve the quality and performance of Citrix products by collecting anonymous statistics and usage data.

If this setting is not configured here, the value from the .ini file is used.

Enable search index roaming for Outlook

Allow user-based Outlook search experience by automatically roaming Outlook search data along with user profile. This feature requires extra spaces in the user store to store search indexes for Outlook.

Log off and then log on again for this policy to take effect.

Outlook search index database –backup and restore

Lets you specify what Profile Management does during logon when the Enable search index roaming for Outlook policy is enabled.

If this policy is enabled, Profile Management backs up the search index database each time the database is mounted successfully on logon. Profile Management treats the backup as the good copy of the search index database. When an attempt to mount the search index database fails due to database corruption, Profile Management reverts the search index database to the last-known good copy.

Note:

Profile Management deletes the previously saved backup after a new backup is saved successfully. The backup consumes the available VHDX storage.

Enable concurrent session support for Outlook search data roaming

Lets Profile Management provide native Outlook search experience in concurrent sessions of the same user. Use this policy with the Search index roaming for Outlook policy.

With this policy enabled, each concurrent session uses a separate Outlook OST file.

By default, only two VHDX disks can be used to store Outlook OST files (one file per disk). If the user starts more sessions, their Outlook OST files are stored in the local user profile. You can specify the maximum number of VHDX disks for storing Outlook OST files.

Enable OneDrive container

Lets OneDrive folders roam with users.

The OneDrive container is a VHDX-based folder roaming solution. Profile Management creates a VHDX file per user on a file share and stores the users' OneDrive folders into the VHDX files. The VHDX files are attached when users log on and detached when users log off.

UWP app roaming

Lets you enable UWP (Universal Windows Platform) apps to roam with users. As a result, users can access the same UWP apps from different devices.

With this policy enabled, Profile Management lets UWP apps roam with users by storing the apps on separate VHDX disks. Those disks are attached during user logons and detached during user logoffs.

Configuration precedence:

If this setting is not configured here, the value from the .ini file is used.

If this setting is configured neither here nor in the .ini file, this feature is disabled.

Enable asynchronous processing for user Group Policy on logon

Windows provides two processing modes for user Group Policy: synchronous and asynchronous. Windows uses a registry value to determine the processing mode for the next user logon. If the registry value doesn't exist, synchronous mode is applied. The registry value is a machine-level setting and doesn't roam with users. Thus, asynchronous mode will not be applied as expected if users:

- Log on to different machines.
- Log on to the same machine where the Delete locally cached profiles on logoff policy is enabled.

With this policy enabled, the registry value roams with users. As a result, processing mode is applied each time users log on.

Free space ratio to trigger VHD disk compaction

Applicable when [Enable VHD disk compaction](#) is enabled. Lets you specify the free space ratio to trigger VHD disk compaction. When the free space ratio exceeds the specified value on user logoff, disk compaction is triggered.

Free space ratio = (current VHD file size – required minimum VHD file size*) ÷ current VHD file size

* Obtained using the `GetSupportedSize` method of the `MSFT_Partition` class from the Microsoft Windows operating system.

Number of logoffs to trigger VHD disk compaction

Applicable when [Enable VHD disk compaction](#) is enabled. Lets you specify the number of user logoffs to trigger VHD disk compaction.

When the number of logoffs since the last compaction reaches the specified value, disk compaction is triggered again.

Disable defragmentation for VHD disk compaction

Applicable when [Enable VHD disk compaction](#) is enabled. Lets you specify whether to disable file defragmentation for VHD disk compaction.

When VHD disk compaction is enabled, the VHD disk file is first automatically defragmented using the Windows built-in `defrag` tool, and then compacted. VHD disk defragmentation produces better compaction results while disabling it can save system resources.

Enable multi-session write-back for profile containers

Enables write-back for profile containers in multi-session scenarios. If enabled, changes in all sessions are written back to profile containers. Otherwise, only changes in the first session are saved because only the first session is in read/write mode in profile containers. Citrix Profile Management profile containers are supported starting with Citrix Profile Management 2103. FSLogix Profile Container is supported starting with Citrix Profile Management 2003.

To use this policy for the FSLogix Profile Container, ensure that the following prerequisites are met:

- The FSLogix Profile Container feature is installed and enabled.
- The profile type is set to **Try for read-write profile and fallback to read-only** in FSLogix.

Replicate user stores

Lets you replicate the remote user profile store to multiple paths on each logon and logoff. Doing so lets Profile Management provide profile redundancy for user logons.

Enabling the policy increases system I/O and might prolong logoffs.

Note:

- This feature is available for both the user store and the full profile container.
- Replicated profile containers provide profile redundancy for user logons but not for in-session failover.

Enable credential-based access to user stores

By default, Citrix Profile Management impersonates the current user to access the user store. Enable this feature if you do not want Profile Management to impersonate the current user when accessing the user store. You can put user stores in storage repositories (for example, Azure Files) that the current user has no permission to access.

To ensure that Profile Management can access user stores, save the profile storage server's credentials in Workspace Environment Management (WEM) or Windows Credential Manager. We recommend you use Workspace Environment Management to eliminate the need of configuring the same credentials for each machine where Profile Management runs. If you use the Windows Credential Manager, use the Local System account to securely save the credentials.

Note:

This policy is available both for file-based and VHDX-based user stores. For Profile Management versions earlier than 2212, this policy is available only for VHDX-based user stores.

If this setting is not configured here, the value from the .ini file is used. If this setting is configured neither here nor in the .ini file, it is disabled by default.

Customize storage path for VHDX files

Profile Management provides the following VHDX-based policies: Profile container, Search index roaming for Outlook, and Accelerate folder mirroring. By default, VHDX files are stored in the user store. This policy lets you specify a separate path to store them.

Default capacity of VHD containers

Lets you specify the default storage capacity (in GB) of VHD containers.

Configuration precedence:

1. If this policy is not configured here, the value from the .ini file is used.
2. If this policy is not configured either here or in the .ini file, the default is 50 (GB).

Automatically reattach VHDX disks in sessions

With this policy enabled, Profile Management ensures a high level of stability of VHDX-based policies. By default, this policy is enabled.

When this policy is enabled, Profile Management monitors VHDX disks that are in use by VHDX-based policies. If any of the disks is detached, Profile Management reattaches the disk automatically.

Profile container auto-expansion threshold

Lets you specify the utilization percentage of storage capacity at which profile containers trigger auto-expansion.

Configuration precedence:

- If this policy is not configured here, the value from the .ini file is used.
- If this policy is not configured here or in the .ini file, the default is 90 (%) of storage capacity.

Profile container auto-expansion increment

Lets you specify the amount of storage capacity (in GB) by which profile containers automatically expand when auto-expansion is triggered.

Configuration precedence:

- If this policy is not configured here, the value from the .ini file is used.
- If this policy is not configured either here or in the .ini file, the default is 10 (GB).

Profile container auto-expansion limit

Lets you specify the maximum storage capacity (in GB) to which profile containers can automatically expand when auto-expansion is triggered.

Configuration precedence:

- If this policy is not configured here, the value from the .ini file is used.
- If this policy is not configured either here or in the .ini file, the default is 80 (GB).

Enable user-level policy settings

With this policy enabled, machine-level policy settings can work at the user level, and user-level settings override machine-level settings.

Configuration precedence:

1. If this policy is not configured here, the value from the .ini file is used.
2. If this policy is configured neither here nor in the .ini file, it is disabled.

Set priority order for user groups

Lets you specify the priority order for user groups. The order determines which group takes precedence when a user belongs to multiple groups with different policy settings.

When a user belongs to multiple groups with conflicting policy settings, consider the following:

- If the user belongs to one or more groups defined in this policy, the group with the highest priority takes precedence.
- If the user doesn't belong to any of the groups defined in this policy, the group with the SID listed earliest in alphabetical order takes precedence.

User store selection method

Lets you specify the user store selection method when multiple user stores are available. Options include:

- **Configuration order.** Profile Management selects the earliest configured store.
- **Access performance.** Profile Management selects the store with the best access performance.

Configuration precedence:

1. If this setting isn't configured here, the value from the .ini file is used.
2. If this setting isn't configured here or in the .ini file, **Configuration order** is used.

Basic policy settings

February 15, 2023

This section contains policy settings relating to the basic configuration of Profile Management.

Enable Profile Management

By default, to facilitate deployment, Profile Management does not process logons or logoffs. Enable Profile Management only after carrying out all other setup tasks and testing how Citrix user profiles perform in your environment.

If this policy is not configured here, the value from the .ini file is used. If this policy is not configured here or in the .ini file, Profile Management does not process Windows user profiles in any way.

Processed groups

Both computer-local groups and domain groups (local, global, and universal) can be used. Domain groups must be specified in the format: DOMAIN NAME\GROUP NAME.

If this policy is configured here, Profile Management processes only members of these user groups. If this policy is disabled, Profile Management processes all users. If this policy is not configured here, the value from the .ini file is used. If this policy is not configured here or in the .ini file, members of all user groups are processed.

Excluded groups

You can use computer local groups and domain groups (local, global, and universal) to prevent particular user profiles from being processed. Specify domain groups in the form DOMAIN NAME\ GROUP NAME.

If this setting is configured here, Profile Management excludes members of these user groups. If this setting is disabled, Profile Management does not exclude any users. If this setting is not configured here, the value from the .ini file is used. If this setting is not configured here or in the .ini file, no members of any groups are excluded.

Process logons of local administrators

Specifies whether logons of members of the BUILTIN\Administrators group are processed. Consider this policy is disabled or not configured on multi-session operating systems, such as Citrix Virtual Apps environments. In this case, Profile Management assumes that logons by domain users, but not local administrators, must be processed. On single-session operating systems (such as Citrix Virtual Desktops environments), local administrator logons are processed. This policy allows domain users with local administrator rights, typically Citrix Virtual Desktops users with assigned virtual desktops, to:

- Bypass any processing
- Log on

- Troubleshoot the desktop-experiencing problems with Profile Management

Note: Domain users' logons might be subject to restrictions imposed by group membership, typically to ensure compliance with product licensing.

If this policy is disabled, Profile Management does not process logons by local administrators. If this policy is not configured here, the value from the .ini file is used. If this policy is not configured here or in the .ini file, administrators are not processed.

Path to user store

Sets the path to the directory (the user store) in which the user settings (registry changes and synchronized files) are saved.

The path can be:

- A relative path. It must be relative to the home directory (which is typically configured as the #homeDirectory# attribute for a user in the Active Directory).
- A UNC path. It typically specifies a server share or a DFS namespace.
- Disabled or unconfigured. In this case, a value of #homeDirectory#\Windows is assumed.

The following types of variables can be used for this policy:

- System environment variables enclosed in percent signs (for example, %ProfVer%). System environment variables generally require extra setup.
- Attributes of the Active Directory user object enclosed in hashes (for example, #sAMAccountName#).
- Profile Management variables. For more information, see the Profile Management variables product document.

User environment variables cannot be used, except for %username% and %userdomain%. You can also create custom attributes to define organizational variables such as location or users fully. Attributes are case-sensitive.

Examples:

- \server\share#sAMAccountName# stores the user settings to the UNC path \server\share\JohnSmith (if #sAMAccountName# resolves to JohnSmith for the current user)
- \server\profiles\$\%USERNAME%.%USERDOMAIN%!CTX_OSNAME!!CTX_OSBITNESS! might expand to \server\profiles\$\JohnSmith.DOMAINCONTROLLER1\Win8x64

Important: Whichever attributes or variables you use, check that this policy expands to the folder one level higher than the folder containing NTUSER.DAT. For example, if this file is contained in \server\profiles\$\JohnSmith.Finance\Win8x64\UPM_Profile, set the path to the user store as \server\profiles\$\JohnSmith.Finance\Win8x64 (not the \UPM_Profile subfolder).

For more information on using variables when specifying the path to the user store, see the following topics:

- Share Citrix user profiles on multiple file servers
- Administer profiles within and across OUs
- High availability and disaster recovery with Profile Management

If Path to user store is disabled, the user settings are saved in the Windows subdirectory of the home directory.

If this policy is disabled, the user settings are saved in the Windows subdirectory of the home directory. If this policy is not configured here, the value from the .ini file is used. If this policy is not configured here or in the .ini file, the Windows directory on the home drive is used.

Migrate user store

Specifies the path to the folder where the user settings (registry changes and synchronized files) were previously saved (the user store path that you previously used).

If this setting is configured, the user settings that are stored in the previous user store are migrated to the current user store specified in the “Path to user store” policy.

The path can be an absolute UNC path or a path relative to the home directory.

In both cases, you can use the following types of variables:

- System environment variables enclosed in percent signs
- Attributes of the Active Directory user object enclosed in hash signs

Examples:

- The folder `Windows\%ProfileVer%` stores the user settings in a subfolder called `Windows\W2K3` of the user store (if `%ProfileVer%` is a system environment variable that resolves to `W2K3`).
- `\\server\share\#SAMAccountName#` stores the user settings to the UNC path `\\server\share\<JohnSmith>` (if `#SAMAccountName#` resolves to `JohnSmith` for the current user).

In the path, you can use user environment variables except `%username%` and `%userdomain%`.

If this setting is disabled, the user settings are saved in the current user store.

If this setting is not configured here, the corresponding setting from the .ini file is used.

If this setting is not configured here or in the .ini file, the user settings are saved in the current user store.

Active write back

Files and folders (but not registry entries) that are modified can be synchronized to the user store in the middle of a session, before logoff.

If this policy is not configured here, the value from the .ini file is used. If this policy is not configured here or in the .ini file, it is enabled.

Offline profile support

This policy allows profiles to synchronize with the user store at the earliest possible opportunity. It is aimed at laptop or mobile device users who roam. When a network disconnection occurs, profiles remain intact on the laptop or device even after rebooting or hibernating. As mobile users work, their profiles are updated locally. Also, eventually synchronized with the user store when the network connection is re-established.

If this policy is not configured here, the value from the .ini file is used. If this policy is not configured here or in the .ini file, offline profiles are disabled.

Active write back registry

Use this policy along with “Active write back.” Registry entries that are modified can be synchronized to the user store in the middle of a session.

If you do not configure this setting here, the value from the .ini file is used.

If you do not configure this setting here or in the .ini file, the active write back registry is disabled.

Active write back on session lock and disconnection

With both this policy and the **Active write back** policy enabled, profile files and folders are written back only when a session is locked or disconnected.

With this policy and both the **Active write back** and **Active write back registry** policies enabled, registry entries are written back only when a session is locked or disconnected.

Offline profile support

Enables the offline profiles feature. This feature is intended for computers that are commonly removed from networks. For example, laptops or mobile devices not servers or desktops.

If this setting is not configured here, the value from the .ini file is used.

If this setting is not configured here or in the .ini file, offline profile support is disabled.

Cross-platform policy settings

July 22, 2022

This section contains policy settings relating to configuring the **Profile Management cross-platform** settings feature.

Enable cross-platform settings

By default, to facilitate deployment, cross-platform settings are disabled. Turn on processing by enabling this policy but only after thorough planning and testing of this feature.

If this policy is not configured here, the value from the .ini file is used. If this policy is not configured here or in the .ini file, no cross-platform settings are applied.

Cross-platform settings user groups

Enter one or more Windows user groups. For example, you might use this policy to process only the profiles from a test user group. If this policy is configured, the cross-platform settings feature of Profile Management processes only members of these user groups. If this policy is disabled, the feature processes all users specified by the Processed groups policy.

If this policy is not configured here, the value from the .ini file is used. If this policy is not configured here or in the .ini file, all user groups are processed.

Path to cross-platform definitions

Identifies the network location of the definition files that you copied from the download package. This path must be a UNC path. Users must have read access to this location, and administrators must have write access to it. The location must be a Server Message Block (SMB) or Common Internet File System (CIFS) file share.

If this policy is not configured here, the value from the .ini file is used. If this policy is not configured here or in the .ini file, no cross-platform settings are applied.

Path to cross-platform settings store

Sets the path to the cross-platform settings store, the folder in which users' cross-platform settings are saved. Users must have write access to this area. The path can be an absolute UNC path or a path relative to the home directory.

This area is the common area of the user store where profile data shared by multiple platforms is located. Users must have write access to this area. The path can be an absolute UNC path or a path relative to the home directory. You can use the same variables as for the **Path to user store**.

If this policy is disabled, the path Windows\PM_CP is used. If this policy is not configured here, the value from the .ini file is used. If this policy is not configured here or in the .ini file, the default value is used.

Source for creating cross-platform settings

Specifies a platform as the base platform if this policy is enabled in that platform's OU. This policy migrates data from the base platform's profiles to the cross-platform settings store.

Each platform's own set of profiles are stored in a separate OU. You must decide which platform's profile data to use to seed the cross-platform settings store. It is referred to as the base platform. Consider the cross-platform settings store contains a definition file with no data, or the cached data in a single-platform profile is newer than the definition's data in the store. In this case, the Profile Management migrates the data from the single-platform profile to the store unless you disable this policy.

Important:

If this policy is enabled in multiple OUs, or multiple user or machine objects, the platform that the first user logs on to becomes the base profile.

By default this policy is Enabled.

File system policy settings

July 22, 2022

This section contains policies that set the following:

- Which files in a user profile are synchronized between the system where the profile is installed and the user store
- Which directories in a user profile are synchronized between the system where the profile is installed and the user store

Exclusions policy settings

July 22, 2022

This section describes policy settings for configuring which files and directories in a users profile are excluded from the synchronization process.

Exclusion list - files

List of files that are ignored during synchronization. File names must be paths relative to the user profile (%USERPROFILE%). Wildcards are supported in file names and in folder names, but only wildcards in file names are applied recursively.

Examples:

- `Desktop\Desktop.ini` ignores the file `Desktop.ini` in the `Desktop` folder
- `%USERPROFILE%*.tmp` ignores all files with the extension `.tmp` in the entire profile
- `AppData\Roaming\MyApp*.tmp` ignores all files with the extension `.tmp` in one part of the profile
- `Downloads*\a.txt` ignores `a.txt` in any immediate subfolder of the `Downloads` folder.

If this policy is disabled, no files are excluded. If this policy is not configured here, the value from the .ini file is used. If this policy is not configured here or in the .ini file, no files are excluded.

Enable Default Exclusion List - directories

Default list of directories ignored during synchronization. Use this policy to specify GPO exclusion directories without having to fill them in manually.

If you disable this policy, Profile Management does not exclude any directories by default.

If you do not configure this policy here, Profile Management uses the value from the .ini file. If you do not configure this policy here or in the .ini file, Profile Management does not exclude any directories by default.

Exclusion list - directories

List of folders that are ignored during synchronization. Folder names must be specified as paths relative to the user profile (%USERPROFILE%). Wildcards in folder names are supported but are not applied recursively.

Example:

- **Desktop** ignores the **Desktop** folder in the user profile

If this policy is disabled, no folders are excluded. If this policy is not configured here, the value from the .ini file is used. If this policy is not configured here or in the .ini file, no folders are excluded.

Logon Exclusion Check

This setting configures what Profile Management does if a profile in the user store contains excluded files or folders. The possible policy settings and the corresponding actions are listed in the following table:

| Policy setting | Action |
|--|---|
| Setting is disabled or the value of “Synchronize excluded files or folders on logon” is set to default | Profile Management synchronizes excluded files or folders from the user store to the local profile when a user logs on. |
| Setting is set to “Ignore excluded files or folders on logon” | Profile Management ignores the excluded files or folders in the user store when a user logs on. |
| Setting is set to “Delete excluded files or folder on logon” | Profile Management deletes the excluded files or folders in the user store when a user logs on. |
| Setting is not configured in the Web Studio | The value from the .ini file is used |
| Setting is not configured in the Web Studio or in the .ini file | The excluded files or folders are synchronized from the user store to a local profile when a user logs on. |

Large File Handling - Files to be created as symbolic links

To improve logon performance and to process large-size files, Profile Management creates a symbolic link instead of copying files in this list.

You can use wildcards in policies that refer to files; for example, `!ctx_localappdata!\Microsoft\Outlook*.OST`.

To process the offline folder file (`*.ost`) of Microsoft Outlook, make sure that the **Outlook** folder is not excluded for Profile Management.

Those files cannot be accessed in multiple sessions simultaneously.

Synchronization policy settings

July 22, 2022

The **Synchronization** section describes policy settings for specifying which files and folders in a users profile are synchronized between the system where the profile is installed and the user store.

Directories to synchronize

By default, Profile Management synchronizes the user profile between the system it is installed on and the user store. If you exclude a folder from the synchronization, this policy lets you include the subfolders of the excluded folder back to the synchronization.

Paths on this list must be relative to the user profile. Wildcards in folder names are supported but are not applied recursively.

If this policy is not configured here, the value from the .ini file is used. If this policy is not configured here or in the .ini file, only non-excluded folders in the user profile are synchronized.

Files to synchronize

By default, Profile Management synchronizes the user profile between the system it is installed on and the user store. If you exclude a folder from the synchronization, this policy lets you include the files inside the excluded folder back to the synchronization.

Paths on this list must be relative to the user profile. Wildcards are supported in file names and in folder names, but only wildcards in file names are applied recursively. Wildcards cannot be nested.

Examples:

- `AppData\Local\Microsoft\Office\Access.qat` specifies a file below a folder that is excluded in the default configuration
- `AppData\Local\MyApp*.cfg` specifies all files with the extension `.cfg` in the profile folder `AppData\Local\MyApp` and its subfolders

Disabling this policy has the same effect as enabling it and configuring an empty list.

If this policy is not configured here, the value from the .ini file is used. If this policy is not configured here or in the .ini file, only non-excluded files in the user profile are synchronized.

Folders to mirror

This policy lets you solve issues involving any transactional folder (also known as a referential folder). That folder contains interdependent files, where one file references the other.

Mirroring folders enables Profile Management to process a transactional folder and its contents as a single entity, avoiding profile bloat. For example, you can mirror the **Internet Explorer cookies** folder so that Index.dat is synchronized with the cookies that it indexes. In these situations the “last write wins.” So files in mirrored folders that have been modified in more than one session are overwritten by the last update, resulting in loss of profile changes.

For example, the following table describes how Index.dat references cookies while a user browses the Internet:

| Scenario | How Index.dat references cookies | |
|--|---|---|
| A user has two Internet Explorer sessions, each on a different server, and they visit different sites in each session. User logs off from the first session or in the middle of a session (if the active write back feature is configured) | Cookies from each site are added to the appropriate server.

Cookies from the second session must replace those cookies from the first session. | Cookies from each site are added to the appropriate server. |
| First and second sessions are merged and the references to the cookies in Index.dat become out of date | Further browsing in new sessions results in repeated merging and a bloated cookie folder | |

Mirroring the cookie folder solves the issue. In this case, the cookies are overwritten with those cookies from the last session each time the user logs off. So Index.dat stays up to date.

If this policy is not configured here, the value from the .ini file is used. If this policy is not configured here or in the .ini file, no folders are mirrored.

Accelerate folder mirroring

With both this policy and the **Folders to mirror** policy enabled, **Profile Management stores mirrored** folders on a VHDX-based virtual disk. It attaches the virtual disk during logons and detaches it during logoffs. Enabling this policy eliminates the need to copy the folders between the user store and local profiles and accelerates folder mirroring.

Folder redirection policy settings

July 22, 2022

This section contains policy settings that specify whether to redirect folders that commonly appear in profiles to a shared network location.

Grant administrator access

This setting enables an administrator to access the contents of a user's redirected folders.

Note:

This setting grants permissions to administrators who have complete and unrestricted access to the domain.

By default, this setting is disabled and users are granted exclusive access to the contents of their redirected folders.

Include domain name

This setting enables the inclusion of the `%userdomain%` environment variable as part of the UNC path. This UNC path is specified for redirected folders.

By default, this setting is disabled. And the `%userdomain%` environment variable is not included as part of the UNC path that is specified for redirected folders.

AppData(Roaming) policy settings

February 8, 2023

This section contains policy settings for redirecting the contents of the **AppData(Roaming)** folder to a shared network location.

AppData(Roaming) path

This setting specifies the network location to which the contents of the **AppData(Roaming)** folder are redirected.

By default, this setting is disabled and no location is specified.

If this setting is not configured here, Profile Management does not redirect the specified folder.

Redirection settings for AppData(Roaming)

This setting specifies how to redirect the contents of the **AppData(Roaming)** folder.

By default, contents are redirected to a UNC path. For more information, see the [Path to user store](#) section.

If this setting is not configured here, Profile Management does not redirect the specified folder.

Contacts policy settings

November 3, 2020

This section contains policy settings for redirecting the contents of the **Contacts** folder to a shared network location.

Contacts path

This setting specifies the network location to which the contents of the **Contacts** folder are redirected.

By default, this setting is disabled and no location is specified.

If this setting is not configured here, Profile Management does not redirect the specified folder.

Redirection settings for Contacts

This setting specifies how to redirect the contents of the **Contacts** folder.

By default, contents are redirected to a UNC path.

If this setting is not configured here, Profile Management does not redirect the specified folder.

Desktop policy settings

November 3, 2020

This section contains policy settings for redirecting the contents of the **Desktop** folder to a shared network location.

Desktop path

This setting specifies the network location to which the contents of the **Desktop** folder are redirected.

By default, this setting is disabled and no location is specified.

If this setting is not configured here, Profile Management does not redirect the specified folder.

Redirection settings for Desktop

This setting specifies how to redirect the contents of the **Desktop** folder.

By default, contents are redirected to a UNC path.

If this setting is not configured here, Profile Management does not redirect the specified folder.

Documents policy settings

July 22, 2022

This section contains policy settings for redirecting the contents of the **Documents** folder to a shared network location.

Documents path

This setting specifies the network location to which files in the **Documents** folder are redirected.

By default, this setting is disabled and no location is specified.

If this setting is not configured here, Profile Management does not redirect the specified folder.

The **Documents path** setting must be enabled not only to redirect files to the **Documents** folder, but also to redirect files to the **Music**, **Pictures**, and **Videos** folders.

Redirection settings for Documents

This setting specifies how to redirect the contents of the **Documents** folder.

By default, contents are redirected to a UNC path.

To control how to redirect the contents of the **Documents** folder, choose one of the following options:

- Redirect to the following UNC path. Redirects content to the UNC path specified in the Documents path policy setting.
- Redirect to the users home directory. Redirects content to the users home directory, typically configured as the #homeDirectory# attribute for a user in the Active Directory.

If this setting is not configured here, Profile Management does not redirect the specified folder.

Downloads policy settings

November 3, 2020

This section contains policy settings for redirecting the contents of the **Downloads** folder to a shared network location.

Downloads path

This setting specifies the network location to which files in the **Downloads** folder are redirected.

By default, this setting is disabled and no location is specified.

If this setting is not configured here, Profile Management does not redirect the specified folder.

Redirection settings for Downloads

This setting specifies how to redirect the contents of the **Downloads** folder.

By default, contents are redirected to a UNC path.

If this setting is not configured here, Profile Management does not redirect the specified folder.

Favorites policy settings

November 3, 2020

This section contains policy settings for redirecting the contents of the **Favorites** folder to a shared network location.

Favorites path

This setting specifies the network location to which the contents of the **Favorites** folder are redirected.

By default, this setting is disabled and no location is specified.

If this setting is not configured here, Profile Management does not redirect the specified folder.

Redirection settings for Favorites

This setting specifies how to redirect the contents of the **Favorites** folder.

By default, contents are redirected to a UNC path.

If this setting is not configured here, Profile Management does not redirect the specified folder.

Links policy settings

November 3, 2020

This section contains policy settings for redirecting the contents of the **Links** folder to a shared network location.

Links path

This setting specifies the network location to which the contents of the **Links** folder are redirected.

By default, this setting is disabled and no location is specified.

If this setting is not configured here, Profile Management does not redirect the specified folder.

Redirection settings for Links

This setting specifies how to redirect the contents of the **Links** folder.

By default, contents are redirected to a UNC path.

If this setting is not configured here, Profile Management does not redirect the specified folder.

Music policy settings

November 3, 2020

This section contains policy settings for redirecting the contents of the **Music** folder to a shared network location.

Music path

This setting specifies the network location to which the contents of the **Music** folder are redirected.

By default, this setting is disabled and no location is specified.

If this setting is not configured here, Profile Management does not redirect the specified folder.

Redirection settings for Music

This setting specifies how to redirect the contents of the **Music** folder.

By default, contents are redirected to a UNC path.

To control how to redirect the contents of the **Music** folder, choose one of the following options:

- Redirect to the following UNC path. Redirects content to the UNC path specified in the Music path policy setting.
- Redirect relative to Documents folder. Redirects content to a folder relative to the Documents folder.

To redirect content to a folder relative to the **Documents** folder, the **Documents path** setting must be enabled.

If this setting is not configured here, Profile Management does not redirect the specified folder.

Pictures policy settings

November 3, 2020

This section contains policy settings for redirecting the contents of the **Pictures** folder to a shared network location.

Pictures path

This setting specifies the network location to which the contents of the **Pictures** folder are redirected.

By default, this setting is disabled and no location is specified.

If this setting is not configured here, Profile Management does not redirect the specified folder.

Redirection settings for Pictures

This setting specifies how to redirect the contents of the **Pictures** folder.

By default, contents are redirected to a UNC path.

To control how to redirect the contents of the **Pictures** folder, choose one of the following options:

- Redirect to the following UNC path. Redirects content to the UNC path specified in the Pictures path policy setting.
- Redirect relative to Documents folder. Redirects content to a folder relative to the Documents folder.

To redirect content to a folder relative to the **Documents** folder, the **Documents path** setting must be enabled.

If this setting is not configured here, Profile Management does not redirect the specified folder.

Saved Games policy settings

November 3, 2020

This section contains policy settings for redirecting the contents of the **Saved Games** folder to a shared network location.

Redirection settings for Saved Games

This setting specifies how to redirect the contents of the **Saved Games** folder.

By default, contents are redirected to a UNC path.

If this setting is not configured here, Profile Management does not redirect the specified folder.

Saved Games path

This setting specifies the network location to which the contents of the **Saved Games** folder are redirected.

By default, this setting is disabled and no location is specified.

If this setting is not configured here, Profile Management does not redirect the specified folder.

Start menu policy settings

November 3, 2020

This section contains policy settings for redirecting the contents of the **Start Menu** folder to a shared network location.

Redirection settings for Start Menu

This setting specifies how to redirect the contents of the **Start Menu** folder.

By default, contents are redirected to a UNC path.

If this setting is not configured here, Profile Management does not redirect the specified folder.

Start Menu path

This setting specifies the network location to which the contents of the **Start Menu** folder are redirected.

By default, this setting is disabled and no location is specified.

If this setting is not configured here, Profile Management does not redirect the specified folder.

Searches policy settings

November 3, 2020

This section contains policy settings for redirecting the contents of the **Searches** folder to a shared network location.

Redirection settings for Searches

This setting specifies how to redirect the contents of the **Searches** folder.

By default, contents are redirected to a UNC path.

If this setting is not configured here, Profile Management does not redirect the specified folder.

Searches path

This setting specifies the network location to which the contents of the **Searches** folder are redirected.

By default, this setting is disabled and no location is specified.

If this setting is not configured here, Profile Management does not redirect the specified folder.

Video policy settings

November 3, 2020

This section contains policy settings for redirecting the contents of the **Video** folder to a shared network location.

Redirection settings for Video

This setting specifies how to redirect the contents of the **Video** folder.

By default, contents are redirected to a UNC path.

To control how to redirect the contents of the **Video** folder, choose one of the following options:

- Redirect to the following UNC path. Redirects content to the UNC path specified in the Video path policy setting.
- Redirect relative to Documents folder. Redirects content to a folder relative to the Documents folder.

To redirect content to a folder relative to the **Documents** folder, the **Documents path** setting must be enabled.

If this setting is not configured here, Profile Management does not redirect the specified folder.

Video path

This setting specifies the network location to which the contents of the **Video** folder are redirected.

By default, this setting is disabled and no location is specified.

If this setting is not configured here, Profile Management does not redirect the specified folder.

Log policy settings

March 24, 2023

This section contains policy settings that configure Profile Management logging.

Active Directory actions

This setting enables or disables verbose logging of actions performed in the Active Directory.

By default, this setting is disabled.

When enabling this setting, make sure the **Enable logging** setting is also enabled.

If this setting is not configured in the Web Studio, the value from the .ini file is used.

If this setting is not configured in the Web Studio or in the .ini file, the following is logged:

- Errors
- General information

Common information

This setting enables or disables verbose logging of common information.

By default, this setting is disabled.

When enabling this setting, make sure the **Enable logging** setting is also enabled.

If this setting is not configured here, the value from the .ini file is used.

If this setting is not configured in the Web Studio or in the .ini file, the following is logged:

- Errors
- General information

Common warnings

This setting enables or disables verbose logging of common warnings.

By default, this setting is disabled.

When enabling this setting, make sure the **Enable logging** setting is also enabled.

If this setting is not configured here, the value from the .ini file is used.

If this setting is not configured in the Web Studio or in the .ini file, the following is logged:

- Errors
- General information

Enable logging

This setting enables or disables Profile Management logging in debug (verbose logging) mode. In debug mode, extensive status information is logged in the log files located in “%System-Root%\System32\Logfiles\UserProfileManager”.

By default, this setting is disabled and only errors are logged.

Citrix recommends enabling this setting only if you are troubleshooting Profile Management.

If this setting is not configured here, the value from the .ini file is used.

If this setting is not configured here or in the .ini file, only errors are logged.

File system actions

This setting enables or disables verbose logging of actions performed in the file system.

By default, this setting is disabled.

When enabling this setting, make sure the **Enable logging** setting is also enabled.

If this setting is not configured here, the value from the .ini file is used.

If this setting is not configured in the Web Studio or in the .ini file, the following is logged:

- Errors
- General information

File system notifications

This setting enables or disables verbose logging of file systems notifications.

By default, this setting is disabled.

When enabling this setting, make sure the **Enable logging** setting is also enabled.

If this setting is not configured here, the value from the .ini file is used.

If this setting is not configured in the Web Studio or in the .ini file, the following is logged:

- Errors
- General information

Logoff

This setting enables or disables verbose logging of user logoffs.

By default, this setting is disabled.

When enabling this setting, make sure the **Enable logging** setting is also enabled.

If this setting is not configured here, the value from the .ini file is used.

If this setting is not configured in the Web Studio or in the .ini file, the following is logged:

- Errors
- General information

Logon

This setting enables or disables verbose logging of user logons.

By default, this setting is disabled.

When enabling this setting, make sure the **Enable logging** setting is also enabled.

If this setting is not configured here, the value from the .ini file is used.

If this setting is not configured in the Web Studio or in the .ini file, the following is logged:

- Errors
- General information

Maximum size of the log file

This setting specifies the maximum permitted size for the Profile Management log file, in bytes.

By default, this value is set to 1048576 bytes (1 MB).

Citrix recommends increasing the size of this file to 5 MB or more, if you have sufficient disk space. If the log file grows beyond the maximum size:

- An existing backup of the file (.bak) is deleted
- The log file is renamed to .bak
- A new log file is created

The log file is created in %SystemRoot%\System32\Logfiles\UserProfileManager.

If this setting is not configured here, the value from the .ini file is used.

If this setting is not configured here or in the .ini file, the default value is used.

Path to log file

This setting specifies an alternative path to save the Profile Management log file.

By default, this setting is disabled and log files are saved in the default location: %SystemRoot%\System32\Logfiles\UserProfileManager.

The path can point to a local drive or a remote network-based drive (UNC path). Remote paths can be useful in large distributed environments but they might create significant network traffic, which might be inappropriate for log files. For provisioned, virtual machines with a persistent hard drive, set a local path to that drive. This setting ensures that the log files are preserved when the machine restarts. For virtual machines without a persistent hard drive, setting a UNC path allows you to retain the log files. However, the system account for the machines must have write access to the UNC share. Use a local path for any laptops managed by the offline profiles feature.

If a UNC path is used for log files, Citrix recommends that an appropriate access control list is applied to the log file folder. This setting ensures that only authorized user or computer accounts can access the stored files.

If this setting is not configured here, the value from the .ini file is used.

If this setting is not configured here or in the .ini file, the default location %SystemRoot%\System32\Logfiles\UserPr is used.

Personalized user information

This setting enables or disables verbose logging of personalized user information.

By default, this setting is disabled.

When enabling this setting, make sure the **Enable logging** setting is also enabled.

If this setting is not configured here, the value from the .ini file is used.

If this setting is not configured in the Web Studio or in the .ini file, the following is logged:

- Errors
- General information

Policy values at logon and logoff

This setting enables or disables verbose logging of policy values when a user logs on and off.

By default, this setting is disabled.

When enabling this setting, make sure the **Enable logging** setting is also enabled.

If this setting is not configured here, the value from the .ini file is used.

If this setting is not configured in the Web Studio or in the .ini file, the following is logged:

- Errors
- General information

Registry actions

This setting enables or disables verbose logging of actions performed in the registry.

By default, this setting is disabled.

When enabling this setting, make sure the **Enable logging** setting is also enabled.

If this setting is not configured here, the value from the .ini file is used.

If this setting is not configured in the Web Studio or in the .ini file, the following is logged:

- Errors
- General information

Registry differences at logoff

This setting enables or disables verbose logging of any differences in the registry when a user logs off.

By default, this setting is disabled.

When enabling this setting, make sure the **Enable logging** setting is also enabled.

If this setting is not configured here, the value from the .ini file is used.

If this setting is not configured in the Web Studio or in the .ini file, the following is logged:

- Errors
- General information

Profile handling policy settings

July 23, 2022

This section includes policy settings that specify how Profile Management handles user profiles.

Delay before deleting cached profiles

This setting specifies an optional extension to the delay, in minutes, before Profile Management deletes locally cached profiles at logoff.

A value of 0 deletes the profiles immediately at the end of the logoff process. Profile Management checks for logoffs every minute. As a result, a value of 60 ensures that profiles are deleted between one and two minutes after users log off. This action depends on when the last check occurred. Extending the delay is useful if you know that a process keeps files or the user registry hive open during logoff. With large profiles, this process can also speed up logoff.

By default, this value is set to 0 and Profile Management deletes locally cached profiles immediately.

When enabling this setting, ensure the Delete locally cached profiles on logoff is also enabled.

If this setting is not configured here, the value from the .ini file is used.

If this setting is not configured here or in the .ini file, profiles are deleted immediately.

Delete locally cached profiles on logoff

This setting specifies whether locally cached profiles are deleted after a user logs off.

When this setting is enabled, a user's local profile cache is deleted after they have logged off. Citrix recommends enabling this setting for terminal servers.

By default, this setting is disabled and a user's local profile cache is retained after they log off.

If this setting is not configured here, the value from the .ini file is used.

If this setting is not configured here or in the .ini file, cached profiles are not deleted.

Local profile conflict handling

This setting configures how Profile Management behaves if a user profile exists in both of the following:

- User store

- Local Windows user profile (not a Citrix user profile)

By default, Profile Management uses the local Windows profile, but does not change it in any way.

To control how Profile Management behaves, choose one of the following options:

- Use local profile. Profile Management uses the local profile, but does not change it in any way.
- Delete local profile. Profile Management deletes the local Windows user profile, and then imports the Citrix user profile from the user store.
- Rename local profile. Profile Management renames the local Windows user profile (for backup purposes) and then imports the Citrix user profile from the user store.

If this setting is not configured here, the value from the .ini file is used.

If this setting is not configured here or in the .ini file, existing local profiles are used.

Migration of existing profiles

This setting specifies the types of profile migrated to the user store during logon if a user has no current profile in the user store.

Profile Management can migrate existing profiles “on the fly” during logon if a user has no profile in the user store. After that, the user store profile is used by Profile Management in both of the following:

- Current session
- Any other session configured with the path to the same user store

By default, both local and roaming profiles are migrated to the user store during logon.

To specify the types of profile migrated to the user store during logon, choose one of the following options:

- Local and roaming profiles
- Local
- Roaming
- None (Disabled)

If you select **None**, the system uses the existing Windows mechanism to create profiles, as if in an environment where Profile Management is not installed.

If this setting is not configured here, the value from the .ini file is used.

If this setting is not configured here or in the .ini file, existing local and roaming profiles are migrated.

Automatic migration of existing application profiles

This setting enables or disables the automatic migration of existing application profiles across different operating systems. The application profiles include both the application data in the [AppData](#) folder and the registry entries under `HKEY_CURRENT_USER\SOFTWARE`. This setting can be useful in cases where you want to migrate your application profiles across different operating systems.

For example, suppose you upgrade your operating system (OS) from Windows 10 version 1803 to Windows 10 version 1809. If this setting is enabled, Profile Management automatically migrates the existing application settings to Windows 10 version 1809 the first time each user logs on. As a result, the application data in the [AppData](#) folder and the registry entries under `HKEY_CURRENT_USER\SOFTWARE` are migrated.

If there are multiple existing application profiles, Profile Management performs the migration in the following order of priority:

1. Profiles of the same OS type (single-session OS to single-session OS and multi-session OS to multi-session OS).
2. Profiles of the same Windows OS family; for example, Windows 10 to Windows 10, or Windows Server 2016 to Windows Server 2016).
3. Profiles of an earlier version of the OS; for example, Windows 7 to Windows 10, or Windows Server 2012 to Windows 2016.
4. Profiles of the closest OS.

Note: You must specify the short name of the OS by including the variable “!`CTX_OSNAME!`” in the user store path. Doing so lets Profile Management locate the existing application profiles.

If this setting is not configured here, the setting from the `.ini` file is used.

If this setting is not configured here or in the `.ini` file, it is disabled by default.

Path to the template profile

This setting specifies the path to the profile that you want Profile Management to use as a template to create user profiles.

The specified path must be the full path to the folder containing the `NTUSER.DAT` registry file and any other folders and files required for the template profile.

Note: Do not include `NTUSER.DAT` in the path. For example, with the file `\\myservername\myprofiles\template\ntu` set the location as `\\myservername\myprofiles\template`.

Use absolute paths, which can be either UNC paths or paths on the local machine. Use the latter, for example, to specify a template profile permanently on a Citrix Provisioning Services image. Relative paths are not supported.

Note: This setting does not support expansion of Active Directory attributes, system environment variables, or the %USERNAME% and %USERDOMAIN% variables.

By default, this setting is disabled and new user profiles are created from the default user profile on the device where a user first logs on.

If this setting is not configured here, the value from the .ini file is used.

If this setting is not configured here or in the .ini file, no template is used.

Template profile overrides local profile

This setting enables the template profile to override the local profile when creating user profiles.

Consider that a user has no Citrix user profile, but has a local Windows user profile. In this case, by default the local profile is used and migrated to the user store, if this value is enabled. Enabling this policy setting allows the template profile to override the local profile used when creating user profiles.

If this setting is not configured here, the value from the .ini file is used.

If this setting is not configured here or in the .ini file, no template is used.

Template profile overrides roaming profile

This setting enables the template profile to override a roaming profile when creating user profiles.

Consider that a user has no Citrix user profile, but has a roaming Windows user profile. In this case, by default the roaming profile is used and migrated to the user store, if this value is enabled. Enabling this policy setting allows the template profile to override the roaming profile used when creating user profiles.

If this setting is not configured here, the value from the .ini file is used.

If this setting is not configured here or in the .ini file, no template is used.

Template profile used as a Citrix mandatory profile for all logons

This setting enables Profile Management to use the template profile as the default profile for creating all user profiles.

By default, this setting is disabled and new user profiles are created from the default user profile on the device where a user first logs on.

If this setting is not configured here, the value from the .ini file is used.

If this setting is not configured here or in the .ini file, no template is used.

Registry policy settings

July 23, 2022

This section contains policy settings that specify which registry keys are included or excluded from Profile Management processing.

Exclusion list

List of registry keys in the HKCU hive which are ignored during logoff.

Example: Software\Policies

If this policy is disabled, no registry keys are excluded. If this policy is not configured here, the value from the .ini file is used. If this policy is not configured here or in the .ini file, no registry keys are excluded.

Inclusion list

List of registry keys in the HKCU hive that are processed during logoff.

Example: Software\Adobe.

If this policy is enabled, only keys on this list are processed. If this policy is disabled, the complete HKCU hive is processed. If this policy is not configured here, the value from the .ini file is used. If this policy is not configured here or in the .ini file, all of HKCU is processed.

Enable Default Exclusion List - Profile Management 5.5

Default list of registry keys in the HKCU hive that are not synchronized to the user's profile. Use this policy to specify GPO exclusion files without having to fill them in manually.

If you disable this policy, Profile Management does not exclude any registry keys by default. If you do not configure this policy here, Profile Management uses the value from the .ini file. If you do not configure this policy here or in the .ini file, Profile Management does not exclude any registry keys by default.

NTUSER.DAT backup

Enables a backup of the last known good copy of NTUSER.DAT and rollback in there is corruption.

If you do not configure this policy here, Profile Management uses the value from the .ini file. If you do not configure this policy here or in the .ini file, Profile Management does not back up NTUSER.DAT.

Streamed user profiles policy settings

July 23, 2022

This section contains policy settings that specify how Profile Management processes streamed user profiles.

Always cache

This setting specifies whether Profile Management caches streamed files as soon as possible after a user logs on. Caching files after a user logs on saves network bandwidth, enhancing the user experience.

Use this setting with the **Profile streaming** setting.

By default, this setting is disabled and streamed files aren't cached as soon as possible after a user logs on.

If this setting isn't configured here, the value from the .ini file is used.

If this setting is configured neither here nor in the .ini file, it is disabled.

Always cache size

This setting specifies a lower limit, in MB, on the size of files that are streamed. Profile Management caches any files in this size or larger as soon as possible after a user logs on.

By default, the value is set to 0 (zero) and the cache entire profile feature is used. When the cache entire profile feature is enabled, Profile Management fetches all profile contents in the user store, after a user logs on, as a background task.

If this setting isn't configured here, the value from the .ini file is used.

If this setting is configured neither here nor in the .ini file, it is disabled.

Profile streaming

This setting enables and disables the Citrix streamed user profiles feature. When enabled, profile files and folders are fetched from the user store to the local computer only when users access them after logon. Registry entries and files in the pending area are fetched immediately.

By default, profile streaming is disabled.

If this setting isn't configured here, the value from the .ini file is used.

If this setting is configured neither here nor in the .ini file, it is disabled.

Streamed user profile groups

This setting specifies which user profiles within an OU are streamed, based on Windows user groups.

When enabled, only user profiles within the specified user groups are streamed. All other user profiles are processed normally.

By default, this setting is disabled and all user profiles within an OU are processed normally.

If this setting isn't configured here, the value from the .ini file is used.

If this setting is configured neither here nor in the .ini file, all user profiles are processed.

Enable profile streaming exclusion

When profile streaming exclusion is enabled:

- Profile Management does not stream folders in the exclusion list
- All the folders are fetched immediately from the user store to the local computer when a user logs on

For more information, see [Stream user profiles](#).

Timeout for pending area lock files

This setting specifies the number of days after which users' files are written back to the user store from the pending area, if the user store remains locked when its storage server becomes unresponsive. This behavior prevents bloat in the pending area and ensures that the user store always contains the most up-to-date files.

By default, this setting is set to 1 (one) day.

If this setting isn't configured here, the value from the .ini file is used.

If this setting is configured neither here nor in the .ini file, the default value is used.

Enable profile streaming for pending area

Lets you enable the profile streaming feature for files and folders in the pending area.

The pending area is used to ensure profile consistency while profile streaming is enabled. It temporarily stores profile files and folders changed in concurrent sessions.

By default, this policy is disabled, and all files and folders in the pending area are fetched to the local profile on logon. With this policy enabled, files in the pending area are fetched to the local profile only

when they are requested. Use the policy with the Profile streaming policy to ensure optimal logon experience in concurrent session scenarios.

The policy applies to folders in the pending area when the Enable profile streaming for folders policy is enabled.

User personalization layer policy settings

March 15, 2024

To enable the mounting of user layers within the Virtual Delivery Agents, use the configuration parameters to specify:

- Where on the network to access the user layers.
- How large any new user layer disks can grow.

To do so, these two policies appear in the list of available policies:

- User Layer Repository Path - Enter a path in the format ‘\server name or address\folder name’ in the Value field.
- User Layer Size GB - The default user layer size of 10 GB is the minimum that Citrix recommends. A user layer is a thin-provisioned disk that expands to the set size as space is used. User layers never decrease in size.

Note:

Increasing the User Layer Size affects new user layers and expands existing ones. Decreasing the layer size only affects new user layers. Existing user layers never decrease in size.

For more information, see [User personalization layer](#).

Virtual Delivery Agent policy settings

July 23, 2022

The Virtual Delivery Agent (VDA) section contains policy settings that control communication between the VDA and controllers for a site.

Important: The VDA requires information provided by these settings to register with a Delivery Controller, if you are not using the auto-update feature. Because this information is required for registration, you must configure the following settings using the Group Policy Editor, unless you provide this information during the VDA installation:

- Controller registration IPv6 netmask
- Controller registration port
- Controller SIDs
- Controllers
- Only use IPv6 controller registration
- Site GUID

Controller registration IPv6 netmask

This policy setting allows administrators to restrict the VDA to only a preferred subnet (rather than a global IP, if one is registered). This setting specifies the IPv6 address and network where the VDA register. The VDA register only on the first address that matches the specified netmask. This setting is valid only if the Only use IPv6 controller registration policy setting is enabled.

By default this setting is blank.

Controller registration port

Use this setting only if the **Enable auto update of controllers** setting is disabled.

This setting specifies the TCP/IP port number that the VDA uses to register with a Controller when using registry-based registration.

By default, the port number is set to 80.

Controller SIDs

Use this setting only if the **Enable auto update of controllers** setting is disabled.

This setting specifies a space-separated list of controller Security Identifiers (SIDs) the VDA uses to register with a Controller when using registry-based registration. This setting is an optional and might be used with the **Controllers** setting to restrict the list of Controllers used for registration.

By default, this setting is blank.

Controllers

Use this setting only if the **Enable auto update of controllers** setting is disabled.

This setting specifies a space-separated list of controller Fully Qualified Domain Names (FQDNs) the VDA uses to register with a Controller when using registry-based registration. This setting is an optional and might be used with the **Controller SIDs** setting.

By default, this setting is blank.

Enable auto update of controllers

This setting enables the VDA to register with a Controller automatically after installation.

After the VDA registers, the Controller with which it registered sends a list of the current controller FQDNs and SIDs to the VDA. The VDA writes this list to persistent storage. Each Controller also checks the Site database every 90 minutes for Controller information. The Controller sends updated lists to its registered VDAs if one of the following occurs:

- A Controller has been added or removed since the last check
- A policy change has occurred

The VDA accepts connections from all the Controllers in the most recent list that it received.

By default, this setting is enabled.

Only use IPv6 controller registration

This setting controls which form of address the VDA uses to register with the Controller:

- When enabled, the VDA registers with the Controller using the machine's IPv6 address. When the VDA communicates with the Controller, it uses the following address order: global IP address, Unique Local Address (ULA), link-local address (if no other IPv6 addresses are available).
- When disabled, the VDA registers and communicates with the Controller using the machine's IPv4 address.

By default, this setting is disabled.

Site GUID

Use this setting only if the **Enable auto update of controllers** setting is disabled.

This setting specifies the Globally Unique Identifier (GUID) of the site that the VDA uses to register with a Controller when using Active Directory-based registration.

By default, this setting is blank.

HDX 3D Pro policy settings

July 23, 2022

The HDX 3D Pro section includes policy settings for enabling and configuring the image quality configuration tool for users. This tool enables users to optimize the use of available bandwidth. For this optimization, the balance between image quality and responsiveness is adjusted in real time.

Enable lossless

This setting specifies whether users can enable and disable lossless compression using the image quality configuration tool. By default, users are not given the option to enable lossless compression.

Consider that a user enables lossless compression. In this case, the image quality is automatically set to the maximum value available in the image configuration tool. By default, either GPU or CPU-based compression can be used, according to the capabilities of the user device and the host computer.

HDX 3D Pro quality settings

This setting specifies the minimum and maximum values available to users in the image quality configuration tool. Using these values, users can define the range of image quality adjustment in the image quality configuration tool.

Specify image quality values of between 0 and 100, inclusive. The maximum value must be greater than or equal to the minimum value.

Monitoring policy settings

December 13, 2023

The **Monitoring** section includes policy settings for process, resource monitoring, and application failure monitoring.

The scope of these policies can be defined based on the following:

- Site
- Delivery group
- Type of delivery group
- Organizational unit
- Tags

Policies for process and resource monitoring

Each data point for CPU, memory, and processes is collected from the VDA and stored on the Monitoring database. Sending the data points from the VDA consumes network bandwidth and storing them consumes considerable space in the monitoring database. Consider that you do not want to monitor either resource data or process data or both for a specific scope. For example, a specific delivery group or organizational unit. In this case, it is recommended to disable the policy.

Enable process monitoring

Enable this setting to allow monitoring of processes running on machines with VDAs. Statistics such as CPU and memory use are sent to the Monitoring Service. The statistics are used for real-time notifications and historical reporting in the Director.

The default for this setting is Disabled.

Enable resource monitoring

Enable this setting to allow monitoring of critical performance counters on machines with VDAs. Statistics (such as CPU and memory use, IOPS, and disk latency data) are sent to the Monitoring Service. The statistics are used for real-time notification and historical reporting in the Director.

The default for this setting is Enabled.

Scalability

The CPU and memory data is pushed to the database from each VDA at 5-minute intervals. Process data (if enabled) is pushed to the database at 10-minute intervals. IOPS and disk latency data is pushed to the database at 1-hour intervals.

CPU and memory data

CPU and memory data is **enabled** by default. The data retention values are as follows (Platinum license):

| Data granularity | Number of Days |
|------------------|----------------|
| 5 Minute Data | 1 Day |
| 10 Minute Data | 7 Days |

| Data granularity | Number of Days |
|------------------|----------------|
| Hourly Data | 30 Days |
| Daily Data | 90 Days |

IOPS and disk latency data

IOPS and disk latency data is **Enabled** by default. The data retention values are as follows (Platinum license):

| Data granularity | Number of Days |
|------------------|----------------|
| Hourly Data | 3 Days |
| Daily Data | 90 Days |

With the data retention settings, approximately 276 KB of disk space is required to store the following for one VDA over a period of one year:

- CPU
- Memory
- IOPS
- Disk latency data

| Number of machines | Approximate storage required |
|--------------------|------------------------------|
| 1 | 276 KB |
| 1K | 270 MB |
| 40K | 10.6 GB |

Process data

Process data is **Disabled** by default. It is recommended to enable process data on a subset of machines on a need basis. The default data retention settings for the process data are as follows:

| Data granularity | Number of Days |
|------------------|----------------|
| 10-minute Data | 1 Day |
| Hourly Data | 7 Days |

If process data is enabled with the default retention settings, process data would consume approximately 1.5 MB per VDA and 3 MB per Terminal Services VDA (TS VDA) over a period of one year.

| Number of machines | Approximate storage required VDA | Approximate storage required TS VDA |
|--------------------|----------------------------------|-------------------------------------|
| 1 | 1.5 MB | 3 MB |
| 1K | 1.5 GB | 3 GB |

Note:

The numbers provided earlier do not include the Index space. And all the calculations are approximate and vary depending on the deployment.

Optional Configurations

You can modify the default retention settings to suit your needs. However, this configuration consumes extra storage. By enabling the settings below you can gain more accuracy in the process utilization data. The configurations which can be enabled are:

EnableMinuteLevelGranularityProcessUtilization

EnableDayLevelGranularityProcessUtilization

These Configurations can be enabled from the Monitoring PowerShell cmdlet: [Set-MonitorConfiguration](#)

Policies for application failure monitoring

The **Application Failure** tab, by default, displays only application faults from Multi-session OS VDAs. Settings of Application failure monitoring can be modified with the following Monitoring policies:

Enable monitoring of application failures

Use this setting to configure application failure monitoring to monitor either application errors or faults (crashes and unhandled exceptions), or both.

Disable application failure monitoring by setting the **Value** to **None**.

The default for this setting is Application faults only.

Enable monitoring of application failures on Single-session OS VDAs

By default, failures only from applications hosted on the Multi-session OS VDAs are monitored. To monitor Single-session OS VDAs, set the policy to **Allowed**.

The default for this setting is **Prohibited**.

List of applications excluded from failure monitoring

Specify a list of applications that are not to be monitored for failure.

By default this list is empty.

Policy for collecting data for Analytics

VDA Data Collection for Analytics

Use the policy to enable or disable the Monitor service from collecting performance and security related metrics of the VDAs for Performance and Security Analytics. By default, the policy is **Allowed**.

Set the policy to **Prohibited** to stop the collection of data from the VDAs.

Clipboard place metadata collection for Security monitoring

Use the policy to enable or disable the clipboard place metadata collection by Broker service for Security monitoring, auditing, and compliance. By default, the policy is **Enabled**. Set the policy to **Disabled** to stop the collection of data from the VDAs.

Diagnostic data collection for performance monitoring

Use this policy to enable the monitoring service to gather diagnostic data such as session information, UPM/EUEM service states, Microsoft Teams optimization, and connection protocols. By default, the policy is **Enabled**. Set the policy to **Disabled** to stop the collection of data from the VDAs.

Storage planning tips

Group policy. If you are not interested in monitoring the Resource Data or Process Data, either or both can be turned off using the group policy. For more information, see the **Group Policy** section of [Create policies](#).

Data grooming. The default data retention settings can be modified to groom the data early and free up storage space. For more information on grooming settings, see Data granularity and retention in [Accessing data using the API](#).

Virtual IP policy settings

November 18, 2023

Important:

- Windows 10 Enterprise multi-session doesn't support Remote Desktop IP Virtualization (Virtual IP) and we don't support Remote Desktop IP Virtualization or virtual loopback on Windows 10 Enterprise multi-session.
- Remote Desktop IP Virtualization (Virtual IP) isn't supported on cloud-hosted machines. For more information, see [Microsoft documentation](#).

The **Virtual IP** section includes policy settings that control whether sessions have their own virtual loopback address.

Virtual IP loopback support

When this setting is enabled, each session has its own virtual loopback address. When disabled, sessions do not have individual loopback addresses.

By default, this setting is disabled.

Virtual IP virtual loopback programs list

This setting specifies the application executables that can use virtual loopback addresses. When adding programs to the list, specify only the executable name. You do not need to specify the entire path.

By default, no executables are specified.

Configure COM Port and LPT Port Redirection settings using the registry

March 8, 2023

In VDA versions 7.0 through 7.8, **COM Port and LPT Port** settings are only configurable using the registry. For VDA versions earlier than 7.0 and for VDA versions 7.9 and later, these settings are configurable in Web Studio. For more information, see [Port redirection policy settings](#) and [Bandwidth policy settings](#).

Policy settings for COM Port and LPT Port Redirection are located under HKLM\Software\Citrix\GroupPolicy\Default on the VDA image or machine.

To enable COM port and LPT port redirection, add new registry keys of type REG_DWORD, as follows:

Caution: Editing the registry incorrectly can cause serious problems that might require you to reinstall your operating system. Citrix cannot guarantee that problems resulting from the incorrect use of the Registry Editor can be solved. Use Registry Editor at your own risk. Be sure to back up the registry before you edit it.

| Registry key | Description | Permitted values |
|---------------------------|---|---------------------------------|
| AllowComPortRedirection | Allow or prohibit COM port redirection | 1 (Allow) or 0 (Prohibit) |
| LimitComBw | Bandwidth limit for COM port redirection channel | Numeric value |
| LimitComBWPercent | Bandwidth limit for COM port redirection channel as a percentage of total session bandwidth | Numeric value between 0 and 100 |
| AutoConnectClientComPorts | Automatically connect COM ports from the user device | 1 (Allow) or 0 (Prohibit) |
| AllowLptPortRedirection | Allow or prohibit LPT port redirection | 1 (Allow) or 0 (Prohibit) |
| LimitLptBw | Bandwidth limit for LPT port redirection channel | Numeric value |
| LimitLptBwPercent | Bandwidth limit for LPT port redirection channel as a percentage of total session bandwidth | Numeric value between 0 and 100 |
| AutoConnectClientLptPorts | Automatically connect LPT ports from the user device | 1 (Allow) or 0 (Prohibit) |

After configuring these settings, change your machine catalogs to use the new master image or updated physical machine. Desktops are updated with the new settings that the next time users log off.

Connector for Configuration Manager 2012 policy settings

March 8, 2023

The Connector for Configuration Manager 2012 section contains policy settings for configuring the Citrix Connector 7.5 agent.

Important:

Warning, logoff, and reboot message policies apply only to deployments to Multi-session OS machine catalogs that are managed manually or by Provisioning Services. For those machine catalogs, the Connector service alerts users when there are pending application installs or software updates.

For catalogs managed by MCS, use Web Studio to notify users. For manually managed Single-session OS catalogs, use the Configuration Manager to notify users. For Single-session OS catalogs managed by Provisioning Services, use Provisioning Services to notify users.

Warning frequency interval

This setting defines the interval between appearances of the warning message to users.

Intervals are set using the format ddd.hh:mm:ss, where:

- ddd is days, an optional parameter, with a range of 0–999.
- hh is hours with a range of 0–23.
- mm is minutes with a range of 0–59.
- ss is seconds with a range of 0–59.

By default, the interval setting is 1 hour (01:00:00).

Warning message box body text

This setting contains the editable text of the message to users notifying them of upcoming software updates or maintenance that requires them to log off.

By default, the message is: {TIMESTAMP} Save your work. The server goes offline for maintenance in {TIMELEFT}.

Warning message box title

This setting contains the editable text of the title bar of the warning message to users.

By default, the title is: Upcoming Maintenance

Warning time period

This setting defines how far before maintenance the warning message first appears.

The time is set using the format ddd.hh:mm:ss, where:

- ddd is days, an optional parameter, with a range of 0–999.
- hh is hours with a range of 0–23.
- mm is minutes with a range of 0–59.
- ss is seconds with a range of 0–59.

By default, the setting is 16 hours (16:00:00), indicating that the first warning message appears approximately 16 hours before maintenance.

Final force logoff message box body text

This setting contains the editable text of the message-alerting users that a forced logoff has begun.

By default, the message is: The server is currently going offline for maintenance

Final force logoff message box title

This setting contains the editable text of the title bar of the final force-logoff message.

By default, the title is: Notification From IT Staff

Force logoff grace period

This setting defines the period between notifying users to log off and the implementation of the forced logoff to process the pending maintenance.

The time is set using the format ddd.hh:mm:ss, where:

- ddd is days, an optional parameter, with a range of 0–999.
- hh is hours with a range of 0–23.
- mm is minutes with a range of 0–59.
- ss is seconds with a range of 0–59.

By default, the force-logoff grace period setting is 5 minutes (00:05:00).

Force logoff message box body text

This setting contains the editable text of the message-telling users to save their work and log off before starting a forced logoff.

By default, the message contains the following: {TIMESTAMP} Save your work and log off. The server goes offline for maintenance in {TIMELEFT}.

Force logoff message box title

This setting contains the editable text of the title bar of the force-logoff message.

By default, the title is: Notification From IT Staff

Image-managed mode

The Connector agent automatically detects if it is running on a machine clone managed by Provisioning Services or MCS. The agent blocks Configuration Manager updates on image-managed clones and automatically installs the updates on the master image of the catalog.

After a master image is updated, use WEb Studio to orchestrate the reboot of MCS catalog clones. The Connector Agent automatically orchestrates the reboot of PVS catalog clones during Configuration Manager maintenance windows. To override this behavior so that software is installed on catalog clones by Configuration Manager, change Image-managed mode to Disabled.

Reboot message box body text

This setting contains the editable text of the message-notifying users when the server is about to be restarted.

By default, the message is: The server is currently going offline for maintenance.

Regular time interval at which the agent task is to run

This setting determines how frequently the Citrix Connector agent task runs.

The time is set using the format ddd.hh:mm:ss, where:

- ddd is days, an optional parameter, with a range of 0–999.
- hh is hours with a range of 0–23.
- mm is minutes with a range of 0–59.
- ss is seconds with a range of 0–59.

By default, the regular time interval setting is 5 minutes (00:05:00).

Manage

June 3, 2020

Managing a Citrix Virtual Apps and Desktops site covers various items and tasks.

Licensing

A valid connection to the Citrix License Server is required when you create a site. Later, you can complete several licensing tasks from Studio, including adding licenses, changing license types or models, and managing license administrators. You can also access the License Administration Console from Studio.

Applications

Manage applications in Delivery Groups and optionally, Application Groups.

Zones

In a geographically disperse deployment, you can use zones to keep applications and desktops closer to end users, which can improve performance. When you install and configure a site, all Controllers, machine catalogs, and host connections are in one primary zone. Later, you can use Studio to create satellite zones containing those items. After your site has more than one zone, you will be able to indicate in which zone any newly created machine catalogs, host connections, or added Controllers will be placed. You can also move items between zones.

Connections and resources

If you are using a hypervisor or other service to host machines that deliver applications and desktops to users, you create your first connection to that hypervisor or other service when you create a site. The storage and network details for that connection form its resources. Later, you can change that connection and its resources, and create more connections. You can also manage the machines that use a configured connection.

Local Host Cache

Local Host Cache allows connection brokering operations in a site to continue when the connection between a Delivery Controller and the site database fails.

Virtual IP and virtual loopback

The Microsoft virtual IP address feature provides a published application with a unique dynamically assigned IP address for each session. The Citrix virtual loopback feature allows you to configure applications that depend on communications with localhost to use a unique virtual loopback address in the localhost range.

Delivery Controllers

This article contains considerations and procedures when adding and removing Controllers from a site. It also describes how to move Controllers to another zone or site, and how to move a VDA to another site.

VDA registration with Controllers

Before a VDA can help deliver applications and desktops, it must register (establish communication) with a Controller. Controller addresses can be specified in several ways, which are described in this article. It is critical that VDAs have current information as Controllers are added, moved, and removed in the site.

Sessions

Maintaining session activity is critical to providing the best user experience. Several features can optimize the reliability of sessions, reduce inconvenience, downtime, and loss of productivity.

- Session reliability
- Auto Client Reconnect
- ICA Keep-Alive
- Workspace control
- Session roaming

Use search in Studio

When you want to view information about machines, sessions, machine catalogs, applications, or Delivery Groups in Studio, use the flexible search feature.

Tags

Use tags to identify items such as machines, applications, groups, and policies. You can then tailor certain operations to apply on to items with a specific tag.

IPv4/IPv6

Citrix Virtual Apps and Desktops supports pure IPv4, pure IPv6, and dual-stack deployments that use overlapping IPv4 and IPv6 networks. This article describes and illustrates these deployments. It also describes the Citrix policy settings that control the use of IPv4 or IPv6.

User profiles

By default, Citrix Profile Management is installed automatically when you install a VDA. If you use this profile solution, review this article for general information. See the [Profile Management](#) documentation for details.

Collect Citrix Diagnostic Facility (CDF) traces

The CDFControl utility is an event tracing controller or consumer for capturing Citrix Diagnostic Facility (CDF) trace messages displayed from various Citrix tracing providers. It is made to troubleshoot complex Citrix related issues, parse filter support, and collect performance data.

Citrix Insight Services

Citrix Insight Services (CIS) is a Citrix platform for instrumentation, telemetry, and business insight generation.

Citrix Scout

Citrix Scout collects diagnostics and runs health checks. You can use the results for proactive maintenance in your Citrix Virtual Apps and Desktops deployment. Citrix offers comprehensive, automated analysis of diagnostics collections through Citrix Insight Services. You can also use Scout to troubleshoot issues, on your own or with Citrix Support guidance.

Applications

June 9, 2023

Note:

You can manage your Citrix Virtual Apps and Desktops deployment using two management consoles: Web Studio (web-based) and Citrix Studio (Windows-based). This article covers only Web Studio. For information about Citrix Studio, see the equivalent article in Citrix Virtual Apps and Desktops 7 2212 or earlier.

Introduction

If your deployment uses only delivery groups (and not application groups), you add applications to the delivery groups. If you also have application groups, generally you add applications to the application groups instead. This guidance provides easier administration. An application must always belong to at least one delivery group or application group.

In the Add Applications wizard, you can select one or more delivery groups, or one or more application groups, but not both. Although you can later change an application's group association (for example, moving an application from an application group to a delivery group), best practice discourages adding that complexity. Keep your applications in one type of group.

When you associate an application with more than one group, a visibility issue can occur if you do not have sufficient permission to view the application in all of those groups. In such cases, either consult an administrator with greater permissions or have your scope extended to include all the groups with which the application is associated.

If you publish two applications with the same name (perhaps from different groups) to the same users, change the **Application name (for user)** property in Web Studio. Otherwise, users see duplicate names in Citrix Workspace app.

You can change an application's properties (settings) when you add it, or later. You can also change the application folder where the application is placed, either when you add the application, or later.

For details, see:

- [Create delivery groups](#)
- [Create application groups](#)
- [Tags](#)

Add applications

You can add applications when you create a delivery group or application group. Those procedures are detailed in [Create delivery groups](#) and [Create application groups](#). The following procedure describes how to add applications after you create a group.

Good to know:

- You cannot add applications to Remote PC Access delivery groups.
- You cannot use the Add Application wizard to remove applications from delivery groups or application groups. That is a separate operation.

To add one or more applications:

1. Select **Applications** in the left pane and then select **Add Applications** in the action bar.
2. The Add Applications wizard launches with an **Introduction** page, which you can remove from future launches of this wizard.
3. The wizard guides you through the **Groups**, **Applications**, and **Summary** pages. When you are done with each page, click **Next** until you reach the **Summary** page.

Alternatives to step 1 if you want to add applications to a single delivery group or application group:

- **To add applications to only one delivery group:** In step 1, select **Delivery Groups** in the Web Studio left pane, select a delivery group in the middle pane, and then select **Add Applications** in the action bar. The wizard does not display the **Groups** page.
- **To add applications to only one application group:** In step 1, select **Applications** in the Web Studio left pane, select an application group in the middle pane, and then select the **Add Applications** entry under the application group's name in the action bar. The wizard does not display the **Groups** page.

Groups page

This page lists all the delivery groups in the site. If you have also created application groups, the page lists the application groups and delivery groups. You can choose from either group, but not from both

groups. In other words, you cannot add applications to an application group and a delivery group at the same time. Generally, if you are using application groups, add applications to application groups, rather than delivery groups.

When adding an application, select the check box next to at least one delivery group (or application group, if available). Every application must always be associated with at least one group.

Applications page

Click **Add** to display the application sources.

- **From Start menu:** Applications that are discovered on a machine in the selected delivery groups. When you select this source, a new page launches with a list of discovered applications. Select the check boxes of applications to add, and then click **OK**.

This source cannot be selected if you (1) selected application groups with no associated delivery groups, (2) selected application groups with associated delivery groups that contain no machines, or (3) selected a delivery group containing no machines.

- **Manually:** Applications located on a VDA in the delivery group or elsewhere in your network. Selecting this source opens a new page where you specify an application to add in the following ways:
 - Type the path to the executable, working directory, optional command line arguments, and display names for administrators and users.
 - Select an application from a VDA in the delivery group. To do so, click **Browse**, enter credentials for accessing the VDA, wait to be connected to the VDA, and then select an application from the VDA. The properties of the selected application automatically populate fields on the page.
- **Existing:** Applications previously added to the site. When you select this source, a new page launches with a list of discovered applications. Select the check boxes of applications to add and then click **OK**.

This source cannot be selected if the site has no applications.

- **App-V:** Applications in App-V packages. When you select this source, a new page launches where you select the App-V server or the Application Library. From the resulting display, select the check boxes of applications to add, and then click **OK**. For more information, see [Deploy and deliver App-V applications](#).

This source cannot be selected if App-V is not configured for the site.

- **Application Group:** Application groups. When you select this source, a new page launches with a list of application groups. (Although the display also lists the applications in each group, you

can select only the group, not individual applications.) All current and future applications in the selected groups are added. Select the check boxes of application groups to add, and then click **OK**.

This source cannot be selected if (1) there are no application groups, or (2) if the selected delivery groups do not support application groups (for example, delivery groups with statically assigned machines).

As noted in the table, some sources in the **Add** list cannot be selected if there is no valid source of that type. Sources that are incompatible (for example, you cannot add application groups to application groups) are not included in the list. Applications that are already added to the groups you chose cannot be selected.

You can change an application's properties (settings) from this page, or later.

By default, added applications are placed in the application folder named **Applications**. You can change the application from this page, or later. If you try to add an application and one with the same name exists in the same folder, you are prompted to rename the application you're adding. You can accept the new name offered, or decline and then rename the application or select a different folder. For example, if **app** already exists in the **Applications** folder, and you attempt to add another application named **app** to that folder, the new name **app_1** is offered.

Summary page

If you are adding 10 or fewer applications, their names are listed in **Applications to add**. If you are adding more than 10 applications, the total number is specified.

Review the summary information and then click **Finish**.

Change an application's group association

After adding an application, you can change the delivery groups and application groups with which the application is associated.

You can drag an application to an additional group. This is an alternative to using commands in the action bar.

If an application is associated with more than one delivery or application group, group priority can be used to specify the order in which multiple groups are checked to find applications. By default, all groups are priority 0 (the highest). Groups at the same priority are load balanced.

An application can be associated with delivery groups containing shared (not private) machines that can deliver applications. You can also select delivery groups containing shared machines that deliver

desktops only, if (1) the delivery group contains shared machines and was created with a XenDesktop 7.x version earlier than 7.9, and (2) you have **Edit delivery group** permission. The delivery group type is automatically converted to **desktops and applications** when the properties dialog is committed.

1. Sign in to Web Studio, select **Applications** in the left pane, and then select the application.
2. Select **Properties** in the action bar.
3. Select the **Groups** page.
 - To add a group, click **Add** and select **Application Groups** or **Delivery Groups**. (If you have not created any application groups, the only entry is **Delivery Groups**.) Then select one or more available groups. Groups that are incompatible with the application, or that are already associated with the application, cannot be selected.
 - To remove a group, select one or more groups and then click **Remove**. If removing group association would result in the application no longer being associated with any group, you are alerted that the application will be deleted.
 - To change the priority of a group, select the group and then click **Edit Priority**. Select a priority value and then click **OK**.
4. When you are finished, click **Apply** to apply the changes and leave the window open, or click **OK** to apply the changes and close the window.

Duplicate, enable or disable, rename, or delete an application

The following actions are available:

- **Duplicate:** You might want to duplicate an application to create a different version with different parameters or properties. When you duplicate an application, it is automatically renamed with a unique suffix and placed next to the original. You might also want to duplicate an application and then add it to a different group. (After duplicating, the easiest way to move an application is dragging it.)
- **Enable or disable:** Enabling and disabling an application is a different action than enabling and disabling a delivery group or application group.
- **Rename:** You can rename only one application at a time. If you try to rename an application and one with the same name exists in the same folder or group, you are prompted to specify a different name.
- **Delete:** Deleting an application removes it from the delivery groups and application groups with which it was associated, but not from the source that was used to add the application originally. Deleting an application is a different action than removing it from a delivery group or application group.

To duplicate, enable, disable, rename, or delete an application:

1. Select **Applications** in the left pane.
2. Select one or more applications in the middle pane and then select the appropriate task in the action bar.
3. Confirm the action, when prompted.

Remove applications from a delivery group

An application must be associated (belong) with at least one delivery group or application group. If you attempt to remove an application from a delivery group that would remove that application's association with any delivery group or application group, you are notified that the application will be deleted if you continue. When that happens, if you want to deliver that application, you must add it again from a valid source.

1. Select **Delivery Groups** in the left pane.
2. Select a delivery group. In the lower middle pane, on the **Applications** tab, select the application you want to remove.
3. Select **Remove Application** from the action bar.
4. Confirm the removal.

Remove applications from an application group

An application must belong to at least one delivery group or application group. If you attempt to remove an application from an application group that will result in that application no longer belonging to any group, you are notified that the application will be deleted if you continue. When that happens, if you want to deliver that application, you must add it again from a valid source.

1. Select **Applications** in the left pane.
2. Select the application group in the middle pane, and then select one or more applications.
3. Select **Remove from Application Group** in the action bar.
4. Confirm the removal.

Change application properties

You can change the properties of only one application at a time.

To change the properties of an application:

1. Select **Applications** in the left pane.
2. Select an application and then select **Edit Application Properties** in the action bar.
3. Select the page containing the property you want to change.

4. When you are finished, click **Apply** to apply any changes you made and keep the window open, or click **OK** to apply changes and close the window.

In the following list, the page is shown in parentheses.

| Property | Page |
|---|-----------------------|
| Category/folder where application appears in Citrix Workspace app | Delivery |
| Command line arguments; see Pass parameters to published applications | Location |
| Delivery groups and application groups where the application is available | Groups |
| Description | Identification |
| File name extensions and file type association: which extensions the application opens automatically | File Type Association |
| Icon | Delivery |
| Keywords for StoreFront | Identification |
| Limits; see Configure application limits | Delivery |
| Name: Names seen by the user and by the administrator | Identification |
| Path to executable; see Pass parameters to published applications | Location |
| Shortcut on user's desktop: enable or disable | Delivery |
| Visibility: Limits which users can see the application in Citrix Workspace app. An invisible application can still be started. To make it unavailable and invisible, add it to a different group. | Limit Visibility |
| Working directory | Location |

Application changes might not take effect for current application users until they log off from their sessions.

Configure application limits

Configure application limits to help manage application use. For example, you can use application limits to manage the number of users accessing an application simultaneously. Similarly, application limits can be used to manage the number of simultaneous instances of resource-intensive applications. That limit can help maintain server performance and prevent deterioration in service.

This feature limits the number of application launches that are brokered by the Controller (for example, from Citrix Workspace app and StoreFront), and not the number of running applications that can be launched by other methods. This means that application limits assist administrators when managing concurrent usage, but do not provide enforcement in all scenarios. For example, application limits cannot be applied when the Controller is in outage mode.

By default, there is no limit on how many application instances can run at the same time. There are several application limit settings. You can configure any or all of them.

- The maximum number of concurrent instances of the application by all users in the delivery group.
- One instance of the application per user in the delivery group.
- The maximum number of concurrent instances of the application per machine (PowerShell only).

If a limit is configured, an error message is generated when a user attempts to launch an instance of the application that will exceed the configured limit. If more than one limit is configured, an error is reported when the first limit is reached.

Examples using application limits:

- **Maximum number of simultaneous instances limit:** In a delivery group, you configure the maximum number of simultaneous instances of application *Alpha* to 15. Later, users in that delivery group have 15 instances of that application running at the same time. If any user in that delivery group now attempts to launch *Alpha*, an error message is generated. *Alpha* is not launched because it would exceed the configured simultaneous application instance limit (15).
- **One-instance-per-user application limit:** In another delivery group, you enable the one-instance-per-user option for application *Beta*. User Tony launches application *Beta* successfully. Later in the day, while that application is still running in Tony's session, he attempts to launch another instance of *Beta*. An error message is generated and *Beta* is not launched because it would exceed the one-instance-per-user limit.
- **Maximum number of simultaneous instances and one-instance-per-user limits:** In another delivery group, you configure a maximum number of simultaneous instances of 10 and enable the one-instance-per-user option for application *Delta*. Later, when 10 users in that delivery

group each have an instance of **Delta** running, any other user in that delivery group who tries to launch **Delta** will receive an error message. **Delta** is not launched. If any of the 10 current **Delta** users attempt to launch a second instance of that application, they will receive an error message and the second instance will not be launched.

- **Maximum number of simultaneous instances per machine, and using tag restrictions:** Application **Charlie** has licensing and performance requirements that dictate how many instances can be running at the same time on a specific server. Those requirements also dictate how many instances can be running simultaneously across all servers in the site.

The application instances-per-machine limit affects any server in the site (not just machines in a particular delivery group). Let's say your site has three servers. For application **Charlie**, you configure the app instances per machine limit to 2. So, no more than six instances of application **Charlie** are allowed to launch site-wide. (That's a limit of two instances of **Charlie** on each of the three servers.)

To restrict an application's usage to only certain machines within a delivery group (in addition to limiting the instances on all machines site-wide):

- Use the tagging functionality for those machines.
- Configure the maximum number of instances per machine limit for that application.

If applications are launched by methods other than Controller brokering (for example, while a Controller is in outage mode) and configured limits are exceeded, users cannot launch more instances until they close enough instances to no longer exceed the limits. The instances that exceeded the limit are not forcibly shut down. They will be allowed to continue until their users close them.

If you disable session roaming, then disable the one-instance-per-user application limit. If you enable the one-instance-per-user application limit, do not configure either of the two values that allow new sessions on new devices. For information about roaming, see [Sessions](#).

To configure the maximum instances per delivery group limit, and the one-instance-per-user limit:

1. Select **Applications** in the left pane and then select an application.
2. Select the **Edit Application Properties** in the action bar.
3. On the **Delivery** page, choose one of the following options.
 - **Allow unlimited use of the application.** There is no limit to the number of instances running at the same time. This is the default.
 - **Set limits for the application.** There are two limit types; specify either or both.
 - Specify the maximum number of instances that can run concurrently per machine
 - Limit to one instance of the application per user
4. Click **OK** to apply the change and close the dialog box, or **Apply** to apply the change and leave the dialog box open.

To configure the maximum instances per machine limit (PowerShell only):

- In PowerShell (using the Remote PowerShell SDK for Citrix Cloud deployments, or the PowerShell SDK for on-premises deployments), enter the appropriate `BrokerApplication` cmdlet with the `MaxPerMachineInstances` parameter.
- For guidance, use the `Get-Help` cmdlet. For example:

```
Get-Help Set-BrokerApplication -Parameter MaxPerMachineInstances
```

Pass parameters to published applications

Use the **Location** page of an application's properties to enter the command line and pass parameters to published applications.

When you associate a published application with file types, the symbols "%*" (percent and star symbols enclosed in double quotation marks) are appended to the end of the command line for the application. These symbols act as a placeholder for parameters passed to user devices.

If a published application does not launch when expected, verify that its command line contains the correct symbols. By default, parameters supplied by user devices are validated when the symbols "%*" are appended. For published applications that use customized parameters supplied by the user device, the symbols "%**" are appended to the command line to bypass command-line validation. If you do not see these symbols in a command line for the application, add them manually.

If the path to the executable file includes directory names with spaces (such as "C:\Program Files"), enclose the command line for the application in double quotation marks to indicate that the space belongs in the command line. To do this, add double quotation marks around the path, and another set of double quotation marks around the %* symbols. Be sure to include a space between the closing quotation mark for the path and the opening quotation mark for the %* symbols.

For example, the command line for the published application Windows Media Player is:

```
"C:\Program Files\Windows Media Player\mplayer1.exe""%*"
```

Note:

The maximum number of characters, including arguments, in the command line for launching published applications is 203.

Manage application folders

By default, new applications you add to delivery groups are placed in a folder named **Applications**. You can specify a different folder when you create the delivery group, when you add an application, or later.

Good to know:

- You cannot rename or delete the Applications folder, but you can move all the applications it contains to other folders you create.
- A folder name can contain 1–64 characters. Spaces are permitted.
- Folders can be nested up to five levels.
- Folders do not have to contain applications. Empty folders are allowed.
- Folders are listed alphabetically in Web Studio unless you move them or specify a different location when you create them.
- You can have more than one folder with the same name, as long as each has a different parent folder. Similarly, you can have more than one application with the same name, as long as each is in a different folder.
- You must have [View Applications](#) permission to see the applications in folders, and you must have [Edit Application Properties](#) permission for all applications in the folder to remove, rename, or delete a folder that contains applications.
- Most of the following procedures request actions using the action bar in Web Studio. Alternatively, you can use right-click menus or drag the item. For example, if you create or move a folder in a location you did not intend, you can drag/drop it to the correct location.

To manage application folders, select **Applications** in the left pane. Use the following list for guidance.

- **To view all folders (excluding nested folders):** Click **Show all** above the folder list.
- **To create a folder at the highest level (not nested):** Select the **Applications** folder. To place the new folder under an existing folder other than **Applications**, select that folder. Then, select **Create Folder** in the actions bar. Enter a name.
- **To move a folder:** Select the folder and then select **Move Folder** in the action bar. You can move only one folder at a time unless the folder contains nested folders. (The easiest way to move a folder is to drag it.)
- **To rename a folder:** Select the folder, and then select **Rename Folder** in the action bar. Enter a name.
- **To delete a folder:** Select the folder, and then select **Delete Folder** in the action bar. When you delete a folder that contains applications and other folders, those objects are also deleted. Deleting an application removes the application assignment from the delivery group. It does not remove it from the machine.
- **To move applications into a folder:** Select one or more applications. Then, select **Move Application** in the action bar. Select the folder.

You can also place applications you are adding in a folder on the **Application** page when creating a delivery group or an application group. By default, added applications go in the **Applications** folder. Click **Change** to select or create a folder.

Control local launch of applications on published desktops

When users launch a published application from within a published desktop, you can control whether the application is launched in that desktop session or as a published application. Citrix Workspace app searches for the installation path of the application in the Windows registry on the VDA and, if present, launches the local instance of the application. Otherwise, a hosted instance of the application is launched. If you launch an application that is not installed on the VDA, the hosted application is launched. For more information, see [vPrefer launch](#).

In PowerShell (using the Remote PowerShell SDK in Citrix Cloud deployments or the PowerShell SDK in on-premises deployments), you can change this action.

In the `New-BrokerApplication` or `Set-BrokerApplication` cmdlet, use the `LocalLaunchDisabled` option. For example:

```
Set-BrokerApplication -LocalLaunchDisabled <Boolean>
```

By default, this option's value is false (`-LocalLaunchDisabled $false`). When launching a published application from within a published desktop, the application is launched in that desktop session.

If you set the option's value to true (`-LocalLaunchDisabled $true`), the published application is launched. This creates a separate, additional session from the published desktop (using Citrix Workspace app for Windows) to the published application.

Requirements and limits:

- The application's `ApplicationType` value must be `HostedOnDesktop`.
- This option is available only through the appropriate PowerShell SDK. It is not currently available in the Web Studio graphical interface.
- This option requires minimum: StoreFront 3.14, Citrix Receiver for Windows 4.11, and Delivery Controller 7.17.

App packages

November 16, 2023

Note:

You can manage your Citrix Virtual Apps and Desktops deployment using two management consoles: Web Studio (web-based) and Citrix Studio (Windows-based). This article covers only Web

Studio. For information about Citrix Studio, see the equivalent article in Citrix Virtual Apps and Desktops 7 2212 or earlier.

Microsoft provides three packaging technologies to deliver applications to users: App-V, MSIX, and MSIX app attach. This article walks you through how to deploy and deliver these packaged applications using **Web Studio > App Packages**:

- Deploy and deliver App-V applications
- Deploy and deliver MSIX and MSIX app attach applications

Deploy and deliver App-V applications

This section covers the following information:

- Overview. Describes the management methods for delivering and managing the App-V packages.
- Procedures. Provides procedures for deploying and delivering these packages.

Overview

This section describes the management methods for delivering and managing the App-V packages. For more information about the components and concepts with which you interact when delivering App-V packaged applications, see the Microsoft documentation: <https://docs.microsoft.com/en-us/windows/application-management/app-v/appv-for-windows>.

You can use the following methods to deliver and manage App-V packages:

- **Dual Admin.** Application packages are configured and managed on App-V servers. Citrix Virtual Apps and Desktops and App-V servers work together to deliver and manage packages.

This method requires Citrix Virtual Apps and Desktops to periodically refresh the snapshot view of the App-V server's state. It incurs hardware, infrastructure, and administration overhead. Citrix Virtual Apps and Desktops and App-V servers must stay synchronized, particularly for user permissions.

Dual Admin works best in deployments where App-V and your environment are closely coupled:

- **App-V management server.** Publishes and manages the lifecycle of App-V Packages and the [Dynamic Configuration Files](#).
- **Citrix Personalization component** installed on VDA machines. Manage the registration of the appropriate App-V publishing server required for application launches.

This method ensures that the App-V publishing server is synchronized for the user at the appropriate time. The publishing server maintains other aspects of the package life cycle, such as refresh on logon and connection groups.

- **Single Admin.** Application packages are stored on network shares. Citrix Virtual Apps and Desktops delivers and manages packages independently.

This method reduces overhead because the App-V servers and database infrastructure aren't needed in the deployment.

In this method, you store App-V packages on a network share and upload their metadata from that location to your environment. The Citrix Personalization component installed on VDA machines then manages and delivers applications as follows:

- Process the Deployment Configuration Files and User Configuration Files when an application is launched.
- Manage all aspects of the life cycles for packages on the host machine.

You can use both management methods simultaneously. In other words, when you add applications to delivery groups, the applications can come from App-V packages present on App-V servers or on network shares.

Note:

If you're using both management methods simultaneously and the App-V package has a Dynamic Configuration File in both locations, the file on the App-V server (Dual Admin) is used.

Procedures

To support the delivery of App-V applications, you must install the Citrix Personalization component on VDA machines. See [Install the Citrix Personalization component on VDA machines](#) for details.

To deliver App-V packaged applications to your users, follow these steps:

1. Store application packages on network shares.
2. Upload application packages into your environment.
3. Add applications to delivery groups.
4. To enable automatic delivery of interdependent App-V packages, create isolation groups.

To have Citrix Virtual Apps and Desktops recognize and apply App-V Dynamic Configuration Files in the Single Admin method, see this [Citrix blog](#).

Deploy and deliver MSIX and MSIX app attach applications

This section covers the following information:

- Overview. Describes how the MSIX and MSIX app attach packages are delivered and managed.
- Procedures. Provides procedures for deploying and delivering these packages.

Overview

Citrix Virtual Apps and Desktops delivers MSIX and MSIX app attach applications to users through the Citrix Personalization component installed on VDA machines. This component manages all aspects of the life cycles for packages on the host machine.

For more information about MSIX and MSIX app attach, see the Microsoft documentation: <https://docs.microsoft.com/en-us/windows/msix/> and <https://docs.microsoft.com/en-us/azure/virtual-desktop/what-is-app-attach> respectively.

Procedures

To support the delivery of MSIX and MSIX app attach packages, you must install the Citrix Personalization component on VDA machines. See [Install the Citrix Personalization component on VDA machines](#) for details.

To deliver MSIX and MSIX app attach packaged applications to your users, follow these steps:

1. Store application packages on network shares.
2. Upload application packages into your environment.
3. Add applications to delivery groups.

Install the Citrix Personalization component on VDA machines

The Citrix Personalization component manages the publishing process for application packages in App-V, MSIX, and MSIX app attach formats. This component isn't installed by default when you install a VDA. You can install the component during or after VDA installation.

To install the component during VDA installation, use either of the following ways:

- In the installation wizard, go to the **Additional Components** page and then select the **Citrix Personalization for App-V - VDA** check box.
- In the command line interface, use the `/includeadditional "Citrix Personalization for App-V -VDA"` option.

To install the component after VDA installation, follow these steps:

1. On the VDA machine, go to **Control Panel > Programs > Programs and Features**, right-click **Citrix Virtual Delivery Agent**, and then select **Change**.

2. In the wizard that appears, proceed to the **Additional Components** page and then enable the **Citrix Personalization for App-V - VDA** check box.

Note:

Microsoft App-V Desktop Client is the component that runs virtual applications from App-V packages on user devices. Windows 10 (1607 or later), Windows Server 2016, and Windows Server 2019 already include this App-V client software. You only need to enable it on VDA machines. For more information, see this Microsoft documentation article: <https://docs.microsoft.com/en-us/windows/application-management/app-v/appv-enable-the-app-v-desktop-client>.

Store application packages on network shares

After you set up the infrastructure, generate the application packages and store them in a network location, such as a UNC or SMB network share, or on an Azure File Share.

Detailed steps are as follows:

1. Generate application packages. See the Microsoft documentation for details.
2. Store application packages in a network location:
 - For **App-V Single Admin**: Store the packages and the corresponding Dynamic Configuration Files (App-V) on a UNC or SMB network share or on an Azure File Share.
 - For **App-V Dual Admin**: Publish the packages onto the App-V management server from a UNC path. (Publishing from HTTP URLs isn't supported.)
 - For **MSIX or MSIX app attach**: Store the packages on a UNC or SMB network share or on an Azure File Share.
3. Make sure that the VDA has read permission on the package storage path:
 - If you store packages on a UNC or SMB network share in your AD domain, grant the VDA machine read permission to the storage path. To do so, you can give the machine's AD account read permission to the share explicitly, or include the account in an AD group that has that permission.
 - If you store packages on an Azure File Share, first grant a user account read permission to the storage path in Azure. Next, configure `ctxAppVService` running on the VDA machine to use that user account to access the package storage path. See the following section for detailed steps.

Change the user logon account

The VDA calls `ctxAppVService` to access package storage paths. By default, `ctxAppVService` accesses package storage paths using the machine's **Local System account**. This type of machine authentication works in AD domains. However, it doesn't work in the AD and Azure AD integration scenarios, which require user account-based authentication.

If you store packages on an Azure File Share, change the logon account for `ctxAppVService` to a user account that has read permission on the package storage path. Detailed steps are as follows:

1. Start **Services**, right-click **ctxAppVService**, and then select **Properties**.
2. On the **Log on** tab, select **This account**, enter a user account that has read permission to the package storage path, and then enter the user's password twice.
3. Click **OK**.

Upload application packages into your environment

After you store application packages to a network location as needed, upload them to your environment for delivery. Use either of the following methods as needed:

- Upload in bulk
- Upload one by one

Preparations

Citrix Virtual Apps and Desktops uses a VDA machine to set up the connection to the network location for package discovery. Therefore, [create a delivery group](#) beforehand and make sure that at least one VDA in the group meets the following requirements:

- VDA version:
 - To discover App-V packages: 2203 or later
 - To discover MSIX and MSIX app attach packages: 2209 or later
- Citrix Personalization for App-V component: Installed
- Permission on the package location: Read (See Step 2: Store application packages on network shares for details.)
- Power: On
- State: Registered

Upload application packages in bulk

Upload packages in a network location to your environment. Make sure that you have the following items ready before the upload:

- A delivery group that meets the Preparation requirements
- The network location path

To upload packages in bulk, follow these steps:

1. In the left pane, select **App Packages**.
2. On the **Sources** tab, click the **Add Source** button. The **Add Source** page appears.
3. In the **Name** field, enter a descriptive name for the package source.
4. In the **Delivery group** field, click **Select a delivery group**. Next, select a delivery group that meets the requirements stated in Preparation and then click **OK**.
5. In the **Location type** field, select **Microsoft App-V server** or **Network share** based on where you store the packages, and then complete the corresponding settings:
 - If you select **Microsoft App-V server**, enter the following information:
 - URL of the Management server. Example: `http://appv-server.example.com`
 - Login credentials of the management server administrator.
 - URL and port number of the publishing server. Example: `http://appv-server.example.com:3330`
 - If you selected **Network share**, specify the following information:
 - Enter the UNC path of the network share. Example: `\\Package-Server\apps\`
 - Select the package types that you want to upload. Options include App-V, MSIX, and MSIX app attach.
 - Specify whether to search subfolders for packages.
6. Click **Add Source**.

The Add Source page closes and the newly added source appears in the source list. Citrix Virtual Apps and Desktops uploads the packages to your environment using a VDA in the delivery group. After the upload completes, the Status field shows *Import successful*. The corresponding packages appear on the **Packages** tab.

Note:

To check for package updates in a source location and import them to your environment, select the location in the source list and click **Check for Package Updates**.

Upload application packages one by one

Upload an application package from a network share to your environment. Before the upload, make sure that you have the following items ready:

- A delivery group that meets the requirements stated in Preparation
- The network location path.

To upload a package to your environment, follow these steps:

1. In the left pane, select **App Packages**.
2. On the **Packages** tab, click the **Add Package** button. The **Add Package** page appears.
3. In the **Delivery group** field, click **Select a delivery group**. Next, select a delivery group that meets the requirements stated in Preparation, and then click **OK**.
4. In the **Package full path** field, enter a path as needed:
 - To upload several packages at a time, enter their full paths, separated by semicolons (;). Example: `\\Package-Server\apps\office365.appv; \\Package-Server\apps\skype.msix; \\Package-Server\apps\slack.vhd`
 - To upload all packages present on a network share, enter the storage path. Example: `\package-Server\apps\`
5. Click **Add Package**.

The application package appears on the **Packages** tab.

Add applications to delivery groups

After an application package is fully uploaded, add its applications to one or more delivery groups as needed. As a result, users associated with those delivery groups can access the applications.

To add one or more applications in a package to several delivery groups, follow these steps:

1. In the left pane, select **App Packages**.
2. On the **Packages** tab, select a package as needed.
3. In the action bar, click **Add Delivery Groups**. The Add Delivery Groups page appears.
4. Select one or more applications in the package as needed, and then click **Next**. Delivery groups with the *Applications* delivery type appear.
5. In the delivery groups list, select the groups to which you want to assign the applications, and then click **Next**.

Note: If you selected an MSIX or MSIX app attach package, only delivery groups whose functional level is 2106 or later are shown in the list.

6. Click **Finish**.

You can also add packaged applications to a delivery group when:

- Creating a delivery group. For more information, see [Create delivery groups](#).
- Editing existing delivery groups or application groups. For more information, see [Add applications](#).

(Optional) Create isolation groups for App-V packages

You can create isolation groups to enable the automatic delivery of interdependent App-V packages.

Note:

Isolation groups are supported for the App-V Single Admin method. If you're using the App-V Dual Admin method, you can achieve the same goal by creating *connection groups* in the Microsoft App-V infrastructure. For more information, see this Microsoft documentation article: <https://docs.microsoft.com/en-us/windows/application-management/app-v/appv-connection-group-file>.

About isolation groups

An isolation group is a collection of interdependent application packages that must run in the same Windows Sandbox to create a virtual environment. Citrix App-V isolation groups are similar but not identical to App-V connection groups. An isolation group includes two types of packages:

- **Explicit** application packages. Applications with specific licensing requirements. You can restrict those applications to a specific range of users by adding them to delivery groups.
- **Automatic** application packages. Applications that are always available to all users regardless of whether they are added to delivery groups.

For example, the application `app-a` requires JRE 1.7 to run. You can create an isolation group that contains `app-a` (marked as *Explicit*) and JRE 1.7 (marked as *Automatic*). Next, add the App-V package for `app-a` to one or more delivery groups. When a user launches `app-a`, JRE 1.7 is automatically deployed with it.

When a user starts an App-V application marked as *Explicit* in an isolation group, Citrix Virtual Apps and Desktops checks the user's access permission to the application in delivery groups. If the user has permission to access the application, any *Automatic* application packages in the same isolation group are made available to the user.

You do not need to add the *Automatic* packages to any delivery group. If there's another *Explicit* application package in the isolation group, that package is made available to the user only if it is in the same delivery group.

For more information about isolated groups, see this [Citrix blog](#).

Create an App-V isolation group Create an isolation group and add interdependent application packages to it. Detailed steps are as follows:

1. On the **Isolation Groups** tab, click **Add Isolation Group**.
2. Enter a name and description for the isolation group. All application packages in your environment appear in the **Available Packages** list.
3. From the **Available Packages** list, select an application as needed, and then click the right arrow. The selected application appears in the **Packages in Isolation Group** list.
4. In the **Deployment** field, select **Explicit** or **Automatic** for the application.
5. Repeat steps 2–3 to add more packages.
6. To adjust the order of packages in the list, click the up or down arrow.
7. Click **Save**.

Note:

Isolation Group configurations result in the creation of an App-V Connection Groups on the VDA. Deployment scenarios can become complex and the App-V client supports packages that are only in one active Connection Group at a time. We recommend that you avoid adding the same package to two different isolation groups that are added to the same delivery group.

Publish packaged applications on single-session or shared desktop VDAs

You can now deliver App-V, MSIX, and MSIX app attach packages to your single-session or shared desktop VDA sessions directly through delivery groups. You can access the packaged applications on your desktop VDA at sign in based on the accessibility permissions set on the applications.

Benefits

- Applications available on the VDA at sign in and not staged on demand through Workspace or StoreFront.
- Improved launch time when accessing the packaged applications.
- Facilitates maintenance of the packaged applications independently, separate from the VDA's base image.

Considerations

- This option is available for single-session VDAs only through the appropriate PowerShell SDK. It is not currently available in the Web Studio workflow. Publishing to shared desktops can be done with the PowerShell SDK or in the existing way through the Web Studio workflow. For more information on the existing procedure, see [Add applications to delivery groups](#).
- Applications must be part of a delivery group.

Before you begin

- Ensure that the packaged applications are signed and are available at the fileshare or UNC location. For more information, see [Store application packages on network shares](#).
- Install the [Citrix Personalization component on VDA machines](#).

Procedure

To deliver packaged applications to desktop VDAs, follow these steps:

1. Import application packages to Web Studio.
2. Publish the packaged BrokerApplication.
3. Limit the visibility of applications on the Web Studio.

Import application packages to Web Studio

1. Open a web browser. Enter `https://<address of the server hosting Web Studio>/Citrix/Studio`.
2. Create a delivery group. For more information, see [Create delivery groups](#).
3. Import the application packages to Web Studio. For more information, see [Upload application packages in bulk](#).

Publish the packaged application on BrokerApplication

If you are publishing to a multi-session (shared) VDA or to a single-session application VDA, then the publishing procedure is unchanged. For more information, see [Add applications to delivery groups](#).

If you are publishing to a single-session desktop VDA, do the following:

On the Delivery Controller, run the following PowerShell commands:

1. To retrieve the commands present in the package:

```
Import-Module "D:\Support\Tools\Scripts\Citrix.Cloud.AppLibrary.  
Admin.v1.psm1"
```

Note:

The version of the [App-V package discovery module](#) that supports this functionality can be found on the Citrix Virtual Apps and Desktops ISO (2311 or higher versions) on the path above.

2. To retrieve the relevant delivery group IDs and packaged application IDs:

```
Get-BrokerDesktopGroup | Format-Table Uid, Name  
Get-AppLibAppVApplication | Format-Table Uid, Name
```

3. To publish the packages and create the appropriate BrokerMachineConfigurations:

```
Publish-PackagedApplication -AppLibraryApplicationUid <AppLibraryApplication.Uid> -DesktopGroupUid <DesktopGroup.Uid>
```

4. To synchronize the Broker configurations, which are later sent out to the Broker agent on VDA:

```
Update-DesktopGroupMachineConfigurations -DesktopGroupUid <DesktopGroup.Uid>
```

Note:

Ensure to run the PowerShell command `Update-DesktopGroupMachineConfigurations` after you publish or remove packaged applications from a VDA.

Limit the visibility of applications on Web Studio

By default, users have all the packaged applications assigned to the delivery group serving their VDA available on their desktop session. You can control the visibility of packaged applications on the desktop VDAs by setting the visibility of applications to specific users or groups on the Web Studio. To manage the visibility of packaged applications, see [Change Application Properties](#).

Universal Windows Platform Apps

January 5, 2023

For information about Universal Windows Platform (UWP) apps, see the following Microsoft documentation:

- [What's a Universal Windows Platform \(UWP\) app?](#)
- [Windows Package Manager](#)

Requirements and limitations

Citrix Virtual Apps and Desktops supports the use of UWP apps with VDAs on the following Windows machines:

- Windows 10 and later versions
- Windows Server 2016 and later versions

VDAs must be minimum version 7.11.

The following Citrix Virtual Apps and Desktops features are either not supported or limited when using UWP apps:

- File type association is not supported.
- Local App Access is not supported.
- Dynamic preview: If apps running in the session overlap, the preview shows the default icon. The Win32 APIs used for Dynamic Preview are not supported in UWP apps.
- Action Center remoting: UWP apps can use the Action Center for displaying the messages in the session. These messages are currently not redirected to the endpoint to be displayed to the user.

Launching UWP apps and non-UWP apps from the same server is not supported. Instead, place UWP apps and non-UWP apps in separate delivery groups or application groups.

Because all UWP apps installed on the machine are enumerated, Citrix recommends disabling user access to the Windows Store. This precludes the UWP apps installed by one user from being accessed by a different user.

During sideloading, the UWP app is installed on the machine and is available for use by other users. When another user launches the app, then it is installed, and the OS updates its AppX database to indicate “as installed” by that user.

A graceful logoff started from a published UWP app that was launched in a fixed or seamless window might prevent the VDA session from closing and forcibly log off the user. When this occurs, several processes remaining in the VDA session prevent it from properly closing. To resolve this, determine which process is preventing the VDA session from closing, and then add it to the “LogoffCheckSysModules” registry key value, following the guidance in [CTX891671](#).

Application Display Names and Descriptions for UWP apps might not have correct names. Edit and correct these properties when adding the applications to the delivery group.

Check [Known issues](#) for any additional issues.

Currently, several UWP apps have white icons with transparency enabled, which results in the icon not being visible against the white background of the StoreFront display. To avoid this issue, you can change the background. For example, on the StoreFront machine, edit the file

`C:\inetpub\wwwroot\Citrix\StoreWeb\custom\style.css`. At the end of the file, add `.storeapp-icon { background-image: radial-gradient(circle at top right, yellow, red); }`. The following graphic illustrates the before-and-after for this example.

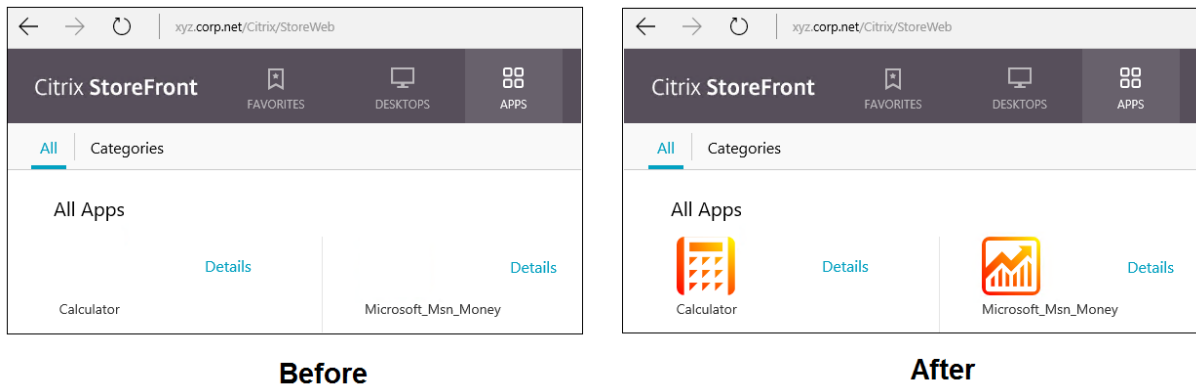

On Windows Server 2016 and later versions, the Server Manager might also launch when a UWP app is launched. To prevent this from occurring, you can disable Server Manager from auto-starting during logon with the `HKLM\Software\Microsoft\ServerManager\DoNotOpenServerManagerAtLogon` registry key. For details, see <https://blogs.technet.microsoft.com/rmilne/2014/05/30/how-to-hide-server-manager-at-logon/>.

Install and publish UWP apps

Support for UWP apps is enabled by default.

To install one or more UWP apps on VDAs (or a master image), use one of the following methods:

- Complete an offline install from the Windows Store for Business, using a tool such as Deployment Image Servicing and Management (DISM) to deploy the apps to the desktop image. For more information, see [Windows Package Manager](#).
- Sideload the apps. For more information, see [Sideload line of business \(LOB\) apps in Windows client devices](#).
- Install the UWP apps for each intended user directly from the Windows Store for Business.

To add (publish) one or more UWP apps in Citrix Virtual Apps or Citrix Virtual Desktops:

1. After the UWP apps are installed on the machine, add the UWP apps to a delivery group or application group. You can do this when you create a group, or later. On the **Applications** page, in the **Add** menu, select **From Start menu**.
2. When the applications list appears, select the UWP apps you want to publish.
3. Continue with the wizard or close the edit dialog.

To disable the use of Universal Apps on a VDA, add the registry setting **EnableUWASeamlessSupport** in `HKLM\Software\Citrix\VirtualDesktopAgent\FeatureToggle` and set to **0**.

Uninstall UWP apps

When you uninstall a UWP app with a command such as `Remove-AppXPackage`, the item is uninstalled only for administrators. To remove the app from the machines of users who may have launched and used the app, run the removal command on each machine. You cannot uninstall the AppX package from all users' machines with one command.

Autoscale

November 9, 2023

Autoscale is a feature that provides a consistent, high-performance solution to proactively power manage your machines. It aims to balance costs and user experience.

Autoscale enables proactive power management of all registered single-session and multi-session OS machines in a delivery group.

Autoscale features include:

- [Schedule-based and load-based settings](#)
- [Dynamic session timeouts](#)
- [Autoscale tagged machines \(cloud burst\)](#)
- [User logoff notifications](#)

Supported VDA hosting platforms

Autoscale supports all the platforms that Citrix Virtual Apps and Desktops supports. This includes various infrastructure platforms including XenServer, Amazon Web Services, Google Cloud Platform, Microsoft Azure Resource Manager, VMware vSphere, and many more. For a complete list of supported platforms, see [System requirements](#) for Citrix Virtual Apps and Desktops.

Note:

When adding public cloud host connections to your deployment, you need Hybrid Rights License. For information about Hybrid Rights License, see [Transition and Trade-Up \(TTU\) with Hybrid Rights](#). For information about adding a license, see [Create a site](#).

Supported workloads

Autoscale supports both multi-session OS and single-session OS delivery groups. There are three user interfaces to be aware of:

- Autoscale user interface for multi-session OS delivery groups (formerly RDS delivery groups)
- Autoscale user interface for single-session OS random (pooled) delivery groups (formerly pooled VDI delivery groups)
- Autoscale user interface for single-session OS static delivery groups (formerly static VDI delivery groups)

For more information about the user interfaces for different delivery groups, see [Autoscale user interfaces](#).

Benefits

The Autoscale feature delivers the following benefits:

- Provide you with a single, consistent mechanism to power manage machines in a delivery group.
- Ensure availability and control costs by powering machines with load-based or schedule-based power management, or a combination of both.
- To monitor metrics such as cost savings and capacity utilization, and to enable notifications, use [Director](#).

Watch a 2-minute video

The following video provides a quick tour of Autoscale.

[This is an embedded video. Click the link to watch the video](#)

Getting started with Autoscale

May 10, 2023

Autoscale works at a delivery group level. It proactively power manages machines in a delivery group based on the schedules that you set.

Autoscale applies to all types of delivery groups:

- Single-session static OS
- Single-session random OS
- Multi-session random OS

This article describes basic Autoscale-related concepts and provides guidance on how to enable and configure Autoscale for a delivery group.

Basic concepts

Before you start, learn about the following basic concepts in Autoscale:

- Schedules
- Capacity buffer
- Load index

Schedules

Autoscale powers on and off machines in a delivery group based on a schedule that you set.

A schedule includes the number of active machines for each time slot, with peak and off-peak times defined.

Schedule settings vary with the type of delivery group. For more information, see:

- [Multi-session OS delivery groups](#)
- [Single-session OS random delivery groups](#)
- [Single-session OS static delivery groups](#)

Capacity buffer

Capacity buffer is used to add spare capacity to the current demand to account for dynamic load increases. There are two scenarios to be aware of:

- For multi-session OS delivery groups, the capacity buffer is defined as a percentage of the total capacity of the delivery group in terms of load index.
- For single-session OS delivery groups, the capacity buffer is defined as a percentage of the total number of machines in the delivery group.

Load index

IMPORTANT:

Load index applies only to multi-session delivery groups.

The load index metric determines how likely a machine is to receive user logon requests. It's calculated using the **Citrix Load Management policy** settings configured for concurrent logon, session, CPU, disk, and memory use.

The load index ranges from 0 to 10,000. By default, a machine is considered at full load when it's hosting 250 sessions:

- The digit “0” indicates an unloaded machine. A machine with a load index value of 0 is at a baseline load.
- The digit “10,000” indicates a fully loaded machine that can't run any more sessions.

Enable Autoscale for a delivery group

Autoscale is disabled by default when you create a delivery group. To enable and configure Autoscale for a delivery group using Web Studio, follow these steps:

You can also use PowerShell commands to enable and configure Autoscale for a delivery group. For more information, see [Broker PowerShell SDK commands](#).

1. Select **Delivery Groups** in the left pane.
2. Select the delivery group that you want to manage and then click **Manage Autoscale**.

The screenshot shows the Citrix Web Studio interface. On the left is a navigation pane with 'Delivery Groups' selected. The main area displays a table of delivery groups. The 'Manage Autoscale' button is highlighted with a red box. Below is a table of delivery groups:

| Delivery Group | Delivering | Machine Count | Session in Use |
|---|---|-----------------------------|-----------------------------|
| appGroup
Multi-session OS | Applications | Total: 2
Unregistered: 2 | Total: 0
Disconnected: 0 |
| JianS W2K19 Desktop
Multi-session OS | Applications and Desktops | Total: 1
Unregistered: 0 | Total: 0
Disconnected: 0 |
| JianS Win10 Random
Single-session OS | Desktops | Total: 2
Unregistered: 2 | Total: 1
Disconnected: 0 |
| JianS Win10 Static Dedicated
Single-session OS Managed by Citrix Cloud | Desktops
(Static machine assignment) | Total: 2
Unregistered: 1 | Total: 1
Disconnected: 1 |
| sinWSVDA
Single-session OS | -
(Static machine assignment) | Total: 1
Unregistered: 1 | Total: 1
Disconnected: 1 |
| WSVDAGROUP
Single-session OS | Desktops
(Static machine assignment) | Total: 2
Unregistered: 2 | Total: 2
Disconnected: 2 |
| YanAppGroup
Multi-session OS Managed by Citrix Cloud | Applications and Desktops | Total: 1
Unregistered: 1 | Total: 0
Disconnected: 0 |

3. On the **Manage Autoscale** page, select the **Enable Autoscale** check box to enable Autoscale. After you enable Autoscale, the options on the page are enabled.

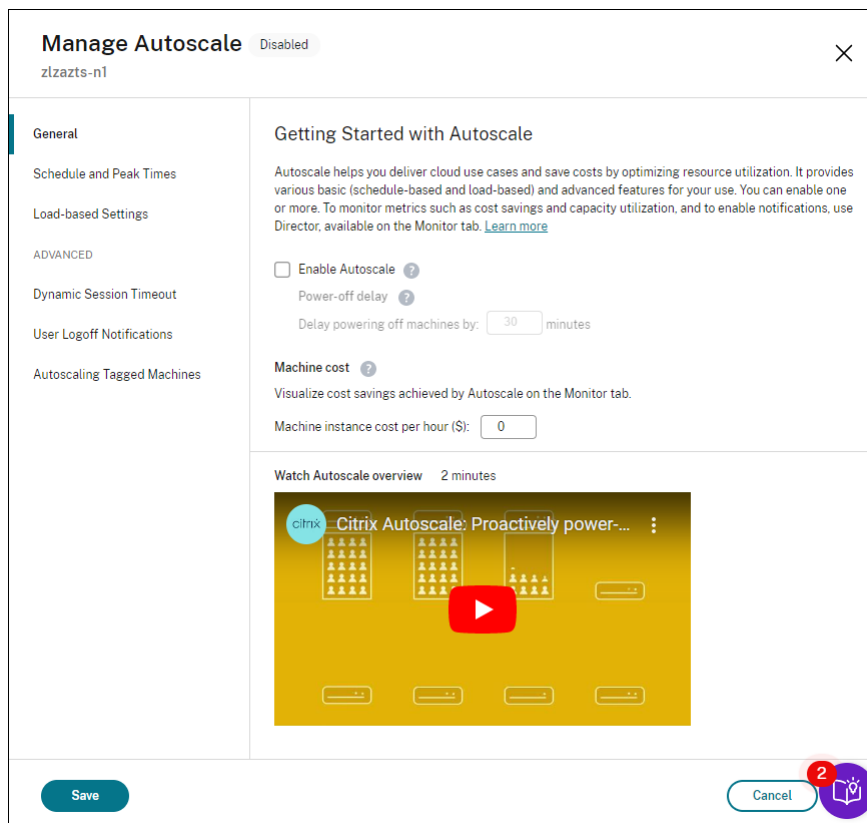

4. To change the default settings based on your organization’s needs, complete the following settings:

- [Set up schedules](#)
- To power off inactive machines more efficiently, use [Dynamic session timeouts](#) and [User logoff notifications](#)
- To power manage a subset of machines in the delivery group, use [Autoscaling tagged machines](#)

To disable Autoscale, clear the **Autoscale** check box. The options on the page turn gray to indicate that Autoscale is disabled for the selected delivery group.

Important:

- If you disable Autoscale, all machines managed by Autoscale remain in their states at the time of disabling.
- After you disable Autoscale, the machines in drain state are taken out of drain state. For more information about drain state, see [Drain state](#).

Monitor metrics

After you enable Autoscale for a delivery group, you can monitor the following metrics of Autoscale-managed machines from Director.

- Machine usage
- Estimated savings
- Alert notifications for machines and sessions
- Machine status
- Load evaluation trends

Note:

When you initially enable Autoscale for a delivery group, it might take a few minutes to display monitoring data for that delivery group.

Monitoring data remains available if Autoscale is enabled and then disabled for the delivery group. Autoscale collects monitoring data at 5-minute intervals.

For more information about the metrics, see [Monitor Autoscale-managed machines](#).

Good to know

Autoscale works at a delivery group level. It's configured on a per-delivery group basis. It power manages only the machines in the selected delivery group.

Capacity and machine registration

Autoscale includes only machines that are registered with the site when determining the capacity. Powered-on machines that are unregistered can't accept session requests. As a result, they aren't included in the overall capacity of the delivery group.

Scaling across multiple machine catalogs

In some sites, multiple machine catalogs might be associated with a single delivery group. Autoscale randomly powers on machines from each catalog to meet schedule or session demand requirements.

For example, a delivery group has two machine catalogs: Catalog A has three machines powered on and Catalog B has one machine powered on. If Autoscale needs to power on an extra machine, it might power on a machine from either Catalog A or Catalog B.

Machine provisioning and session demand

The machine catalog associated with the delivery group must have enough machines to power on and off as demand increases and decreases. If session demand exceeds the total number of registered machines in the delivery group, Autoscale ensures that all registered machines are powered on. However, **Autoscale does not provision additional machines.**

Instance size considerations

You can optimize your costs if you appropriately size your instances in public clouds. We recommend that you provision smaller instances as long as they match your workload performance and capacity requirements.

Smaller instances host fewer user sessions than larger instances. Therefore, Autoscale puts machines into drain state much faster because it takes less time for the last user session to be logged off. As a result, Autoscale powers off smaller instances sooner, thereby reducing costs.

Drain state

Autoscale attempts to scale down the number of powered-on machines in the delivery group to the configured pool size and capacity buffer.

To achieve this goal, Autoscale puts the excess machines with the fewest sessions into “drain state” and powers them off when all sessions are logged off. This behavior occurs when session demand lessens and the schedule requires fewer machines than are powered on.

Autoscale puts excess machines into “drain state” one by one:

- If two or more machines have the same number of active sessions, Autoscale drains the machine that has been powered on for the specified power-off delay.
Doing so avoids putting recently powered-on machines into drain state because those machines are more likely to have the fewest sessions.
- If two or more machines have been powered on for the specified power-off delay, Autoscale drains those machines one by one at random.

Machines in drain state no longer host new session launches and are waiting for the existing sessions to be logged off. A machine becomes a candidate for shutdown only when all sessions are logged off. However, if there are no machines immediately available for session launches, Autoscale prefers directing the session launches to a machine in drain state over powering on a machine.

A machine is taken out of drain state when one of the following conditions is met:

- The machine is powered off.

- Autoscale is disabled for the delivery group to which the machine belongs.
- Autoscale uses the machine to meet schedule or load demand requirements. This case occurs when the schedule (schedule-based scaling) or the current demand (load-based scaling) requires more machines than the number of machines that are currently powered on.

Important:

If no machines are immediately available for session launches, Autoscale prefers directing session launches to a machine in drain state over powering on a machine. A machine in drain state that hosts a session launch remains in drain state.

To find out which machines are in drain state, use the `Get-BrokerMachine` PowerShell command. For example: `Get-BrokerMachine -DrainingUntilShutdown $true`. Alternatively, you can use the Manage console. See [Display machines in drain state](#).

Display machines in drain state

Note:

This feature applies only to multi-session machines.

In Web Studio, you can display machines that are in drain state, letting you know which machines are about to shut down. Complete the following steps:

1. Navigate to the **Search** node and then click **Columns to Display**.
2. In the **Columns to Display** window, select the check box next to **Drain State**.
3. Click **Save** to exit the **Columns to Display** window.

The **Drain State** column can display the following information:

- **Draining until shutdown.** Appears when machines are in drain state until they’re shut down.
- **Not draining.** Appears when machines aren’t yet in drain state.

| Name ↓ | Machine Catalog | Delivery Group | Maintenance Mode | User Change Per... | Power State | Registration State | Sessio... | Drain State |
|--------------------|-----------------|----------------|------------------|--------------------|-------------|--------------------|-----------|-------------------------|
| 318zjh001.xd.local | zjh-mul | zjh-mul | Off | Discard | On | Registered | - | Draining until shutdown |
| 318zjh002.xd.local | zjh-mul | zjh-mul | Off | Discard | On | Registered | 1 | Not draining |
| 318zjh003.xd.local | zjh-mul | zjh-mul | Off | Discard | On | Registered | 1 | Not draining |

More information

For more information on Autoscale, see [Citrix Autoscale](#) in Tech Zone.

Schedule-based and load-based settings

May 9, 2023

How Autoscale power manages machines

Autoscale powers machines on and off based on the selected schedule. Autoscale lets you set multiple schedules that include specific days of the week and adjust the number of machines available during those times. If you expect a set of users to consume the machine resources at a specific time on specific days, Autoscale helps provide an optimized experience. Note that those machines will be powered on during the schedule, whether or not there are sessions running on them.

Note:

Autoscale supports any power-managed machine.

The schedule is based on the **time zone** of the delivery group. To change the time zone, you can change user settings in a delivery group. For more information, see [Manage Delivery Groups](#).

Autoscale has two default schedules: *Weekdays* (Monday through Friday) and *Weekend* (Saturday and Sunday). By default, the **Weekdays** schedule keeps one machine powered on from 07:00 AM to 06:30 PM during peak times and none during off-peak times. The default capacity buffer is set to 10% during peak and off-peak times. By default, the **Weekend** schedule keeps no machines powered on.

Note:

Autoscale treats only those machines that are registered with the site as part of the available capacity in the calculations it makes. “Registered” means that the machine is available for use or already in use. Doing so ensures that only machines that can accept user sessions are included in the capacity for the delivery group.

User interfaces

There are three types of user interfaces to be aware of.

User interface for *single-session OS static delivery groups*:

Manage Autoscale Enabled

- General
- Schedule and Peak Ti...**
- Load-based Settings

ADVANCED

Restrict Autoscale

Schedule and Peak Times

If you expect a set of users to consume the machine resources at a specific time on specific days, use Autoscale to set multiple schedules that include specific days of the week. You can then adjust the number of machines available during those times. Designate peak usage times for optimized behavior and to control other settings such as capacity buffer under Load-based Settings. [Learn more](#)

[Set schedules](#)

Weekdays

Days applied: Mon Tue Wed Thu Fri Sat Sun

Peak times

12:00 AM 3:00 AM 6:00 AM 9:00 AM 12:00 PM 3:00 PM 6:00 PM 9:00 PM 12:00 AM

Weekend

[Save](#) [Cancel](#) [Apply](#)

Manage Autoscale Enabled

General

Schedule and Peak Ti...

Load-based Settings

ADVANCED

Restrict Autoscale

Load-based Settings

Capacity buffer is used to accommodate sudden spikes in demand by keeping a buffer of machines powered on based on the maximum load index of the delivery group. By default, the capacity buffer is 10% of the maximum supported load index of the delivery group. A lesser value decreases the cost. A greater value ensures an optimized user experience so that users do not have to wait for additional machines to power on when launching sessions. [Learn more](#)

| | During peak times | During off-peak times |
|------------------------------|--|---|
| Capacity buffer (%): | <input type="text" value="10"/> | <input type="text" value="10"/> |
| When disconnected (minutes): | <input type="text" value="0"/> <input data-bbox="858 622 1050 656" type="text" value="No action"/> | <input type="text" value="0"/> <input data-bbox="1201 622 1393 656" type="text" value="No action"/> |
| When logged off (minutes): | <input type="text" value="0"/> <input data-bbox="858 678 1050 712" type="text" value="No action"/> | <input type="text" value="0"/> <input data-bbox="1201 678 1393 712" type="text" value="No action"/> |

Autoscale user interface for *single-session OS random delivery groups*:

Manage Autoscale Enabled

General

Schedule and Peak Ti...

Load-based Settings

ADVANCED

Restrict Autoscale

Schedule and Peak Times

If you expect a set of users to consume the machine resources at a specific time on specific days, use Autoscale to set multiple schedules that include specific days of the week. You can then adjust the number of machines available during those times. Designate peak usage times for optimized behavior and to control other settings such as capacity buffer under Load-based Settings. [Learn more](#)

[Set schedules](#)

▼ New schedule

| Days applied: | Mon | Tue | Wed | Thu | Fri | Sat | Sun |
|---------------|----------------------|----------|----------|----------|----------|----------|----------|
| Machines | Edit | | | | | | |
| | 5 | 5 | 5 | 5 | 5 | 5 | 5 |
| | 4 | | | | | | |
| | 3 | | | | | | |
| | 2 | | | | | | |
| | 1 | | | | | | |
| | 0 | | | | | | |
| | 12:00 AM | 03:00 AM | 06:00 AM | 09:00 AM | 12:00 PM | 03:00 PM | 06:00 PM |
| Peak times | | | | | | | |

> Weekdays

> Weekend

Save
Cancel
Apply

Manage Autoscale Enabled

General

Schedule and Peak Ti...

Load-based Settings

ADVANCED

Restrict Autoscale

Load-based Settings

Capacity buffer is used to accommodate sudden spikes in demand by keeping a buffer of machines powered on based on the maximum load index of the delivery group. By default, the capacity buffer is 10% of the maximum supported load index of the delivery group. A lesser value decreases the cost. A greater value ensures an optimized user experience so that users do not have to wait for additional machines to power on when launching sessions. [Learn more](#)

| | During peak times | During off-peak times |
|------------------------------|---|---|
| Capacity buffer (%): | <input type="text" value="4"/> | <input type="text" value="10"/> |
| When disconnected (minutes): | <input type="text" value="2"/> <input type="text" value="Suspend"/> | <input type="text" value="3"/> <input type="text" value="Shut down"/> |

Autoscale user interface for *multi-session OS delivery groups*:

Manage Autoscale Enabled

- General
- Schedule and Peak Ti...
- Load-based Settings

ADVANCED

- Dynamic Session Tim...
- Force User Logoff
- Restrict Autoscale

Schedule and Peak Times

If you expect a set of users to consume the machine resources at a specific time on specific days, use Autoscale to set multiple schedules that include specific days of the week. You can then adjust the number of machines available during those times. Designate peak usage times for optimized behavior and to control other settings such as capacity buffer under Load-based Settings. [Learn more](#)

[Set schedules](#)

▼ New schedule

| Days applied: | Mon | Tue | Wed | Thu | Fri | Sat | Sun |
|---------------|----------------------|-----|-----|-----|-----|-----|-----|
| Machines | Edit | | | | | | |
| | 5 | 5 | 5 | 1 | 5 | 5 | 5 |

Peak times

- > Weekdays
- > Weekend

[Save](#) [Cancel](#) [Apply](#)

Manage Autoscale Enabled

General

Schedule and Peak Ti...

Load-based Settings

ADVANCED

Dynamic Session Tim...

Force User Logoff

Restrict Autoscale

Load-based Settings

Capacity buffer is used to accommodate sudden spikes in demand by keeping a buffer of machines powered on based on the maximum load index of the delivery group. By default, the capacity buffer is 10% of the maximum supported load index of the delivery group. A lesser value decreases the cost. A greater value ensures an optimized user experience so that users do not have to wait for additional machines to power on when launching sessions. [Learn more](#)

| | During peak times | During off-peak times |
|----------------------|--|--|
| Capacity buffer (%): | <input style="width: 40px; border: 1px solid #ccc;" type="text" value="11"/> | <input style="width: 40px; border: 1px solid #ccc;" type="text" value="12"/> |

Schedule-based settings

Autoscale schedule. Lets you add, edit, select, and delete schedules.

Days applied. Highlights the days you applied to the selected schedule. The remaining days are grayed out.

Edit. Lets you assign the machines against each hour or each half hour. You can assign the machines by numbers and by percentages.

Note:

- This option is available only in the Autoscale user interfaces for multi-session OS and single-session OS random delivery groups.
- The histogram next to **Edit** plots the number or percentage of machines that are running in different time slots.
- You can **assign machines** against each time slot by clicking **Edit** above **Peak times**. Depending on the option you selected from the menu in the **Machines to start** window, you

Important:

- For multi-session OS delivery groups, the peak times bar graph is used for the capacity buffer.
- For single-session OS delivery groups, the peak times bar graph is used for the capacity buffer and controls the actions to be triggered after logoff and/or disconnection.
- You can define the peak times for the days included in a schedule at a granular level of 30 minutes for both multi-session OS and single-session OS delivery groups. Alternatively, you can use the `New-BrokerPowerTimeScheme PowerShell` command instead. For more information, see [Broker PowerShell SDK commands](#).

Capacity buffer. Lets you keep a buffer of powered-on machines. A lesser value decreases the cost. A greater value ensures an optimized user experience so that when launching sessions, users do not have to wait for additional machines to power on. By default, the capacity buffer is 10% for peak and off-peak times. If you set the capacity buffer to 0 (zero), users might have to wait for additional machines to power on when launching sessions. Autoscale lets you determine the capacity buffer separately for peak and off-peak times.

Miscellaneous settings

Tip:

- You can choose to configure the miscellaneous settings using the Broker PowerShell SDK. For more information, see [Broker PowerShell SDK commands](#).
- To understand the SDK commands associated with the when disconnected and when logged off settings, see https://citrix.github.io/delivery-controller-sdk/Broker/about_Broker_PowerManagement/#power-policy.

When disconnected. Lets you specify how long a disconnected, locked machine remains powered on after session disconnection before it is suspended or shut down. If a time value is specified, the machine is suspended or shut down when the specified disconnection time elapses, depending on the action you configured. By default, no action is assigned to disconnected machines. You can define actions separately for peak and off-peak times. To do so, click the down arrow and then select one of the following options from the menu:

- **No action.** If selected, the machine after session disconnection remains powered on. Autoscale does not act on it.
- **Suspend.** If selected, Autoscale pauses the machine without shutting it down when the specified disconnection time elapses. The following option becomes available after you select **Suspend**.

- **When no reconnection in (minutes).** Suspended machines remain available to disconnected users when they reconnect but are not available for new users. To make the machines available again to handle all workloads, shut them down. Specify the timeout, in minutes, after which Autoscale shuts them down.
- **Shut down.** If selected, Autoscale shuts down the machine when the specified disconnection time elapses.

Note:

This option is available only in the Autoscale user interfaces for single-session OS random and static delivery groups.

When logged off. Lets you specify how long a machine remains powered on after session logoff before it is suspended or shut down. If a time value is specified, the machine is suspended or shut down when the specified logoff time elapses, depending on the actions you configured. By default, no action is assigned to logged-off machines. You can define actions separately for peak and off-peak times. To do so, click the down arrow and then select one of the following options from the menu:

- **No action.** If selected, the machine after session logoff remains powered on. Autoscale does not act on it.
- **Suspend.** If selected, Autoscale pauses the machine without shutting it down when the specified logoff time elapses.
- **Shut down.** If selected, Autoscale shuts down the machine when the specified logoff time elapses.

Note:

This option is available only in the Autoscale user interface for single-session OS static delivery groups.

Power manage single-session OS machines transitioning to a different time period with disconnected sessions

Important:

- This enhancement applies only to single-session OS machines with disconnected sessions. It does not apply to single-session OS machines with logged off sessions.
- For this enhancement to take effect, you need to enable Autoscale for the applicable delivery group. Otherwise, disconnect power policy actions are not triggered on period transition.

In earlier releases, a single-session OS machine transitioning to a time period where an action (disconnect action="Suspend" or "Shutdown") was required remained powered on. This scenario occurred

if the machine disconnected during a time period (peak or off-peak times) where no action (disconnect action="Nothing") was required.

Starting with this release, Autoscale suspends or powers off the machine when the specified disconnection time elapses, depending on the disconnect action configured for the destination time period.

For example, you configure the following power policies for a single-session OS delivery group:

- Set `PeakDisconnectAction` to "Nothing"
- Set `OffPeakDisconnectAction` to "Shutdown"
- Set `OffPeakDisconnectTimeout` to "10"

Note:

For more information about the disconnect action power policy, see https://developer-docs.citrix.com/projects/delivery-controller-sdk/en/latest/Broker/about_Broker_PowerManagement/#power-policy and <https://developer-docs.citrix.com/projects/delivery-controller-sdk/en/latest/Broker/Get-BrokerDesktopGroup/>.

In earlier releases, a single-session OS machine with a session disconnected during peak times remained powered on when it transitioned from peak to off-peak. Starting with this release, the `OffPeakDisconnectAction` and the `OffPeakDisconnectTimeout` policy actions are applied to the single-session OS machine on period transition. As a result, the machine is powered off 10 minutes after it transitions to off-peak.

In case you want to revert to the previous behavior (that is, take no action on machines that transition from peak to off-peak or off-peak to peak with disconnected sessions), do one of the following:

- Set the "LegacyPeakTransitionDisconnectedBehaviour" registry value to 1 (true; enables the previous behavior). By default, the value is 0 (false; triggers disconnect power policy actions on period transition).
 - Path: HKEY_LOCAL_MACHINE\SOFTWARE\Citrix\DesktopServer
 - Name: LegacyPeakTransitionDisconnectedBehaviour
 - Type: REG_DWORD
 - Data: 0x00000001 (1)
- Configure the setting by using the `Set-BrokerServiceConfigurationData` PowerShell command. For example:
 - `PS C:\> Set-BrokerServiceConfigurationData HostingManagement.LegacyPeakTransitionDisconnectedBehaviour -SettingValue $true`

A machine must meet the following criteria before power policy actions can be applied to it on period transition:

- Has a disconnected session.
- Has no pending power actions.
- Belongs to a single-session OS delivery group that transitions to a different time period.
- Has a session that disconnects during a certain time period (peak or off-peak times) and transitions to a period where a power action is assigned.

How capacity buffer works

Capacity buffer is used to add spare capacity to the current demand to account for dynamic load increases. There are two scenarios to be aware of:

- For multi-session OS delivery groups, the capacity buffer is defined as a percentage of the total capacity of the delivery group in terms of load index. For more information about load index, see [Load index](#).
- For single-session OS delivery groups, the capacity buffer is defined as a percentage of the total capacity of the delivery group in terms of the number of machines.

Note:

In scenarios where you restrict Autoscale to tagged machines, the capacity buffer is defined as a percentage of the total capacity of the tagged machines in the delivery group in terms of load index.

Autoscale lets you set the capacity buffer separately for peak and off-peak times. A lesser value in the capacity buffer field decreases the cost because Autoscale powers on less spare capacity. A greater value ensures an optimized user experience so that users do not have to wait for additional machines to power on when launching sessions. By default, the capacity buffer is 10%.

Important:

The capacity buffer results in machines being powered on when the total spare capacity drops to a level below “X” percent of the total capacity of the delivery group. Doing so reserves the required percentage of spare capacity.

Multi-session OS delivery groups

When are machines powered on?

Important:

If a schedule is selected, Autoscale powers on all machines configured to be powered on in the schedule. Autoscale keeps this specified number of machines powered on during the schedule,

regardless of the load.

When the number of powered-on machines in the delivery group can no longer meet the buffer needed for honoring the buffer capacity in terms of load index, Autoscale powers on extra machines. For example, let's say your delivery group has 20 machines and 3 machines are scheduled to be powered on as part of schedule-based scaling with a capacity buffer of 20%. Eventually, 4 machines will be powered on when there is no load. This is because a 4 x 10k load index is needed as a buffer; therefore at least 4 machines need to be powered on. This case might occur during peak times, increased load on machines, new session launches, and when you add new machines to the delivery group. Note that Autoscale powers on only the machines that meet the following criteria:

- The machines are not in maintenance mode.
- The hypervisor on which the machines are running is not in maintenance mode.
- The machines are currently powered off.
- The machines have no pending power actions.

When are machines powered off?

Important:

- If a schedule is selected, Autoscale powers off the machines based on the schedule.
- Autoscale does not power off the machines configured in the schedule to be powered on during the schedule.

When there are more than enough machines to support the targeted number of powered-on machines (including the buffer) for the delivery group, Autoscale powers off extra machines. This case might occur during off-peak times, decreased load on machines, and session logoffs, and when you remove machines from the delivery group. Autoscale powers off only the machines that meet the following criteria:

- The machines and the hypervisor on which the machines are running are not in maintenance mode.
- The machines are currently powered on.
- The machines are registered as available or waiting to register after start-up.
- The machines have no active sessions.
- The machines have no pending power actions.
- The machines satisfy the specified power-off delay. This means that the machines have been powered on for at least "X" minutes, where "X" is the power-off delay specified for the delivery group.

Example scenario

Suppose you have the following scenario:

- **Delivery group configuration.** The delivery group that you want Autoscale to power manage contains 10 machines (M1 to M10).
- **Autoscale configuration**
 - Capacity buffer is set to 10%.
 - No machine is included in the selected schedule.

The scenario is executed in the following sequence:

1. No user logs on.
2. User sessions increase.
3. More user sessions start.
4. User session load decreases because of session termination.
5. User session load decreases further until the session load is handled only by on-premises resources.

See below for details about how Autoscale works in the scenario above.

- No user load (initial state)
 - One machine (for example, M1) is powered on. The machine is powered on because of the configured capacity buffer. In this case, 10 (number of machines) \times $10,000$ (load index) \times 10% (configured capacity buffer) equals $10,000$. Therefore, one machine is powered on.
 - The load index value of the powered-on machine (M1) is at a baseline load (load index equals 0).
- The first user logs on
 - The session is directed to be hosted on machine M1.
 - The load index of the powered-on machine M1 increases and machine M1 is no longer at a baseline load.
 - Autoscale starts to power on an additional machine (M2) to meet the demand because of the configured capacity buffer.
 - The load index value of machine M2 is at a baseline load.
- Users increase load
 - The sessions are load-balanced across machines M1 and M2. As a result, the load index of the powered-on machines (M1 and M2) increases.
 - The total spare capacity is still at a level above $10,000$ in terms of load index.

- The load index value of machine M2 is no longer at a baseline load.
- More user sessions start
 - The sessions are load-balanced across machines (M1 and M2). As a result, the load index of the powered-on machines (M1 and M2) increases further.
 - When the total spare capacity drops to a level below 10,000 in terms of load index, Autoscale starts to power on an additional machine (M3) to meet the demand because of the configured capacity buffer.
 - The load index value of machine M3 is at a baseline load.
- Even more user sessions start
 - The sessions are load-balanced across machines (M1 to M3). As a result, the load index of the powered-on machines (M1 to M3) increases.
 - The total spare capacity is at a level above 10,000 in terms of load index.
 - The load index value of machine M3 is no longer at a baseline load.
- User session load decreases because of session termination
 - After users log off from their sessions or idle sessions time out, the freed-up capacity on machines M1 to M3 is reused to host sessions started by other users.
 - When the total spare capacity increases to a level above 10,000 in terms of load index, Autoscale puts one of the machines (for example, M3) into drain state. As a result, sessions started by other users are no longer directed to that machine unless new changes occur. For example, end-user load increases again or other machines become least loaded.
- User session load continues to decrease
 - After all sessions on machine M3 are terminated and the specified power-off delay times out, Autoscale powers off machine M3.
 - After more users terminate their sessions, the freed-up capacity on powered-on machines (M1 and M2) is reused to host sessions started by other users.
 - When the total spare capacity increases to a level above 10,000 in terms of load index, Autoscale puts one of the machines (for example, M2) into drain state. As a result, sessions started by other users are no longer directed to that machine.
- User session load continues to decrease until there are no sessions
 - After all sessions on machine M2 are terminated and the specified power-off delay times out, Autoscale powers off machine M2.
 - The load index value of the powered-on machine (M1) is at a baseline load. Autoscale does not put machine M1 into drain state because of the configured capacity buffer.

Note:

For multi-session OS delivery groups, all changes to the desktop are lost when users log off sessions. However, if configured, user-specific settings are roamed along with the user profile.

Single-session OS random delivery groups

Capacity buffer is used to accommodate sudden spikes in demand by keeping a buffer of machines powered on based on the total number of machines in the delivery group. By default, the capacity buffer is 10% of the total number of machines in the delivery group.

If the number of machines (including the capacity buffer) exceeds the total number of currently powered-on machines, additional machines are powered on to meet the demand. If the number of machines (including the capacity buffer) is less than the total number of currently powered-on machines, the excess machines are shut down or suspended, depending on the actions you configured.

Example scenario

Suppose you have the following scenario:

- **Delivery group configuration.** The delivery group that you want Autoscale to power manage contains 10 machines (M1 to M10).
- **Autoscale configuration**
 - Capacity buffer is set to 10%.
 - No machine is included in the selected schedule.

The scenario is executed in the following sequence:

1. No user logs on.
2. User sessions increase.
3. More user sessions start.
4. User session load decreases because of session termination.
5. User session load decreases further until the session load is handled only by on-premises resources.

See below for details about how Autoscale works in the scenario above.

- No user load (initial state)

- One machine (M1) is powered on. The machine is powered on because of the configured capacity buffer. In this case, 10 (number of machines) x 10% (configured capacity buffer) equals 1. Therefore, one machine is powered on.
- A first user logs on
 - The first time a user logs on to use a desktop, the user is assigned a desktop from a pool of desktops hosted on powered-on machines. In this case, the user is assigned a desktop from machine M1.
 - Autoscale starts to power on an additional machine (M2) to meet the demand because of the configured capacity buffer.
- A second user logs on
 - The user is assigned a desktop from machine M2.
 - Autoscale starts to power on an additional machine (M3) to meet the demand because of the configured capacity buffer.
- A third user logs on
 - The user is assigned a desktop from machine M3.
 - Autoscale starts to power on an additional machine (M4) to meet the demand because of the configured capacity buffer.
- A user logs off
 - After a user logs off or the user's desktop times out, the freed-up capacity (for example, M3) is available as buffer. As a result, Autoscale starts to power off machine M4 because the capacity buffer is configured as 10%.
- More users log off until there are no users
 - After more users log off, Autoscale powers off machines (for example, M2 or M3).
 - Even though there are no users left, Autoscale does not power off the remaining one machine (for example, M1) because that machine is reserved as a spare capacity.

Note:

For single-session OS random delivery groups, all changes to the desktop are lost when users log off sessions. However, if configured, user-specific settings are roamed along with the user profile.

Single-session OS static delivery groups

Capacity buffer is used to accommodate sudden spikes in demand by keeping a buffer of unassigned machines powered on based on the total number of unassigned machines in the delivery group. By default, the capacity buffer is 10% of the total number of unassigned machines in the delivery group.

Important:

After all machines in the delivery group are assigned, the capacity buffer does not play a role in powering machines on or off.

If the number of machines (including the capacity buffer) exceeds the total number of currently powered-on machines, additional, unassigned machines are powered on to meet the demand. If the number of machines (including the capacity buffer) is less than the total number of currently powered-on machines, excess machines are powered off or suspended, depending on the actions you configured.

For single-session OS static delivery groups, Autoscale:

- Powers assigned machines on during peak times and off during off-peak times only when the `AutomaticPowerOnForAssigned` property of the applicable single-session OS delivery group is set to true.
- Automatically powers on a machine during peak times if it is powered off and the `AutomaticPowerOnForAssignedDuringPeak` property of the delivery group to which it belongs is set to true.

To understand how capacity buffer works with assigned machines, consider the following:

- The capacity buffer works only when the delivery group has one or more unassigned machines.
- If the delivery group has no unassigned machines (all machines in the delivery group are assigned), the capacity buffer does not play a role in powering machines on or off.
- The `AutomaticPowerOnForAssignedDuringPeak` property determines whether assigned machines are powered on during peak times. If it is set to true, Autoscale keeps the machines powered on during peak times. Autoscale will also power them on even if they are powered off.

Example scenario

Suppose you have the following scenario:

- **Delivery group configuration.** The delivery group that you want Autoscale to power manage contains 10 machines (M1 to M10).
- **Autoscale configuration**
 - Machines M1 to M3 are assigned, and machines M4 to M10 are unassigned.
 - Capacity buffer set to 10% for peak and off-peak times.
 - According to the selected schedule, Autoscale power manages machines between 09:00 AM and 06:00 PM.

See below for details about how Autoscale works in the scenario above.

- Start of schedule –09:00 AM
 - Autoscale powers on machines M1 to M3.
 - Autoscale powers on an additional machine (for example, M4) because of the configured capacity buffer. Machine M4 is unassigned.
- A first user logs on
 - The first time a user logs on to use a desktop, the user is assigned a desktop from a pool of desktops hosted on unassigned powered-on machines. In this case, the user is assigned a desktop from machine M4. Subsequent logons from that user connect to the same desktop that was assigned on first use.
 - Autoscale starts to power on an additional machine (for example, M5) to meet the demand because of the configured capacity buffer.
- A second user logs on
 - The user is assigned a desktop from the unassigned powered-on machines. In this case, the user is assigned a desktop from machine M5. Subsequent logons from that user connect to the same desktop that was assigned on first use.
 - Autoscale starts to power on an additional machine (for example, M6) to meet the demand because of the configured capacity buffer.
- Users log off
 - As users log off from their desktops or the desktops time out, Autoscale keeps the machines M1 to M5 powered on during 09:00 AM –06:00 PM. When those users log on the next time, they connect to the same desktop that was assigned on first use.
 - The unassigned machine M6 is waiting to serve a desktop to an incoming, unassigned user.
- End of schedule –06:00 PM
 - At 06:00 PM, Autoscale powers off machines M1 to M5.
 - Autoscale keeps the unassigned machine M6 powered on because of the configured capacity buffer. That machine is waiting to serve a desktop to an incoming, unassigned user.
 - In the delivery group, machines M6 to M10 are unassigned machines.

Dynamic session timeouts

August 3, 2023

This feature lets you configure disconnected and idle session timeouts for your peak and off-peak usage times to achieve faster machine draining and cost savings. This feature applies to single-session

and multi-session OS machines. A VDA reports idle times for sessions that have been idle for more than 10 minutes, so dynamic session timeouts will not be able to disconnect idle sessions within 10 minutes of being idle. A lesser value removes lingering sessions sooner, thus reducing costs.

Manage Autoscale Enabled

CYAZinfo1027

✕

General

Schedule and Peak Times

Load-based Settings

ADVANCED

Dynamic Session Timeout

Force User Logoff

Autoscaling Tagged Machines

Dynamic Session Timeout

Configure dynamic timeouts for your peak and off-peak usage times to achieve faster VM draining and cost savings. Larger values can improve user experience and smaller values can achieve faster draining. [Learn more](#)

| | During peak times | | During off-peak times |
|---|---|---|-----------------------|
| Idle session timeout: ? | <input type="text" value="Disable"/> <input type="text" value="min"/> | <input type="text" value="3"/> <input type="text" value="min"/> | |
| Disconnected session timeout: ? | <input type="text" value="4"/> <input type="text" value="min"/> | <input type="text" value="5"/> <input type="text" value="min"/> | |

⚠ Autoscale dynamic timeouts are for cost savings. If used for security purposes, the configured timeouts might conflict with your GPO or Studio policies. When a conflict occurs, the shorter timeout prevails. [↗](#)

↶

Note:

- This feature is always available for multi-session OS delivery groups.
- For single-session OS delivery groups, this feature applies to VDAs of version 2206 CR or later, or 2203 LTSR CU3 or later. Ensure that those VDAs have registered with Citrix Cloud at least once. When unavailable, the following user interface appears:

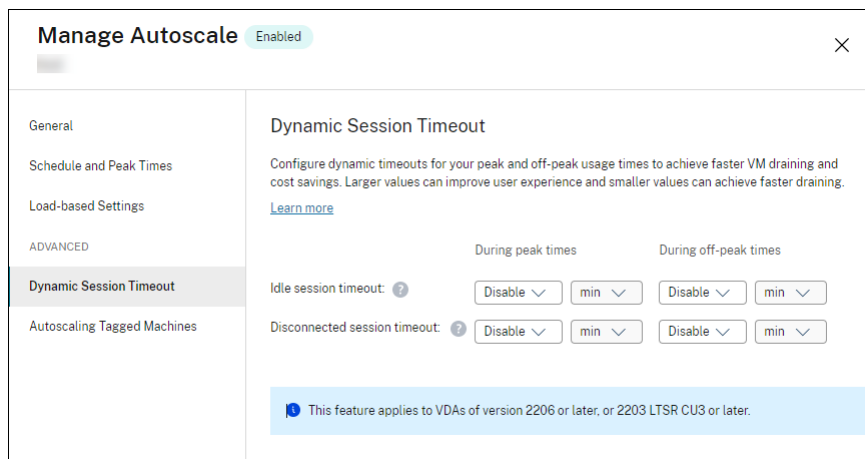

- Autoscale dynamic timeouts are for cost savings. If used for security purposes, the configured timeouts might conflict with your GPO or Manage console policies. When a conflict occurs, the shorter timeout prevails.

Idle session timeout. Enables or disables a timer that specifies how long an uninterrupted user connection is maintained if there is no user input. When the timer expires, the session is placed in the disconnected state and the **Disconnected session timeout** applies. If the **Disconnected session timeout** is disabled, the session is not logged off.

Important:

- If you specify a value less than or equal to 10 minutes (600 seconds), Autoscale disconnects the relevant sessions after they have been idle for 10 minutes. This is because Autoscale relies on session idle times that VDAs report. VDAs report idle times only for sessions that have been idle for more than 10 minutes.
- An idle session will still be placed into a disconnected state if the user interacts with it within the last 5 minutes of reaching the idle session timeout.

Disconnected session timeout. Enables or disables a timer that specifies how long a disconnected desktop remains locked before the session is logged off. If enabled, the disconnected session is logged off when the timer expires.

Autoscaling tagged machines (cloud burst)

May 9, 2023

Note:

This feature was formerly Restrict Autoscale.

Introduction

Autoscale provides the flexibility to power manage only a subset of machines in a delivery group. To achieve this, apply a tag to one or more machines and then configure Autoscale to power manage only tagged machines.

This feature can be useful in cloud bursting use cases, where you want to use on-premises resources (or reserved public cloud instances) to handle workloads before cloud-based resources address additional demand (that is, burst workloads). To let on-premises machines (or reserved instances) address workloads first, you must use tag restriction along with zone preference.

Tag restriction specifies machines to be power managed by Autoscale. Zone preference specifies machines in the preferred zone to handle user launch requests. For more information, see [Tags](#) and [Zone preference](#).

To autoscale certain tagged machines, you can use the Manage console or PowerShell.

Use the Manage console to autoscale certain tagged machines

To autoscale certain tagged machines, complete the following steps:

1. Create a tag and apply that tag to the applicable machines in the delivery group. For more information, see [Manage tags and tag restrictions](#).
2. Select the delivery group and then open the **Manage Autoscale** wizard.
3. On the **Autoscaling Tagged Machines** page, select **Enable Autoscale for machines with tag**, select a tag from the list, and then click **Apply** to save your changes.

User interface for single-session OS *static* and *random* delivery groups:

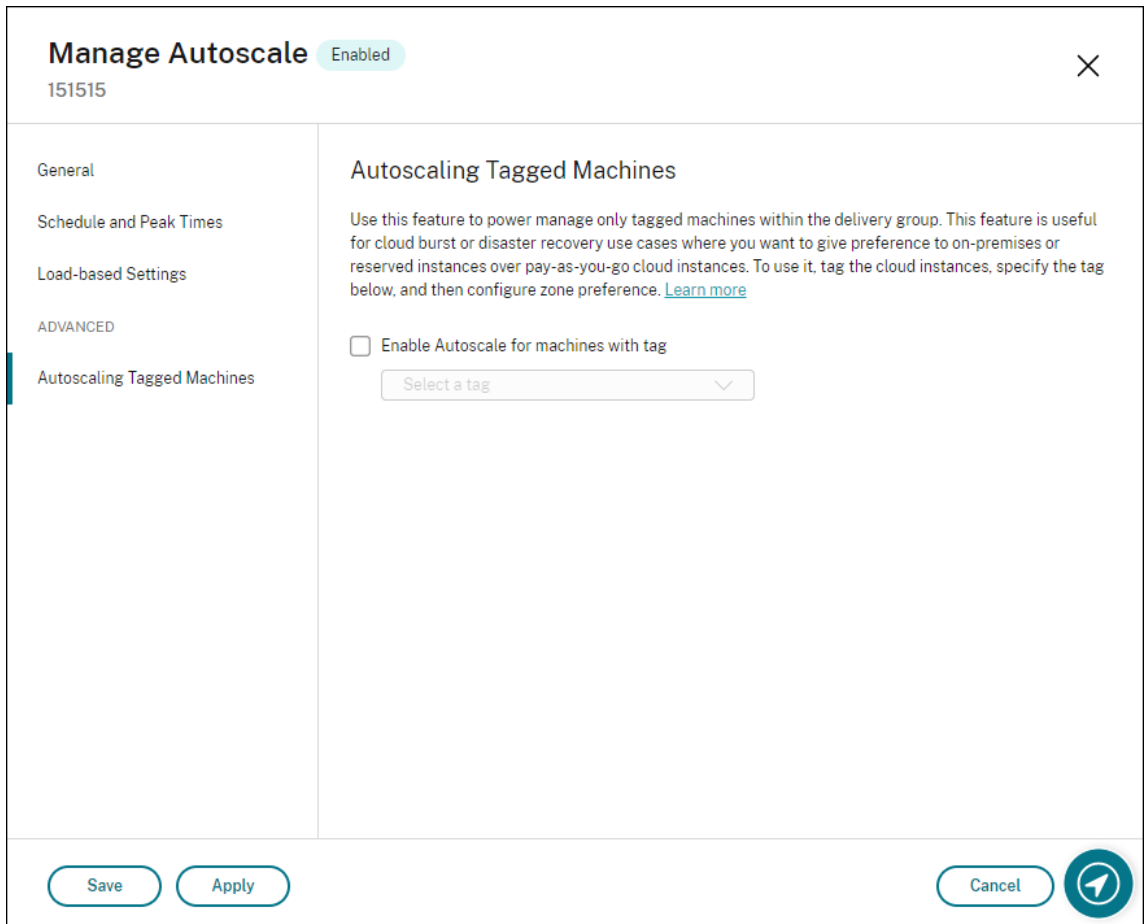

User interface for *multi-session OS delivery groups*:

Manage Autoscale Enabled

CYAZinfo1027

General

Schedule and Peak Times

Load-based Settings

ADVANCED

Dynamic Session Timeout

Force User Logoff

Autoscaling Tagged Machines

Autoscaling Tagged Machines

Use this feature to power manage only tagged machines within the delivery group. This feature is useful for cloud burst or disaster recovery use cases where you want to give preference to on-premises or reserved instances over pay-as-you-go cloud instances. To use it, tag the cloud instances, specify the tag below, and then configure zone preference. [Learn more](#)

Enable Autoscale for machines with tag

Select a tag

Save Apply Cancel 

Warning:

- Autoscaling machines with a specific tag might cause the histogram to update automatically to reflect the number of machines per the tag. On the **Schedule and Peak Times** page, you can manually assign machines against each time slot if needed.
- You cannot delete a tag that is being used on tagged machines. To delete the tag, you must first remove the tag restriction.

After you apply the tag restriction, you might want to remove it from the delivery group later. To do so, go to the **Manage Autoscale > Autoscaling Tagged Machines** page and then clear **Enable Autoscale for machines with tag**.

Warning:

- If you remove the tag from the applicable machines without clearing **Enable Autoscale for machines with tag**, you might receive a warning when you open the **Manage Autoscale** wizard. Removing the tag from the machines can leave no machines for Autoscale to manage because the tag you specified in Autoscale has become invalid. To resolve the warning,

go to the **Autoscaling Tagged Machines** page, remove the invalid tag, and then click **Apply** to save your changes.

Control when Autoscale powers on resources

You can also control when Autoscale starts powering on tagged machines based on the usage of untagged machines. This helps you further optimize the consumption of your tagged or public cloud workloads.

To do this, complete the following steps:

1. On the **Autoscaling Tagged Machines** page, select **Control when Autoscale starts powering on tagged machines**.
2. Enter the percentage amount of untagged machine usage you want to reach for both peak times and off-peak times and then click **Apply**. Supported values: 0–100.

Manage Autoscale Enabled

✕

General

Schedule and Peak Times

Load-based Settings

ADVANCED

Dynamic Session Timeout

User Logoff Notifications

Autoscaling Tagged Machines

Autoscaling Tagged Machines

Use this feature to power manage only tagged machines within the delivery group. This feature is useful for cloud burst or disaster recovery use cases where you want to give preference to on-premises or reserved instances over pay-as-you-go cloud instances. To use it, tag the cloud instances, specify the tag below, and then configure zone preference. [Learn more](#)

Enable Autoscale for machines with tag

▼

Control when Autoscale starts powering on tagged machines ?

| | During peak times | During off-peak times |
|--|--|--|
| When percentage of remaining untagged capacity falls below (%) ? | <input style="width: 40px;" type="text" value="10"/> | <input style="width: 40px;" type="text" value="10"/> |

Save
Cancel

?

Tip:

The percentage controls when Autoscale starts powering on tagged machines. When the percentage falls below the threshold (default, 10%), Autoscale starts powering on tagged machines. When the percentage exceeds the threshold, Autoscale goes into power-off mode. When entering the percentage, consider two scenarios:

- For single-session OS delivery groups: The value is defined as a percentage of the total number of untagged machines in idle state. Example: You have 10 untagged single-session OS machines. When only one is left without a session, Autoscale starts powering on a tagged machine.
- For multi-session OS delivery groups: The value is defined as a percentage of the total capacity (in terms of load index) of available untagged machines. Example: You have 10 un-

tagged multi-session OS machines. When they are 90% loaded, Autoscale starts powering on a tagged machine.

Use PowerShell to autoscale certain tagged machines

To use the PowerShell SDK directly, complete the following steps:

1. **Create a tag.** Use the `New-BrokerTag` PowerShell command to create a tag.
 - For example: `$managed = New-BrokerTag Managed`. In this case, the tag is named “Managed.” For more information about the `New-BrokerTag` PowerShell command, see <https://developer-docs.citrix.com/projects/delivery-controller-sdk/en/latest/Broker/New-BrokerTag/>.
2. **Apply the tag to machines.** Use the `Get-BrokerMachine` PowerShell command to apply the tag to machines in a catalog that you want Autoscale to power manage.
 - For example: `Get-BrokerMachine -CatalogName "cloud" | Add-BrokerTag $managed.Name`. In this case, the catalog is named “cloud.”
 - For more information about the `Get-BrokerMachine` PowerShell command, see <https://developer-docs.citrix.com/projects/delivery-controller-sdk/en/latest/Broker/Get-BrokerMachine/>.

Note:

You might add new machines to the catalog after applying the tag. The tag is *NOT* automatically applied to those new machines.

3. **Add tagged machines to the delivery group that you want Autoscale to power manage.** Use the `Get-BrokerDesktopGroup` PowerShell command to add a tag restriction to the delivery group that contains the machines (in other words, “restrict launches to machines with tag X”).
 - For example: `Get-BrokerDesktopGroup -Uid 1 | Set-BrokerDesktopGroup -RestrictAutoscaleTagUid $managed.Uid`. In this case, the UID of the Delivery Group is 1.
 - For more information about the `Get-BrokerDesktopGroup` PowerShell command, see <https://developer-docs.citrix.com/projects/delivery-controller-sdk/en/latest/Broker/Get-BrokerDesktopGroup/>.

After you apply the tag restriction, you might want to remove it from the delivery group later. To do so, use the `Get-BrokerDesktopGroup` PowerShell command.

Example: `Get-BrokerDesktopGroup -Uid 1 | Set-BrokerDesktopGroup -RestrictAutoscaleTagUid $null`. In this case, the UID of the delivery group is 1.

Note:

Untagged machines restart automatically after users power them off. This behavior ensures that they become available to handle workloads sooner. This can be enabled or disabled on a per desktop group using the `Set-BrokerDesktopGroup's AutomaticRestartForUntaggedMachines` property. For more information, see <https://citrix.github.io/delivery-controller-sdk/Broker/Set-BrokerDesktopGroup/>.

Example scenario

Suppose you have the following scenario:

- **Machine catalog configuration.** There are two machine catalogs (C1 and C2).
 - Catalog C1 contains 5 machines (M1 to M5) that are local in the on-premises deployments.
 - Catalog C2 contains 5 machines (M6 to M10) that are remote in the cloud deployments.
- **Tag restriction.** A tag named “Cloud” is created and applied to machines M6 to M10 in catalog C2.
- **Zone configuration.** Two zones (Z1 and Z2) are created.
 - Zone Z1 containing catalog C1 corresponds to the on-premises deployments.
 - Zone Z2 containing catalog C2 corresponds to the cloud deployments.
- **Delivery group configuration**
 - The delivery group contains 10 machines (M1 to M10), 5 machines from catalogs C1 (M1 to M5) and 5 from catalog C2 (M6 to M10).
 - Machines M1 to M5 are powered on manually and remain powered on throughout the schedule.
- **Autoscale configuration**
 - Capacity buffer is set to 10%.
 - Autoscale power manages only machines with the tag “Cloud.” In this case, Autoscale power manages cloud machines M6 to M10.
- **Published application or desktop configuration.** Zone preferences are configured for the published desktops (for example), where Zone Z1 is preferred over Zone Z2 for a user launch request.
 - Zone Z1 is configured as the preferred zone (home zone) for the published desktops.

The scenario is executed in the following sequence:

1. No user logs on.
2. User sessions increase.
3. User sessions increase further until all available on-premises machines are consumed.
4. More user sessions start.
5. User session decreases because of session termination.
6. User session decreases further until the session load is handled only by on-premises machines.

See below for details about how Autoscale works in the scenario above.

- No user load (initial state)
 - The on-premises machines M1 to M5 are all powered on.
 - One machine in the cloud (for example, M6) is powered on. The machine is powered on because of the configured capacity buffer. In this case, 10 (number of machines) \times $10,000$ (load index) \times 10% (configured capacity buffer) equals $10,000$. Therefore, one machine is powered on.
 - The load index value of all the powered-on machines (M1 to M6) is at a baseline load (load index equals 0).
- Users log on
 - The sessions are directed to be hosted on machines M1 to M5 through the configured zone preference and are load-balanced across these on-premises machines.
 - The load index value of the powered-on machines (M1 to M5) increases.
 - The load index value of the powered-on machine M6 is at a baseline load.
- Users increase load, consuming all on-premises resources
 - The sessions are directed to be hosted on machine M1 to M5 through the configured zone preference and are load-balanced across these on-premises machines.
 - The load index value of all the powered-on machines (M1 to M5) has reached $10,000$.
 - The load index value of the powered-on machine M6 remains at a baseline load.
- One more user logs on
 - The session overflows the zone preference and is directed to be hosted on cloud machine M6.
 - The load index value of all the powered-on machines (M1 to M5) has reached $10,000$.
 - The load index value of the powered-on machine M6 increases and is no longer at a baseline load. When the total spare capacity drops to a level below $10,000$ in terms of load index, Autoscale starts to power on an additional machine (M7) to meet the demand because of the configured capacity buffer. Note that it might take some time to power on machine M7. So there might be a delay until machine M7 is ready.
- More users log on

- The sessions are directed to be hosted on machine M6.
- The load index value of all the powered-on machines (M1 to M5) has reached 10,000.
- The load index value of the powered-on machine M6 increases further, but the total spare capacity is at a level above 10,000 in terms of load index.
- The load index value of the powered-on machine M7 remains at a baseline load.
- Even more users log on
 - After machine M7 is ready, the sessions are directed to be hosted on machines M6 and M7 and are load-balanced across these machines.
 - The load index value of all the powered-on machines (M1 to M5) has reached 10,000.
 - The load index value of machine M7 is no longer at a baseline load.
 - The load index value of the powered-on machines (M6 and M7) increases.
 - The total spare capacity is still at a level above 10,000 in terms of load index.
- User session load decreases because of session termination
 - After users log off from their sessions or idle sessions time out, the freed-up capacity on machines M1 to M7 is reused to host sessions started by other users.
 - When the total spare capacity increases to a level above 10,000 in terms of load index, Autoscale puts one of the cloud machines (M6 to M7) into drain state. As a result, sessions started by other users are no longer directed to that machine (for example, M7) unless new changes occur; for example, user load increases again or other cloud machines become least loaded.
- User session load decreases further until one or more cloud machines are no longer needed
 - After all sessions on machine M7 are terminated and the specified power-off delay times out, Autoscale powers off machine M7.
 - The load index value of all the powered-on machines (M1 to M5) might drop to a level below 10,000.
 - The load index value of the powered-on machine (M6) decreases.
- User session decreases further until no cloud machines are needed.
 - Even though there are no user sessions on machine M6, Autoscale does not power it off because it is reserved as a spare capacity.
 - Autoscale keeps the remaining cloud machine M6 powered on because of the configured capacity buffer. That machine is waiting to serve a desktop to an incoming user.
 - Sessions are not directed to be hosted on machine M6 as long as the on-premises machines have available capacity.

User logoff notifications (formerly force user logoff)

May 9, 2023

Important:

This feature is available only in the Autoscale user interface for multi-session app-based delivery groups.

To better achieve cost savings, Autoscale lets you force log off lingering sessions. It does so by letting you send a custom notification to the users and specify a grace period after which the sessions are force logged off. This is done only for machines in [drain state](#) and not for all powered-on machines. To avoid potential data loss caused by forcing user logoffs, you can instead configure this feature to only send logoff reminders without forcing user logoff.

You have the following two options:

- **Notify and force user logoff**
- **Send logoff reminders without forcing user logoff**

Notify and force user logoff

If selected, Autoscale logs off users from their sessions after the times specified below.

The screenshot shows the 'Manage Autoscale' configuration window, specifically the 'User Logoff Notifications' section. The window title is 'Manage Autoscale' with a status indicator 'Enabled' and a close button 'X'. The left sidebar contains navigation options: 'General', 'Schedule and Peak Times', 'Load-based Settings', 'ADVANCED', 'Dynamic Session Timeout', 'User Logoff Notifications', and 'Autoscaling Tagged Machines'. The main content area is titled 'User Logoff Notifications' and includes the following text: 'Use this feature to shut down machines faster by removing lingering sessions from the machines in drain state. You can send a notification to users before logging them off after the specified time. To avoid potential data loss caused by forcing user logoffs, you can also configure this feature to only send logoff reminders without forcing user logoff. [Learn more](#)'. There are two radio button options: 'Notify and force user logoff' (selected) and 'Send logoff reminders without forcing user logoff'. Below these are two checkboxes: 'Enable force logoff during peak times' and 'Enable force logoff during off-peak times', each with a text input field for 'min'. A section titled 'Display notification after machine enters drain state' contains 'Notification title' and 'Notification message' fields, with example text provided in a box. At the bottom, there is a blue 'Save' button, a 'Cancel' button, and a help icon. A footer note states: 'If the machine is already in drain state, there are some considerations to keep in mind when changing settings. [Learn more](#)'.

Enable force logoff during peak times. If selected, Autoscale logs off those users from their sessions during peak times when the specified time elapses.

Enable force logoff during off-peak times. If selected, Autoscale logs off those users from their sessions during off-peak times when the specified time elapses.

Display notification after machine enters drain state. Lets you send notifications to users after their machine enters drain state.

- **Notification title.** Lets you specify a title of the notification to be sent to users. Example: `A forced logoff has been initiated.`
- **Notification message.** Lets you specify the content of the notification to be sent to users. You can use `%s%` or `%m%` as variables to indicate the specified time in the message. To express the time in seconds, use `%s%`. To express the time in minutes, use `%m%`. Example: `Warning: To save costs, the machine shuts down in %s% seconds and you will be logged off from the session. Save your work and log back on to get a different machine.`

Send logoff reminders without forcing user logoff

If selected, users will receive a reminder to log off from their machine after it has entered drain state. This reminder can be configured to be sent at the interval specified below.

The screenshot shows the 'Manage Autoscale' configuration window, which is currently 'Enabled'. The 'User Logoff Notifications' section is active. It includes a description: 'Use this feature to shut down machines faster by removing lingering sessions from the machines in drain state. You can send a notification to users before logging them off after the specified time. To avoid potential data loss caused by forcing user logoffs, you can also configure this feature to only send logoff reminders without forcing user logoff. [Learn more](#)'.

Two radio buttons are present: 'Notify and force user logoff' (unselected) and 'Send logoff reminders without forcing user logoff' (selected). Below these are two checkboxes: 'Remind users during peak times' (unselected) and 'Remind users during off-peak times' (unselected). Each checkbox has a 'Send reminder every' field with a 'min' unit.

The 'Logoff reminder' section contains a 'Reminder title' field with the example text 'Example: Please log off from your session' and a 'Reminder message' field with the example text 'Example: To save costs, please log off from your session. Log back on to get a different machine. You are reminded every %m% minutes.'.

At the bottom, there is a blue 'Save' button, a 'Cancel' button, and a help icon. A small blue information icon is located above the text: 'If the machine is already in drain state, there are some considerations to keep in mind when changing settings. [Learn more](#)'.

Remind users during peak times. If selected, users receive a reminder to log off from their sessions during peak times every X minutes (X denotes the specified time).

Remind users during off-peak times. If selected, users receive a reminder to log off from their sessions during off-peak times every X minutes (X denotes the specified time).

Logoff reminder. Lets you configure the reminder sent to users after their machine enters drain state.

- **Reminder title.** Lets you specify a title for the reminder to be sent to users. Example: `Please log off from your session.`
- **Reminder message.** Lets you specify a message to be sent to users. Example: `Please log off from your session and log back on to save costs.`

Considerations

If the machine is already in drain state, consider the following when changing settings:

- If you change the setting from **Send logoff reminders without forcing user logoff** to **Notify and force user logoff**, the new setting takes effect immediately.
- If you change the setting from **Notify and force user logoff** to **Send logoff reminders without forcing user logoff**, the new setting does not take effect until the next time the machine enters drain state. The user is still forced to log off.

Broker PowerShell SDK commands

May 9, 2023

You can configure Autoscale for delivery groups using the Broker PowerShell SDK. To configure Autoscale using PowerShell commands, you must use PowerShell SDK version 7.21.0.12 or later. For more information about the PowerShell SDKs, see [SDKs and APIs](#).

Set-BrokerDesktopGroup

Disables or enables an existing BrokerDesktopGroup or alters its settings. For more information about this cmdlet, see <https://citrix.github.io/delivery-controller-sdk/Broker/Set-BrokerDesktopGroup/>.

Examples

See the following examples for details about how to use the PowerShell cmdlets.

Enable Autoscale

- Suppose you want to enable Autoscale for the delivery group whose name is “MyDesktop.” Use the `Set-BrokerDesktopGroup` PowerShell command. For example:

```
- PS C:\> Set-BrokerDesktopGroup "MyDesktop"-AutoscalingEnabled $true
```

Configure the capacity buffer separately for peak and off-peak times

- Suppose you want to set the capacity buffer to 20% for peak times and 10% for off-peak times for a delivery group whose name is “MyDesktop.” Use the `Set-BrokerDesktopGroup` PowerShell command. For example:

```
- PS C:\> Set-BrokerDesktopGroup "MyDesktop"-PeakBufferSizePercent 20 -OffPeakBufferSizePercent 10
```

Configure the **when disconnected timeout** setting

- Suppose you want to set the **when disconnected timeout** value to 60 minutes for peak times and 30 minutes for off-peak times for a delivery group whose name is “MyDesktop.” Use the `Set-BrokerDesktopGroup` PowerShell command. For example:

```
- PS C:\> Set-BrokerDesktopGroup "MyDesktop"-PeakDisconnectTimeout 60 -OffPeakDisconnectTimeout 30
```

Configure the **when logged off timeout** setting

- Suppose you want to set the **when logged off timeout** value to 60 minutes for peak times and 30 minutes for off-peak times for a delivery group whose name is “MyDesktop.” Use the `Set-BrokerDesktopGroup` PowerShell command. For example:

```
- PS C:\> Set-BrokerDesktopGroup "MyDesktop"-PeakLogOffTimeout 60 -OffPeakLogOffTimeout 30
```

Configure the **power-off delay** setting

- Suppose you want to set the power-off delay to 15 minutes for a delivery group whose name is “MyDesktop.” Use the `Set-BrokerDesktopGroup` PowerShell command. For example:

```
- PS C:\> Set-BrokerDesktopGroup "MyDesktop"-PowerOffDelay 15
```

Configure a time period during which the power-off delay does not take effect

- Suppose you want the power-off delay to take effect until 30 minutes have elapsed for a delivery group whose name is “MyDesktop.” Use the `Set-BrokerDesktopGroup` PowerShell command. For example:

- C:\PS> Set-BrokerDesktopGroup "MyDesktop"-SettlementPeriodBeforeAutoShutDown 30.

Configure the **machine instance cost** setting

- Suppose you want to set the machine instance cost per hour to 0.2 dollars for a delivery group whose name is "MyDesktop." Use the `Set-BrokerDesktopGroup` PowerShell command. For example:

- PS C:\> Set-BrokerDesktopGroup "MyDesktop"-MachineCost 0.2

New-BrokerPowerTimeScheme

Creates a BrokerPowerTimeScheme for a delivery group. For more information, see <https://citrix.github.io/delivery-controller-sdk/Broker/New-BrokerPowerTimeScheme/>.

Example

Suppose you want to create a power time scheme for a delivery group whose UID value is 3. The new scheme covers the weekend, Monday, and Tuesday. The 8:00 AM to 6:30 PM time slot is defined as peak times for the days included in the scheme. For peak times, the pool size (the number of machines kept powered on) is 20. For off-peak times, it is 5. You can use the `Set-BrokerDesktopGroup` PowerShell command. For example:

- PS C:\> \$ps48=(0..47 | %{ if (\$_ -lt 16 -or \$_ -gt 37){ 5 } else { 20 } })
- PS C:\> \$pt48=(0..47 | %{ if (\$_ -lt 16 -or \$_ -gt 37){ \$false } else { \$true } })
- PS C:\> New-BrokerPowerTimeScheme -Name 'First Half Week'-DaysOfWeek Weekend,Monday,Tuesday -DesktopGroupUid 3 -PeakHalfHours \$pt48 -PoolSize \$ps48

Parameters for dynamic session timeouts

The following Broker PowerShell SDK cmdlets have been extended for dynamic session timeouts by supporting multiple new parameters:

- Get-BrokerDesktopGroup
- New-BrokerDesktopGroup
- Set-BrokerDesktopGroup

Those parameters include:

- **DisconnectPeakIdleSessionAfterSeconds**—Represents the time in seconds after which an idle session is disconnected during peak time. This property has a default value of 0, which indicates the disablement of its associated behavior during peak time. A value greater than 0 enables its behavior for the delivery group during peak time only.
- **DisconnectOffPeakIdleSessionAfterSeconds** - Represents the time in seconds after which an idle session is disconnected during off-peak hours. The default value of this property is 0, which indicates the disablement of its associated behavior during off-peak. A value greater than 0 enables its associated behavior for the delivery group during off-peak hours only.
- **LogoffPeakDisconnectedSessionAfterSeconds** - Represents the time in seconds after which a disconnected session is terminated during peak time. The default value of this property is 0, which indicates the disablement of its associated behavior during peak time. A value greater than 0 enables its associated behavior for the delivery group during peak time only.
- **LogoffOffPeakDisconnectedSessionAfterSeconds** - Represents the time in seconds after which a disconnected session is terminated during off-peak hours. The default value of this property is 0, which indicates the disablement of its associated behavior during off-peak. A value greater than 0 enables its associated behavior for the delivery group during off-peak hours only.

Example

Suppose you want to set the idle session timeout to 3,600 seconds during peak times for a delivery group whose name is “MyDesktop.” Use the `Set-BrokerDesktopGroup` PowerShell command. For example:

- ```
C:\PS> Set-BrokerDesktopGroup "MyDesktop"-DisconnectOffPeakIdleSessionAfter
3600
```

Doing that disconnects sessions that have been idle for more than 1 hour in off-peak for the desktop group whose name is “MyDesktop.”

## Citrix Insight Services

January 26, 2024

Citrix Insight Services (CIS) is a Citrix platform for instrumentation, telemetry, and business insight generation. Its instrumentation and telemetry capabilities enable technical users (customers, partners, and engineers) to self-diagnose and fix problems and optimize their environments. For details

and the latest information about CIS and how it works, see <https://cis.citrix.com> (Citrix account credentials required).

All information uploaded to Citrix is used for troubleshooting and diagnostic purposes, and improving the quality, reliability, and performance of products, subject to:

- Citrix Insight Services Policy at <https://cis.citrix.com/legal>
- Citrix Privacy Policy at <https://www.citrix.com/about/legal/privacy.html>

This Citrix Virtual Apps and Desktops release supports the following technologies.

- Citrix Virtual Apps and Desktops install and upgrade analytics
- Citrix Customer Experience Improvement Program (CEIP)
- Citrix Call Home
- [Citrix Scout](#)

In addition to (and separate from) CIS and Citrix Analytics: Google Analytics are collected (and later uploaded) automatically when you install (or upgrade) Studio. After installing Studio, you can change this setting with the registry key HKLM\Software\Citrix\DesktopStudio\GAEnabled. A value of 1 enables collection and upload, 0 disables collection and upload.

## Install and upgrade analytics

When you use the full-product installer to deploy or upgrade Citrix Virtual Apps and Desktops components, anonymous information about the installation process is gathered and stored on the machine where you are installing/upgrading the component. This data is used to help Citrix improve its customers' installation experiences.

The information is stored locally under %ProgramData%\Citrix\CTQs.

Automatic upload of this data is enabled by default in both the graphical and command line interfaces of the full-product installer.

- You can change the default value in a registry setting. If you change the registry setting before installing/upgrading, that value is used when you use the full-product installer.
- You can override the default setting if you install/upgrade with the command line interface by specifying an option with the command.

### Control automatic uploads:

- Registry setting that controls automatic upload of install/upgrade analytics (default = 1):
  - Location: HKLM:\Software\Citrix\MetaInstall
  - Name: SendExperienceMetrics
  - Value: 0 = disabled, 1 = enabled

- Using PowerShell, the following cmdlet disables automatic upload of install/upgrade analytics:

```
1 New-ItemProperty -Path HKLM:\SOFTWARE\Citrix\MetaInstall -Name
 SendExperienceMetrics -PropertyType DWORD -Value 0
2 <!--NeedCopy-->
```

- To disable automatic uploads with the XenDesktopServerSetup.exe or XenDesktopV-DASetup.exe command, include the `/disableexperiencemetrics` option.

To enable automatic uploads with the XenDesktopServerSetup.exe or XenDesktopV-DASetup.exe command, include the `/sendexperiencemetrics` option.

## Citrix Customer Experience Improvement Program

When you participate in the Citrix Customer Experience Improvement Program (CEIP), anonymous statistics and usage information are sent to Citrix to help Citrix improve the quality and performance of Citrix products. For more information, see <https://more.citrix.com/XD-CEIP>.

### Enrollment during Site creation or upgrade

You are automatically enrolled in CEIP when you create a Site (after you install the first Delivery Controller). The first upload of data occurs approximately seven days after you create the Site.

You can stop your participation at any time after creating the Site. Select the **Settings** node in the Web Studio left pane and turn off the **Citrix Customer Experience Improvement Program** setting.

When you upgrade a Citrix Virtual Apps and Desktops deployment:

- If you upgrade from a version that did not support CEIP, you are asked if you want to participate.
- If you upgrade from a version that supported CEIP, and participation was enabled, CEIP is enabled in the upgraded Site.
- If you upgrade from a version that supported CEIP, and participation was disabled, CEIP is disabled in the upgraded Site.
- If you upgrade from a version that supported CEIP, and participation is unknown, you are asked if you want to participate.

The collected information is anonymous, so it cannot be viewed after it is uploaded to Citrix Insight Services.

### Enrollment when installing a VDA

By default, you are automatically enrolled in CEIP when you install a Windows VDA. You can change this default in a registry setting. If you change the registry setting before installing the VDA, that value is used.

Registry setting that controls automatic enrolment in CEIP (default = 1):

Location: HKLM: \Software\Citrix\Telemetry\CEIP

Name: Enabled

Value: 0 = disabled, 1 = enabled

By default, the `Enabled` property is hidden in the registry. When it remains unspecified, the automatic upload feature is enabled.

Using PowerShell, the following cmdlet disables enrollment in CEIP:

```
1 New-ItemProperty -Path HKLM:\SOFTWARE\Citrix\Telemetry\CEIP -Name
 Enabled -PropertyType DWORD -Value 0
2 <!--NeedCopy-->
```

The collected runtime datapoints are periodically written as files to an output folder (default %programdata%/Citrix/VdaCeip).

The first upload of data occurs approximately seven days after you install the VDA.

### Enrollment when installing other products and components

You can also participate in CEIP when you install related Citrix products, components, and technologies, such as Citrix Provisioning, AppDNA, Citrix License Server, Citrix Workspace app for Windows, Universal Print Server, and Session Recording. See their documentation for details about installation and participation default values.

### Citrix Call Home

When you install certain components and features in Citrix Virtual Apps and Desktops, you are offered the opportunity to participate in Citrix Call Home. Call Home collects diagnostic data and then periodically uploads telemetry packages containing that data directly to Citrix Insight Services (via HTTPS on default port 443) for analysis and troubleshooting.

In Citrix Virtual Apps and Desktops, Call Home runs as a background service under the name Citrix Telemetry Service. For more information, see <https://more.citrix.com/XD-CALLHOME>.

The Call Home scheduling functionality is also available in Citrix Scout. For details, see [Citrix Scout](#).

### What is collected

Citrix Diagnostic Facility (CDF) tracing logs information that can be useful for troubleshooting. Call Home collects a subset of CDF traces that can be helpful when troubleshooting common failures, for

example, VDA registrations and application/desktop launches. This technology is known as always-on tracing (AOT). AOT logs are saved to disk at C:\Users\CitrixTelemetryService\AppData\Local\CitrixAOT.

Call Home does not collect any other Event Tracing for Windows (ETW) information, nor can it be configured to do so.

Call Home also collects other information, such as:

- Registries created by Citrix Virtual Apps and Desktops under [HKEY\\_LOCAL\\_MACHINE\SOFTWARE\Citrix](#).
- Windows Management Instrumentation (WMI) information under the Citrix namespace.
- List of processes running.
- Crash dumps of Citrix processes that are stored in %PROGRAM DATA%\Citrix\CDF.
- Installation and upgrade information. This can include the full product metainstaller log, failing MSI logs, output from the MSI log analyzer, StoreFront logs, Licensing compatibility check logs, and results from preliminary site upgrade tests.

The trace information is compressed as it is collected. The Citrix Telemetry Service retains a maximum of 10 MB of compressed recent trace information, with a maximum time limit of eight days.

- Compressing data allows Call Home to maintain a small footprint on the VDA.
- Traces are held in memory to avoid IOPs on provisioned machines.
- The trace buffer uses a circular mechanism to retain traces in memory.

Call Home collects the key datapoints listed in [Call Home key datapoints](#).

### **Configure and manage summary**

You can enroll in Call Home when using the full-product installation wizard or later, using PowerShell cmdlets. When you enroll, by default, diagnostics are collected and uploaded to Citrix every Sunday at approximately 3:00 AM, local time. The upload is randomized with a two hour interval from the specified time. This means an upload using the default schedule occurs between 3:00 AM and 5:00 AM.

If you do not want to upload diagnostic information on a scheduled basis (or if you want to change a schedule), you can use PowerShell cmdlets to manually collect and upload diagnostics or store them locally.

When you enroll in scheduled Call Home uploads and when you manually upload diagnostic information to Citrix, you provide Citrix account or Citrix Cloud credentials. Citrix exchanges the credentials for an upload token that is used to identify the customer and upload the data. The credentials are not saved.

When an upload occurs, a notification is emailed to the address associated with the Citrix account.

If you enable Call Home when you install a component, you can disable it later.

## Prerequisites

- The machine must be running PowerShell 3.0 or later.
- The Citrix Telemetry Service must be running on the machine.
- The system variable `PSModulePath` must be set to Telemetry's install path, for example, `C:\Program Files\Citrix\Telemetry Service\`.

## Enable Call Home during component installation

**During VDA installation or upgrade:** When you install or upgrade a Virtual Delivery Agent using the graphical interface in the full-product installer, you are asked if you want to participate in Call Home. There are two options:

- Participate in Call Home.
- Do not participate in Call Home.

If you're upgrading a VDA and previously enrolled in Call Home, that wizard page does not appear.

**During Controller installation or upgrade:** When you install or upgrade a Delivery Controller using the graphical interface, you are asked if you want to participate in Call Home. There are three options:

When you're installing a Controller, you cannot configure information on the Call Home page in the installation wizard if that server has an Active Directory GPO with the policy setting "Log on as a service" applied. For details, see [CTX218094](#).

If you're upgrading a Controller and previously enrolled in Call Home, you're not asked about participating.

## PowerShell cmdlets

The PowerShell help provides comprehensive syntax, including descriptions of cmdlets and parameters that are not used in these common use cases.

To use a proxy server for uploads, see [Configure a proxy server](#).

- **Enable scheduled uploads:** Diagnostic collections are automatically uploaded to Citrix. If you do not enter additional cmdlets for a custom schedule, the default schedule is used.

```
1 $cred = Get-Credential
2 Enable-CitrixCallHome -Credential $cred
3 <!--NeedCopy-->
```

To confirm that scheduled uploads are enabled, enter `Get-CitrixCallHomeGet-CitrixCallHome`. If enabled, the return is `IsEnabled=True` and `IsMasterImage=False`.

- **Enable scheduled uploads for machines created from a master image:** Enabling scheduled uploads in a master image eliminates having to configure each machine that is created in the machine catalog.

```
Enable-CitrixCallHome -Credential $cred -MasterImage
```

To confirm that scheduled uploads are enabled, enter **Get-CitrixCallHome**. If enabled, the return is `IsEnabled=True` and `IsMasterImage=True`.

- **Create a custom schedule:** Create a daily or weekly schedule for diagnostic collections and uploads.

```
1 $timespan = New-TimeSpan -Hours hours -Minutes minutes
2 Set-CitrixCallHomeSchedule -TimeOfDay $timespan -DayOfWeek day
 -UploadFrequency {
3 Daily|Weekly }
4
5 <!--NeedCopy-->
```

### Examples:

The following cmdlet creates a schedule to bundle and upload data at 10:20 every evening. The Hours parameter uses a 24-hour clock. When the `UploadFrequency` parameter value is `Daily`, the `DayOfWeek` parameter is ignored, if specified.

```
1 $timespan = New-TimeSpan -Hours 22 -Minutes 20
2 Set-CitrixCallHomeSchedule -TimeOfDay $timespan -UploadFrequency Daily
3 <!--NeedCopy-->
```

To confirm the schedule, enter `Get-CitrixCallHomeSchedule`. In the preceding example, it returns `StartTime=22:20:00`, `DayOfWeek=Sunday` (ignored), `Upload Frequency=Daily`.

The following cmdlet creates a schedule to bundle and upload data at 10:20 every Wednesday evening.

```
1 $timespan = New-TimeSpan -Hours 22 -Minutes 20
2 Set-CitrixCallHomeSchedule -TimeOfDay $timespan -DayOfWeek Wed -
 UploadFrequency Weekly
3 <!--NeedCopy-->
```

To confirm the schedule, enter `Get-CitrixCallHomeSchedule`. In the preceding example, it returns `StartTime=22:20:00`, `DayOfWeek=Wednesday`, `Upload Frequency=Weekly`.

## Disable Call Home

You can disable Call Home using a PowerShell cmdlet or through Citrix Scout.

AOT logs are collected and saved to disk, even when Call Home scheduled uploads are disabled. (When scheduled uploads are disabled, AOT logs are not automatically uploaded to Citrix.) You can disable the collection and local storage of AOT logs.

**Disable Call Home with PowerShell** After running the following cmdlet, diagnostic data will not be uploaded to Citrix automatically. (You can still upload diagnostic data using Citrix Scout or telemetry PowerShell cmdlets.)

```
Disable-CitrixCallHome
```

To confirm that Call Home is disabled, enter `Get-CitrixCallHome`. If disabled, the return is `IsEnabled=False` and `IsMasterImage=False`.

**Disable a collection schedule using Citrix Scout** To disable a diagnostic collection schedule using Citrix Scout, follow the guidance in [Schedule collections](#). In step 3, click **Off** to cancel the schedule for the selected machines.

**Disable collection of AOT logs** After running the following cmdlet (with the `Enabled` field set to `false`), AOT logs will not be collected.

```
Enable-CitrixTrace -Listen'{ "trace":{ "enabled":false,"persistDirectory": "C:\Users\Public", "maxSizeBytes":1000000, "sliceDurationSeconds":300 } } '
```

The `Listen` parameter contains arguments in JSON format.

## Configure a proxy server for Call Home uploads

Complete the following tasks on the machine where Call Home is enabled. Example diagrams in the following procedure contain server address and port 10.158.139.37:3128. Your information will differ.

1. Add proxy server information in your browser. In Internet Explorer, select **Internet Options > Connections > LAN settings**. Select **Use a proxy server for your LAN** and enter the proxy server address and port number.
2. In PowerShell, run `netsh winhttp import proxy source=ie`.



```
PS C:\Users\administrator.JLGXH> netsh winhttp import proxy source=ie
Current WinHTTP proxy settings:
Proxy Server(s) : 10.108.124.245:8080
Bypass List : (none)
```

- Using a text editor, edit the TelemetryService.exe config file, which is located in C:\Program Files\Citrix\Telemetry Service. Add the information shown in the red box.

```
TelemetryService.exe - Notepad
File Edit Format View Help
<?xml version="1.0" encoding="utf-8"?>
<configuration>
 <startup>
 <supportedRuntime version="v4.0" sku=".NETFramework,Version=v4.5.1" />
 </startup>
 <runtime>
 <assemblyBinding xmlns="urn:schemas-microsoft-com:asm.v1">
 <dependentAssembly>
 <assemblyIdentity name="Newtonsoft.Json" culture="neutral" publicKeyToken="30ad4fe6b2a6aeed" />
 <bindingRedirect oldVersion="0.0.0.0-9.0.0.0" newVersion="9.0.0.0" />
 </dependentAssembly>
 <probing privatePath="TelemetryModule" />
 </assemblyBinding>
 </runtime>
 <system.net>
 <defaultProxy>
 <proxy bypassonlocal="false" usesystemdefault="true" proxyaddress="http://10.108.124.245:8080" />
 </defaultProxy>
 </system.net>
</configuration>
```

- Restart the Telemetry Service.

Run the Call Home cmdlets in PowerShell.

### Manually collect and upload diagnostic information

You can use the CIS website to upload a diagnostic information bundle to CIS. You can also use PowerShell cmdlets to collect and upload diagnostic information to CIS.

To upload a bundle using the CIS website:

- Log on to Citrix Insight Services using your Citrix account credentials.
- Select **My Workspace**.
- Select **Healthcheck** and then navigate to the location of your data.

CIS supports several PowerShell cmdlets that manage data uploads. This documentation covers the cmdlets for two common cases:

- Use the `Start-CitrixCallHomeUpload` cmdlet to manually collect and upload a diagnostic information bundle to CIS. (The bundle is not saved locally.)

- Use the `Start-CitrixCallHomeUpload` cmdlet to manually collect data and store a diagnostic information bundle locally. This allows you to preview the data. Later, use the `Send-CitrixCallHomeBundle` cmdlet to manually upload a copy of that bundle to CIS. (The data you originally saved remains locally.)

The PowerShell help provides comprehensive syntax, including descriptions of cmdlets and parameters that are not used in these common use cases.

When you enter a cmdlet to upload data to CIS, you are prompted to confirm the upload. If the cmdlet times out before the upload completes, check the status of the upload in the system event log. The upload request might be rejected if the service is already performing an upload.

#### Collect data and upload bundle to CIS:

```
1 Start-CitrixCallHomeUpload [-Credential] PSCredential [-InputPath
 string] [-Description string] [-IncidentTime string] [-SRNumber
 string] [-Name string] [-UploadHeader string] [-AppendHeaders string
] [-Collect string] [<CommonParameters>]
2 <!--NeedCopy-->
```

#### Collect data and save it locally:

```
1 Start-CitrixCallHomeUpload -OutputPath <String> [-InputPath string] [-
 Description string] [-IncidentTime string] [-SRNumber string] [-Name
 string] [-UploaderHeader string] [-AppendHeaders string] [-Collect
 strings] [<CommonParameters>]
2 <!--NeedCopy-->
```

The following parameters are valid:

- **Credential:** Directs the upload to CIS.
- **InputPath:** Location of zip file to include in the bundle. This might be an additional file that Citrix Support requests. Be sure to include the .zip extension.
- **OutputPath:** Location where the diagnostic information is saved. This parameter is required when saving Call Home data locally.
- **Description and Incident Time:** Free form information about the upload.
- **SRNumber:** Citrix Technical Support incident number.
- **Name:** Name that identifies the bundle.
- **UploadHeader:** JSON-formatted string specifying the upload headers uploaded to CIS.
- **AppendHeaders:** JSON-formatted string specifying the appended headers uploaded to CIS.
- **Collect:** JSON-formatted string specifying which data to collect or omit, in the form {'collector': {'enabled': Boolean}}, where Boolean is true or false.

Valid collector values are:

- 'wmi'
- 'process'
- 'registry'
- 'crashreport'
- 'trace'
- 'file'
- 'msi'
- 'localdata'
- 'sitedata'
- 'sfb'

By default, all collectors except 'sfb' are enabled.

The 'sfb' collector is designed to be used on demand to diagnose Skype for Business issues. In addition to the 'enabled' parameter, the 'sfb' collector supports the 'account' and 'accounts' parameters to specify target users. Use one of the forms:

- "-Collect "{sfb}:{account}:'domain\\user1'}"}"
- "-Collect "{sfb}:{accounts}:['domain\\user1', 'domain\\user2']}"}"

- **Common Parameters:** See the PowerShell help.

#### Upload data that was previously saved locally:

```
Send-CitrixCallHomeBundle -Credential <PSCredential> -Path string [<CommonParameters>]
```

The `Path` parameter specifies the location of the previously saved bundle.

#### Examples:

The following cmdlet requests an upload of Call Home data (excluding data from the WMI collector) to CIS. This data relates to registration failures of Citrix Provisioning VDAs, which were noted at 2:30 PM for Citrix Support case 123456. In addition to the Call Home data, the file "c:\Diagnostics\ExtraData.zip" is incorporated into the uploaded bundle.

```
1 C:\PS>Start-CitrixCallHomeUpload -InputPath "c:\Diagnostics\ExtraData.zip" -Description "Registration failures with Citrix Provisioning VDAs" -IncidentTime "14:30" -SRNumber 123456 -Name "RegistrationFailure-021812016" -Collect "{
2 'wmi':{
3 'enabled':false }
4 }
5 " -UploadHeader "{
6 'key1':'value1' }
7 " -AppendHeaders "{
8 'key2':'value2' }
9 "
10 <!--NeedCopy-->
```

The following cmdlet saves Call Home data related to Citrix Support case 223344, noted at 8:15 AM. The data saved in the file mydata.zip on a network share. In addition to the Call Home data, the file “c:\Diagnostics\ExtraData.zip” will be incorporated into the saved bundle.

```
1 C:\PS\>Start-CitrixCallHomeUpload -OutputPath \\mynetwork\myshare\
 mydata.zip -InputPath "c:\Diagnostics\ExtraData.zip" -Description "
 Diagnostics for incident number 223344" -IncidentTime "8:15" -
 SRNumber 223344
2 <!--NeedCopy-->
```

The following cmdlet uploads the data bundle you saved earlier.

```
1 $cred=Get-Credential
2 C:\PS>Send-CitrixCallHomeBundle -Credential $cred -Path \\mynetwork\
 myshare\mydata.zip
3 <!--NeedCopy-->
```

## Citrix Scout

February 24, 2023

### Introduction

Citrix Scout collects diagnostics and runs health checks. You can use the results to maintain your Citrix Virtual Apps and Desktops deployment. Citrix offers comprehensive, automated analysis of diagnostics collections through Citrix Insight Services. You can also use Scout to troubleshoot issues, on your own or with Citrix Support guidance.

You can upload collection files to Citrix for analysis and guidance from Citrix Support. Or, you can save a collection locally for your own review, and then later upload the collection file to Citrix for analysis.

Scout offers the following procedures:

- **Collect:** Runs a one-time diagnostics collection on machines you select in a site. You can then either upload the file to Citrix or save it locally.
- **Trace & Reproduce:** Starts a manual trace on the machines you select. Then you re-create issues on those machines. After re-creating the issue, the trace is stopped. Scout then collects other diagnostics and uploads the file to Citrix, or saves the file locally.
- **Schedule:** Schedules diagnostics collections to occur daily or weekly at a specified time on the machines you select. The file is automatically uploaded to Citrix.
- **Health Check:** Runs checks that gauge the health and availability of the site and its components. You can run health checks for Delivery Controllers, Virtual Delivery Agents (VDAs), Store-Front servers, and Citrix License Servers. If issues are found during the checks, Scout provides

a detailed report. Each time Scout starts, it checks for updated health check scripts. If new versions are available, Scout downloads them automatically, for use the next time health checks are run.

**Note:**

The **Trace & Reproduce**, **Schedule**, and **Health Check** procedures are currently not available for Linux VDA.

The graphical interface described in this article is the primary way to use Scout. Alternatively, you can use PowerShell to configure one-time or scheduled diagnostic collections and uploads. See [Call Home](#).

Where to run Scout:

- In an on-premises deployment, run Scout from a Delivery Controller to capture diagnostics or run checks on one or more Virtual Delivery Agents (VDAs), Delivery Controllers, StoreFront servers, and License Servers. You can also run Scout from a VDA to collect local diagnostics.
- In a Citrix Cloud environment that uses Citrix DaaS (formerly Citrix Virtual Apps and Desktops service), run Scout from a VDA to collect local diagnostics.

The log for the Scout application is stored in `C:\ProgramData\Citrix\TelemetryService\ScoutUI.log`. This file can be used for troubleshooting.

## What is collected

The diagnostics collected by Scout include Citrix Diagnostic Facility (CDF) trace log files. A subset of CDF traces called Always-on Tracing (AOT) is also included. AOT information can be helpful when troubleshooting common issues such as VDA registrations and application/desktop launches. No other Event Tracing for Windows (ETW) information is collected.

The collection includes:

- Registry entries created by Citrix Virtual Apps and Desktops under `HKEY_LOCAL_MACHINE\SOFTWARE\Citrix`.
- Windows Management Instrumentation (WMI) information under the **Citrix namespace**.
- Processes that are running.
- Crash dumps of Citrix processes that are stored in `%PROGRAMDATA%\Citrix\CDF`.
- Citrix policy information, in CSV format.
- Installation and upgrade information. The collection can include the full product metainstaller log, failing MSI logs, output from the MSI log analyzer, StoreFront logs, Licensing compatibility check logs, and results from preliminary site upgrade tests.

About trace information:

- The trace information is compressed as it is collected, keeping a small footprint on the machine.
- On each machine, the Citrix Telemetry Service keeps compressed recent trace information for a maximum of eight days.
- Beginning with Citrix Virtual Apps and Desktops 7 1808, AOT traces are saved to the local disk by default. (In earlier versions, traces were held in memory.) Default path = `C:\Users\CitrixTelemetryService\AppData\Local\CitrixAOT`.
- Beginning with Citrix Virtual Apps and Desktops 7 1811, AOT traces saved to network shares are collected with other diagnostics.
- You can modify the maximum size (default = 10 MB) and slice duration, using the `Enable-CitrixTrace` cmdlet or the `HKEY_LOCAL_MACHINE\SOFTWARE\Citrix\TelemetryDefaultListen` registry string.
- Traces append to the file until the file reaches 10% of `MaxSize`.

For a list of the datapoints that Scout collects, see [Call Home key datapoints](#).

## Scout configuration

Scout can be configured to work on Linux VDAs. For more information on Linux VDA and telemetry, see [Integrate with the Citrix Telemetry Service](#)

The Linux VDA might automatically change the `ctxtelemetry` socket port or the port for telemetry service. If so, you must configure the port manually.

1. Navigate to `C:\Program Files\Citrix\Telemetry Service`
2. Open the `ScoutUI.exe.config` file.
3. Change the value for `LinuxVDATElemetryServicePort` or `LinuxVDATElemetryWakeupPort` to what was configured on the Linux VDA:

- `<add key="LinuxVDATElemetryServicePort" value="7502"/>`
- `<add key="LinuxVDATElemetryWakeupPort" value="7503"/>`

1. Save the changes and close the file.
2. Open Scout again to ensure it loads the latest configuration.

## About health checks

Health check data is stored in folders under `C:\ProgramData\Citrix\TelemetryService\`

## Site health checks

Site health checks are included in the Environment Test Service, which provides a comprehensive evaluation of the FlexCast Management Architecture (FMA) services. In addition to checking for service availability, these checks look for other health indicators such as database connections.

Site health checks run on Delivery Controllers. Depending on your site's size, these checks can take up to an hour to complete.

**Delivery Controller configuration checks** As part of the site health checks. Delivery Controller configuration checks verify whether the following issues exist, based on Citrix recommendations for Virtual Apps and Desktops sites:

- One or more Delivery Controllers are in a failed state.
- There is only one Delivery Controller in the site.
- Delivery Controllers are of different versions.

In addition to meeting the permissions and requirements for health checks, Delivery Controller configuration checks require:

- At least one Controller powered on.
- The Broker Service running on a Controller.
- A working connection from the Controller to the site database.

## VDA health checks

VDA health checks identify possible causes for common VDA registration, session launch, and time zone redirection issues.

For registration on the VDA, Scout checks:

- VDA software installation
- VDA machine domain membership
- VDA communication port availability
- VDA service status
- Windows firewall configuration
- Communication with Controller
- Time sync with Controller
- VDA registration status

For session launches on VDAs, Scout checks:

- Session launch communication port availability

- Session launch services status
- Session launch Windows firewall configuration
- VDA Remote Desktop Services Client Access Licenses
- VDA application launch path
- Session launch registry settings

For time zone redirection on VDAs, Scout checks:

- Windows hotfix installation
- Citrix hotfix installation
- Microsoft group policy settings
- Citrix group policy settings

For Profile Management on VDAs, Scout checks:

- Hypervisor detection
- Provisioning detection
- Citrix Virtual Apps and Desktops
- Personal vDisk configuration
- User store
- Profile Management Service status detection
- Winlogon.exe hooking test

To run checks on Profile Management, you must install and enable Profile Management on the VDA. For more information on Profile Management configuration checks, see Knowledge Center article [CTX132805](#).

### **StoreFront health checks**

StoreFront checks verify:

- Citrix Default Domain service is running
- Citrix Credential Wallet service is running
- Connection from the StoreFront server to Active Directory port 88
- Connection from the StoreFront server to Active Directory port 389
- Base URL has a valid FQDN
- Correct IP address from the base URL can be retrieved
- IIS application pool is using .NET 4.0
- Whether the certificate is bound to the SSL port for the host URL
- Whether the certificate chain is complete
- Whether the certificates have expired
- Whether a certificate is expiring soon (within 30 days)



## License Server checks

License Server checks verify:

- License Server connection from the Delivery Controller
- License Server firewall remote access status
- Citrix Licensing service status
- License Server grace period state
- License Server ports connection
- Whether the Citrix vendor daemon (CITRIX) is running
- Whether system clocks are synchronized
- Whether the Citrix Licensing service is running under the Local Service account
- Presence of the `CITRIX.opt` file
- Customer Success Services eligibility date
- Citrix License Server Update
- Whether the License Server certificate is in the Delivery Controller's trusted root store

In addition to meeting the permissions and requirements for health checks, the License Server must be joined to a domain. Otherwise, the License Server is not discovered.

## Run health checks

The Health Check procedure comprises selecting machines, starting the checking, and then reviewing the results report.

1. Launch Scout. From the machine's **Start** menu, select **Citrix > Citrix Scout**. On the opening page, click **Health Check**.
2. Select machines. Click **Find machine** to discover machines. The **Select machines** page lists all the VDAs, Delivery Controllers, and License Servers discovered in the site. You can filter the display by machine name. Select the check box next to each machine you want to collect diagnostics from, and then click **Continue**.

To add other component types (such as StoreFront servers and VDA machines), see Add machines manually and Import VDA machines. You cannot manually add Citrix Provisioning Servers or License Servers.

Scout automatically launches verification tests on each selected machine, making sure it meets the criteria listed in Verification tests. If verification fails, a message is posted in the **Status** column, and that machine's check box is cleared. You can either:

- Resolve the issue and then select the machine's check box again. This triggers a retry of the verification tests.

- Skip that machine (leave its check box unselected). Health checks are not run for that machine.

When the verification tests complete, click **Continue**.

3. Run the health checks on the selected machines. The summary lists the machines where the tests run (the machines you selected that passed the verification tests). Click **Start Checking**.

During and after checking:

- The **Status** column indicates the current checking state for a machine.
  - To stop all in-progress checks, click **Stop Checking** in the lower right corner of the page. (You can't cancel a single machine's health check, only all selected machines. Information from machines that have completed the checks is kept.)
  - When the checks complete for all selected machines, the **Stop Checking** button in the lower right corner changes to **Done**.
  - If a check fails, you can click **Retry** in the **Action** column.
  - If a check completes with no issues found, the **Action** column is empty.
  - If a check finds issues, click **View Details** to show the results.
  - After the check completes for all selected machines, don't click **Back**. (If you do, the check results are lost.)
4. When the checks complete, click **Done** to return to the Scout opening page.

## Health check results

For report-generating Citrix checks, the reports contain:

- Time and date when the results report was generated
- Machines that were checked
- Conditions that the check looked for on the targeted machines

## Permissions and requirements

Permissions:

- To collect diagnostics:
  - You must be a local administrator and domain user for each machine from which you're collecting diagnostics.
  - You must have permission to write to the LocalAppData directory on each machine.
- To run health checks:

- You must be a member of the domain users group.
  - You must be either a full administrator or have a custom role with read-only and **Run Environment Tests** permissions for the site.
  - Set the script execution policy to at least `RemoteSigned` to allow the scripts to run. For example: `Set-ExecutionPolicy RemoteSigned`. **Note:** other script execution privileges can work as well.
- Use **Run as administrator** when launching Scout.

For each machine from which you collect diagnostics or run health checks:

- Scout must be able to communicate with the machine.
- File and printer sharing must be turned on.
- PSRemoting and WinRM must be enabled. The machine must also be running PowerShell 3.0 or later.
- The Citrix Telemetry Service must be running on the machine.
- Windows Management Infrastructure (WMI) access must be enabled on the machine.
- To set a schedule for diagnostic collection, the machine must be running a compatible Scout version.

Do not use the dollar sign (\$) in user names specified in pathnames. It prevents the collection of diagnostic information.

Scout runs verification tests on the machines you select, to make sure these requirements are met.

The Telemetry Service for Windows runs on Network Service.

|                                   |                  |         |                 |                     |
|-----------------------------------|------------------|---------|-----------------|---------------------|
| Citrix Remote Broker Provider     | Enables co...    | Running | Automatic       | Network Service     |
| Citrix Storefront Privileged ...  | Manages pr...    | Running | Automatic       | NT AUTHORITY\SYSTEM |
| Citrix Storefront Service         | Manages de...    | Running | Automatic       | Network Service     |
| Citrix Telemetry Service          | Citrix Telem...  | Running | Automatic (D... | Network Service     |
| Citrix Trust Service              | Citrix Trust ... | Running | Automatic       | Network Service     |
| Citrix Web Services for Lice...   | A service th...  | Running | Automatic       | Local Service       |
| Citrix XenServer Installation ... | Installs and ... |         | Manual          | Local System        |
| Citrix XenServer Windows ...      | Monitors an...   | Running | Automatic       | Local System        |

The AOT Trace Folder is saved in `C:\ProgramData\Citrix\TelemetryService\CitrixAOT`.

Only users in the Administrator group, System, and Telemetry Service SID have permission to access the `HKEYLOCALMACHINE:SOFTWARE\Citrix\Telemetry` registry.

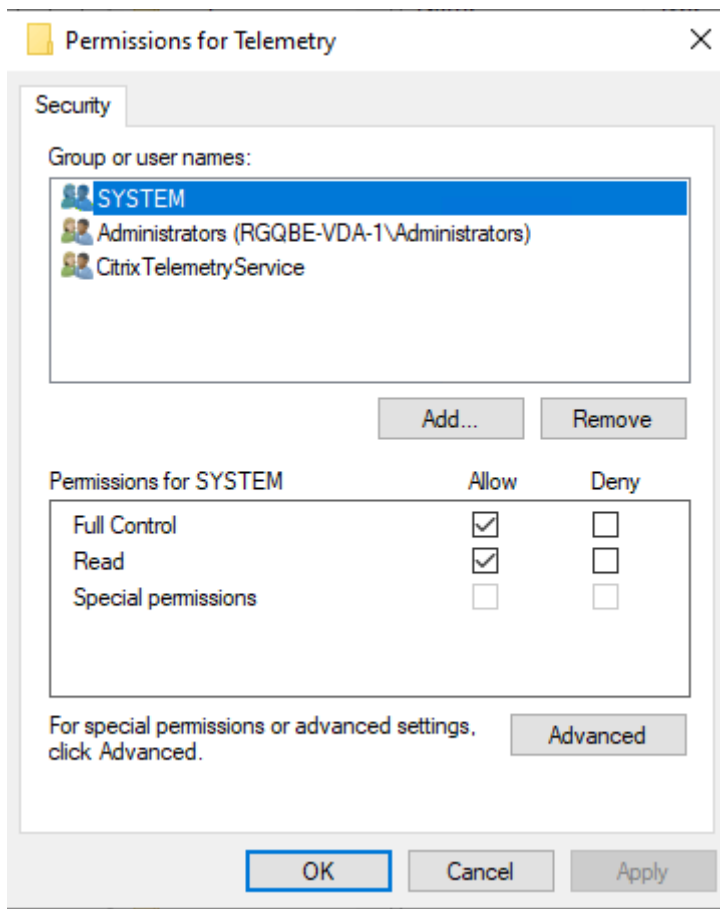

The Telemetry Service SID remains in the Performance Log Users group after uninstalling Telemetry Service, but you can remove it manually.

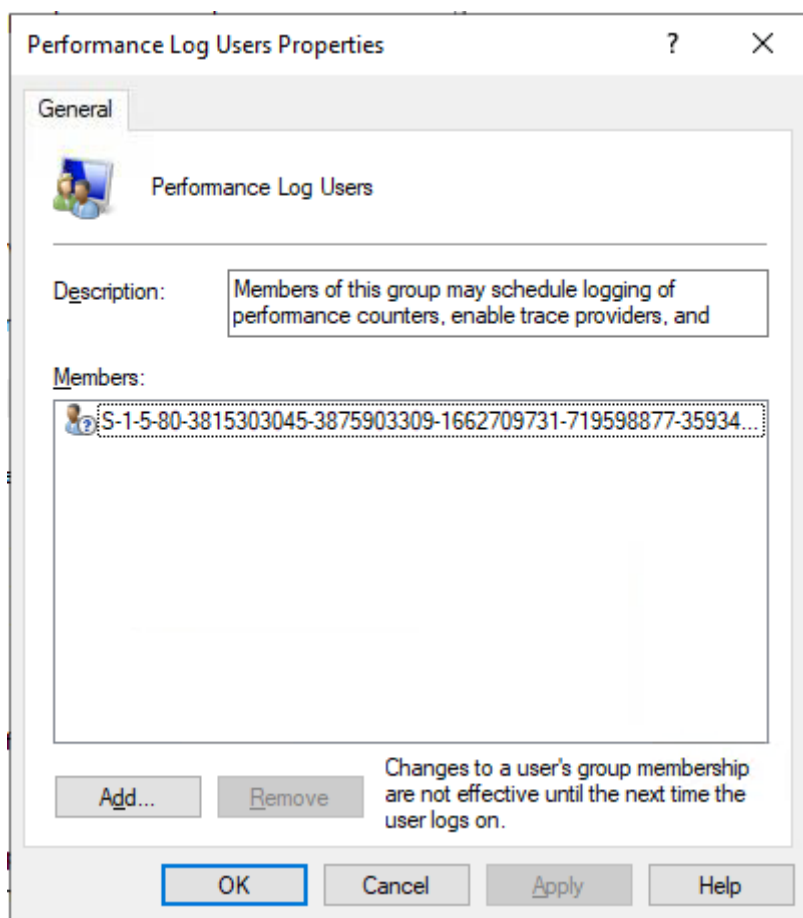

## Verification tests

Before a diagnostic collection or health check starts, verification tests run automatically for each selected machine. These tests make sure that the requirements are met. If a test fails for a machine, Scout displays a message, with suggested corrective actions.

- **Scout cannot reach this machine** - Ensure that:
  - The machine is powered-on.
  - The network connection is working properly. (This can include verifying that your firewall is properly configured.)
  - File and printer sharing is turned on. See the Microsoft documentation for instructions.
- **Enable PSRemoting and WinRM** - You can enable PowerShell remoting and WinRM at the same time. Using **Run as administrator**, run the `Enable-PSRemoting` cmdlet. For details, see the Microsoft help for the cmdlet.
- **Scout requires PowerShell 3.0 (minimum)** - Install PowerShell 3.0 (or later) on the machine, and then enable PowerShell remoting.

- **Unable to access LocalAppData directory on this machine** - Ensure that account has permission to write to the LocalAppData directory on the machine.
- **Cannot locate Citrix Telemetry Service** - Ensure that the Citrix Telemetry Service is installed and started on the machine.
- **Cannot get schedule** - Upgrade the machine to (minimum) XenApp and XenDesktop 7.14.
- **WMI is not running on the machine** - Ensure that Windows Management Instrumentation (WMI) access is enabled.
- **WMI connections blocked** - Enable WMI in the Windows Firewall service.
- **Newer version of Citrix Telemetry Service required** - (Version is checked only for Collect and Trace & Reproduce.) Upgrade the Telemetry Service version on the machine (see Install and upgrade). If you do not upgrade the service, that machine is not included in the **Collect** or **Trace & Reproduce** actions.
- **Scout cannot connect to the systemd socket on this machine** - Ensure that:
  - Port 7503 is open. Verify that the systemd ctxtelemetry.socket is listening on port 7503 on the machine. The port might be different if the ctxtelemetry.socket port has been changed. See Scout configuration to adjust ports.
  - The network connection is working properly. (This might include verifying that your firewall is properly configured.)
- **The Linux VDA Telemetry Service is not started on this machine** - Ensure that:
  - Port 7502 is open. Verify that the Linux VDA Telemetry Service is installed and started on the machine. The port might be different if the telemetry service port has been changed. See Scout configuration to adjust ports.
  - The network connection is working properly. (This might include verifying that your firewall is properly configured.)

## Version compatibility

This version of Scout (3.x) is intended to be run on Citrix Virtual Apps and Desktops (or minimum XenApp and XenDesktop 7.14) Controllers and VDAs.

An earlier version of Scout is provided with XenApp and XenDesktop versions earlier than 7.14. For information about that earlier version, see [CTX130147](#).

If you upgrade a Controller or VDA earlier than 7.14 to version 7.14 (or a later supported version), the earlier version of Scout is replaced with the current version.

| Feature                                                                                 | Scout 2.23                             | Scout 3.0                                                                             |
|-----------------------------------------------------------------------------------------|----------------------------------------|---------------------------------------------------------------------------------------|
| Support Citrix Virtual Apps and Desktops (plus XenApp and XenDesktop 7.14 through 7.18) | Yes                                    | Yes                                                                                   |
| Support XenDesktop 5.x, 7.1–7.13                                                        | Yes                                    | No                                                                                    |
| Support XenApp 6.x, 7.5 to 7.13                                                         | Yes                                    | No                                                                                    |
| Delivered with product                                                                  | 7.1–7.13                               | Beginning with 7.14                                                                   |
| Can be downloaded from CTX article                                                      | Yes                                    | No                                                                                    |
| Capture CDF traces                                                                      | Yes                                    | Yes                                                                                   |
| Capture Always-on-Traces (AOT)                                                          | No                                     | Yes                                                                                   |
| Allow collection of diagnostic data                                                     | Up to 10 machines at once (by default) | Unlimited (subject to resource availability)                                          |
| Allow diagnostic data to be sent to Citrix                                              | Yes                                    | Yes                                                                                   |
| Allow diagnostic data to be saved locally                                               | Yes                                    | Yes                                                                                   |
| Support Citrix Cloud credentials                                                        | No                                     | Yes                                                                                   |
| Support Citrix credentials                                                              | Yes                                    | Yes                                                                                   |
| Support proxy server for uploads                                                        | Yes                                    | Yes                                                                                   |
| Adjust schedules                                                                        | N/A                                    | Yes                                                                                   |
| Script support                                                                          | Command line (local Controller only)   | PowerShell using Call Home cmdlets (any machine with the Telemetry Service installed) |
| Health checks                                                                           | No                                     | Yes                                                                                   |
| Data Masking                                                                            | No                                     | Beginning with 3.17                                                                   |

## Install and upgrade

By default, Scout is installed or upgraded automatically as part of the Citrix Telemetry Service when you install or upgrade a VDA or a Controller.

If you omit the Citrix Telemetry Service when you install a VDA, or remove the service later, run `TelemetryServiceInstaller_xx.msi` from the `x64\Virtual Desktop Components` or `x86\Virtual Desktop Components` folder on the Citrix Virtual Apps and Desktops installation media.

When you select the **Collect** or **Trace & Reproduce** action, you're notified if a machine is running an older version of the Citrix Telemetry Service. Citrix recommends using the latest supported version. If you don't upgrade the Telemetry Service on that machine, it is not included in the **Collect** or **Trace & Reproduce** actions. To upgrade the Telemetry Service, use the same procedure as installing it.

### Upload authorization

If you plan to upload diagnostic collections to Citrix, you must have a Citrix or Citrix Cloud account. (These are the credentials you use to access Citrix downloads or access the Citrix Cloud Control Center.) After your account credentials are validated, a token is issued.

If you authenticate with a Citrix account or a Citrix Cloud account, click a link to access Citrix Cloud using HTTPS with your default browser. After you enter your Citrix Cloud credentials, the token is displayed. Copy the token and then paste it into Scout. You can then continue in the Scout wizard.

The token is stored locally on the machine where you're running Scout. To enable use of that token the next time you run **Collect** or **Trace & Reproduce**, select the **Store token and skip this step in the future** check box.

You must reauthorize each time you select **Schedule** on the Scout opening page. You cannot use a stored token when creating or changing a schedule.

### Use a proxy for uploads

If you want to use a proxy server to upload collections to Citrix, you can instruct Scout to use the proxy settings configured for your browser's Internet Properties. Alternatively, you can specify the proxy server's IP address and port number.

### Find machine

For the **Collect**, **Trace & Reproduce**, and **Schedule** procedures, Scout lists the Controllers and VDAs it discovers automatically.

When you run Scout Health Check from Delivery Controller, click **Find machine** to discover machines, including delivery controllers, VDAs, license servers, and StoreFront servers.



When you run Scout Health Check from a domain-joined machine which is not Delivery Controller, Scout cannot discover machines automatically. You need to add machines manually or import VDA machines.

## Add machines manually

After Scout lists the Controllers and VDAs it discovers, you can manually add other machines in the deployment, such as StoreFront servers, License Servers, and Citrix Provisioning servers.

When running health checks:

- Citrix License Servers in the domain are discovered automatically. You cannot add License Servers manually.
- Health checks do not currently support Citrix Provisioning servers.

On any Scout page that lists the discovered machines, click **+ Add machine**. Type the FQDN of the machine you want to add, and then click **Continue**. Repeat to add other machines, as needed. (Although entering a DNS alias instead of an FQDN can appear valid, the health checks might fail.)

Manually added machines always appear at the top of the machines list, above the discovered machines.

An easy way to identify a manually added machine is the red delete button on the right end of the row. Only manually added machines have that button. Discovered machines don't.

To remove a manually added machine, click the red button on the right end of the row. Confirm the deletion. Repeat to delete other manually added machines.

Scout remembers manually added machines until you remove them. When you close and then reopen Scout, the manually added machines are still listed at the top of the list.

CDF traces are not collected when using **Trace & Reproduce** on StoreFront servers. However, all other trace information is collected.

## Import VDA machines

You can import VDA machines in the deployment when running health checks.

1. On Delivery Controller or Connector, generate the machine list file with the PowerShell command. On Connector, you must input Citrix credentials and select the customer in the pop-up dialog.

```
Get-BrokerMachine | foreach { $_.DnsName } | out-file C:\machineList.txt
```

2. Copy the machineList.txt file to the domain-joined machine you want to launch Scout Health Check.
3. On the Scout Health Check page, click **Add Machine**.
4. Select the **Windows VDA** machine type.
5. Click **Import VDA machines**.
6. Select the machineList.txt file.
7. Click **Open**.

The imported VDA machines are listed on the Scout Health Check page.

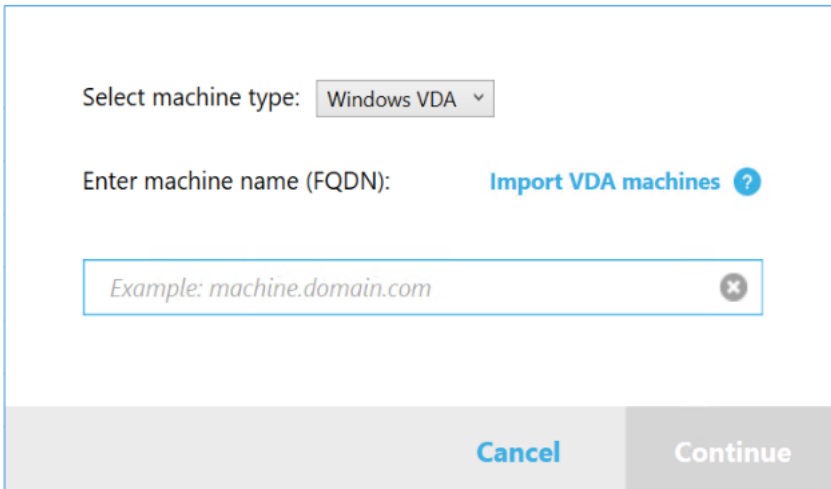

The screenshot shows a dialog box for importing VDA machines. It features a dropdown menu for 'Select machine type' with 'Windows VDA' selected. Below it is a text input field for 'Enter machine name (FQDN):' with a placeholder 'Example: machine.domain.com' and a blue 'Import VDA machines' button with a question mark icon. At the bottom, there are two buttons: 'Cancel' and 'Continue'.

## Collect diagnostics

The **Collect** procedure comprises selecting machines, starting the diagnostics collection, and then uploading the file containing the collection to Citrix or saving it locally.

1. Launch Scout. From the machine's **Start** menu, select **Citrix > Citrix Scout**. On the opening page, click **Collect**.
2. Select machines.
  - On a Controller, the **Select machines** page lists all the VDAs and Controllers in the site. You can filter the display by machine name. To add other machines manually (such as StoreFront or Citrix Provisioning servers), see Add machines manually.
  - On other components (such as VDA servers), the **Select machines** page lists only the local machine. Manually adding machines is not supported.

Select the check box next to each machine you want to collect diagnostics from, and then click **Continue**.

Scout automatically launches verification tests on each selected machine, ensuring it meets the criteria listed in Verification tests. If verification fails, a message is posted in the **Status** column, and that machine's check box is unselected. You can either:

- Resolve the issue and then select the machine's check box again. This triggers a retry of the verification tests.
- Skip that machine (leave its check box unselected). Diagnostics won't be collected from that machine.

When the verification tests complete, click **Continue**.

3. Collect diagnostics. The summary lists all the machines from which diagnostics are collected (the machines you selected that passed the verification tests). Click **Start Collecting**.

During collection:

- The **Status** column indicates the current collection state for a machine.
- To stop an in-progress collection on a single machine, click **Cancel** in the **Action** column for that machine.
- To stop all in-progress collections, click **Stop Collection** in the lower right corner of the page. Diagnostics from machines that have completed collection are kept. To resume the collection, click **Retry** in the **Action** column for each machine.
- When the collection completes for all selected machines, the **Stop Collection** button in the lower right corner changes to **Continue**.
- To collect diagnostics again, click **Collect Again** in that machine's **Action** column. The newer collection overwrites the earlier.
- If a collection fails, you can click **Retry** in the **Action** column. Only successful collections are uploaded or saved.
- After the collection completes for all selected machines, don't click **Back**. (If you click it, the collection is lost.)

When the collection completes, click **Continue**.

4. Save or upload the collection. Choose whether to upload the file to Citrix, or save it on the local machine.

If you choose to upload the file now, continue with Step 5.

If you choose to save the file locally:

- A Windows **Save** dialog box appears. Navigate to the desired location.
- When the local save completes, the pathname of the file is displayed and linked. You can view the file. You can upload the file later to Citrix. See [CTX136396](#).

Click **Done** to return to the Scout opening page. You don't need to complete any further steps in this procedure.

5. Authenticate for uploads and optionally specify a proxy. For details, see Upload authorization.

- If you haven't authenticated through Scout, continue with this step.
- If you have authenticated through Scout, the stored authorization token is used by default. If this is what you want to do, select this option and click **Continue**. You aren't prompted for credentials for this collection. Continue with Step 6.
- If you authenticated previously, but want to reauthorize and get a new token, click **Change/Reauthorize** and continue with this step.

Choose whether you want to use Citrix credentials or Citrix Cloud credentials to authenticate the upload. Click **Continue**. The credentials page appears only if you're not using a stored token.

On the credentials page:

- If you want to use a proxy server for the file upload, click **Configure proxy**. You can instruct Scout to use the proxy settings configured for your browser's internet properties. Or, you can enter the proxy server's IP address and port number. Close the proxy dialog box.
- For a Citrix Cloud account, click **Generate token**. Your default browser launches to a Citrix Cloud page where a token is displayed. Copy the token, and then paste it on the Scout page.
- For a Citrix account, enter your credentials.

When you're done, click **Continue**.

6. Enter information about the upload.

- The name field contains the default name for the file for the collected diagnostics. This suffices for most collections, although you can change the name. (If you delete the default name and leave the name field empty, the default name is used.)
- Optionally, specify an 8-digit Citrix Support case number.
- In the optional **Description** field, describe the issue and indicate when the issue occurred, if applicable.

When you're done, click **Start Upload**.

During the upload, the lower left portion of the page approximates the percentage of the upload that has completed. To cancel an in-progress upload, click **Stop Upload**.

When the upload completes, the URL of its location is displayed and linked. You can follow the link to the Citrix location to view the analysis of the upload, or you can copy the link.

Click **Done** to return to the Scout opening page.

## Trace and reproduce

The **Trace and Reproduce** procedure comprises selecting machines, starting a trace, reproducing issues, completing the diagnostics collection, and then uploading the file to Citrix, or saving it locally.

This procedure is similar to the standard **Collect** procedure. However, it allows you to start a trace on machines and then re-create issues on those machines. All diagnostics collections include AOT trace information. This procedure adds CDF traces to help troubleshooting.

1. Launch Scout. From the machine's **Start** menu, select **Citrix > Citrix Scout**. On the opening page, click **Trace & Reproduce**.
2. Select machines. The **Select machines** page lists all the VDAs and Controllers in the site. You can filter the display by machine name. Select the check box next to each machine you want to collect traces and diagnostics from. Then click **Continue**.

To add other machines manually (such as StoreFront or Citrix Provisioning servers), see [Add machines manually](#).

Scout automatically launches verification tests on each selected machine, making sure it meets the criteria listed in [Verification tests](#). If verification fails for a machine, a message is posted in the **Status** column, and that machine's check box is unselected. You can either:

- Resolve the issue and then select the machine's check box again. This triggers a retry of the verification tests.
- Skip that machine (leave its check box unselected). Diagnostics and traces are not collected from that machine.

When the verification tests complete, click **Continue**.

3. Start the trace. The summary lists all the machines from which traces are collected. Click **Start Tracing**.

On one or more of the selected machines, reproduce the issues you experienced. Trace collection continues while you're doing that. When you're done reproducing the issue, click **Continue** in Scout. That stops the trace.

After you stop the trace, indicate whether you reproduced the issue during the trace.

4. Collect diagnostics from machines. Click **Start Collecting**. During collection:
  - The **Status** column indicates the current collection state for a machine.
  - To stop an in-progress collection on a single machine, click **Cancel** in the **Action** column for that machine.
  - To stop all in-progress collections, click **Stop Collection** in the lower right corner of the page. Diagnostics from machines that have completed collection are kept. To resume the collection, click **Retry** in the **Action** column for each machine.

- When the collection completes for all selected machines, the **Stop Collection** button in the lower right corner changes to **Continue**.
- To collect diagnostics again from a machine, click **Collect Again** in that machine's **Action** column. The newer collection overwrites the earlier.
- If a collection fails, you can click **Retry** in the **Action** column. Only successful collections are uploaded or saved.
- After the collection completes for all selected machines, don't click **Back**. (If you do, the collection is lost.)

When the collection completes, click **Continue**.

5. Save or upload the collection. Choose whether to upload the file to Citrix or save it locally.

If you choose to upload the file now, continue with Step 6.

If you choose to save the file locally:

- A Windows Save dialog box appears. Select the desired location.
- When the local save completes, the pathname of the file is displayed and linked. You can view the file. Remember: You can upload the file later from Citrix; see [CTX136396](#) for Citrix Insight Services.

Click **Done** to return to the Scout opening page. You don't need to complete any further steps in this procedure.

6. Authenticate for uploads and optionally specify proxy. Review Upload authorization for details of this process.
  - If you haven't authenticated through Scout, continue with this step.
  - If you authenticated through Scout, the stored authorization token is used by default. If this what you want to do, choose this option and click **Continue**. You aren't prompted for credentials for this collection. Continue with Step 7.
  - If you previously authenticated, but want to reauthorize and get a new token, click **Change/Reauthorize** and continue with this step.

Choose whether you want to use Citrix credentials or Citrix Cloud credentials to authenticate the upload. Click **Continue**. The credentials page appears only if you're not using a stored token.

On the credentials page:

- If you want to use a proxy server for the file upload, click **Configure proxy**. You can instruct Scout to use the proxy settings configured for your browser's Internet Properties. Or, you can enter the proxy server's IP address and port number. Close the proxy dialog box.

- For a Citrix Cloud account, click **Generate token**. Your default browser launch to a Citrix Cloud page where a token is displayed. Copy the token, and then paste it on the Scout page.
- For a Citrix account, enter your credentials.

When you're done, click **Continue**.

7. Provide information about the upload.

Enter upload details:

- The name field contains the default name for the file for the collected diagnostics. This suffices for most collections, although you can change the name. (If you delete the default name and leave the name field empty, the default name is used.)
- Optionally, specify an 8-digit Citrix Support case number.
- In the optional Description field, describe the issue and indicate when the issue occurred, if applicable.

When you're done, click **Start Upload**.

During the upload, the lower left portion of the page approximates what percentage of the upload has completed. To cancel an in-progress upload, click **Stop Upload**.

When the upload completes, the URL of its location is displayed and linked. You can follow the link to the Citrix location to view the analysis of the upload, or you can copy the link.

Click **Done** to return to the Scout opening page.

## Enable additional log collection

The **Enable additional log collection** function lets you use the trace and reproduce function with more tools, like perfmon, Netsh, DebugView, and Wireshark.

**Note:**

This only applies to local machines.

To set up additional log collection:

1. Launch Citrix Scout.
2. Click the **Settings** gear.
3. Click **Enable additional log collection with more tools**.
4. Click **Save**.

To collect additional logs:

1. On the Scout home page, click **Trace & Reproduce**.

2. On the **Select machines** page, click the gear on the right side of the local machine.
3. On the **Select the tools require for logging:** page, click **Download Tools**.
4. On the **Download Tools** page, select the tools you want to use and click **Download**. The tools are then downloaded, except for Wireshark. Wireshark can only be manually downloaded and installed.  

Note: If you choose to download other tools manually, you must extract the content of the downloaded .zip file to `C:\ProgramData\Citrix\TelemetryService\CDC\Lib\Resources\Tools\<toolname>`. For example, if you download the DebugView.zip file, you would unzip the contents of the file to `C:\ProgramData\Citrix\TelemetryService\CDC\Lib\Resources\Tools\DebugView\`.
5. On the **Select the tools require for logging:** page, click **Refresh Status**. All selected tools appear as **Present** under the Status column.
6. Select the tools for logging, then click **Next**.
7. Follow the [Trace and Reproduce](#) instructions.
8. After completion, check the logs in the zip file. The logs are zipped in the folder `CDCLogs`.

**Note:**

If the Procmon Tool is selected for tracing, Process Monitor logs can grow large quickly. Ensure you select only what tools are needed. You can also monitor the size of the logs under `%temp%\Scout-CDC-Log`.

## Schedule collections

**Note:**

You can currently schedule collections, but not health checks.

The Schedule procedure comprises selecting machines and then setting or canceling the schedule. Scheduled collections are automatically uploaded to Citrix. (You can save scheduled collections locally using the PowerShell interface. See [Citrix Call Home](#).)

1. Launch Scout. From the machine's Start menu, select **Citrix > Citrix Scout**. On the opening page, click **Schedule**.
2. Select machines. All the VDAs and Controllers in the site are listed. You can filter the display by machine name.

When you installed VDAs and Controllers using the graphical interface, if you set a Call Home schedule (see [Citrix Call Home](#)), Scout displays those settings, by default. You can use this version of Scout to start scheduled collections for the first time, or change a previously configured schedule.



Although you enabled/disabled Call Home on a per-machine basis during component installation, a schedule configured in Scout affects all the machines you select.

Select the check box next to each machine you want to collect diagnostics from, and then click **Continue**.

To add other machines manually (such as StoreFront or Citrix Provisioning servers), see Add machines manually.

Scout automatically launches verification tests on each of the selected machines, making sure it meets the criteria in Verification tests. If verification fails for a machine, a message is posted in the **Status** column, and that machine's check box is unselected. You can either:

- Resolve the issue and then select the machine's check box again. This triggers a retry of the verification tests.
- Skip that machine (leave its check box unselected). Diagnostics (or traces) are not collected from that machine.

When the verification tests complete, click **Continue**.

The summary page lists the machines to which schedules are applied. Click **Continue**.

3. Set the schedule. Indicate when you want diagnostics to be collected. Remember: The schedule affects all selected machines.
  - To configure a weekly schedule for the selected machines, click **Weekly**. Choose the day of the week. Enter the time of day (24-hour clock) for the collection to begin.
  - To configure a daily schedule for the selected machines, click **Daily**. Enter the time of day (24-hour clock) for the collection to begin.
  - To cancel an existing schedule for the selected machines (and not replace it with another), click **Off**. This cancels any schedule that was previously configured for those machines.

Click **Continue**.

4. Authenticate for uploads and optionally specify a proxy. Review Upload authorization for details of this process. Remember: You cannot use a stored token to authenticate when working with a Scout schedule.

Choose whether you want to use Citrix credentials or Citrix Cloud credentials to authenticate the upload. Click **Continue**.

On the credentials page:

- If you want to use a proxy server for the file upload, click **Configure proxy**. You can instruct Scout to use the proxy settings configured for your browser's Internet Properties. Or, you can enter the proxy server's IP address and port number. Close the proxy dialog box.

- For a Citrix Cloud account, click **Generate token**. Your default browser launches to a Citrix Cloud page where a token is displayed. Copy the token, and then paste it on the Scout page.
- For a Citrix account, enter your credentials.

When you're done, click **Continue**.

Review the configured schedule. Click **Done** to return to the Scout opening page.

During a collection, each selected machine's Windows application log contains entries about the collection and upload.

## Data masking

The diagnostic information collected using Citrix Scout might contain security-sensitive information. The Citrix Scout data masking feature allows you to mask sensitive data in diagnostics files before uploading them to Citrix.

Scout data masking is configured to mask the IP address, machine names, domain names, user names, hypervisor names, Delivery Group names, catalog names, application names, and SIDs.

### Note:

CDF traces are encrypted and cannot be masked.

Linux VDA logs are compressed to `.tar.gz` format and cannot be masked.

## Collect new diagnostics and perform data masking

To use the Citrix Scout data masking feature, launch Scout from the command line.

1. In Windows, open the command prompt as an administrator.
2. Go to the directory where Scout is installed: `cd C:\Program Files\Citrix\Telemetry Service`.
3. Launch Scout: `ScoutUI.exe datamasking`.
4. Click **Collect** or **Trace & Reproduce** to collect diagnostics.
5. After the collection completes, select **Enable data masking**. This option is enabled by default.
6. Configure the data mask. You can use the default rules or customize the rules.
7. Select whether to upload or save the diagnostics collection.
  - If you select **Upload the diagnostics collection to Citrix**, masked diagnostics files are uploaded to Citrix.
  - If you select **Save the diagnostics collection on your local machine**, both the original and masked diagnostics are saved to the specified location.

### Perform data masking on existing diagnostics

1. In Windows, open the command prompt as an administrator.
2. Go to the directory where Scout is installed: `cd C:\Program Files\Citrix\Telemetry Service`.
3. Launch Scout directly in data masking mode: `ScoutUI.exe datamasking filePath`.
4. Select “Enable data masking” to continue. This option is enabled by default.
5. Configure the data mask. You can run data masking with the default rules or customize the rules.
6. Select whether to upload or save the diagnostics collection.
  - If you select **Upload the diagnostics collection to Citrix**, masked diagnostics files are uploaded to Citrix.
  - If you select **Save the diagnostics collection on your local machine**, both the original and masked diagnostics are saved to the specified location.

### Masked data file and mapping file locations

After you have uploaded or saved the diagnostics collection, click the link to open the original and masked diagnostics, and open the mapping information file.

### Usage data collection

When you use Scout, Citrix uses Google Analytics to collect anonymous usage data to be used for future product features and improvements. Data collection is enabled by default.

To change usage data collection and upload, click the **Settings** gear in the Scout UI. You can then choose whether to send the information by selecting **Yes** or **No** and then clicking **Save**.

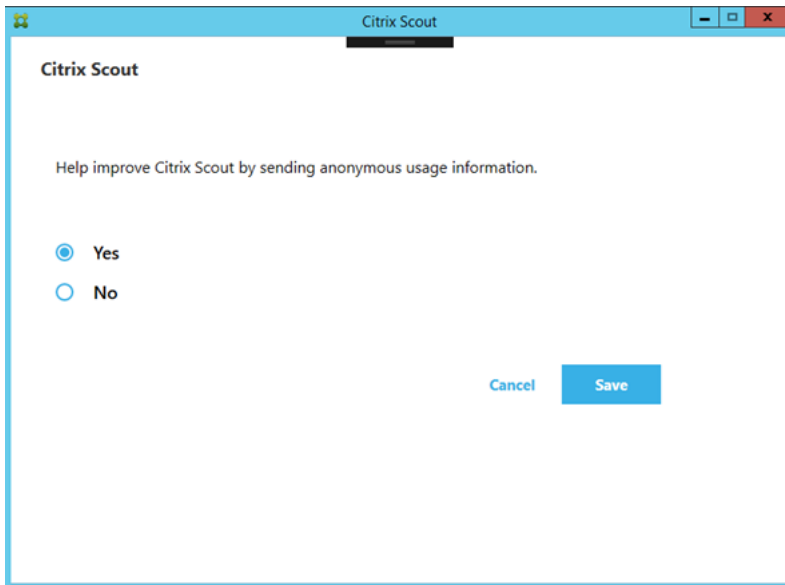

## Collect a Citrix Diagnostic Facility (CDF) trace at system startup

October 19, 2021

The CDFControl utility is an event tracing controller or consumer for capturing Citrix Diagnostic Facility (CDF) trace messages displayed from various Citrix tracing providers. It is intended to troubleshoot complex Citrix-related issues, parse filter support, and collect performance data. To download the CDFControl utility, see [CTX111961](#).

### Use the Local System account

To use the Local System account for the CDF COM server service, complete the following steps:

1. Click **Run** from the **Start** menu.
2. Type `services.msc` in the dialog box and click **OK**.
3. Select the **Citrix Diagnostics Facility COM Server** service and choose **Properties**.
4. Click the **Log On** tab and enable the **Local System** account. Then click **OK**.

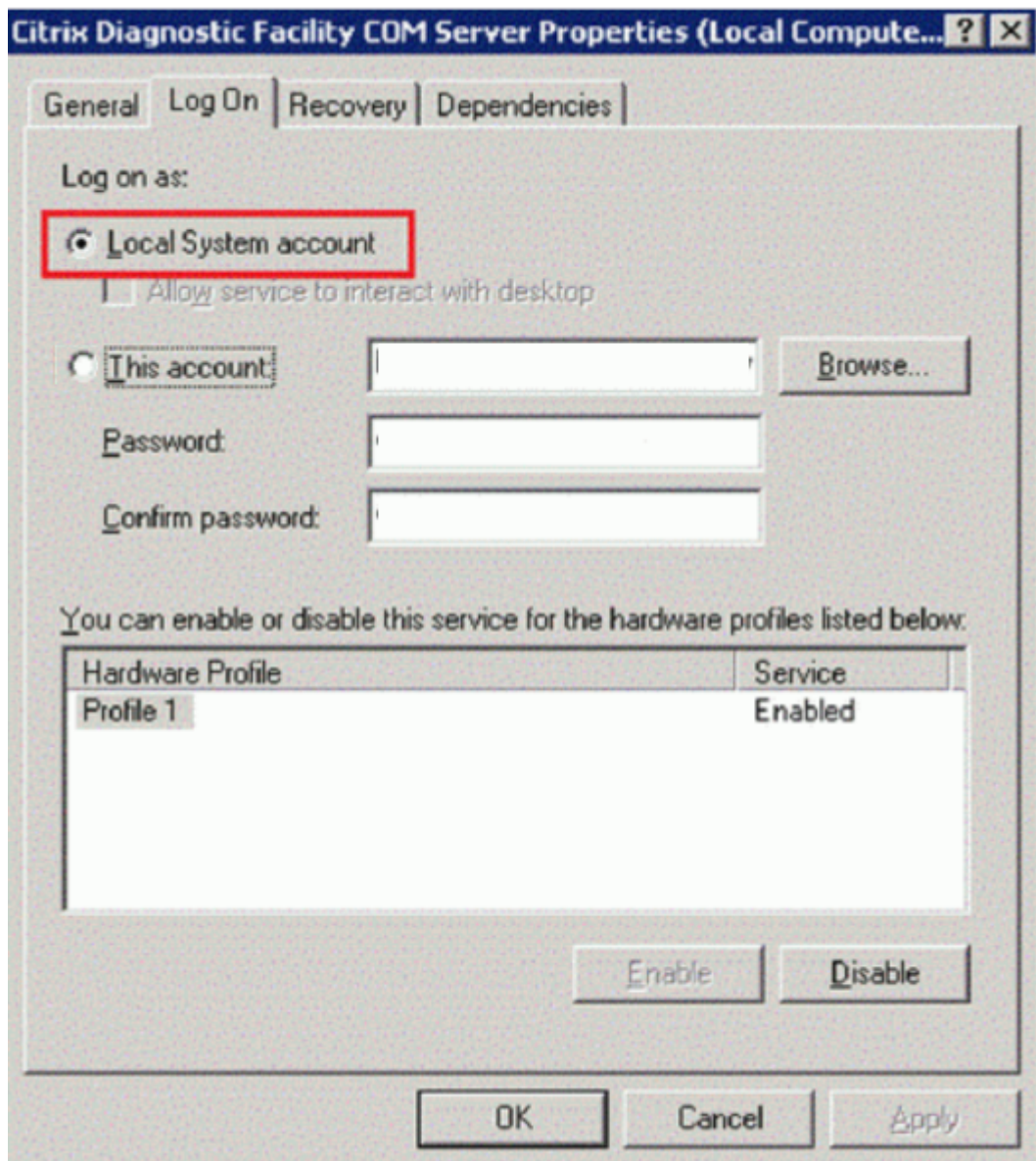

5. Restart the service.

### Collect a trace at system startup

Use the following procedure to collect a CDF trace at system startup. You need administrator privileges.

1. Start **CDFControl** and select **Options** from the **Tools** menu.
2. Specify the trace file path in the **Startup trace file path for capturing startup trace** section. Then click **Save**.

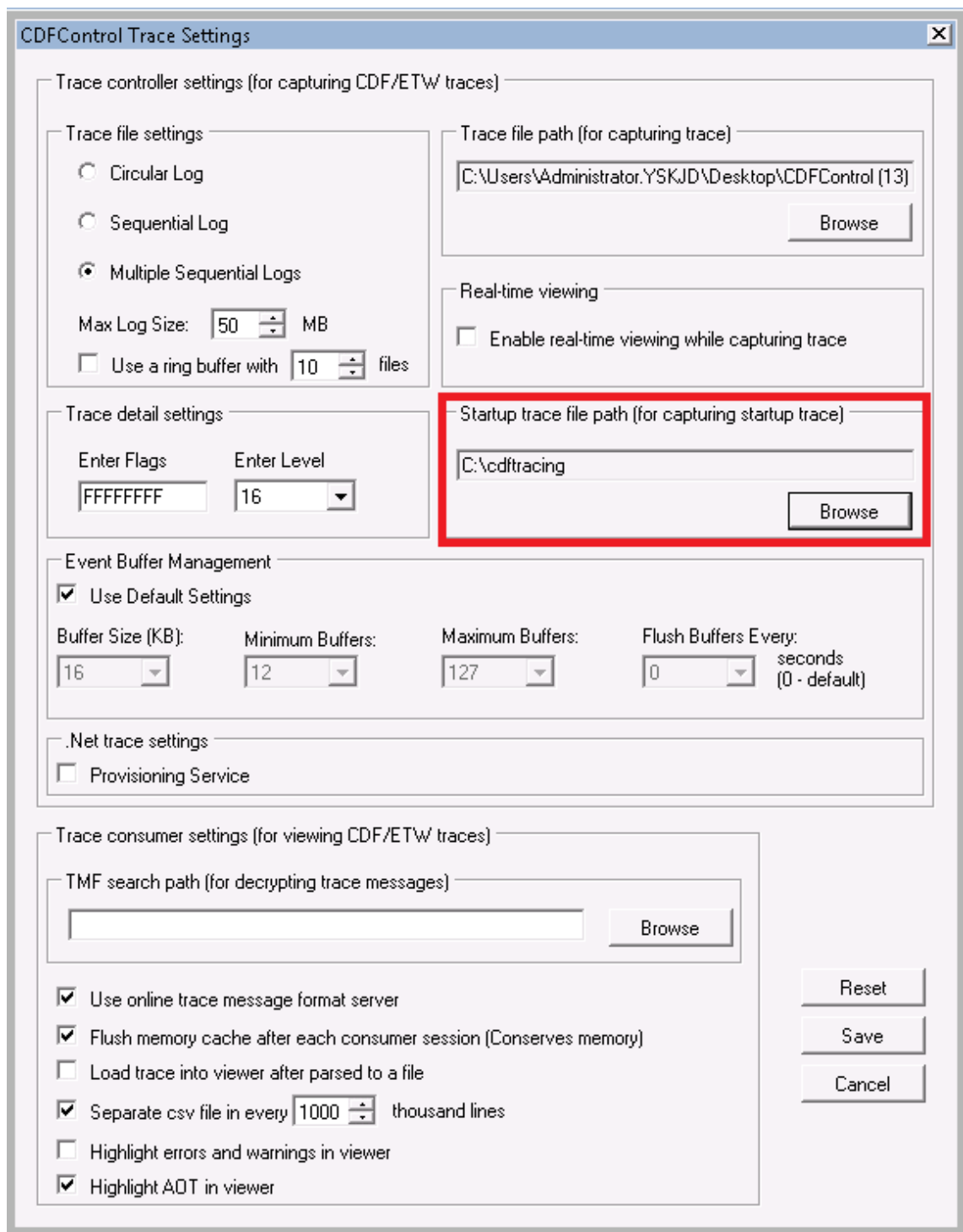

3. Select the **Trace Categories** recommended by Citrix Support. (In the following example, **Citrix Policies** is selected. That selection is only an example. We recommend that you enable the providers for the specific issue you are troubleshooting.)

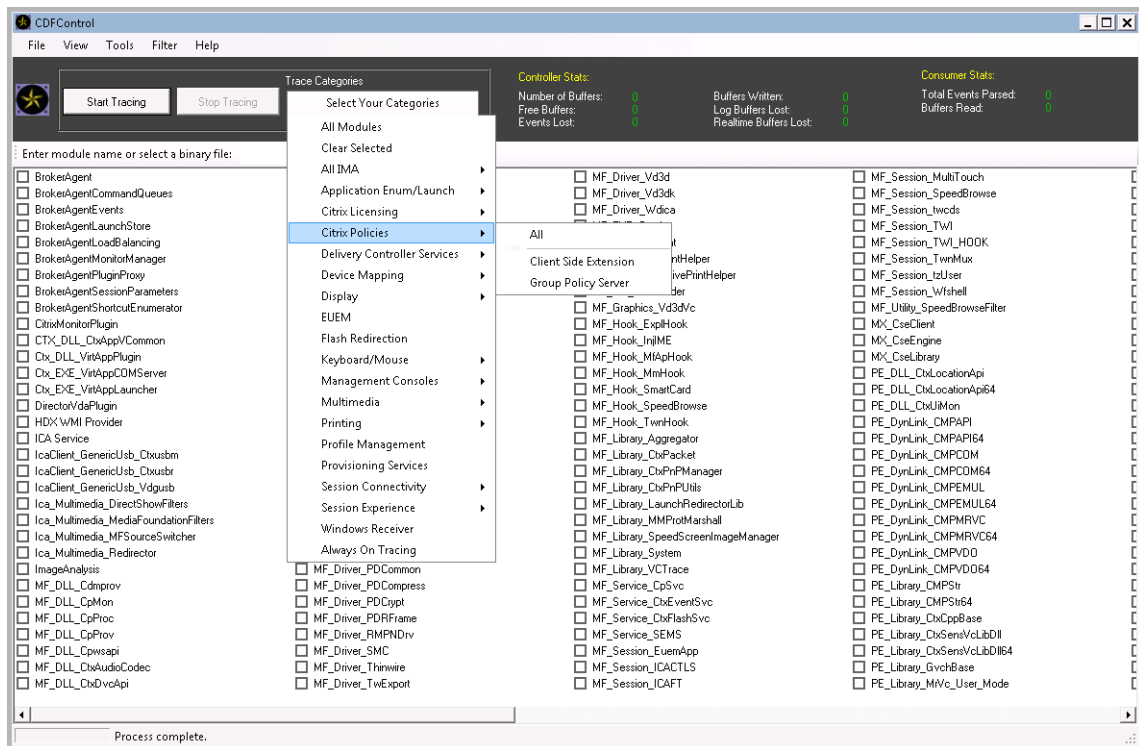

4. Select **Startup Tracing** and select **Enable** from the **Tools** menu.

After selecting **Enable**, the animated bar starts scrolling. This activity does not affect the procedure. Continue to the next step.

5. After the **Startup Tracing** is enabled, close the **CDFControl** utility and restart the system.
6. Start the **CDFControl** utility. After the system restarts and the error appears, disable startup tracing by selecting **Startup Tracing** from the **Tools** menu, and clicking **Disable**.
7. Stop the **Citrix Diagnostics Facility COM** server service.
8. Go to the trace file path specified in step 2 and collect the trace log file (.etl) for analysis.
9. Start the **Citrix Diagnostics Facility COM** server service.

## Delegated administration

March 7, 2023

### Note:

You can manage your Citrix Virtual Apps and Desktops deployment using two management consoles: Web Studio (web-based) and Citrix Studio (Windows-based). This article covers only Web

Studio. For information about Citrix Studio, see the equivalent article in Citrix Virtual Apps and Desktops 7 2212 or earlier.

The delegated administration model offers the flexibility to match how your organization wants to delegate administration activities, using role and object-based control. Delegated administration accommodates deployments of all sizes, and allows you to configure more permission granularity as your deployment grows in complexity. Delegated administration uses three concepts: administrators, roles, and scopes.

- **Administrators:** An administrator represents an individual person or a group of people identified by their Active Directory account. Each administrator is associated with one or more role and scope pairs.
- **Roles:** A role represents a job function, and has defined permissions associated with it. For example, the Delivery Group Administrator role has permissions such as ‘Create Delivery Group’ and ‘Remove Desktop from Delivery Group.’ An administrator can have multiple roles for a site, so a person can be a Delivery Group Administrator and a Machine Catalog Administrator. Roles can be built-in or custom.

The built-in roles are:

| Role                    | Permissions                                                                                                                                                                                                                                                                                                                                                                                                                         |
|-------------------------|-------------------------------------------------------------------------------------------------------------------------------------------------------------------------------------------------------------------------------------------------------------------------------------------------------------------------------------------------------------------------------------------------------------------------------------|
| Full Administrator      | Can perform all tasks and operations. A Full Administrator is always combined with the All scope.                                                                                                                                                                                                                                                                                                                                   |
| Read Only Administrator | Can see all objects in specified scopes in addition to global information, but cannot change anything. For example, a Read Only Administrator with Scope=London can see all global objects (such as Configuration Logging) and any London-scoped objects (for example, London Delivery Groups). However, that administrator cannot see objects in the New York scope (assuming that the London and New York scopes do not overlap). |



---

| Role                          | Permissions                                                                                                                                                                                                                                                                                                   |
|-------------------------------|---------------------------------------------------------------------------------------------------------------------------------------------------------------------------------------------------------------------------------------------------------------------------------------------------------------|
| Help Desk Administrator       | Can view Delivery Groups, and manage the sessions and machines associated with those groups. Can see the Machine Catalog and host information for the Delivery Groups being monitored. Can also perform session management and machine power management operations for the machines in those Delivery Groups. |
| Machine Catalog Administrator | Can create and manage Machine Catalogs and provision the machines into them. Can build Machine Catalogs from the virtualization infrastructure, Provisioning Services, and physical machines. This role can manage base images and install software, but cannot assign applications or desktops to users.     |
| Delivery Group Administrator  | Can deliver applications, desktops, and machines; can also manage the associated sessions. Can also manage application and desktop configurations such as policies and power management settings.                                                                                                             |
| Host Administrator            | Can manage host connections and their associated resource settings. Cannot deliver machines, applications, or desktops to users.                                                                                                                                                                              |

---

In certain product editions, you can create custom roles to match the requirements of your organization, and delegate permissions with more detail. You can use custom roles to allocate permissions at the granularity of an action or task in a console.

- **Scopes:** A scope represents a collection of objects. Scopes are used to group objects in a way that is relevant to your organization (for example, the set of Delivery Groups used by the Sales team). Objects can be in more than one scope; you can think of objects being labeled with one or more scopes. There is one built-in scope: 'All,' which contains all objects. The Full Administrator role is always paired with the All scope.

### Example

Company XYZ decided to manage applications and desktops based on their department (Accounts, Sales, and Warehouse) and their desktop operating system (Windows 7 or Windows 8). The adminis-

trator created five scopes, then labeled each Delivery Group with two scopes: one for the department where they are used and one for the operating system they use.

The following administrators were created:

| Administrator         | Roles                                                       | Scopes                                                     |
|-----------------------|-------------------------------------------------------------|------------------------------------------------------------|
| domain/fred           | Full Administrator                                          | All (the Full Administrator role always has the All scope) |
| domain/rob            | Read Only Administrator                                     | All                                                        |
| domain/heidi          | Read Only Administrator, Help Desk Administrator            | All Sales                                                  |
| domain/warehouseadmin | Help Desk Administrator                                     | Warehouse                                                  |
| domain/peter          | Delivery Group Administrator, Machine Catalog Administrator | Win7                                                       |

- Fred is a Full Administrator and can view, edit, and delete all objects in the system.
- Rob can view all objects in the site but cannot edit or delete them.
- Heidi can view all objects and can perform help desk tasks on Delivery Groups in the Sales scope. This allows her to manage the sessions and machines associated with those groups; she cannot make changes to the Delivery Group, such as adding or removing machines.
- Anyone who is a member of the warehouseadmin Active Directory security group can view and perform help desk tasks on machines in the Warehouse scope.
- Peter is a Windows 7 specialist and can manage all Windows 7 Machine Catalogs and can deliver Windows 7 applications, desktops, and machines, regardless of which department scope they are in. The administrator considered making Peter a Full Administrator for the Win7 scope. However, she decided against this, because a Full Administrator also has full rights over all objects that are not scoped, such as 'Site' and 'Administrator.'

## How to use delegated administration

Generally, the number of administrators and the granularity of their permissions depends on the size and complexity of the deployment.

- In small or proof-of-concept deployments, one or a few administrators do everything. There is no delegation. In this case, create each administrator with the built-in Full Administrator role, which has the All scope.
- In larger deployments with more machines, applications, and desktops, more delegation is needed. Several administrators might have more specific functional responsibilities (roles). For example, two are Full Administrators, and others are Help Desk Administrators. Also, an administrator might manage only certain groups of objects (scopes), such as machine catalogs. In this

case, create new scopes, plus administrators with one of the built-in roles and the appropriate scopes.

- Even larger deployments might require more (or more specific) scopes, plus different administrators with unconventional roles. In this case, edit or create more scopes, create custom roles, and create each administrator with a built-in or custom role, plus existing and new scopes.

For flexibility and ease of configuration, you can create scopes when you create an administrator. You can also specify scopes when creating or editing Machine Catalogs or connections.

## Create and manage administrators

When you create a site as a local administrator, your user account automatically becomes a Full Administrator with full permissions over all objects. After a site is created, local administrators have no special privileges.

The Full Administrator role always has the All scope; you cannot change this.

By default, an administrator is enabled. Disabling an administrator might be necessary if you are creating the administrator now, but that person won't start administration duties until later. For existing enabled administrators, you might want to disable several of them while you are reorganizing your object/scopes, then re-enable them when you are ready to go live with the updated configuration. You cannot disable a Full Administrator if it would result in there being no enabled Full Administrator. The enable/disable check box is available when you create, copy, or edit an administrator.

When you delete a role/scope pair while copying, editing, or deleting an administrator, it deletes only the relationship between the role and the scope for that administrator. It does not delete either the role or the scope. It also does not affect any other administrator who is configured with that role/scope pair.

To create and manage administrators, follow these steps:

1. Sign in to Web Studio, click **Administrators** in the left pane, and then click the **Administrators** tab.
2. Follow the instructions for the task you want to complete:
  - **Create an administrator:** Click **Create Administrator** in the action bar. Type or browse to the user account name, select or create a scope, and then select a role. The new administrator is enabled by default; you can change this.
  - **Copy an administrator:** Select the administrator and then click **Copy Administrator** in the action bar. Type or browse to the user account name. You can select and then edit or delete any of the role/scope pairs, and add new ones. The new administrator is enabled by default; you can change this.

- **Edit an administrator:** Select the administrator and then click **Edit Administrator** in the action bar. You can edit or delete any of the role/scope pairs, and add new ones.
- **Delete an administrator:** Select the administrator and then click **Delete Administrator** in the action bar. You cannot delete a Full Administrator if it would result in there being no enabled Full Administrator.

The upper pane displays the administrators that you created. Select an administrator to view its details in the lower pane. The **Warnings** column indicates whether the role and scope pairs associated with the administrator contain unusable roles or scopes. The following warning message appears if an associated role and scope pair contains unusable roles or scopes:

- Associated role or scope not usable

**Important:**

A warning message appears only when an associated role and scope pair contains unusable roles or scopes or both.

To remove the role and scope pair from the administrator, complete one of the following steps:

- Delete the role and scope pair.
  1. In the action bar, click **Edit Administrator**.
  2. In the **Administrator Name and Details** window, select the role and scope pair and then click **Delete**.
  3. Click **Save** to exit.
- Delete the administrator.
  1. In the action bar, click **Delete Administrator**.
  2. In the confirmation window, Click **Delete**.

## Create and manage roles

When administrators create or edit a role, they can enable only the permissions that they themselves have. This prevents administrators from creating a role with more permissions than they currently have and then assigning it to themselves (or editing a role that they are already assigned).

Role names can contain up to 64 Unicode characters; they cannot contain: backslash, forward slash, semicolon, colon, pound sign, comma, asterisk, question mark, equal sign, left or right arrow, pipe, left or right bracket, left or right parenthesis, quotation marks, or apostrophe. Descriptions can contain up to 256 Unicode characters.

You cannot edit or delete a built-in role. You cannot delete a custom role if any administrator is using it.

**Note:**

Only certain product editions support custom roles. Only editions that support custom roles have related entries in the action bar.

To create and manage roles, follow these steps:

1. Sign in to Web Studio, click **Administrators** in the left pane, and then click the **Roles** tab.
2. Follow the instructions for the task you want to complete:
  - **View role details:** Select the role. The lower pane lists the object types and associated permissions for the role. Click the **Administrators** tab in the lower pane to view a list of administrators who currently have this role.
  - **Create a custom role:** Click **Create Role** in the action pane. Enter a name and description. Select the object types and permissions.
  - **Copy a role:** Select the role, and then click **Copy Role** in the action bar. Change the name, description, object types, and permissions, as needed.
  - **Edit a custom role:** Select the role, and then click **Edit Role** in the action bar. Change the name, description, object types, and permissions, as needed.
  - **Delete a custom role:** Select the role, and then click **Delete Role** in the action bar. When prompted, confirm the deletion.

## Create and manage scopes

When you create a site, the only available scope is the 'All' scope, which cannot be deleted.

You can create scopes using the following procedure. You can also create scopes when you create an administrator; each administrator must be associated with at least one role and scope pair. When you are creating or editing desktops, machine catalogs, applications, or hosts, you can add them to an existing scope. If you do not add them to a scope, they remain part of the 'All' scope.

Site creation cannot be scoped, nor can delegated administration objects (scopes and roles). However, objects you cannot scope are included in the 'All' scope. (Full Administrators always have the All scope.) Machines, power actions, desktops, and sessions are not directly scoped. Administrators can be allocated permissions over these objects through the associated machine catalogs or delivery groups.

Rules for creating and managing scopes:

- Scope names can contain up to 64 Unicode characters. Scope names cannot include: backslash, forward slash, semicolon, colon, pound sign, comma, asterisk, question mark, equal sign, left arrow, right arrow, pipe, left or right bracket, left or right parenthesis, quotation marks, or apostrophe.

- Scope descriptions can contain up to 256 Unicode characters.
- When you copy or edit a scope, keep in mind that removing objects from the scope can make those objects inaccessible to the administrator. If the edited scope is paired with one or more roles, ensure that the scope updates do not make any role/scope pair unusable.

To create and manage scopes, follow these steps:

1. Sign in to Web Studio, click **Administrators** in the left pane, and then click the **Scopes** tab.
2. Follow the instructions for the task you want to complete:
  - **Create a scope:** Click **Create new Scope** in the action bar. Enter a name and description. To include all objects of a particular type (for example, Delivery Groups), select the object type. To include specific objects, expand the type and then select individual objects (for example, Delivery Groups used by the Sales team).
  - **Copy a scope:** Select the scope and then click **Copy Scope** in the actions bar. Enter a name and description. Change the object types and objects, as needed.
  - **Edit a scope:** Select the scope and then click **Edit Scope** in the action bar. Change the name, description, object types, and objects, as needed.
  - **Delete a scope:** Select the scope and then click **Delete Scope** in the action bar. When prompted, confirm the deletion.

## Create reports

You can create two types of delegated administration reports:

- An HTML report that lists the role/scope pairs associated with an administrator, plus the individual permissions for each type of object (for example, delivery groups and machine catalogs). You generate this report from Web Studio.

To create this report, follow these steps:

1. Sign in to Web Studio, click **Administrators** in the left pane
2. Select an administrator and then click **Create Report** in the action bar.

You can also request this report when creating, copying, or editing an administrator.

- An HTML or CSV report that maps all built-in and custom roles to permissions. You generate this report by running a PowerShell script named OutputPermissionMapping.ps1.

To run this script, you must be a Full Administrator, a Read Only Administrator, or a custom administrator with permission to read roles. The script is located in: Program Files\Citrix\DelegatedAdmin\SnapIn\Citrix.DelegatedAdmin.Admin.V1\Scripts.

Syntax:

```
OutputPermissionMapping.ps1 [-Help] [-Csv] [-Path string] [-AdminAddress string] [-Show] [CommonParameters]
```

| Parameter            | Description                                                                                                                                                                         |
|----------------------|-------------------------------------------------------------------------------------------------------------------------------------------------------------------------------------|
| -Help                | Displays script help.                                                                                                                                                               |
| -Csv                 | Specifies CSV output. Default = HTML                                                                                                                                                |
| -Path string         | Where to write the output. Default = stdout                                                                                                                                         |
| -AdminAddress string | IP address or host name of the Delivery Controller to connect to. Default = localhost                                                                                               |
| -Show                | (Valid only when the -Path parameter is also specified) When you write the output to a file, -Show causes the output to be opened in an appropriate program, such as a web browser. |
| CommonParameters     | Verbose, Debug, ErrorAction, ErrorVariable, WarningAction, WarningVariable, OutBuffer, and OutVariable. For details, see the Microsoft documentation.                               |

The following example writes an HTML table to a file named Roles.html and opens the table in a web browser.

```
1 & "$env:ProgramFiles\Citrix\DelegatedAdmin\SnapIn\
2 Citrix.DelegatedAdmin.Admin.V1\Scripts\OutputPermissionMapping.ps1"
3 -Path Roles.html - Show
4 <!--NeedCopy-->
```

The following example writes a CSV table to a file named Roles.csv. The table is not displayed.

```
1 & "$env:ProgramFiles\Citrix\DelegatedAdmin\SnapIn\
2 Citrix.DelegatedAdmin.Admin.V1\Scripts\OutputPermissionMapping.ps1"
3 - CSV -Path Roles.csv
4 <!--NeedCopy-->
```

From a Windows command prompt, the preceding example command is:

```
1 powershell -command "& '%ProgramFiles%\Citrix\DelegatedAdmin\SnapIn\
2 Citrix.DelegatedAdmin.Admin.V1\Scripts\OutputPermissionMapping.ps1'
3 -CSV -Path Roles.csv"
4 <!--NeedCopy-->
```

## Delivery Controllers

March 24, 2023

### Note:

You can manage your Citrix Virtual Apps and Desktops deployment using two management consoles: Web Studio (web-based) and Citrix Studio (Windows-based). This article covers only Web Studio. For information about Citrix Studio, see the equivalent article in Citrix Virtual Apps and Desktops 7 2212 or earlier.

The Delivery Controller is the server-side component that is responsible for managing user access, plus brokering and optimizing connections. Controllers also provide the Machine Creation Services that create desktop and server images.

A site must have at least one Controller. After you install the initial Controller, you can add more Controllers when you create a site, or later. There are two primary benefits from having more than one Controller in a site.

- **Redundancy:** As best practice, in a production site, always have at least two Controllers on different physical servers. If one Controller fails, the others can manage connections and administer the site.
- **Scalability:** As site activity grows, so does CPU utilization on the Controller and database activity. Additional Controllers enable you to handle more users and more applications and desktop requests, and can improve overall responsiveness.

Each Controller communicates directly with the site database. In a site with more than one zone, the Controllers in every zone communicate with the site database in the primary zone.

### Important:

Do not change the computer name or the domain membership of a Controller after the site is configured.

## How VDAs register with Controllers

Before a VDA can be used, it must register (establish communication) with a Delivery Controller in the site. For information about VDA registration, see [VDA registration with Controllers](#).

## Add, remove, or move Controllers

To add, remove, or move a Controller, you must have the server role and database role permissions listed in the [Databases](#) article.



Installing a Controller on a node in an SQL clustering or SQL mirroring installation is not supported.

When you add a Delivery Controller to a site, be sure to add logon credentials for that machine to any replica SQL Servers that you use for high availability.

If your deployment uses database mirroring:

- Before adding, removing, or moving a Controller, ensure that the principal and mirrored databases are both running. In addition, if you are using scripts with SQL Server Management Studio, enable SQLCMD mode before running the scripts.
- To verify mirroring after adding, removing, or moving a Controller, run the PowerShell `Get-configdbconnection` cmdlet. That cmdlet ensures that the Failover Partner has been set in the connection string to the mirror.

After you add, remove, or move a Controller:

- If auto-update is enabled, the VDAs receive an updated list of Controllers within 90 minutes.
- If auto-update is not enabled, ensure that the Controller policy setting or ListOfDDCs registry key are updated for all VDAs. After moving a Controller to another site, update the policy setting or registry key on both sites.

## Add a Controller

You can add Controllers when you create a site and later. You cannot add Controllers installed with an earlier version of this software to a site that was created with this version.

1. Run the installer on a server containing a supported operating system. Install the Delivery Controller component and any other core components you want. Complete the installation wizard.
2. If you have not yet created a site, run [Citrix Site Manager](#) on this Controller to create a site. The IP address of this Controller is automatically added to the new site.

If you plan to generate scripts that initialize the databases, add the Controllers before you generate the scripts.

3. If you have already created a site, follow these steps:
  - a) Run [Citrix Site Manager](#) on this Controller, click **Join an existing site**, and type the address of a Controller in the site that you want to join.
  - b) Run [Studio configuration tool](#) to add the Controller to the Web Studio.

## Remove a Controller

Removing a Controller from a site does not uninstall the Citrix software or any other component. That action removes the Controller from the database so that it can no longer be used to broker connections and perform other tasks. If you remove a Controller, you can later add it back to the same site

or to another site. A site requires at least one Controller, so you cannot remove the last one listed in Web Studio.

When you remove a Controller from a site, the Controller logon to the database server is not removed. This avoids potentially removing a logon that is used by other products' services on the same machine. The logon must be removed manually if it is no longer required. The `securityadmin` server role permission is needed to remove the logon.

After you remove a Controller:

- VDAs using auto-update reregister with other available Controllers. This reregistration occurs only if the auto-update mechanism is enabled and the VDAs can reach other controllers (in the same secondary zone as the removed Controller, or in the primary zone for on-premises deployments).
- Update Controller information in Citrix StoreFront. For more information, see [Manage Controllers](#).
- In Citrix StoreFront, update Secure Ticket Authority (STA) URLs for remote access through Citrix Gateway. For more information, see [Manage Secure Ticket Authorities](#).
- In Citrix Gateway, update any virtual server STA URLs. For more information, see [Citrix Gateway](#).

#### **Important:**

Do not remove the Controller from Active Directory until after you remove it from the site.

1. Make sure that the Controller is powered on so that Web Studio loads in less than one hour. Once Web Studio loads the Controller you want to remove, make sure that all the services on the Controller are running and the Controller is powered off.
2. Sign in to Web Studio, select **Settings** in the left pane.
3. Locate the **Delivery Controller** tile and click **Edit**.
4. On the **Manage Delivery Controller** page, select the Controller you want to remove.
5. Select **Remove Controller**. If you do not have the correct database roles and permissions, you are offered the option of generating a script that allows your database administrator to remove the Controller for you.

Web Studio performs a pre-check before removing a Controller. A controller is safe to remove if it is powered off and not in the following service status:

- Unknown
- Pending failure
- Older version
- Newer version
- Version change in progress
- Missing mandatory features

If the Controller is not powered off and is in any of the mentioned service status, Web Studio prompts you to power off the Controller.

6. You must remove the Controller's machine account from the database server. Before removing, check that another service is not using the account.

After using Web Studio to remove a Controller, traffic to that Controller might linger for a short amount of time to ensure proper completion of current tasks. If you want to force the removal of a Controller in a short time, Citrix recommends you shut down the server where it was installed, or remove that server from Active Directory. Then, restart the other Controllers on the site to ensure no further communication with the removed Controller.

### **Move a Controller to another zone**

If your site contains more than one zone, you can move a Controller to a different zone. See the [Zones](#) for information about how this moving can affect VDA registration and other operations.

1. Select **Zone** in the left pane.
2. Select a zone in the middle pane, and then select a Controller.
3. Select **Move Items** in the action bar.
4. On the **Move Items** page that appears, select the zone where you want to move the Controller.
5. Click **Save**.

### **Move a VDA to another site**

If a VDA was provisioned using Citrix Provisioning or is an existing image, you can move a VDA to another site (from site 1 to site 2) when upgrading, or when moving a VDA image that was created in a test site to a production site. VDAs provisioned using Machine Creation Services (MCS) cannot be moved from one site to another. MCS does not support changing the ListOfDDCs a VDA checks to register with a Controller. VDAs provisioned using MCS always check the ListOfDDCs associated with the site in which they were created.

There are two ways to move a VDA to another site: using the installer or Citrix policies.

**Installer** Run the installer and add a Controller, specifying the FQDN (DNS entry) of a Controller in site 2.

Specify Controllers in the installer only when the Controllers policy setting is not used.

**Group Policy Editor** The following example moves multiple VDAs between sites.

1. Create a policy in site 1 that contains the following settings, then filter the policy to the Delivery Group level to initiate a staged VDA migration between the sites.
  - Controllers: Containing FQDNs (DNS entries) of one or more Controllers in site 2.
  - Enable auto update of Controllers: set to disabled.
2. Each VDA in the Delivery Group is alerted within 90 minutes of the new policy. The VDA ignores the list of Controllers it receives (because auto-update is disabled); it selects one of the Controllers specified in the policy, which lists the Controllers in site 2.
3. When the VDA successfully registers with a Controller in site 2, it receives the site 2 ListOfDDCs and policy information, which has auto-update enabled by default. The Controller with which the VDA was registered in site 1 is not on the list sent by the Controller in site 2. So, the VDA re-registers, choosing among the Controllers in the site 2 list. From then on, the VDA is automatically updated with information from site 2.

For information about how to use the Group Policy Editor, see the [Citrix policies](#) documentation.

## IPv4/IPv6 support

March 20, 2024

This release supports pure IPv4, pure IPv6, and dual-stack deployments that use overlapping IPv4 and IPv6 networks.

The following components support only IPv4. All others support IPv4 and IPv6.

- XenServer
- Virtual Delivery Agents (VDAs) not controlled by the **Only use IPv6 Controller registration** policy setting

IPv6 communications are controlled with two VDA connection-related Citrix policy settings.

- **Primary setting that enforces the use of IPv6:** Only use IPv6 Controller registration.

This policy setting controls which form of address the VDA uses to register with the Delivery Controller.

When enabled, the VDA registers and communicates with the Controller using a single IPv6 address chosen in the following precedence: global IP address, Unique Local Address (ULA), link-local address (only if no other IPv6 addresses are available).

When disabled, the VDA registers and communicates with the Controller using the machine's IPv4 address. This is the default value.

If a team frequently uses an IPv6 network, publish the desktops and applications for those users based on an image or Organizational Unit (OU) that has the **Only use IPv6 Controller registration** policy setting enabled.

If a team frequently uses an IPv4 network, publish the desktops and applications for those users based on an image or OU that has the **Only use IPv6 Controller registration** policy setting disabled.

- **Dependent setting that defines an IPv6 netmask:** Controller registration IPv6 netmask.

A machine can have multiple IPv6 addresses. This policy setting allows administrators to restrict the VDA to only a preferred subnet, rather than a global IP, if one is registered. This setting specifies the network where the VDA registers. The VDA registers only on the first address that matches the specified netmask.

This setting is valid only when the **Only use IPv6 Controller registration policy** setting is enabled. Default = Empty string

## Deployment considerations

If your environment contains both IPv4 and IPv6 networks, create separate delivery group configurations for IPv4-only clients and for the clients who can access the IPv6 network. Consider using naming, manual Active Directory group assignment, or SmartAccess filters to differentiate users.

Session reconnection might fail if the connection starts on an IPv6 network, and then you try to connect again from a client that has only IPv4 access.

NOTE - These considerations do not apply if you have [DNS resolution enabled](#)

## Licensing for Citrix Virtual Apps and Desktops using Web Studio

June 29, 2023

### Note:

You can manage your Citrix Virtual Apps and Desktops deployment using two management consoles: Web Studio (web-based) and Citrix Studio (Windows-based). This article covers only Web Studio. For information about Citrix Studio, see the equivalent article in Citrix Virtual Apps and Desktops 7 2212 or earlier.

From Web Studio, you can manage and track licensing, if the license server is in the same domain as Web Studio or in a trusted domain. For information about licensing tasks, see the [licensing documentation](#) and [Multi-type licensing](#).

The following table lists the supported editions and license models:

| Products                | Editions                    | License models             |
|-------------------------|-----------------------------|----------------------------|
| Citrix Virtual Apps     | Premium, Advanced, Standard | Concurrent                 |
| Citrix Virtual Desktops | Premium, Advanced, Standard | User/Device and Concurrent |

For more information, see [Concurrent license](#) and [User/device license](#).

### Supported Current Release (CRs) and Long Term Service Release (LTSRs) version

The following table lists the **Minimum compatible LS version** for Citrix Virtual Apps and Desktops, XenApp, and XenDesktop. For more information about Citrix products lifecycle dates, see [Product Matrix](#).

#### Important:

The information in the following table is provided for product compatibility only. Citrix strongly recommends that you always use the [latest available version of Citrix License Server](#) to benefit from any functional or security improvements it may contain.

#### Note:

The License Server VPX is deprecated and won't receive any further maintenance or security fixes. Customers using 11.16.6 or previous versions of License Server VPX are advised to migrate to the [latest version of License Server for Windows](#) as soon as possible.

| Current release | Minimum compatible LS version |
|-----------------|-------------------------------|
| 2305            | 11.17.2.0 Build 35000         |
| 2303            | 11.17.2.0 Build 35000         |
| 2212            | 11.17.2.0 Build 35000         |
| 2209            | 11.17.2.0 Build 35000         |
| 2206            | 11.17.2.0 Build 35000         |
| 2203            | 11.17.2.0 Build 35000         |
| 2112            | 11.17.2.0 Build 35000         |
| 2109            | 11.17.2.0 Build 35000         |
| 2106            | 11.17.2.0 Build 35000         |

---

| Current release | Minimum compatible LS version |
|-----------------|-------------------------------|
|-----------------|-------------------------------|

---

|      |                       |
|------|-----------------------|
| 2103 | 11.16.3.0 Build 28000 |
|------|-----------------------|

---

---

| Long Term Service Release | Minimum compatible LS version |
|---------------------------|-------------------------------|
|---------------------------|-------------------------------|

---

|           |                       |
|-----------|-----------------------|
| 2203 LTSR | 11.17.2.0 Build 35000 |
|-----------|-----------------------|

|           |                       |
|-----------|-----------------------|
| 1912 LTSR | 11.16.3.0 Build 28000 |
|-----------|-----------------------|

|           |                       |
|-----------|-----------------------|
| 7.15 LTSR | 11.15.0.0 Build 24100 |
|-----------|-----------------------|

|          |                       |
|----------|-----------------------|
| 7.6 LTSR | 11.14.0.1 Build 21103 |
|----------|-----------------------|

---

For information on legacy products and product versions, refer to the [Legacy Product Matrix](#).

You must be a full license administrator to complete the the following tasks. To view license information in Web Studio, an administrator must have at least the Read Licensing delegated administration permission. The built-in Full Administrator and Read-Only Administrator roles have that permission.

### Download and install a license from Citrix using Web Studio

1. Sign in to Web Studio and select **Licensing** in the left pane.
2. Select **Allocate Licenses** in the action bar.
3. Enter the License Access Code, you received in an email from Citrix after licenses are purchased or renewed.
4. Select a product and choose **Allocate Licenses**. Licenses available for that product are allocated and downloaded. After you allocate and download all the licenses for a specific License Access Code, you cannot reuse that License Access Code. To do other transactions with the same code, log on to My Account.

### Add licenses that are stored on your local computer or on the network

1. Sign in to Web Studio and select **Licensing** in the left pane.
2. Select **Add Licenses** in the action bar.
3. Browse to a license file and add it to the license server.

### Change the license server

1. Sign in to Web Studio and select **Licensing** in the left pane.

2. Select **Change License Server** in the action bar.
3. Type the address of the license server in the form *name:port*, where the name is a DNS, NetBIOS, or IP address. If you do not specify a port number, the default port (27000) is used.

### Select the type of license to use

- When configuring the Site, after you specify the license server, you're prompted to select the type of license to use. If there are no licenses on the server, the option to use the product for a 30-day trial period without a license is automatically selected.
- If there are licenses on the server, their details are displayed and you can select one of them. Or, you can add a license file to the server and then select that one.

### Change the product edition and licensing model

1. Sign in to Web Studio and select **Licensing** in the left pane.
2. Select **Edit Product Edition** in the action bar.
3. Update the appropriate options.

To access the License Administration Console, in the action bar, select **License Administration Console**. The console either appears immediately, or if the dashboard is configured as password-protected, you're prompted for License Administration Console credentials. For details about how to use the console, see the licensing documentation.

#### Note:

When you switch licenses in the Web Studio, the change takes up to 5 minutes to appear in the Citrix Director. For example, if you switch between Advanced and Premium or vice versa.

### Add a licensing administrator

1. Sign in to Web Studio and select **Licensing** in the left pane.
2. Select the **Licensing Administrators** tab.
3. Select **Add licensing administrator** in the action bar.
4. Browse to the user you want to add as an administrator and choose permissions.

### Change a licensing administrator's permissions or delete a licensing administrator

1. Sign in to Web Studio and select **Licensing** in the left pane.
2. Select the **Licensing Administrators** tab and then select the administrator.
3. Select either **Edit licensing administrator** or **Delete licensing administrator** in the action bar.



## Add a licensing administrator group

1. Sign in to Web Studio and select **Licensing** in the left pane.
2. Select the **Licensing Administrators** tab.
3. Select **Add licensing administrator group** in the action bar.
4. Browse to the group you want to act as licensing administrators and choose permissions. Adding an Active Directory Group gives licensing administrator permissions to the users within that group.

## Change a licensing administrator group's permissions or delete a licensing administrator group

1. Sign in to Web Studio and select **Licensing** in the left pane.
2. Select the **Licensing Administrators** tab and then select the administrator group.
3. Select either **Edit licensing administrator group** or **Delete licensing administrator group** in the action bar.

## View license information

Sign in to Web Studio and select **Licensing** in the left pane. A summary of license usage and settings for the Site is displayed with a list of all the licenses currently installed on the specified license server.

Ensure that the licensing settings for the site, which include the product type, license edition, and licensing model, match the licenses your configured License Server uses. If not, you might have to download or allocate your exiting licenses to match the site's license settings.

## View license expiration alerts

Web Studio queries for license file expiration dates from the Citrix License Server. Web Studio alerts administrators on the Overview tab if license files are approaching expiration or already expired.

## Related links

- See [Citrix on-premises subscription for annual and term-based retail licenses](#).
- See [Transition and Trade-Up \(TTU\) with Hybrid Rights](#).

## Multi-type licensing

July 7, 2023

Multi-type licensing supports consumption of different license types for delivery groups on a single Citrix Virtual Apps and Desktops site. **Type** is a single combination of Product ID (XDT or MPS) and Model (UserDevice or Concurrent). The delivery groups must use the same Product Edition (PLT/Premium or ENT/Advanced) as configured at the site level. Be aware of the [special considerations](#) at the end of this article when looking to configure multi-type licensing for your Citrix Virtual Apps and Desktops deployments.

If multi-type licensing is not configured, different license types can be used only when configured for separate sites. The delivery groups use the site license. For important notification limitations when multi-type licensing is configured, see [Special considerations](#).

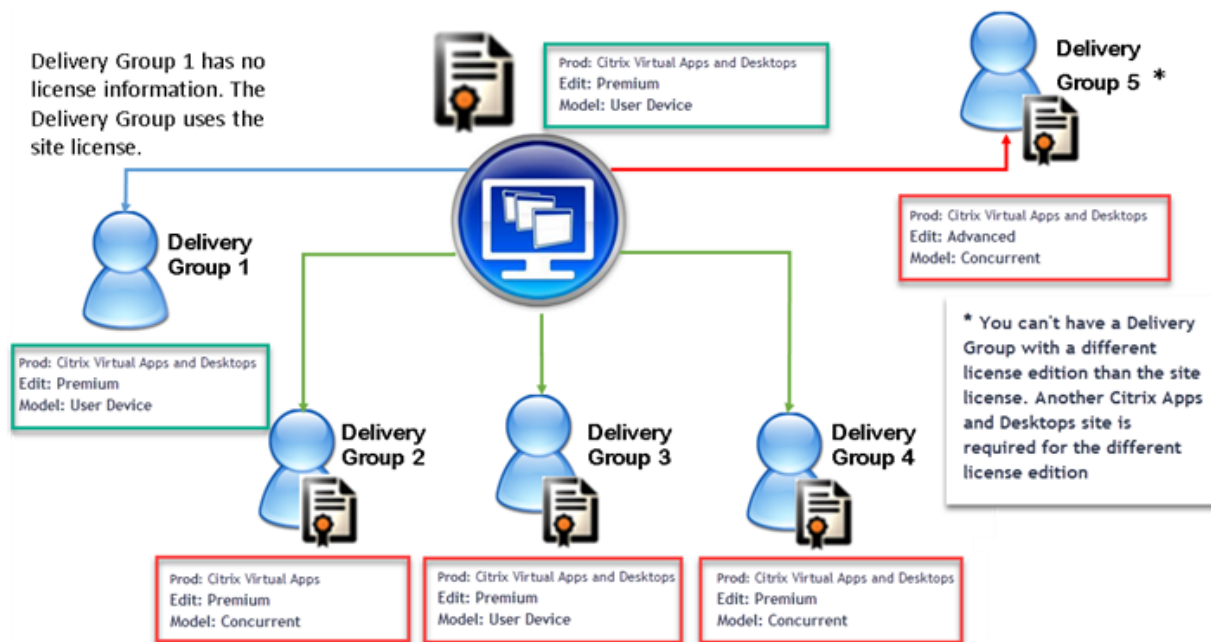

To determine the delivery groups that consume the different types of licenses, use these Broker PowerShell cmdlets:

- New-BrokerDesktopGroup
- Set-BrokerDesktopGroup
- Get-BrokerDesktopGroup

To install licenses, use:

- Citrix Studio
- Citrix Licensing Manager

- citrix.com

Customer Success Services dates are specific to each license file and to each product and model. Delivery groups set differently might have different Customer Success Services dates than each other.

## Special considerations

Multi-type licensing has different functionality than regular Citrix Virtual Apps and Desktops licensing.

There are no alerts and notifications from Director or Studio for delivery groups configured to use a type that differs from the site configuration:

- No information when nearing license limits or the trigger or expiry of the supplemental grace period.
- No notification when a specific group has a problem.

Delivery groups configured for multi-type licenses consume ONLY that license type and don't fall back to the site configuration when fully consumed.

Though Citrix Virtual Apps Standard and Citrix Virtual Desktops Standard license edition names indicate that they are both Standard, they are not the same edition. Multi-type licensing is not available with Citrix Virtual Apps Standard and Citrix Virtual Desktop Standard licenses.

## License compatibility matrix

This table details old product names, new product names, and the associated feature names. The four compatibility columns specify which product and license model combinations are compatible for multi-type licensing. CCU and CCS stand for concurrent licenses and UD is user/device licenses.

| Old Name                                     | New Name                                                    | Feature     | Multi-type licensing compatibility |     |     |     |
|----------------------------------------------|-------------------------------------------------------------|-------------|------------------------------------|-----|-----|-----|
|                                              |                                                             |             | STD                                | ADV | ENT | PLT |
| Citrix XenApp Standard                       | Citrix XenApp Standard                                      | MPS_STD_CCU | X                                  |     |     |     |
| Citrix XenApp Advanced                       | Citrix Virtual Apps Standard                                | MPS_ADV_CCU |                                    | X   |     |     |
| Citrix XenApp Enterprise                     | Citrix Virtual Apps Advanced                                | MPS_ENT_CCU |                                    |     | X   |     |
| Citrix XenApp Platinum                       | Citrix Virtual Apps Premium                                 | MPS_PLT_CCU |                                    |     |     | X   |
| Citrix XenDesktop VDI Edition (XDT-U)        | Citrix Virtual Desktops Standard - Per User/Device          | XDT_STD_UD  | X                                  |     |     |     |
| Citrix XenDesktop VDI Edition (XDT-C)        | Citrix Virtual Desktops Standard - Concurrent               | XDT_STD_CCS | X                                  |     |     |     |
| Citrix XenDesktop Enterprise Edition (XDT-C) | Citrix Virtual Apps and Desktops Advanced - Concurrent      | XDT_ENT_CCS |                                    |     | X   |     |
| Citrix XenDesktop Enterprise Edition (XDT-U) | Citrix Virtual Apps and Desktops Advanced - Per User/Device | XDT_ENT_UD  |                                    |     | X   |     |
| Citrix XenDesktop Platinum Edition (XDT-C)   | Citrix Virtual Apps and Desktops Premium - Concurrent       | XDT_PLT_CCS |                                    |     |     | X   |
| Citrix XenDesktop Platinum Edition (XDT-U)   | Citrix Virtual Apps and Desktops Premium - Per User/Device  | XDT_PLT_UD  |                                    |     |     | X   |

## Broker PowerShell SDK

The **DesktopGroup** object has these two properties you can manipulate using the associated New-BrokerDesktopGroup and Set-BrokerDesktopGroup cmdlets.

---

| Name         | Value                                                                                                                                                                                            | Restriction                                                            |
|--------------|--------------------------------------------------------------------------------------------------------------------------------------------------------------------------------------------------|------------------------------------------------------------------------|
| LicenseModel | A parameter (Concurrent or UserDevice) specifying the licensing model for the group. If none is specified, the site-wide license model is used.                                                  | If the feature toggle is disabled, attempting to set a property fails. |
| ProductCode  | A text string of XDT (for Citrix Virtual Desktops) or MPS (for Citrix Virtual Apps) specifying the licensing Product ID for the group. If none is specified, the site-wide product code is used. | If the feature toggle is disabled, attempting to set a property fails. |

---

For more information about the LicenseModel and ProductCode, see [about\\_Broker\\_Licensing](#).

### New-BrokerDesktopGroup

Creates a desktop group for managing the brokering of groups of desktops. For more information on this cmdlet, see <https://citrix.github.io/delivery-controller-sdk/Broker/New-BrokerDesktopGroup/>.

### Set-BrokerDesktopGroup

Disables or enables an existing broker desktop group or alters its settings. For more information on this cmdlet, see <https://citrix.github.io/delivery-controller-sdk/Broker/Set-BrokerDesktopGroup/>

### Get-BrokerDesktopGroup

Retrieves desktop groups matching the specified criteria. The output of the Get-BrokerDesktopGroup cmdlet includes the **ProductCode** and **LicenseModel** properties of the group. If the properties have not been set using New- BrokerDesktopGroup or Set-BrokerDesktopGroup, null values are returned. If null, the site-wide license model and product code are used. For more information on this cmdlet, see <https://citrix.github.io/delivery-controller-sdk/Broker/Get-BrokerDesktopGroup/>.

## Configure different license products and models per delivery group

### Note:

You can't configure two or more different types of products, editions, or license models configured on a single delivery group. In case you have different types of products, editions, or license models, configure them in separate delivery groups.

1. Open PowerShell with Administrative rights and add the Citrix snap-in.



2. Run the command **Get-BrokerDesktopGroup -Name "DeliveryGroupName"** to view the current license configuration. Find the parameters **LicenseModel** and **ProductCode**. If you haven't configured these parameters before, they might be blank.

### Note:

If a delivery group does not have license information set, it defaults to **Site level Site license**.

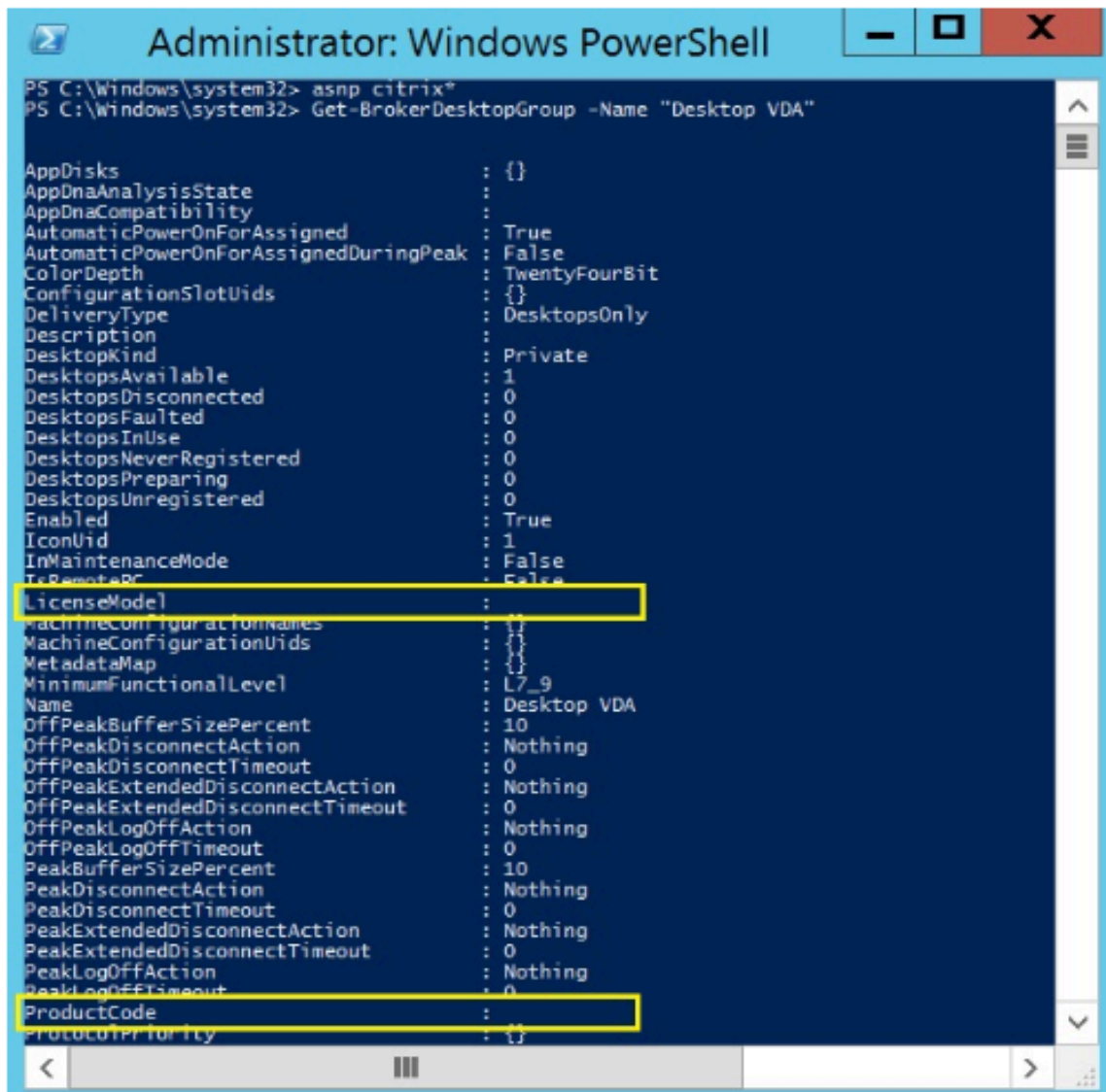

```
Administrator: Windows PowerShell
PS C:\Windows\system32> asnp citrix*
PS C:\Windows\system32> Get-BrokerDesktopGroup -Name "Desktop VDA"

AppDisks : {}
AppDnaAnalysisState :
AppDnaCompatibility :
AutomaticPowerOnForAssigned : True
AutomaticPowerOnForAssignedDuringPeak : False
ColorDepth : TwentyFourBit
ConfigurationSlotUids : {}
DeliveryType : DesktopsOnly
Description :
DesktopKind : Private
DesktopsAvailable : 1
DesktopsDisconnected : 0
DesktopsFaulted : 0
DesktopsInUse : 0
DesktopsNeverRegistered : 0
DesktopsPreparing : 0
DesktopsUnregistered : 0
Enabled : True
IconUid : 1
InMaintenanceMode : False
IsRemotePC : False
LicenseModel :
MachineConfigurationNames : {}
MachineConfigurationUids : {}
MetadataMap : {}
MinimumFunctionalLevel : L7_9
Name : Desktop VDA
OffPeakBufferSizePercent : 10
OffPeakDisconnectAction : Nothing
OffPeakDisconnectTimeout : 0
OffPeakExtendedDisconnectAction : Nothing
OffPeakExtendedDisconnectTimeout : 0
OffPeakLogOffAction : Nothing
OffPeakLogOffTimeout : 0
PeakBufferSizePercent : 10
PeakDisconnectAction : Nothing
PeakDisconnectTimeout : 0
PeakExtendedDisconnectAction : Nothing
PeakExtendedDisconnectTimeout : 0
PeakLogOffAction : Nothing
PeakLogOffTimeout : 0
ProductCode :
ProductPriority : {}
```

3. Change the license model by running the command: **Set-BrokerDesktopGroup -Name "DeliveryGroupName"-LicenseModel LicenseModel.**

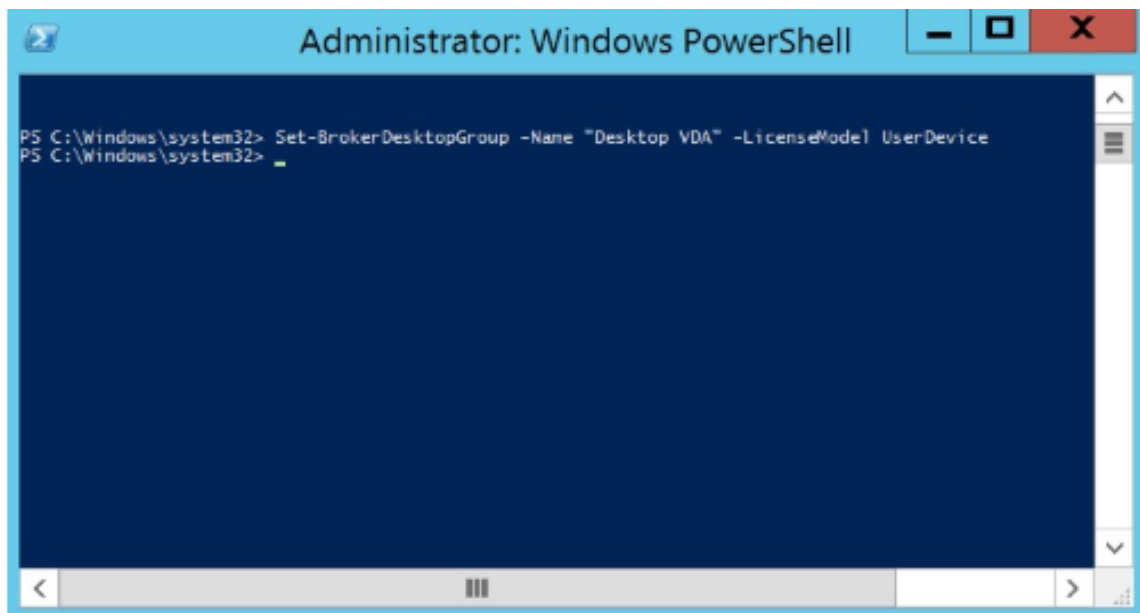

4. Change the license product by running the command: **Set-BrokerDesktopGroup -Name "DeliveryGroupName"-ProductCode ProductCode.**

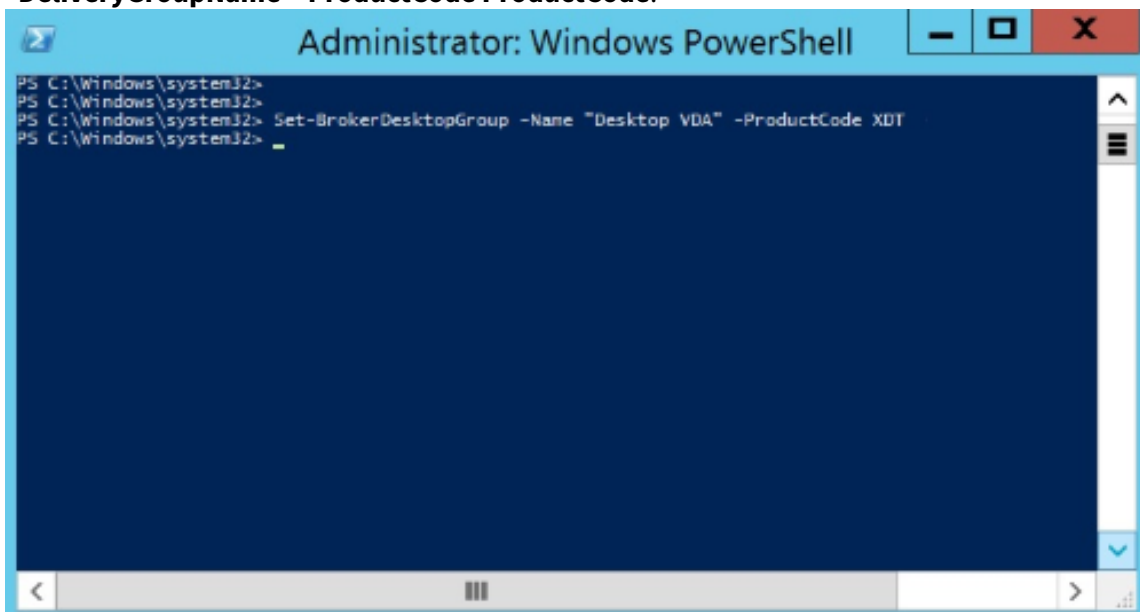

5. Enter the command **Get-BrokerDesktopGroup -Name "DeliveryGroupName"** to validate the changes.

**Note:**

You cannot mix and match editions in the same site. For example, Premium and Advanced licenses. Multiple sites are required if you have licenses with different editions.

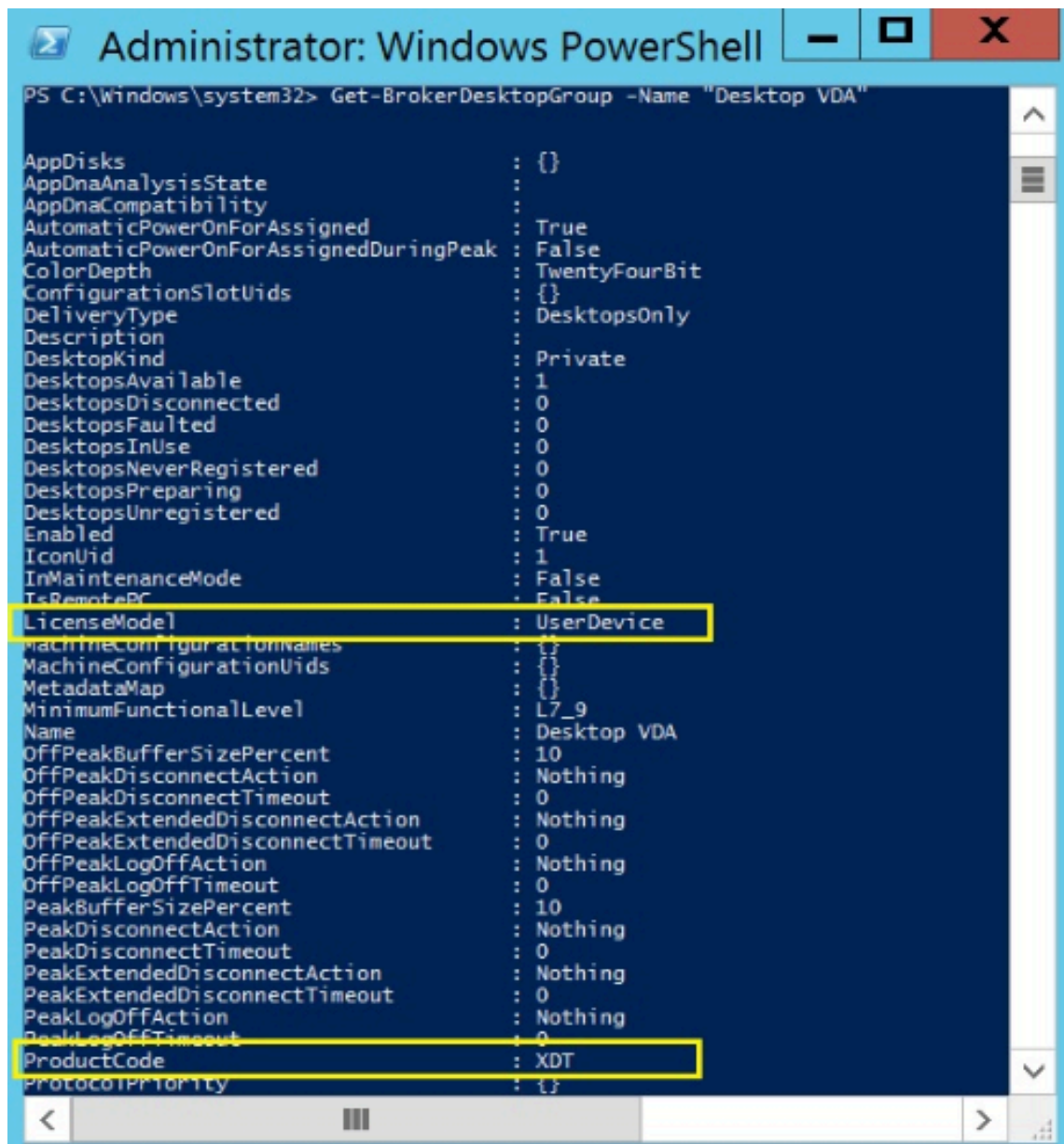

```
Administrator: Windows PowerShell
PS C:\Windows\system32> Get-BrokerDesktopGroup -Name "Desktop VDA"

AppDisks : {}
AppDnaAnalysisState :
AppDnaCompatibility :
AutomaticPowerOnForAssigned : True
AutomaticPowerOnForAssignedDuringPeak : False
ColorDepth : TwentyFourBit
ConfigurationSlotUids : {}
DeliveryType : DesktopsOnly
Description :
DesktopKind : Private
DesktopsAvailable : 1
DesktopsDisconnected : 0
DesktopsFaulted : 0
DesktopsInUse : 0
DesktopsNeverRegistered : 0
DesktopsPreparing : 0
DesktopsUnregistered : 0
Enabled : True
IconUid : 1
InMaintenanceMode : False
IsRemotePC : False
LicenseMode : UserDevice
MachineConfigurationNames : {}
MachineConfigurationUids : {}
MetadataMap : {}
MinimumFunctionalLevel : L7_9
Name : Desktop VDA
OffPeakBufferSizePercent : 10
OffPeakDisconnectAction : Nothing
OffPeakDisconnectTimeout : 0
OffPeakExtendedDisconnectAction : Nothing
OffPeakExtendedDisconnectTimeout : 0
OffPeakLogOffAction : Nothing
OffPeakLogOffTimeout : 0
PeakBufferSizePercent : 10
PeakDisconnectAction : Nothing
PeakDisconnectTimeout : 0
PeakExtendedDisconnectAction : Nothing
PeakExtendedDisconnectTimeout : 0
PeakLogOffAction : Nothing
PeakLogOffTimeout : 0
ProductCode : XDT
ProtocolPriority : {}
```

6. Remove the license configuration by running the same **Set-BrokerDesktopGroup** commands as described in previous steps, and set the value to **\$null**.

**Note:**

Studio doesn't display the license configuration for each delivery group. Use PowerShell to view the current configuration.



```

Administrator: Windows PowerShell
PS C:\Windows\system32> Set-BrokerDesktopGroup -Name "Desktop VDA" -LicenseModel $null
PS C:\Windows\system32> Set-BrokerDesktopGroup -Name "Desktop VDA" -ProductCode $null
PS C:\Windows\system32> Get-BrokerDesktopGroup -Name "Desktop VDA"

AppDisks : {}
AppDnaAnalysisState :
AppDnaCompatibility :
AutomaticPowerOnForAssigned : True
AutomaticPowerOnForAssignedDuringPeak : False
ColorDepth : TwentyFourBit
ConfigurationSlotUids : {}
DeliveryType : DesktopsOnly
Description :
DesktopKind : Private
DesktopsAvailable : 1
DesktopsDisconnected : 0
DesktopsFaulted : 0
DesktopsInUse : 0
DesktopsNeverRegistered : 0
DesktopsPreparing : 0
DesktopsUnregistered : 0
Enabled : True
IconUid : 1
InMaintenanceMode : False
IsRemotePC : False
LicenseModel :
MachineConfigurationNames : {}
MachineConfigurationUids : {}
MetadataMap : {}
MinimumFunctionalLevel : L7_9
Name : Desktop VDA
OffPeakBufferSizePercent : 10
OffPeakDisconnectAction : Nothing
OffPeakDisconnectTimeout : 0
OffPeakExtendedDisconnectAction : Nothing
OffPeakExtendedDisconnectTimeout : 0
OffPeakLogOffAction : Nothing
OffPeakLogOffTimeout : 0
PeakBufferSizePercent : 10
PeakDisconnectAction : Nothing
PeakDisconnectTimeout : 0
PeakExtendedDisconnectAction : Nothing
PeakExtendedDisconnectTimeout : 0
PeakLogOffAction : Nothing
PeakLogOffTimeout : 0
ProductCode :
ProtocolPriority : {}

```

## Example

This PowerShell cmdlet example illustrates setting multi-type licensing for two existing delivery groups and creates and sets a third delivery group.

To see the license product and license model associated with a delivery group, use the **Get-BrokerDesktopGroup** PowerShell cmdlet.

1. We set the first delivery group for XenApp and Concurrent.

**Set-BrokerDesktopGroup -Name "Delivery group for Citrix Virtual Apps Premium Concurrent"-ProductCode MPS -LicenseModel Concurrent**

2. We set the second delivery group for XenDesktop and Concurrent.

**Set-BrokerDesktopGroup -Name "Delivery group for Citrix Virtual Desktops Premium Concurrent"-ProductCode XDT -LicenseModel Concurrent**

3. We create and set the third delivery group for XenDesktop and UserDevice.

**New-BrokerDesktopGroup -Name “Delivery group for Citrix Virtual Desktops Premium UserDevice”-PublishedName “MyDesktop”-DesktopKind Private -ProductCode XDT -LicenseModel UserDevice**

## FAQ for licensing

December 6, 2023

### Note:

- For business continuity resources related to the COVID-19 pandemic, see [CTX27055](#).
- For general information about maintaining business continuity, see [Business continuity — on demand](#).
- For more information about the current Citrix License Server, see [Licensing](#).

## Citrix licensing

### How can I get my license file?

We send the license access code in an email. There are three ways to generate license files using the license access code:

- The **Manage Licenses** from your MyAccount page on [citrix.com](#). For more information, see [Manage licenses on citrix.com](#).
- Web Studio to allocate your purchase and the license file automatically installs on your Citrix License Server.
- Citrix Licensing Manager within the Citrix License Server to allocate your purchase and install your license file. For more information, see [Install licenses](#).

### How to allocate license on myaccount?

See [Allocate licenses](#).

### How to add allocated licenses to the license server?

See [Modify licenses](#).

### **What TCP ports does Citrix licensing use?**

- License Server port number is 27000
- Vendor daemon port number is 7279
- Management console web port is 8082
- Web Service for Licensing port is 8083

### **What is the Citrix License Server?**

The Citrix License Server is a system that allows licenses to be shared across the network. For more information, see [Licensing operations overview](#).

### **Can I virtualize or cluster the Citrix License Server?**

Yes. You can virtualize or cluster the Citrix License Server. For more information, see [Clustered License Servers](#).

### **What benefits are available to me if I virtualize the Citrix License Server?**

Virtualizing the Citrix License Server provides a redundant solution. That solution allows for mobility between multiple physical servers without the need for downtime.

### **Are there any limitations to consider if I virtualize the Citrix License Server?**

No.

### **Does the Citrix License Server manage all the licenses for my Citrix Virtual Apps and Desktops deployment?**

The Citrix License Server manages all licenses you receive for Citrix Virtual Apps and Desktop, except licenses in the Premium Edition used with Citrix Gateway. License servers built in to the network appliances as required for those security-oriented network devices manage those licenses.

### **What is the Citrix Licensing Manager?**

The Citrix Licensing Manager enables downloading and allocation of license files from the License Server on which you installed the Citrix Licensing Manager. The Citrix Licensing Manager is the recommended License Server management method, which enables the following:

- Short code registration of the License Server to Citrix Cloud and easy removal of registration.
- Configure user and group accounts.
- Use the dashboard to display installed, in-use, expired and available licenses, and Customer Success Services dates.
- Export license use data for use in reporting.
- Configure the historical use data retention period. Default data retention period is 180 days.
- Simplified installation of license files on the License Server using a license access code or downloaded file.
- Enable and disable the supplemental grace period.
- Configure Customer Experience Improvement Program (CEIP) and Call Home.
- Automatically or manually checks for Customer Success Services renewal licenses and notifies you or installs the licenses if found.
- Notifies you of the License Server state - Missing startup license, time issues, uploader failures.
- Modify these ports:
  - License Server (default 27000)
  - Vendor Daemon (default 7279)
  - Web Services for Licensing (default 8083)

For more information, see [Citrix Licensing Manager](#).

### **Where is the Citrix License Administration Console?**

The License Administration Console is no longer supported and was removed from the License Server version 11.16.6. We recommend you use the Citrix Licensing Manager.

You can use Studio to manage and track licensing, provided the License Server is in the same domain as Studio, or in a trusted domain.

For more information, see [Citrix Licensing Manager](#).

### **What is the license assignment period?**

The license assignment period is the term that a Citrix Virtual Apps and Desktops license is assigned to a user or device. The default license assignment period is 90 days.

### **How do I know how many licenses my organization has purchased?**

All purchased licenses are available to review and access at any time (24x7) from your secure **Manage Licenses** toolbox on your **My Account** page on <https://www.citrix.com>.

## **How do I know how many licenses are in use at any time?**

The Citrix Licensing Manager and Studio provide details on real time license use.

## **License Server disaster recovery and maintenance**

For information about disaster recovery and maintenance of your License Server, see [Disaster recovery and maintenance](#) in the Citrix Licensing documentation.

## **Citrix Virtual Apps and Desktops licensing**

### **How is Citrix Virtual Apps and Desktops licensed?**

The Citrix Virtual Apps and Desktops licensing offers user/device and concurrent license models.

#### **User/device:**

The flexible user/device model aligns with:

- Enterprise-wide desktop usage.
- Underlying Microsoft desktop virtualization licensing.
- Concurrent licensing for customers with users needing only occasional access to their virtual desktops and apps.

User/device licensing gives users access to their virtual desktops and apps from an unlimited number of devices. Device licenses give an unlimited number of user's access to their virtual desktops and apps from a single device. This approach provides you with maximum flexibility and improves alignment with Microsoft desktop virtualization licensing.

#### **Important:**

You can't manually allocate licenses to a user or device. The License Server or cloud service assigns licenses. With user/device licensing, once a license is assigned it can't be assigned to another user until after 90 days of inactivity.

#### **Concurrent:**

Concurrent licenses allow one connection to an unlimited number of virtual apps and desktops for any user and any device. A license is consumed only during an active session. If the session disconnects or is terminated, the license is checked back into the pool.

For more information about user/device licensing, see [User/device license](#) and concurrent licenses see, [Concurrent license](#).

### **Is it possible to try Citrix Virtual Apps and Desktops before purchasing licenses?**

Yes. You can download the Citrix Virtual Apps and Desktops software and run it in trial mode. Trial mode lets you use Citrix Virtual Apps and Desktops on-premises for 30 days, for 10 connections, without a license. For more information, see [Evaluation licenses](#).

Citrix DaaS (formerly Citrix Virtual Apps and Desktops service) for Citrix Cloud is available for trial service based on approval. Check with your Citrix representative for further details.

### **How does Citrix define concurrency for Citrix Virtual Apps and Desktops?**

The Citrix Virtual Apps and Desktops concurrent model allows one connection to an unlimited number of virtual apps and desktops for any user and any device. A license is consumed only during an active session. If the session disconnects or is terminated, the license is checked back into the pool for reissue. For more information, see [Concurrent license](#).

### **Can I deploy multiple editions of Citrix Virtual Apps and Desktops licenses on a common License Server?**

Yes. The License Server manages licenses for both Citrix Virtual Apps and Desktops simultaneously. We recommend that you install the latest License Server version. If you are unsure if your License Server version is current, verify it by comparing your version with the number on the [Citrix downloads site](#).

### **Can a single site use both Citrix Virtual Apps and Citrix Virtual Apps and Desktops licenses?**

Depending on the version, a single Citrix Virtual Apps or Citrix Virtual Apps and Desktops site can support both licensing models - user/device or concurrent. A single Citrix Virtual Apps or Citrix Virtual Apps and Desktops site can support only one edition. For more information, see [Multi-type licensing](#).

The minimum versions that support multi-type licensing are XenApp and XenDesktop 7.15 Long Term Service Release (LTSR) and Citrix Virtual Apps and Desktops 7 1808.

### **Can I select Citrix Virtual Apps concurrent as a product model if I have Citrix Virtual Apps and Desktops user/device or Citrix Virtual Apps and Desktops concurrent licenses installed on the License Server?**

If you use Citrix Virtual Apps as a feature of Citrix Virtual Apps and Desktops Advanced or Premium Edition, your Citrix Virtual Apps license model is the same as your Advanced or Premium Edition of Citrix Virtual Apps and Desktops. If you have purchased Citrix Virtual Apps and Desktops, configure your

licensing as Citrix Virtual Apps and Desktops even if you plan to use only the Citrix Virtual Apps functionality. Select Citrix Virtual Apps as a product model only if you have Citrix Virtual Apps concurrent standalone licenses installed on the License Server.

### **What product components are included with each Citrix Virtual Apps and Citrix Virtual Apps and Desktops edition?**

For a full feature matrix by edition, see [Citrix Virtual Apps and Desktops features](#).

### **How do I license Citrix Virtual Desktops environments in compliance with the Citrix Virtual Apps and Desktops EULA?**

To deploy Citrix Virtual Apps and Desktops under the user/device or the concurrent license model in compliance with the Citrix Virtual Apps and Desktops EULA, apply the license files to your License Server. The License Server then controls and monitors license compliance. We recommend that you configure your product based on what you purchased. For example, if you purchase Citrix Virtual Apps and Desktops Premium but only want to use the Citrix Virtual Apps feature, configure the product to Citrix Virtual Apps and Desktops to meet compliance. For more information, see the [Product License Compliance Center](#).

### **How do I license Citrix Virtual Apps environments in compliance with the Citrix Virtual Apps EULA?**

To deploy Citrix Virtual Apps under the concurrent license model in compliance with the Citrix Virtual Apps EULA, apply the license files to your License Server. The License Server then controls and monitors license compliance.

### **Is there a licensing requirement for Citrix Virtual Apps and Desktops Servicing Options: Long Term Service Release (LTSR) or Current Release (CR)?**

Citrix Virtual Apps and Desktops Servicing Options, such as Long-Term Service Release, are a benefit of the Customer Success Services program. You must have active Customer Success Services to qualify for the benefits of LTSR. For more information, see [Citrix Virtual Apps, [Citrix Virtual Apps and Desktops](#), and [XenServer Servicing Options](#)].

### **How do the Remote Browser Isolation (RBI) Service pooled hours work?**

When you purchase a minimum of 25 users of the service, you receive 5000 of hours of rights to use the service, pooled across all users. Subsequent purchases of user rights don't increase the pooled

hours entitlement. To increase the entitlement of service hours, buy add-on packs.

### **Can I use Remote PC Access with CCU licenses?**

Yes.

For information about Remote PC Access, see [Remote PC Access](#).

### **What happens when software maintenance expires for my Citrix environment?**

After a 30 day grace period, users will receive a warning message that your Citrix Virtual Apps and Desktops is unsupported after the session is launched.

Citrix Virtual Apps and Desktops warning:

Your corporate Citrix environment is currently unsupported. Please contact your IT department to resolve any support related issues.

## **User or device licenses**

### **How does Citrix allocate licenses to users in the user/device licensing model?**

With the user/device license model, the License Server assigns the license to a unique user ID. It allows that single user unlimited connections from unlimited devices. If a user connects to a desktop or device, the user requires one license assigned to that user to access a virtual desktop or application. The License Server or cloud service assigns the license. You can't assign these licenses manually. The license is assigned to the user, not the shared device. Once a license is assigned, it can't be assigned to another user until after 90 days of inactivity. For more information, see [User/Device license](#).

### **How does Citrix define a licensed device in the user/device licensing model?**

A licensed device requires a unique endpoint device ID. Under the user/device model, a device is any piece of equipment that you authorized for use by any individuals to access instances of Citrix Virtual Apps and Desktops. For a shared device, a single Citrix Virtual Apps and Desktops user/device license can support multiple users that share the device. For example, a shared device can be a classroom workstation or a clinical workstation in a hospital.

### **Can I convert my Citrix Virtual Desktops Standard Edition concurrent licenses to the user/device model?**

You cannot convert Citrix Virtual Desktops Standard Edition concurrent licenses to Citrix Virtual Desktops Standard Edition user/device licenses. Similarly, you cannot convert Citrix Virtual Desktops Stan-



Standard Edition user/device licenses to Citrix Virtual Desktops Standard Edition concurrent licenses.

If you have Citrix Virtual Desktops Standard Edition concurrent licenses and you want the user/device license model, upgrade to either Citrix Virtual Apps and Desktops Advanced or Premium Edition.

| From                                                          | To Standard concurrent                           | To Standard user/device                          | To Advanced user/device                                                                                                 | To Premium user/device                                                                                                  |
|---------------------------------------------------------------|--------------------------------------------------|--------------------------------------------------|-------------------------------------------------------------------------------------------------------------------------|-------------------------------------------------------------------------------------------------------------------------|
| Citrix Virtual Desktops Standard Edition concurrent licenses  | N/A                                              | Concurrent to user/device conversion NOT allowed | You cannot convert license models, but you can upgrade to Citrix Virtual Apps and Desktops Advanced or Premium Edition. | You cannot convert license models, but you can upgrade to Citrix Virtual Apps and Desktops Advanced or Premium Edition. |
| Citrix Virtual Desktops Standard Edition user/device licenses | User/device to concurrent conversion NOT allowed | N/A                                              | N/A                                                                                                                     | N/A                                                                                                                     |

### How does concurrent licensing work differently from user/device licensing?

We base concurrent licensing on concurrent device connections. A concurrent license is in use only when a device has established an active connection. Once the connection ends, the concurrent license returns to the license pool for immediate use. We recommend this licensing model for occasional usage. User/device licenses are leased for a period and are not available for other users until the lease expires.

### Under the user/device model, can we allocate licenses to both users and devices in the same enterprise?

Yes. Both types can be present in the same enterprise. The License Server optimally assigns licenses to users or devices based on usage. You can't assign these licenses manually.

### How do I decide how many users or devices to license?

Assess the use case requirements to determine the appropriate number of licenses. User/device licensing enables unlimited access to unlimited virtual desktops and virtual apps from an unlimited

number of devices. Concurrent licensing enables unlimited access to unlimited virtual desktops and virtual apps from a single device that an unlimited number of users can use. Consider the following formula:

```
1 (Number of total users) - (number of users that only access
2 exclusively
3 with shared devices) + (number shared devices) = total number
4 of licenses to buy.
5 For example, there are 1000 total users at the hospital. If 700 of them
6 access only
7 Citrix Virtual Desktops from 300 shared devices in the hospital, the
8 number of
9 licenses to purchase is 1000 - 700 + 300 = 600 licenses.
10 <!--NeedCopy-->
```

**Under the user/device model, what is the maximum number of devices a licensed user can use to connect to my environment?**

Each licensed user is entitled to use an unlimited number of connected or offline devices.

**Under the user/device model, what is the maximum number of users who can access a licensed device?**

Each licensed device can service an unlimited number of users within an organization.

**Under the user/device model, what is the maximum number of virtual desktops or RBI web applications a licensed user can consume at any given time?**

Each licensed user can connect to an unlimited number of virtual desktops or web applications.

**Can I purchase Citrix Virtual Apps and Desktops licenses to increase the number of licensed users/devices in my existing Citrix Virtual Apps and Desktops environment?**

Yes. You can purchase Citrix Virtual Apps and Desktops licenses to increase the number of licensed users/devices in your existing Citrix Virtual Apps and Desktops environment.

**How do I release an authorized user/device license?**

To release the assignment of an authorized user/device, use the `udadmin` utility in accordance with the EULA terms. The License Server then assigns the license to the next appropriate user/device. For more information, see [Display or release licenses for users or devices](#).

### **What happens if I exceed my purchased user/device license count?**

User/device licenses include a 10% overdraft, which is included when licenses are generated. The overdraft is also included in the installed license count. If the usage spike exceeds the installed count including overdraft, access for more users is denied. Purchase and deploy a new license to enable access for more users.

If all licenses are in use, including the license overdraft, the supplemental grace period enables unlimited connections to a product. The supplemental grace period gives you time to determine why you exceeded the maximum license count and to purchase more licenses without disrupting your users. This period lasts until 15 days elapses or you install more retail licenses, whichever comes first. For more information, see [Supplemental grace period](#).

Director displays the grace period states. For more information, see [Panels on the Director Dashboard](#).

### **What is the maximum number of virtual applications a licensed user can consume at any given time?**

Each licensed user can connect to an unlimited number of virtual applications.

### **What happens if a licensed user leaves my organization?**

When an existing licensed user leaves your organization, you can release the departing user's license without notifying Citrix. Use the `udadmin` utility to release the license. If you don't release the license, the License Server automatically releases any license after 90 days of inactivity. This information is subject to the terms specified in the EULA.

### **What happens if a licensed user is absent for a protracted period?**

If an existing licensed user is absent for a protracted period, you can release the license without notifying Citrix, so that it becomes available for reassignment. Use the `udadmin` utility to release the license.

### **What happens if we replace a licensed device in my organization?**

If you replace an existing licensed device, you can release the license without notifying Citrix so that it becomes available for reassignment. Use the `udadmin` utility to release the license.

### **What happens if a licensed device is out of service for an extended period?**

When an existing licensed device is out of service for an extended period, you can release the license without notifying Citrix, so that it becomes available for reassignment. Use the `udadmin` utility to release the licenses. If you don't release the license, the License Server automatically releases any license after 90 days of inactivity. This information is subject to the terms specified in the EULA.

### **Can I switch user licenses to device licenses and conversely after I've assigned the licenses to a device or user?**

Yes. This change happens automatically. The License Server assigns licenses to either users or devices based on usage patterns. If usage patterns change, the License Server might switch the assignment based on the new usage. The License Server always assigns licenses in the most economical fashion for the customer. Also, the License Server monitors licenses to identify **unused** licenses after their 90-day assignment period. You can reassign licenses identified as unused after the 90-day assignment period to other users or devices.

## **Concurrent licenses**

### **Under the concurrent model, what is the maximum number of virtual desktops a Citrix Virtual Apps and Desktops licensed user can consume at any given time?**

An endpoint can service many users and allows for unlimited connections.

### **Can I deploy concurrent licenses from a previous version of Citrix Virtual Apps and Desktops and new user/device or concurrent licenses to a single License Server?**

Yes. You can continue to use the same License Server to support user/device or concurrent licensed deployments.

### **Can I deploy concurrent licenses and user/device or concurrent licenses to a single License Server?**

Yes. You can continue to use the same License Server to support concurrent and user/device or concurrent licensed deployments.

## **Do Citrix Virtual Apps and Desktops Advanced and Premium editions include Citrix Virtual Apps concurrent licenses?**

Citrix Virtual Apps and Desktops Advanced and Premium user/device licenses include concurrent Citrix Virtual Apps licenses for compatibility only. These concurrent licenses are for use only with earlier product versions that are incompatible with user/device licenses. Use of the concurrent compatibility licenses included with user/device licenses is permissible only with these versions - XenApp versions earlier than 6.5 and XenDesktop versions earlier than 5.0 Service Pack 1.

## **What happens if I exceed my purchased concurrent license count?**

If all licenses are in use, the supplemental grace period enables unlimited connections to a product. The supplemental grace period gives you time to determine why you exceeded the maximum license count and to purchase more licenses without disrupting your users. This period lasts until 15 days elapses or you install more retail licenses, whichever comes first. For more information, see [Supplemental grace period](#).

Director displays the grace period states. For more information, see [Panels on the Director Dashboard](#).

## **Overdraft licenses**

### **How do I get overdraft licenses?**

Products (excluding Citrix Cloud) that support user/device, user, or device license models include a license overdraft feature that enables you to use a limited number of extra licenses to prevent access denial. We offer any overdraft feature as a convenience, not as a license entitlement. Concurrent and server licenses do not contain overdraft. Any overdraft licenses used must be purchased within 30 days of first use, but use is not limited to 30 days. Citrix reserves the right to remove any overdraft feature in new product releases. For more information, see [License overdraft](#).

### **How can I identify a license overdraft?**

You can view usage information, including the number of licenses in overdraft in the Citrix Licensing Manager. Studio also contains overdraft usage information.

### **What happens when an overdraft license is consumed?**

A license is assigned from your installed licenses to enable access to your Citrix Virtual Apps and Desktops environment. This overdraft license provides as much access and functionality as your other

licenses.

### **Can I get an alert when my overdraft licenses are consumed?**

Currently, there are no specific alerts provided when overdraft licenses are consumed.

### **How long can an overdraft license be consumed?**

Purchase any overdraft licenses used within 30 days of the first use.

### **Other product-specific licensing information**

- [Citrix ADC](#)
- [Citrix Cloud](#)
- [Citrix Endpoint Management](#)
- [Citrix Gateway](#)
- [XenServer](#)
- [Citrix Licensing](#)

## **Load balance machines**

November 14, 2023

#### **Note:**

This feature applies to all your catalogs—single-session OS or multi-session OS catalogs. Vertical load balancing applies only to multi-session OS machines.

Load balancing can be configured at the site level and at the delivery group level. You have two options: vertical and horizontal. By default, horizontal load balancing is enabled.

### **Load balancing settings at site level**

- **Vertical load balancing.** Assigns an incoming user session to the most loaded machine that has not yet reached the maximum load. This saturates existing machines before moving on to new machines. Users disconnecting from existing machines free up capacity on those machines. Incoming loads are then assigned to those machines. Vertical load balancing degrades the user experience but reduces costs (sessions maximize powered-on machine capacity).

Example: You have two machines configured for 10 sessions each. The first machine handles the first 10 concurrent sessions. The second machine handles the eleventh session.

**Tip:**

To specify the maximum number of sessions a machine can host, use the [Maximum number of sessions](#) policy setting.

Alternatively, you can use PowerShell to enable or disable vertical load balancing site-wide. Use the `UseVerticalScalingForRdsLaunches` setting in the `Set-BrokerSite` cmdlet. Use `Get-BrokerSite` to display the value of the `UseVerticalScalingForRdsLaunches` setting. See the cmdlet help for details.

- **Horizontal load balancing.** Assigns an incoming user session to the least-loaded, powered-on machine available. Horizontal load balancing improves the user experience but increases costs (because more machines are kept powered on). By default, horizontal load balancing is enabled.

Example: You have two machines configured for 10 sessions each. The first machine handles five concurrent sessions. The second machine also handles five.

To configure this feature, from **Manage > Full Configuration**, select **Settings** in the left pane. Select an option under **Load balance multi-session catalogs**.

## Load balancing settings at delivery group level

Configuring load balancing at the delivery group level allows you to override the load balancing settings inherited from the site level. You can achieve maximum utilization for each machine when you select vertical load balancing at the delivery group level. This will help reduce costs in public clouds. This configuration can be done during the creation of a new delivery group or editing an existing delivery group.

**Horizontal load balancing.** Sessions are distributed among powered-on machines. For example, if you have two machines configured for 10 sessions each, the first machine handles five concurrent sessions and the second machine also handles five.

**Vertical load balancing.** Sessions maximize powered-on machine capacity and save machine costs. For example, if you have two machines configured for 10 sessions each, the first machine handles the first 10 concurrent sessions. The second machine handles the eleventh session.

## Local Host Cache

April 1, 2024

To ensure that the Citrix Virtual Apps and Desktops site database is always available, Citrix recommends starting with a fault-tolerant SQL Server deployment, by following high availability best practices from Microsoft. (For supported SQL Server high availability features, see [Databases](#).) However, network issues and interruptions can result in users not being able to connect to their applications or desktops.

The Local Host Cache feature allows connection brokering operations in a site to continue when an outage occurs. An outage occurs when the connection between a Delivery Controller and the site database fails in an on-premises Citrix environment. Local Host Cache engages when the site database is inaccessible for 90 seconds.

As of XenApp and XenDesktop 7.16, the connection leasing feature (a predecessor high availability feature in earlier releases) was removed from the product, and is no longer available.

## Data content

Local Host Cache includes the following information, which is a subset of the information in the main database:

- Identities of users and groups who are assigned rights to resources published from the site.
- Identities of users who are currently using, or who have recently used, published resources from the site.
- Identities of VDA machines (including Remote PC Access machines) configured in the site.
- Identities (names and IP addresses) of client Citrix Receiver machines being actively used to connect to published resources.

It also contains information for currently active connections that were established while the main database was unavailable:

- Results of any client machine endpoint analysis performed by Citrix Receiver.
- Identities of infrastructure machines (such as NetScaler Gateway and StoreFront servers) involved with the site.
- Dates and times and types of recent activity by users.

## How it works

The following graphic illustrates the Local Host Cache components and communication paths during normal operations.



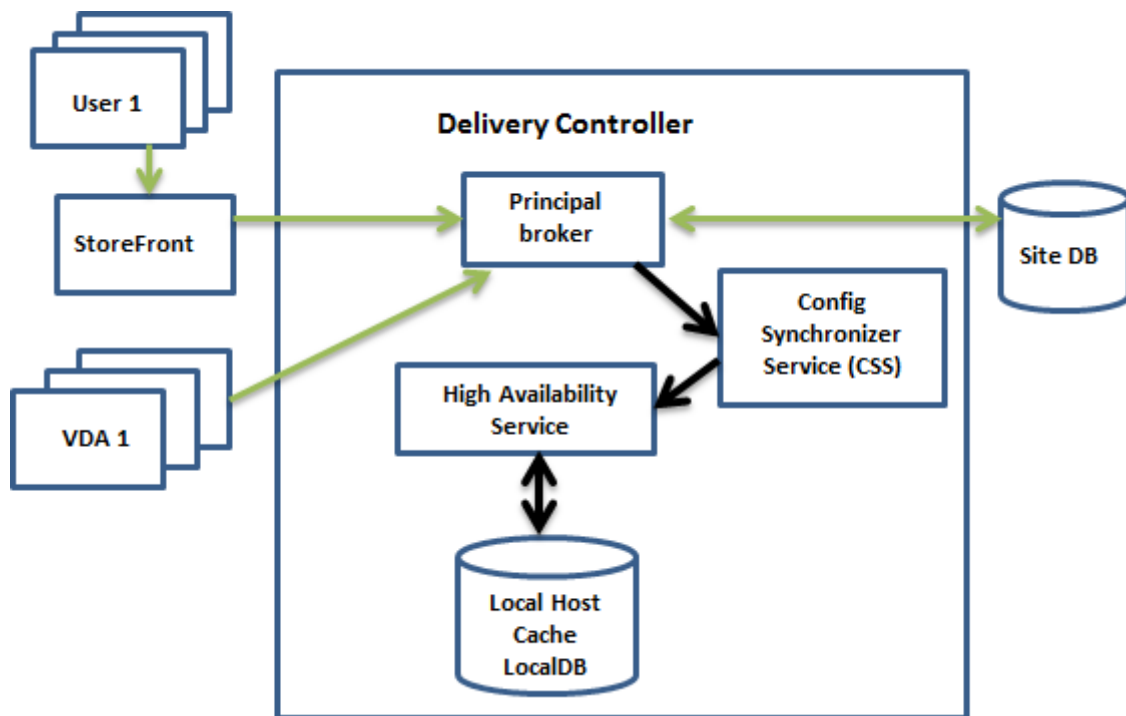

### During normal operations

- The *principal broker* (Citrix Broker Service) on a Controller accepts connection requests from StoreFront. The broker communicates with the site database to connect users with VDAs that are registered with the Controller.
- The Citrix Config Synchronizer Service (CSS) checks with the broker approximately every 5 minutes to see if any changes were made. Those changes can be administrator-initiated (such as changing a delivery group property) or system actions (such as machine assignments).
- If a configuration change occurred since the previous check, the CSS synchronizes (copies) information to a secondary broker on the Controller. (The secondary broker is also known as the High Availability Service.)

All configuration data is copied, not just items that changed since the previous check. The CSS imports the configuration data into a Microsoft SQL Server Express LocalDB database on the Controller. This database is referred to as the Local Host Cache database. The CSS ensures that the information in the Local Host Cache database matches the information in the site database. The Local Host Cache database is re-created each time synchronization occurs.

Microsoft SQL Server Express LocalDB (used by the Local Host Cache database) is installed automatically when you install a Controller. (You can prohibit this installed when installing a Controller from the command line.) The Local Host Cache database cannot be shared across Controllers. You do not need to back up the Local Host Cache database. It is recreated every time a

configuration change is detected.

- If no changes have occurred since the last check, no data is copied.

The following graphic illustrates the changes in communications paths if the principal broker loses contact with the site database (an outage begins).

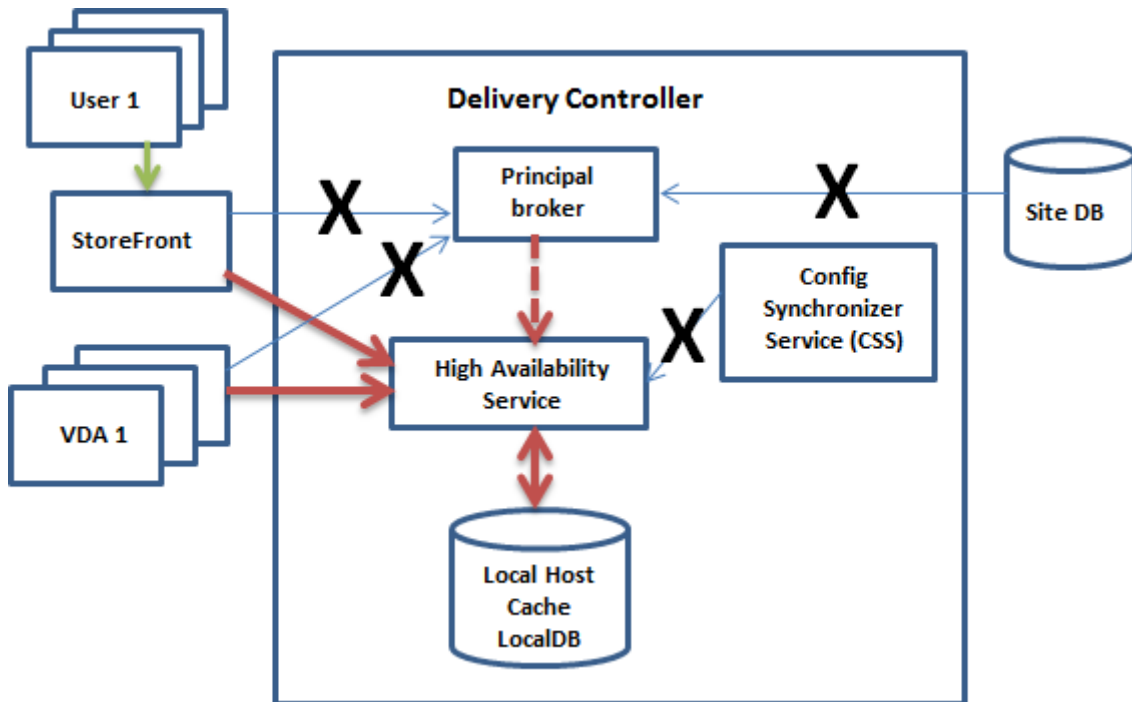

### During an outage

When an outage begins:

- The secondary broker starts listening for and processing connection requests.
- When the outage begins, the secondary broker does not have current VDA registration data, but when a VDA communicates with it, a registration process is triggered. During that process, the secondary broker also gets current session information about that VDA.
- While the secondary broker is handling connections, the Brokering Principal continues to monitor the connection. When the connection is restored, the Brokering Principal instructs the secondary broker to stop listening for connection information, and the Brokering Principal resumes brokering operations. The next time a VDA communicates with the Brokering Principal, a registration process is triggered. The secondary broker removes any remaining VDA registrations from the previous outage. The CSS resumes synchronizing information when it learns that configuration changes have occurred in the deployment.

In the unlikely event that an outage begins during a synchronization, the current import is discarded and the last known configuration is used.

The event log provides information about synchronizations and outages.

There is no time limit imposed for operating in outage mode.

The transition between normal and outage mode does not affect existing sessions. It affects only the launching of new sessions.

You can also intentionally trigger an outage. See [Force an outage](#) for details about why and how to do this.

### **Sites with multiple Controllers**

Among its other tasks, the CSS routinely provides the secondary broker with information about all Controllers in the zone. (If your deployment does not contain multiple zones, this action affects all Controllers in the site.) Having that information, each secondary broker knows about all peer secondary brokers running on other Controllers in the zone.

The secondary brokers communicate with each other on a separate channel. Those brokers use an alphabetical list of FQDN names of the machines they're running on to determine (elect) which secondary broker will be broker operations in the zone if an outage occurs. During the outage, all VDAs register with the elected secondary broker. The non-elected secondary brokers in the zone actively reject incoming connection and VDA registration requests.

If an elected secondary broker fails during an outage, another secondary broker is elected to take over, and VDAs register with the newly elected secondary broker.

During an outage, if a Controller is restarted:

- If that Controller is not the elected broker, the restart has no impact.
- If that Controller is the elected broker, a different Controller is elected, causing VDAs to register. After the restarted Controller powers on, it automatically takes over brokering, which causes VDAs to register again. In this scenario, performance can be affected during the registrations.

If you power off a Controller during normal operations and then power it on during an outage, Local Host Cache cannot be used on that Controller if it is elected as the broker.

The event logs provide information about elections.

### **What is unavailable during an outage, and other differences**

There is no time limit imposed for operating in outage mode. However, Citrix recommends restoring connectivity as quickly as possible.

During an outage:

- You cannot use Studio.

- You have limited access to the PowerShell SDK.
  - You must first:
    - \* Add a registry key `EnableCssTestMode` with a value of 1: `New-ItemProperty -Path HKLM:\SOFTWARE\Citrix\DesktopServer\LHC -Name EnableCssTestMode -PropertyType DWORD -Value 1`
    - \* Use port 89: `Get-BrokerMachine -AdminAddress localhost:89 | Select MachineName, ControllerDNSName, DesktopGroupName, RegistrationState`
  - After running those commands, you can access:
    - \* All `Get-Broker*` cmdlets.
- Hypervisor credentials cannot be obtained from the Host Service. All machines are in the unknown power state, and no power operations can be issued. However, VMs on the host that are powered-on can be used for connection requests.
- An assigned machine can be used only if the assignment occurred during normal operations. New assignments cannot be made during an outage.
- Automatic enrollment and configuration of Remote PC Access machines is not possible. However, machines that were enrolled and configured during normal operation are usable.
- Server-hosted applications and desktop users might use more sessions than their configured session limits, if the resources are in different zones.
- Users can launch applications and desktops only from registered VDAs in the zone containing the currently active/elected secondary broker. Launches across zones (from a secondary broker in one zone to a VDA in a different zone) are not supported during an outage.
- If a site database outage occurs before a scheduled restart begins for VDAs in a delivery group, the restarts begin when the outage ends. This can have unintended results. For more information, see [Scheduled restarts delayed due to database outage](#).
- [Zone preference](#) cannot be configured. If configured, preferences are not considered for session launch.
- [Tag restrictions](#) where tags are used to designate zones are not supported for session launches. When such tag restrictions are configured, and a StoreFront store's [advanced health check](#) option is enabled, sessions might intermittently fail to launch.

## Application and desktop support

Local Host Cache supports server-hosted applications and desktops, and static (assigned) desktops.

Local Host Cache supports desktop VDAs in pooled delivery groups, as follows:

- By default, power-managed desktop VDAs in pooled delivery groups (created by MCS or Citrix Provisioning) that have the `ShutdownDesktopsAfterUse` property enabled are not available for new connections during a Local Host Cache event. You can change this default, to allow those desktops to be used during Local Host Cache.

However, you cannot rely on the power management during the outage. (Power management resumes after normal operations resume.) Also, those desktops might contain data from the previous user, because they have not been restarted.

- To override the default behavior, it must be enabled site-wide and for each affected delivery group. Run the following PowerShell cmdlets.

Site-wide:

```
Set-BrokerSite -ReuseMachinesWithoutShutdownInOutageAllowed $true
```

For each affected delivery group, run the following PowerShell command:

```
Set-BrokerDesktopGroup -Name "name"-ReuseMachinesWithoutShutdownInOutage $true
```

To enable the delivery group setting by default, run the following PowerShell command:

```
Set-BrokerSite -DefaultReuseMachinesWithoutShutdownInOutage $true
```

This setting applies to all the new delivery groups that is created after enabling this setting.

To enable this setting for the existing delivery groups, run the following PowerShell command:

```
Set-BrokerDesktopGroup -Name "name"-ReuseMachinesWithoutShutdownInOutage $true
```

Enabling this feature in the site and the delivery groups does not affect how the configured `ShutdownDesktopsAfterUse` property works during normal operations. When this feature is enabled, VDAs do not automatically reboot after the LHC event is complete. Power-managed desktop VDAs in pooled delivery groups can retain data from previous sessions until the VDA is rebooted. This can occur when a user logs off of the VDA during non-LHC operations or the reboot can be triggered manually.

**Important:**

Without enabling `ReuseMachinesWithoutShutdownInOutageAllowed` at the Site level and `ReuseMachinesWithoutShutdownInOutage` at the delivery group level, all session launch attempts to power-managed desktop VDAs in pooled delivery groups will fail during a Local Host Cache event.

### **RAM size considerations**

The LocalDB service can use approximately 1.2 GB of RAM (up to 1 GB for the database cache, plus 200 MB for running SQL Server Express LocalDB). The secondary broker can use up to 1 GB of RAM if an outage lasts for an extended interval with many logons occurring (for example, 12 hours with 10K users). These memory requirements are in addition to the normal RAM requirements for the Controller, so you might need to increase the total amount of RAM capacity.

If you use a SQL Server Express installation for the site database, the server will have two sqlserver.exe processes.

### **CPU core and socket configuration considerations**

A Controller's CPU configuration, particularly the number of cores available to the SQL Server Express LocalDB, directly affects Local Host Cache performance, even more than memory allocation. This CPU overhead is observed only during the outage period when the database is unreachable and the secondary broker is active.

While LocalDB can use multiple cores (up to 4), it's limited to only a single socket. Adding more sockets will not improve the performance (for example, having 4 sockets with 1 core each). Instead, Citrix recommends using multiple sockets with multiple cores. In Citrix testing, a 2x3 (2 sockets, 3 cores) configuration provided better performance than 4x1 and 6x1 configurations.

### **Storage considerations**

As users access resources during an outage, the LocalDB grows. For example, during a logon/logoff test running at 10 logons per second, the database grew by 1 MB every 2-3 minutes. When normal operation resumes, the local database is recreated and the space is returned. However, sufficient space must be available on the drive where the LocalDB is installed to allow for the database growth during an outage. Local Host Cache also incurs more I/O during an outage: approximately 3 MB of writes per second, with several hundred thousand reads.

### **Performance considerations**

During an outage, one secondary broker handles all the connections, so in sites (or zones) that load balance among multiple Controllers during normal operations, the elected secondary broker might need to handle many more requests than normal during an outage. Therefore, CPU demands will be higher. Every secondary broker in the site (zone) must be able to handle the additional load imposed by the Local Host Cache database and all the affected VDAs, because the secondary broker elected during an outage can change.

VDI limits:

- In a single-zone VDI deployment, up to 10,000 VDAs can be handled effectively during an outage.
- In a multi-zone VDI deployment, up to 10,000 VDAs in each zone can be handled effectively during an outage, to a maximum of 40,000 VDAs in the site. For example, each of the following sites can be handled effectively during an outage:
  - A site with four zones, each containing 10,000 VDAs.
  - A site with seven zones, one containing 10,000 VDAs, and six containing 5,000 VDAs each.

During an outage, load management within the site can be affected. Load evaluators (and especially, session count rules) can be exceeded.

During the time it takes all VDAs to register with a secondary broker, that service might not have complete information about current sessions. So, a user connection request during that interval can result in a new session being launched, even though reconnection to an existing session was possible. This interval (while the “new” secondary broker acquires session information from all VDAs during re-registration) is unavoidable. Sessions that are connected when an outage starts are not impacted during the transition interval, but new sessions and session reconnections might be.

This interval occurs whenever VDAs must register:

- An outage starts: When migrating from a principal broker to a secondary broker.
- Secondary broker failure during an outage: When migrating from a secondary broker that failed to a newly elected secondary broker.
- Recovery from an outage: When normal operations resume, and the principal broker resumes control.

You can decrease the interval by lowering the Citrix Broker Protocol’s `HeartbeatPeriodMs` registry value (default = 600000 ms, which is 10 minutes). This heartbeat value is double the interval the VDA uses for pings, so the default value results in a ping every 5 minutes.

For example, the following command changes the heartbeat to five minutes (300000 milliseconds), which results in a ping every 2.5 minutes:

```
New-ItemProperty -Path HKLM:\SOFTWARE\Citrix\DesktopServer -Name
HeartbeatPeriodMs -PropertyType DWORD -Value 300000
```

Use caution when changing the heartbeat value. Increasing the frequency results in greater load on the Controllers during both normal and outage modes.

The interval cannot be eliminated entirely, no matter how quickly the VDAs register.

The time it takes to synchronize between secondary brokers increases with the number of objects (such as VDAs, applications, groups). For example, synchronizing 5000 VDAs might take 10 minutes or more to complete.

## Differences from XenApp 6.x releases

Although this Local Host Cache implementation shares the name of the Local Host Cache feature in XenApp 6.x and earlier XenApp releases, there are significant improvements. This implementation is more robust and immune to corruption. Maintenance requirements are minimized, such as eliminating the need for periodic `dsmaint` commands. This Local Host Cache is an entirely different implementation technically.

## Manage Local Host Cache

For Local Host Cache to work correctly, the PowerShell execution policy on each Controller must be set to RemoteSigned, Unrestricted, or Bypass.

## SQL Server Express LocalDB

The Microsoft SQL Server Express LocalDB software that Local Host Cache uses is installed automatically when you install a Controller or upgrade a Controller from a version earlier than 7.9. Only the secondary broker communicates with this database. You cannot use PowerShell cmdlets to change anything about this database. The LocalDB cannot be shared across Controllers.

The SQL Server Express LocalDB database software is installed regardless of whether Local Host Cache is enabled.

To prevent its installation, install or upgrade the Controller using the `XenDesktopServerSetup.exe` command, and include the `/exclude "Local Host Cache Storage (LocalDB)"` option. However, keep in mind that the Local Host Cache feature will not work without the database, and you cannot use a different database with the secondary broker.

Installation of this LocalDB database has no effect on whether you install SQL Server Express for use as the site database.

For information about replacing an earlier SQL Server Express LocalDB version with a newer version, see [Replace SQL Server Express LocalDB](#).

## Default settings after product installation and upgrade

During a new installation of Citrix Virtual Apps and Desktops (minimum version 7.16), Local Host Cache is enabled.

After an upgrade (to version 7.16 or later), Local Host Cache is enabled if there are fewer than 10,000 VDAs in the entire deployment.



## Enable and disable Local Host Cache

- To enable Local Host Cache, enter:

```
Set-BrokerSite -LocalHostCacheEnabled $true
```

To determine whether Local Host Cache is enabled, enter `Get-BrokerSite`. Check that the `LocalHostCacheEnabled` property is `True`.

- To disable Local Host Cache, enter:

```
Set-BrokerSite -LocalHostCacheEnabled $false
```

Remember: As of XenApp and XenDesktop 7.16, connection leasing (the feature that preceded Local Host Cache beginning with version 7.6) was removed from the product, and is no longer available.

## Verify that Local Host Cache is working

To verify that Local Host Cache is set up and working correctly:

- Ensure that synchronization imports complete successfully. Check the event logs.
- Ensure that the SQL Server Express LocalDB database was created on each Delivery Controller. This confirms that the secondary broker can take over, if needed.
  - On the Delivery Controller server, browse to `C:\Windows\ServiceProfiles\NetworkService`.
  - Verify that `HaDatabaseName.mdf` and `HaDatabaseName_log.ldf` are created.
- Force an outage on the Delivery Controllers. After you've verified that Local Host Cache works, remember to place all the Controllers back into normal mode. This can take approximately 15 minutes.

## Event logs

Event logs indicate when synchronizations and outages occur. In event viewer logs, outage mode is referred to as *HA mode*.\*

### Config Synchronizer Service:

During normal operations, the following events can occur when the CSS imports the configuration data into the Local Host Cache database using the Local Host Cache broker.

- 503: The Citrix Config Sync Service received an updated configuration. This event indicates the start of the synchronization process.
- 504: The Citrix Config Sync Service imported an updated configuration. The configuration import completed successfully.

- 505: The Citrix Config Sync Service failed an import. The configuration import did not complete successfully. If a previous successful configuration is available, it is used if an outage occurs. However, it will be out-of-date from the current configuration. If there is no previous configuration available, the service cannot participate in session brokering during an outage. In this case, see the Troubleshoot section, and contact Citrix Support.
- 507: The Citrix Config Sync Service abandoned an import because the system is in outage mode and the Local Host Cache broker is being used for brokering. The service received a new configuration, but the import was abandoned because an outage occurred. This is expected behavior.
- 510: No Configuration Service configuration data received from primary Configuration Service.
- 517: There was a problem communicating with the primary Broker.
- 518: Config Sync script aborted because the secondary Broker (High Availability Service) is not running.

### **High Availability Service:**

This service is also known as the Local Host Cache broker.

- 3502: An outage occurred and the Local Host Cache broker is performing brokering operations.
- 3503: An outage was resolved and normal operations have resumed.
- 3504: Indicates which Local Host Cache broker is elected, plus other Local Host Cache brokers involved in the election.
- 3507: Provides a status update of Local Host Cache every 2 minutes which indicates that Local Host Cache mode is active on the elected broker. Contains a summary of the outage including outage duration, VDA registration, and session information.
- 3508: Announces Local Host Cache is no longer active on the elected broker and normal operations have been restored. Contains a summary of the outage including outage duration, number of machines that registered during the Local Host Cache event, and number of successful launches during the LHC event.
- 3509: Notifies that Local Host Cache is active on the non-elected broker(s). Contains an outage duration every 2 minutes and indicates the elected broker.
- 3510: Announces Local Host Cache is no longer active on the non-elected broker(s). Contains the outage duration and indicates the elected broker.

### **Force an outage**

You might want to deliberately force an outage.

- If your network is going up and down repeatedly. Forcing an outage until the network issues are resolved prevents continuous transition between normal and outage modes (and the resulting frequent VDA registration storms).
- To test a disaster recovery plan.

- To help ensure that Local Host Cache is working correctly.
- While replacing or servicing the site database server.

To force an outage, edit the registry of each server containing a Delivery Controller. In `HKLM\Software\Citrix\DesktopServer\LHC`, create and set `OutageModeForced` as `REG_DWORD` to 1. This setting instructs the Local Host Cache broker to enter outage mode, regardless of the state of the database. Setting the value to 0 takes the Local Host Cache broker out of outage mode.

To verify events, monitor the `Current_HighAvailabilityService` log file in `C:\ProgramData\Citrix\WorkspaceCloud\Logs\Plugins\HighAvailabilityService`.

## Troubleshoot

Several troubleshooting tools are available when a synchronization import to the Local Host Cache database fails and a 505 event is posted.

**CDF tracing:** Contains options for the `ConfigSyncServer` and `BrokerLHC` modules. Those options, along with other broker modules, will likely identify the problem.

**Report:** If a synchronization import fails, you can generate a report. This report stops at the object causing the error. This report feature affects synchronization speed, so Citrix recommends disabling it when not in use.

To enable and produce a CSS trace report, enter the following command:

```
New-ItemProperty -Path HKLM:\SOFTWARE\Citrix\DesktopServer\LHC -Name EnableCssTraceMode -PropertyType DWORD -Value 1
```

The HTML report is posted at `C:\Windows\ServiceProfiles\NetworkService\AppData\Local\Temp\CitrixBrokerConfigSyncReport.html`.

After the report is generated, enter the following command to disable the reporting feature:

```
Set-ItemProperty -Path HKLM:\SOFTWARE\Citrix\DesktopServer\LHC -Name EnableCssTraceMode -Value 0
```

**Export the broker configuration:** Provides the exact configuration for debugging purposes.

```
Export-BrokerConfiguration | Out-File <file-pathname>
```

For example, `Export-BrokerConfiguration | Out-File C:\\BrokerConfig.xml`.

## Local Host Cache PowerShell commands

You can manage Local Host Cache(LHC) on your Delivery Controllers using PowerShell commands.

The PowerShell module is located at the following location on the Delivery Controllers:

`C:\Program Files\Citrix\Broker\Service\ControlScripts`

**Important:**

Run this module only on the Delivery Controllers.

**Import PowerShell module** To import the module, run the following on your Delivery Controller.

```
cd C:\Program Files\Citrix\Broker\Service\ControlScripts Import-Module .\HighAvailabilityServiceControl.psm1
```

**PowerShell commands to manage LHC** The following commands help you to activate and manage the LHC mode on the Delivery Controllers.

---

| Cmdlets                                  | Function                                                                                                                                                                                                                                                                                                                                                        |
|------------------------------------------|-----------------------------------------------------------------------------------------------------------------------------------------------------------------------------------------------------------------------------------------------------------------------------------------------------------------------------------------------------------------|
| <code>Enable-LhcForcedOutageMode</code>  | Place the Broker in LHC mode. LHC database files must have been successfully created by the ConfigSync Service for <code>Enable-LhcForcedOutageMode</code> to function properly. This cmdlet only forces LHC on the Delivery Controller that it was run on. For LHC to become active, this command must be run on all the Delivery Controllers within the zone. |
| <code>Disable-LhcForcedOutageMode</code> | Takes the Broker out of the LHC mode. This cmdlet only disables LHC mode on the Delivery Controller that it was run on. <code>Disable-LhcForcedOutageMode</code> must be run on all the Delivery Controllers within the zone.                                                                                                                                   |

| Cmdlets                                          | Function                                                                                                                                                                                                                                                                                                                                                                                                                                                                     |
|--------------------------------------------------|------------------------------------------------------------------------------------------------------------------------------------------------------------------------------------------------------------------------------------------------------------------------------------------------------------------------------------------------------------------------------------------------------------------------------------------------------------------------------|
| <code>Set-LhcConfigSyncIntervalOverride</code>   | Sets the interval at which the Citrix Config Synchronizer Service (CSS) checks for configuration changes within the site. The time interval can range from 60 seconds (one minute) to 3600 seconds (one hour). This setting only applies to the Delivery Controller on which it was run. For consistency across Delivery Controllers, consider running this cmdlet on each Delivery Controller. For example:<br><code>Set-LhcConfigSyncIntervalOverride -Seconds 1200</code> |
| <code>Clear-LhcConfigSyncIntervalOverride</code> | Sets the interval at which the Citrix Config Synchronizer Service (CSS) checks for configuration changes within the site to the default value of 300 seconds (five minutes). This setting only applies to the Delivery Controller on which it was run. For consistency across Delivery Controllers, consider running this cmdlet on each Delivery Controller.                                                                                                                |
| <code>Enable-LhcHighAvailabilitySDK</code>       | Enables access to all the <code>Get-Broker*</code> cmdlets within the Delivery Controller that it was run on.                                                                                                                                                                                                                                                                                                                                                                |
| <code>Disable-LhcHighAvailabilitySDK</code>      | Disables access to the Broker cmdlets within the Delivery Controller that it was run on.                                                                                                                                                                                                                                                                                                                                                                                     |

**Note:**

- Use port 89 when running the `Get-Broker*` cmdlets on the Delivery Controller. For example:
  - `Get-BrokerMachine -AdminAddress localhost:89`
- When not in LHC mode, the LHC Broker on the Delivery Controller only holds configuration information.
- During LHC mode, the LHC Broker on the elected Delivery Controller holds the following information:
  - Resource states
  - Session details

- VDA registrations
- Configuration information

## Manage security keys

March 23, 2023

### Important:

- You must use this feature in combination with StoreFront 1912 LTSR CU2 or later.
- The Secure XML feature is only supported on Citrix ADC and Citrix Gateway release 12.1 and later.

### Note:

You can manage your Citrix Virtual Apps and Desktops deployment using two management consoles: Web Studio (web-based) and Citrix Studio (Windows-based). This article covers only Web Studio. For information about Citrix Studio, see the equivalent article in Citrix Virtual Apps and Desktops 7 2212 or earlier.

This feature lets you allow only approved StoreFront and Citrix Gateway machines to communicate with Delivery Controllers. After you enable this feature, any requests that do not contain the key are blocked. Use this feature to add an extra layer of security to protect against attacks originating from the internal network.

A general workflow to use this feature is as follows:

1. Enable Web Studio to show the feature settings.
2. Configure settings for your site.
3. Configure settings for StoreFront.
4. Configure settings for Citrix ADC.

### Enable Web Studio to show the feature settings

By default, settings for security keys are hidden from Web Studio. To enable Web Studio to show them, use the PowerShell SDK as follows:

1. Run the Citrix Virtual Apps and Desktops PowerShell SDK.
2. In a command window, run the following commands:

- `Add-PSSnapIn Citrix*`. This command adds the Citrix snap-ins.
- `Set-ConfigSiteMetadata -Name "Citrix_DesktopStudio_SecurityKeyManagement" -Value "True"`

For more information about the PowerShell SDK, see [SDKs and APIs](#).

## Configure settings for the site

You can use Web Studio or PowerShell to configure security key settings for your site.

### Use Web Studio

1. Sign in to Web Studio, select **Settings** in the left pane.
2. Locate the **Manage security key** tile and click **Edit**. The **Manage Security Key** page appears.

**Manage Security Key** ×

This feature lets you manage the security key used to authenticate Citrix Gateway and StoreFront when they communicate with the Delivery Controller. [Learn more](#)

Key1:

Key2:

Require key for communications over XML port (StoreFront only) ?

Require key for communications over STA port ?

3. Click the refresh icon to generate the keys.

#### Important:

- There are two keys available for use. You can use the same key or different keys for communications over the XML and STA ports. We recommend that you use only one key at a time. The unused key is used only for key rotation.
- Do not click the refresh icon to update the key already in use. If you do, service interruption will occur.

4. Select where a key is required for communications:
  - **Require key for communications over XML port (StoreFront only).** If selected, require a key to authenticate communications over the XML port. StoreFront communicates with Citrix Cloud over this port. For information about changing the XML port, see Knowledge Center article [CTX127945](#).
  - **Require key for communications over STA port.** If selected, require a key to authenticate communications over the STA port. Citrix Gateway and StoreFront communicate with Citrix Cloud over this port. For information about changing the STA port, see Knowledge Center article [CTX101988](#).
5. Click **Save** to apply your changes and close the window.

## Use PowerShell

The following are PowerShell steps equivalent to Web Studio operations.

1. Run the Citrix Virtual Apps and Desktops Remote PowerShell SDK.
2. In a command window, run the following command:
  - `Add-PSSnapIn Citrix*`
3. Run the following commands to generate a key and set up Key1:
  - `New-BrokerXmlServiceKey`
  - `Set-BrokerSite -XmlServiceKey1 <the key you generated>`
4. Run the following commands to generate a key and set up Key2:
  - `New-BrokerXmlServiceKey`
  - `Set-BrokerSite -XmlServiceKey2 <the key you generated>`
5. Run one or both of the following commands to enable the use of a key in authenticating communications:
  - To authenticate communications over the XML port:
    - `Set-BrokerSite -RequireXmlServiceKeyForNFuse $true`
  - To authenticate communications over the STA port:
    - `Set-BrokerSite -RequireXmlServiceKeyForSta $true`

See the PowerShell command help for guidance and syntax.



## Configure settings for StoreFront

After completing the configuration for your site, you need to configure relevant settings for StoreFront by using PowerShell.

On the StoreFront server, run the following PowerShell commands:

- To configure the key for communications over the XML port, use the `Get-STFStoreService` and `Set-STFStoreService` commands. For example:
  - `PS C:\> Set-STFStoreFarm $farm -Farmtype XenDesktop -Port 80 -TransportType HTTP -Servers <domain name1, domain name2> -XMLValidationEnabled $true -XMLValidationSecret <the key you generated in Web Studio>`
- To configure the key for communications over the STA port, use the `New-STFSecureTicketAuthority` command. For example:
  - `PS C:\> $sta = New-STFSecureTicketAuthority -StaUrl <STA URL> -StaValidationEnabled $true -StavalidationSecret <the key you generated in Web Studio>`

See the PowerShell command help for guidance and syntax.

## Configure settings for Citrix ADC

### Note:

Configuring this feature for Citrix ADC is not required unless you use Citrix ADC as your gateway. If you use Citrix ADC, follow these steps:

1. Ensure that the following prerequisite configuration is already in place:
  - The following Citrix ADC related IP addresses are configured.
    - Citrix ADC Management IP (NSIP) address for accessing the Citrix ADC console. For details, see [Configuring the NSIP address](#).

- Subnet IP (SNIP) address for enabling communication between the Citrix ADC appliance and the back-end servers. For details, see [Configuring Subnet IP Addresses](#).
- Citrix Gateway virtual IP address and load balancer virtual IP address to log in to the ADC appliance for session launch. For details, see [Create a virtual server](#).

- The required modes and features in the Citrix ADC appliance are enabled.
  - To enable the modes, in the Citrix ADC GUI navigate to **System > Settings > Configure Mode**.
  - To enable the features, in the Citrix ADC GUI navigate to **System > Settings > Configure Basic Features**.
- Certificates related configurations are complete.
  - The Certificate Signing Request (CSR) is created. For details, see [Create a certificate](#).

Dashboard Configuration Reporting Documentation

### ← Create RSA Key

Key Filename\*  
  ⓘ

Key Size(bits)\*

Public Exponent Value\*

Key Format\*

PEM Encoding Algorithm

PEM Passphrase

Confirm PEM Passphrase

PKCS8

- The server and CA certificates and root certificates are installed. For details, see [Install, link, and updates.](#)

Dashboard Configuration Reporting Documentation Downloads

### ← Install Server Certificate

Certificate-Key Pair Name\*  
 ⓘ

Certificate File Name\*  
  ⓘ

Key File Name  
  ⓘ

Notify When Expires

2 SNMP Trap destination found.

Notification Period

Dashboard Configuration Reporting Documentation Downloads

### ← Install CA Certificate

Certificate-Key Pair Name\*  
 ⓘ

Certificate File Name\*  
  ⓘ

Notify When Expires

2 SNMP Trap destination found.

Notification Period

- A Citrix Gateway has been created for Citrix Virtual Desktops. Test the connectivity by clicking the **Test STA Connectivity** button to confirm that the virtual servers are online. For details, see [Setting up Citrix ADC for Citrix Virtual Apps and Desktops](#).

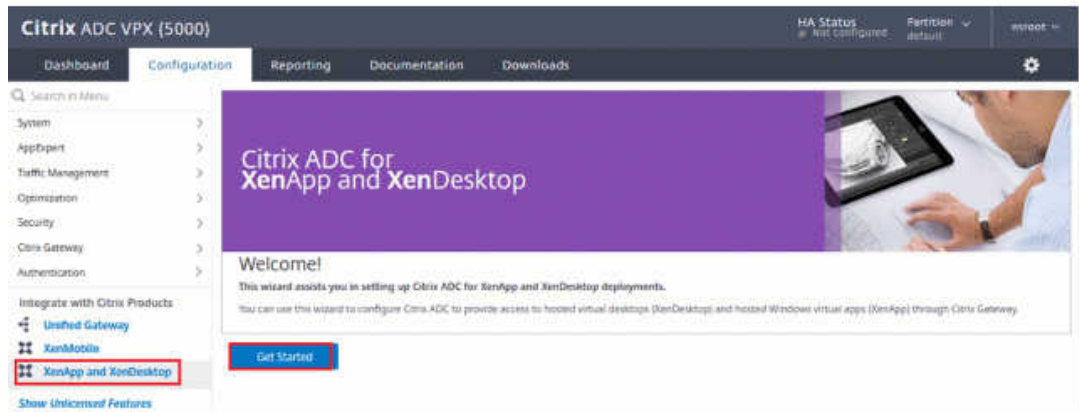

2. Add a rewrite action. For details, see [Configuring a Rewrite Action](#).

- Navigate to **AppExpert > Rewrite > Actions**.
- Click **Add** to add a new rewrite action. You can name the action as “set Type to INSERT\_HTTP\_HEADER”.

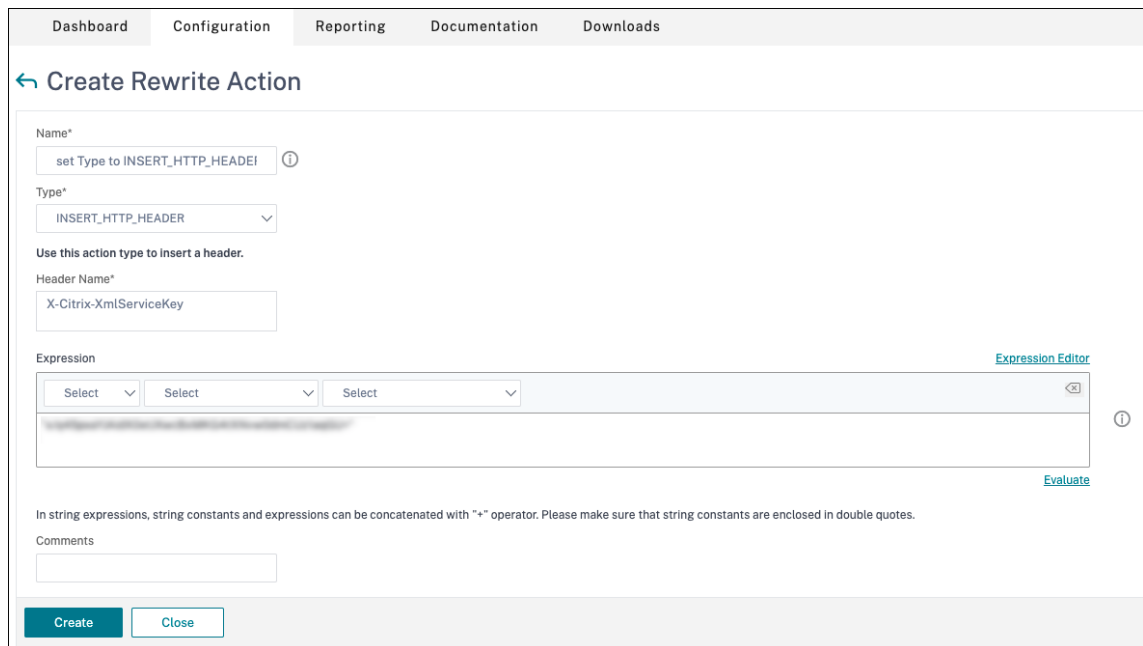

- In **Type**, select **INSERT\_HTTP\_HEADER**.

- b) In **Header Name**, enter X-Citrix-XmlServiceKey.
- c) In **Expression**, add <XmlServiceKey1 value> with the quotes. You can copy the XmlServiceKey1 value from your Desktop Delivery Controller configuration.

```
PS C:\Users\tyadmin> Get-BrokerSite

BaseOU :
BrokerServiceGroupUid :
ColorDepth :
ConfigLastChangeTime :
ConfigurationServiceGroupUid :
ConnectionLeasingEnabled :
DefaultMinimumFunctionalLevel :
DesktopGroupIconUid :
DnsResolutionEnabled :
IsSecondaryBroker :
LicenseEdition :
LicenseGraceSessionsRemaining :
LicenseModel :
LicenseServerName :
LicenseServerPort :
LicensedSessionsActive :
LicensingBurnIn :
LicensingBurnInDate :
LicensingGraceHoursLeft :
LicensingGracePeriodActive :
LicensingOutOfBoxGracePeriodActive :
LocalHostCacheEnabled :
MetadataMap :
Name :
PeakConcurrentLicenseUsers :
RequireXmlServiceKeyForNFuse :
RequireXmlServiceKeyForSta :
ReuseMachinesWithoutShutdownInOutageAllowed :
SecureIcaRequired :
TotalUniqueLicenseUsers :
TrustManagedAnonymousXmlServiceRequests :
TrustRequestsSentToTheXmlServicePort :
UseVerticalScalingForRdsLaunches :
XmlServiceKey1 :
XmlServiceKey2 :
```

3. Add a rewrite policy. For details, see [Configuring a Rewrite Policy](#).

- a) Navigate to **AppExpert > Rewrite > Policies**.
- b) Click **Add** to add a new policy.

Dashboard Configuration **Reporting** Documentation Downloads

← Create Rewrite Policy

Name\*  
DDCPolicy ⓘ

Action\*  
set Type to INSERT\_HTTP\_HEADER ⓘ

Configure Assignments  
Configure Rewrite Actions

Log Action  
⌵ Add Edit ⓘ

Undefined-Result Action\*  
-Global-undefined-result-action- ⌵

Expression\* [Expression Editor](#)  
 Select ⌵ Select ⌵ Select ⌵  ⓘ  
[Evaluate](#)

Comments  
 ⓘ

Create Close

- a) In **Action**, select the action created in the earlier step.
  - b) In **Expression**, add HTTP.REQ.IS\_VALID.
  - c) Click **OK**.
4. Set up load balancing. You must configure one load balancing virtual server per STA server. If not the sessions fail to launch.

For details, see [Set up basic load balancing](#).

- a) Create a load balancing virtual server.
  - Navigate to **Traffic Management > Load Balancing > Servers**.
  - In **Virtual Servers** page, click **Add**.

← Load Balancing Virtual Server

**Basic Settings**

Create a virtual server by specifying a name, an IP address, a port, and a protocol type. If an application is accessible from the Internet, the virtual server IP (VIP) address is a public IP address. If the application is accessible only from the local area network (LAN) or wide area network (WAN), the VIP is usually a private (RFC1918) IP address. You can configure multiple virtual servers to receive client requests, thereby increasing the availability of resources to process client requests.

Name\*  
 ⓘ

Protocol\*

IP Address Type\*  
 ⓘ

IP Address\*  
 ⓘ

Port\*

▶ More

- In **Protocol**, select **HTTP**.
- Add the load balancing virtual IP address and in **Port** select **80**.
- Click **OK**.

b) Create a load balancing service.

- Navigate to **Traffic Management > Load Balancing > Services**.

← Load Balancing Service

**Basic Settings**

Service Name\*  
 ⓘ

New Server  Existing Server

Server\*

Protocol\*

Port\*

▶ More

- In **Existing Server**, select the virtual server created in the previous step.
  - In **Protocol**, select **HTTP** and in **Port** select **80**.
  - Click **OK**, and then click **Done**.
- c) Bind the service to the virtual server.
- Select the virtual server created earlier and click **Edit**.
  - In **Services and Service Groups**, click **No Load Balancing Virtual Server Service Binding**.

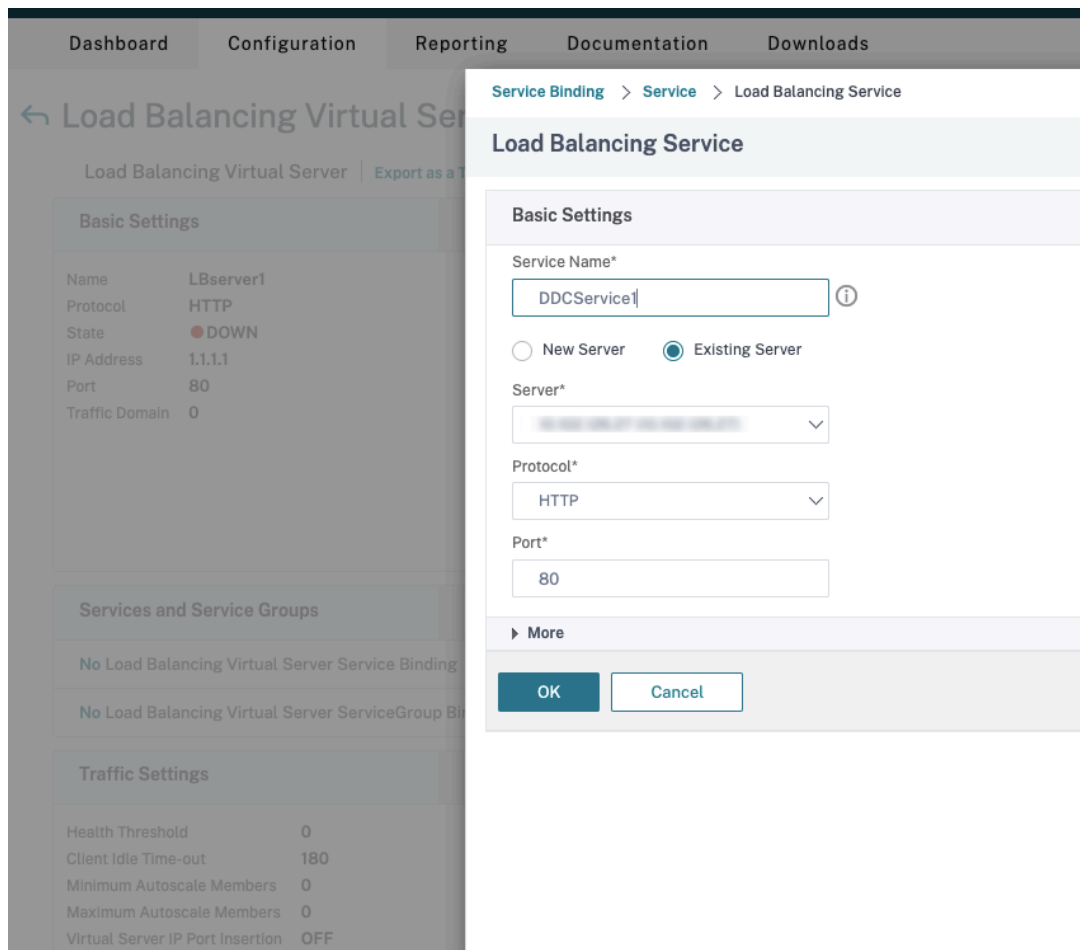

- In **Service Binding**, select the service created earlier.
  - Click **Bind**.
- d) Bind the rewrite policy created earlier to the virtual server.
- Select the virtual server created earlier and click **Edit**.
  - In **Advanced Settings**, click **Policies**, and then in **Policies** section click **+**.



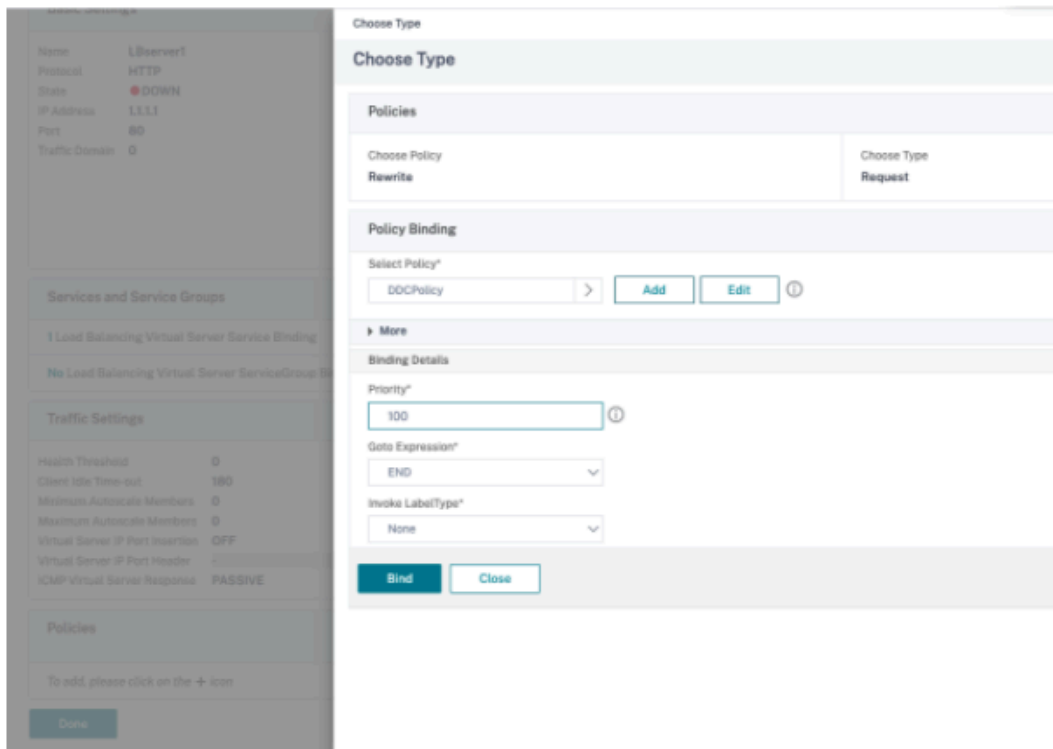

- In **Choose Policy**, select **Rewrite** and in **Choose Type**, select **Request**.
- Click **Continue**.
- In **Select Policy**, select the rewrite policy created earlier.
- Click **Bind**.
- Click **Done**.

e) Set up persistence for the virtual server, if necessary.

- Select the virtual server created earlier and click **Edit**.
- In **Advanced Settings**, click **Persistence**.

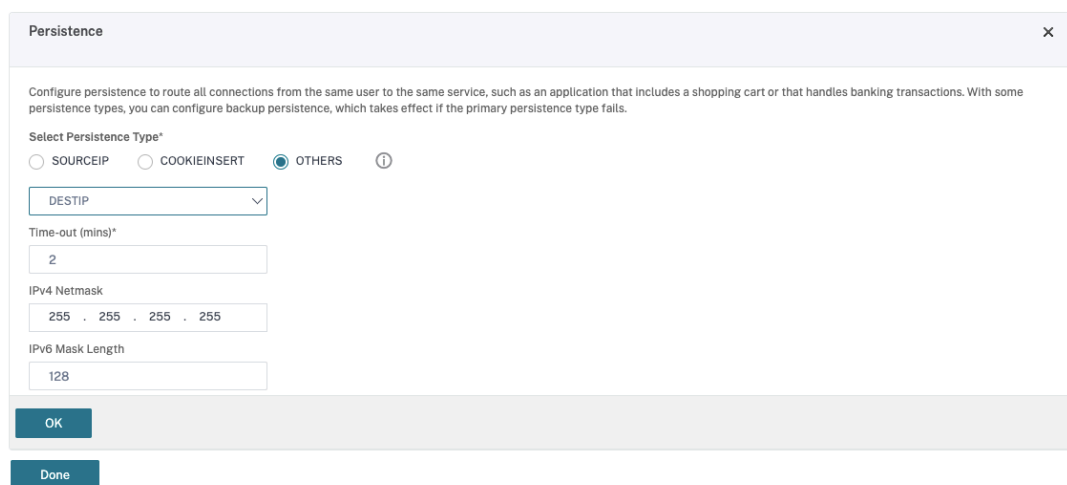

- Select persistence type as **Others**.

- Select **DESTIP** to create persistence sessions based on the IP address of the service selected by the virtual server (the destination IP address)
- In **IPv4 Netmask**, add network mask same as that of the DDC.
- Click **OK**.

f) Repeat these steps for the other virtual server as well.

### Configuration changes if the Citrix ADC appliance is already configured with Citrix Virtual Desktops

If you have already configured the Citrix ADC appliance with Citrix Virtual Desktops, then to use the Secure XML feature, you must make the following configuration changes.

- Before the session launch, change the **Security Ticket Authority URL** of the gateway to use the FQDNs of the load balancing virtual servers.
- Ensure that the `TrustRequestsSentToTheXmlServicePort` parameter is set to False. By default, `TrustRequestsSentToTheXmlServicePort` parameter is set to False. However, if the customer has already configured the Citrix ADC for Citrix Virtual Desktops, then the `TrustRequestsSentToTheXmlServicePort` is set to True.

1. In the Citrix ADC GUI, navigate to **Configuration > Integrate with Citrix Products** and click **XenApp and XenDesktop**.
2. Select the gateway instance and click the edit icon.

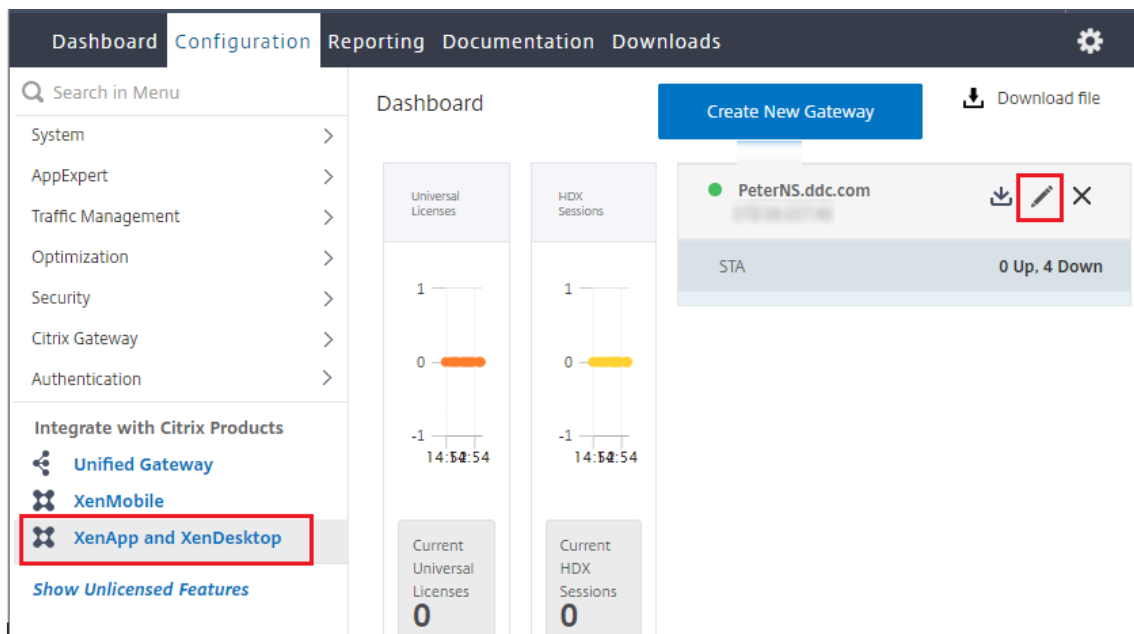

3. In the StoreFront pane, click the edit icon.

| StoreFront                                         |                             |  |
|----------------------------------------------------|-----------------------------|-------------------------------------------------------------------------------------|
| StoreFront URL                                     | https://yj-en2016-1.ddc.com |                                                                                     |
| Storefront Status                                  |                             |                                                                                     |
| Receiver for Web Path                              | /Citrix/StoreWeb            |                                                                                     |
| Default Active Directory Domain                    | ddc.com                     |                                                                                     |
| List of Secure Ticket Authority URL(s) with status |                             |                                                                                     |
| http://[redacted].com                              | ● DOWN                      |                                                                                     |
| http://[redacted].com                              | ● DOWN                      |                                                                                     |
| http://[redacted].com                              | ● DOWN                      |                                                                                     |
| http://[redacted].com                              | ● DOWN                      |                                                                                     |

4. Add the **Secure Ticket Authority URL**.

- If the Secure XML feature is enabled, then the STA URL must be the URL of the load balancing service.
- If the Secure XML feature is disabled, then the STA URL must be the URL of STA (DDC's address) and the TrustRequestsSentToTheXmlServicePort parameter on the DDC must be set to True.

### StoreFront

StoreFront URL\*

 ⓘ

**Retrieve Stores**

Receiver for Web Path\*

Default Active Directory Domain\*

Secure Ticket Authority URL\*

|                                                    |   |
|----------------------------------------------------|---|
| <input type="text" value="http://[redacted].com"/> | × |
| <input type="text" value="http://[redacted].com"/> | × |
| <input type="text" value="http://[redacted].com"/> | × |
| <input type="text" value="http://[redacted].com"/> | × |

+

**Test STA Connectivity**

Use this StoreFront for Authentication

## Sessions

June 29, 2023

Maintaining session activity is critical to providing the best user experience. Losing connectivity due

to unreliable networks, highly variable network latency, and range limitations of wireless devices can lead to user frustration. Moving quickly between devices and accessing the same applications at each logon is a priority for many mobile workers such as healthcare workers.

The features described in this article optimize the reliability of sessions, reduce inconvenience, downtime, and loss of productivity; using these features, mobile users can roam quickly and easily between devices.

You can also log a user off a session, disconnect a session, and configure session prelaunch and linger; see [Manage delivery groups](#).

## Session reliability

Session Reliability keeps sessions active and on the user's screen when network connectivity is interrupted. Users continue to see the application they are using until network connectivity resumes.

This feature is especially useful for mobile users with wireless connections. For example, a user with a wireless connection enters a railroad tunnel and momentarily loses connectivity. Ordinarily, the session is disconnected and disappears from the user's screen, and the user has to reconnect to the disconnected session. With Session Reliability, the session remains active on the machine. To indicate lost connectivity, the user's display freezes and the cursor changes to a spinning hourglass until connectivity resumes on the other side of the tunnel. The user continues to access the display during the interruption and can resume interacting with the application when the network connection is restored. Session Reliability reconnects users without reauthentication prompts.

Citrix Workspace app users cannot override the Controller setting.

You can use Session Reliability with Transport Layer Security (TLS). TLS encrypts only the data sent between the user device and Citrix Gateway.

Enable and configure Session Reliability with the following policy settings:

- The Session reliability connections policy setting allows or prevents session reliability.
- The Session reliability timeout policy setting has a default of 180 seconds, or three minutes. Although you can extend the amount of time session reliability keeps a session open, this feature is designed for user convenience. Therefore, it does not prompt the user for reauthentication. As you extend the amount of time a session is kept open, the chances increase that a user might get distracted and walk away from the user device. Those actions can potentially leave the session accessible to unauthorized users.
- Incoming session reliability connections use port 2598, unless you change the port number in the Session reliability port number policy setting.
- To prevent users from reconnecting to interrupted sessions without having to reauthenticate, use the Auto Client Reconnect feature. You can configure the Auto Client Reconnect authenti-

ation policy setting to prompt users to reauthenticate when reconnecting to interrupted sessions.

If you use both Session Reliability and Auto Client Reconnect, the two features work in sequence. Session Reliability closes, or disconnects, the user session after the amount of time you specify in the Session reliability timeout policy setting. After that, the Auto Client Reconnect policy settings take effect, attempting to reconnect the user to the disconnected session.

## Auto Client Reconnect

With the Auto Client Reconnect feature, Citrix Workspace app can detect unintended disconnections of ICA sessions and reconnect users to the affected sessions automatically. When this feature is enabled on the server, users do not have to reconnect manually to continue working.

For application sessions, Citrix Workspace app attempts to reconnect to the session until there is a successful reconnection or the user cancels the reconnection attempts.

For desktop sessions, Citrix Workspace app attempts to reconnect to the session for a specified period, unless there is a successful reconnection or the user cancels the reconnection attempts. By default, this period is five minutes. To change this period, edit the following registry setting on the user device (where `seconds` is the number of seconds after which no more attempts are made to reconnect the session).

```
HKLM\Software\Citrix\ICA Client\TransportReconnectRetryMaxTimeSeconds
; DWORD;<seconds>
```

Enable and configure Auto Client Reconnect with the following policy settings:

- **Auto Client Reconnect:** Enables or disables automatic reconnection by Citrix Workspace app after a connection has been interrupted.
- **Auto Client Reconnect authentication:** Enables or disables the requirement for user authentication after automatic reconnection.
- **Auto Client Reconnect logging:** Enables or disables logging of reconnection events in the event log. Logging is disabled by default. When enabled, the server's system log captures information about successful and failed automatic reconnection events. Each server stores information about reconnection events in its own system log. The site does not provide a combined log of reconnection events for all servers.

### Note:

Auto Client Reconnect without reauthentication is supported only for password authentication. If you use Federated Authentication Service or smart card authentication, Auto Client Reconnect without reauthentication is not supported. In such cases, users are redirected to the login screen.

Auto Client Reconnect incorporates an authentication mechanism based on encrypted user credentials. When a user initially logs on, the server encrypts and stores the user credentials in memory. The server also creates and sends a cookie containing the encryption key to Citrix Workspace app. Citrix Workspace app submits the key to the server for reconnection. The server decrypts the credentials and submits them to Windows logon for authentication. When cookies expire, users must reauthenticate to reconnect to sessions.

Cookies are not used if you enable the Auto Client Reconnect authentication setting. Instead, users are presented with a dialog box to users requesting credentials when Citrix Workspace app attempts to reconnect automatically.

For maximum protection of user credentials and sessions, use encryption for all communication between clients and the site.

Disable Auto Client Reconnect on Citrix Workspace app for Windows by using the `icaclient.adm` file. For more information, see the documentation for your Citrix Workspace app for Windows version.

Settings for connections also affect Auto Client Reconnect:

- By default, Auto Client Reconnect is enabled through policy settings at the site level, as described earlier. User reauthentication is not required. However, if a server's ICA TCP connection is configured to reset sessions with a broken communication link, automatic reconnection does not occur. Auto Client Reconnect works only if the server disconnects sessions when there is a broken or timed out connection. In this context, the ICA TCP connection refers to a server's virtual port (rather than an actual network connection) that is used for sessions on TCP/IP networks.
- By default, the ICA TCP connection on a server is set to disconnect sessions with broken or timed out connections. Disconnected sessions remain intact in system memory and are available for reconnection by Citrix Workspace app.
- The connection can be configured to reset or log off sessions with broken or timed-out connections. When a session is reset, attempting to reconnect initiates a new session. Rather than restoring a user to the same place in the application in use, the application is restarted.
- If the server is configured to reset sessions, Auto Client Reconnect creates a new session. This process requires users to enter their credentials to log on to the server.
- Automatic reconnection can fail if Citrix Workspace app or the plug-in submits incorrect authentication information, which might occur during an attack or the server determines that too much time has elapsed since it detected the broken connection.

## **ICA Keep-Alive**

Enabling the ICA Keep-Alive feature prevents broken connections from being disconnected. When enabled, if the server detects no activity, this feature prevents Remote Desktop Services from disconnecting that session. Examples of no activity include no clock change, no mouse movement, no screen

updates. The server sends keep-alive packets every few seconds to detect if the session is active. If the session is no longer active, the server marks the session as disconnected.

**Important:**

ICA Keep-Alive works only if you are not using Session Reliability. Session Reliability has its own mechanisms to prevent broken connections from being disconnected. Configure ICA Keep-Alive only for connections that do not use Session Reliability.

ICA Keep-Alive settings override keep-alive settings that are configured in Windows Group Policy.

Enable and configure ICA Keep-Alive with the following policy settings:

- **ICA keep alive timeout:** Specifies the interval (1-3600 seconds) used to send ICA keep-alive messages. Do not configure this option if you want your network monitoring software to close inactive connections in environments where broken connections are so infrequent that allowing users to reconnect to sessions is not a concern.

The default interval is 60 seconds: ICA Keep-Alive packets are sent to user devices every 60 seconds. If a user device does not respond in 60 seconds, the status of the ICA sessions changes to disconnected.

- **ICA keep alives:** Sends or prevents sending ICA keep-alive messages.

## Workspace control

Workspace control lets desktops and applications follow a user from one device to another. This ability to roam enables a user to access all desktops or open applications from anywhere simply by logging on, without having to restart the desktops or applications on each device. For example, workspace control can assist healthcare workers in a hospital who need to move quickly among different workstations and access the same set of applications each time they log on. If you configure workspace control options to allow it, these workers can disconnect from multiple applications at one client device and then reconnect to open the same applications at a different client device.

Workspace control affects the following activities:

- **Logging on:** By default, workspace control enables users to reconnect automatically to all running desktops and applications when logging on, bypassing the need to reopen them manually. Through workspace control, users can open disconnected desktops or applications, plus any that are active on another client device. Disconnecting from a desktop or application leaves it running on the server. If you have roaming users who must keep some desktops or applications running on one client device while they reconnect to a subset of their desktops or applications on another client device, you can configure the logon reconnection behavior to open only the desktops or applications that the user disconnected from previously.



- **Reconnecting:** After logging on to the server, users can reconnect to all of their desktops or applications at any time by clicking Reconnect. By default, Reconnect opens desktops or applications that are disconnected, plus any that are currently running on another client device. You can configure Reconnect to open only those desktops or applications that the user disconnected from previously.
- **Logging off:** For users opening desktops or applications through StoreFront, you can configure the **Log Off** command to log the user off from StoreFront and all active sessions, or from StoreFront only.
- **Disconnecting:** Users can disconnect from all running desktops and applications at once, without needing to disconnect from each individually.

Workspace control is available only for Citrix Workspace app users who access desktops and applications through a Citrix StoreFront connection. By default, workspace control is disabled for virtual desktop sessions, but is enabled for hosted applications. Session sharing does not occur by default between published desktops and any published applications running inside those desktops.

User policies, client drive mappings, and printer configurations change appropriately when a user moves to a new client device. Policies and mappings are applied according to the client device where the user is logged on to the session. For example, a healthcare worker logs off from a device in the emergency room and then logs on to a workstation in the x-ray laboratory. The policies, printer mappings, and client drive mappings appropriate for the session in the x-ray laboratory go into effect at the session startup.

You can customize which printers appear to users when they change locations. You can also control whether users can print to local printers, how much bandwidth is consumed when users connect remotely, and other aspects of their printing experiences.

For information about enabling and configuring workspace control for users, see the StoreFront documentation.

## Session roaming

### Note:

The following information guides you to configure session roaming using PowerShell. You can use Web Studio instead. For more information, see [Manage delivery groups](#).

By default, sessions roam between client devices with the user. When the user launches a session and then moves to another device, the same session is used and applications are available on both devices. The applications follow, regardless of the device or whether current sessions exist. Often, printers and other resources assigned to the application also follow.

While this default behavior offers many advantages, it might not be ideal in all cases. You can prevent session roaming using the PowerShell SDK.

Example 1: A medical professional is using two devices, completing an insurance form on a desktop PC, and looking at patient information on a tablet.

- If session roaming is enabled, both applications appear on both devices (an application launched on one device is visible on all devices in use). This might not meet security requirements.
- If session roaming is disabled, the patient record does not appear on the desktop PC, and the insurance form does not appear on the tablet.

Example 2: A production manager launches an application on the PC in his office. The device name and location determine which printers and other resources are available for that session. Later in the day, he goes to an office in the next building for a meeting that will require use of a printer.

- When session roaming is enabled, the production manager would probably be unable to access the printers near the meeting room, because the applications he launched earlier in his office resulted in the assignment of printers and other resources near that location.
- When session roaming is disabled, when he logs on to a different machine (using the same credentials), a new session is started, and nearby printers and resources will be available.

### Configure session roaming

To configure session roaming, use the following entitlement policy rule cmdlets with the “SessionReconnection” property. Optionally, you can also specify the “LeasingBehavior” property.

For desktop sessions:

```
Set-BrokerEntitlementPolicyRule <Delivery-Group-name> -SessionReconnection
<value> -LeasingBehavior Allowed|Disallowed
```

For application sessions:

```
Set-BrokerAppEntitlementPolicyRule <Delivery-Group-name> -SessionReconnection
<value> -LeasingBehavior Allowed|Disallowed
```

Where `value` can be one of the following:

- **Always:** Sessions always roam, regardless of the client device and whether the session is connected or disconnected. This is the default value.
- **DisconnectedOnly:** Reconnect only to sessions that are already disconnected; otherwise, launch a new session. (Sessions can roam between client devices by first disconnecting them, or using Workspace Control to explicitly roam them.) An active connected session from another client device is never used. Instead, a new session is launched.
- **SameEndpointOnly:** A user gets a unique session for each client device they use. This completely disables roaming. Users can reconnect only to the same device that was previously used in the session.

The “LeasingBehavior” property is described below.

**Effects from other setting:**

Disabling session roaming is affected by the application limit **Allow only one instance of the application per user** in the application’s properties in the delivery group.

- If you disable session roaming, then disable the “Allow only one instance ...” application limit.
- If you enable the “Allow only one instance ...” application limit, do not configure either of the two values that allow new sessions on new devices.

**Logon interval**

If a virtual machine containing a desktop VDA closes before the logon process completes, you can allocate more time to the process. The default for 7.6 and later versions is 180 seconds (the default for 7.0-7.5 is 90 seconds).

On the machine (or the master image used in a machine catalog), set the following registry key:

Key: `HKLM\SOFTWARE\Citrix\PortICA`

- Value: `AutoLogonTimeout`
- Type: `DWORD`
- Specify a decimal time in seconds, in the range 0-3600.

If you change a master image, update the catalog.

This setting applies only to VMs with desktop VDAs. Microsoft controls the logon timeout on machines with server VDAs.

**Tags**

November 2, 2023

**Note:**

You can manage your Citrix Virtual Apps and Desktops deployment using two management consoles: Web Studio (web-based) and Citrix Studio (Windows-based). This article covers only Web Studio. For information about Citrix Studio, see the equivalent article in Citrix Virtual Apps and Desktops 7 2212 or earlier.

## Introduction

Tags are strings that identify items such as machines, applications, desktops, delivery groups, application groups, and policies. After creating a tag and adding it to an item, you can tailor certain operations to apply to only items that have a specified tag.

- Tailor search displays in Web Studio.

For example, to display only applications that have been optimized for testers, create a tag named “test” and then add (apply) it to those applications. You can now filter the Web Studio search with the tag “test”.

- Publish applications from an application group or specific desktops from a delivery group, considering only a subset of the machines in selected delivery groups. This is called a *tag restriction*.

With tag restrictions, you can use your existing machines for more than one publishing task, saving the costs associated with deploying and managing more machines. A tag restriction can be thought of as subdividing (or partitioning) the machines in a delivery group. Its functionality is similar, but not identical, to worker groups in XenApp releases earlier than 7.x.

Using an application group or desktops with a tag restriction or can be helpful when isolating and troubleshooting a subset of machines in a delivery group.

- Schedule periodic restarts for a subset of machines in a delivery group.

Using a tag restriction for machines enables you to use new PowerShell cmdlets to configure multiple restart schedules for subsets of machines in a delivery group. For examples and details, see [Manage delivery groups](#).

- Tailor the application (assignment) of Citrix policies to a subset of machines in delivery groups, delivery group types, or OUs that have (or do not have) a specified tag.

For example, if you want to apply a Citrix policy only to the more powerful workstations, add a tag named “high power” to those machines. Then, on the **Assign Policy** page of the Create Policy wizard, select that tag and the **Enable** check box. You can also add a tag to a delivery group and then apply a Citrix policy to that group. For details, see [Create policies](#).

You can apply tags to:

- Machines
- Applications
- Machine catalogs (PowerShell only; see Tags on machine catalogs)
- Delivery groups
- Application groups

You can configure a tag restriction can be configured when creating or editing the following in Web Studio:

- A desktop in a shared delivery group
- An application group

## Tag restrictions for a desktop or an application group

A tag restriction involves several steps:

- Create the tag and then add (apply) it to machines.
- Create or edit a group with the tag restriction (in other words, “restrict launches to machines with tag x”).

A tag restriction extends the broker’s machine selection process. The broker selects a machine from an associated delivery group subject to access policy, configured user lists, zone preference, and launch readiness, plus the tag restriction (if present). For applications, the broker falls back to other delivery groups in priority order, applying the same machine selection rules for each considered delivery group.

### Example 1: Simple layout

This example introduces a simple layout that uses tag restrictions to limit which machines are considered for certain desktop and application launches. The site has one shared delivery group, one published desktop, and one application group configured with two applications.

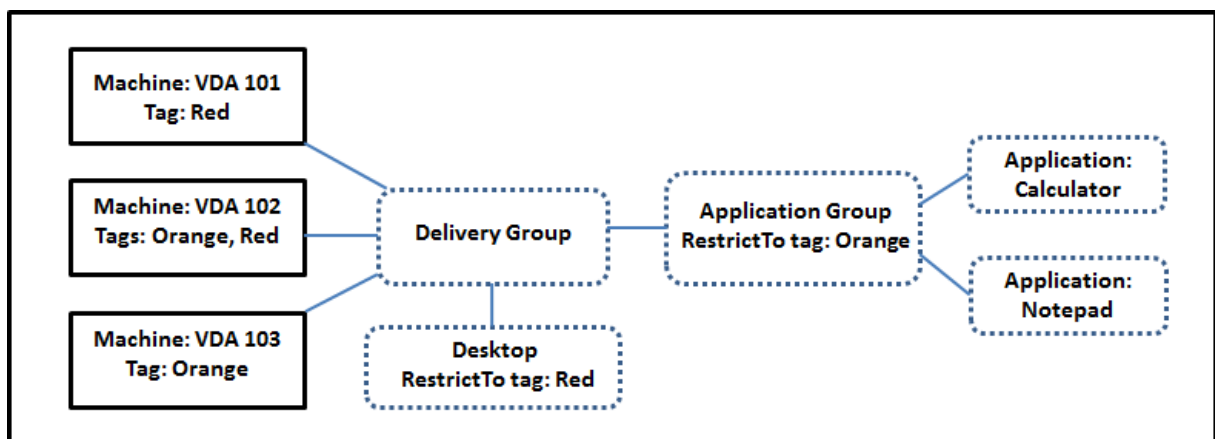

- Tags have been added to each of the three machines (VDA 101–103).
- The desktop in the shared delivery group was created with a tag restriction named “Red”. A desktop can be launched only on machines in that delivery group that have the tag “Red”: VDA 101 and 102.
- The application group was created with the “Orange” tag restriction, so each of its applications (Calculator and Notepad) can be launched only on machines in that delivery group that have the tag “Orange”: VDA 102 and 103.

Machine VDA 102 has both tags (Red and Orange), so it can be considered for launching the applications and the desktop.

### Example 2: More complex layout

This example contains several application groups that were created with tag restrictions. This results in the ability to deliver more applications with fewer machines than would otherwise be needed if you used only delivery groups.

How to configure example 2 shows the steps used to create and apply the tags, and then configure the tag restrictions in this example.

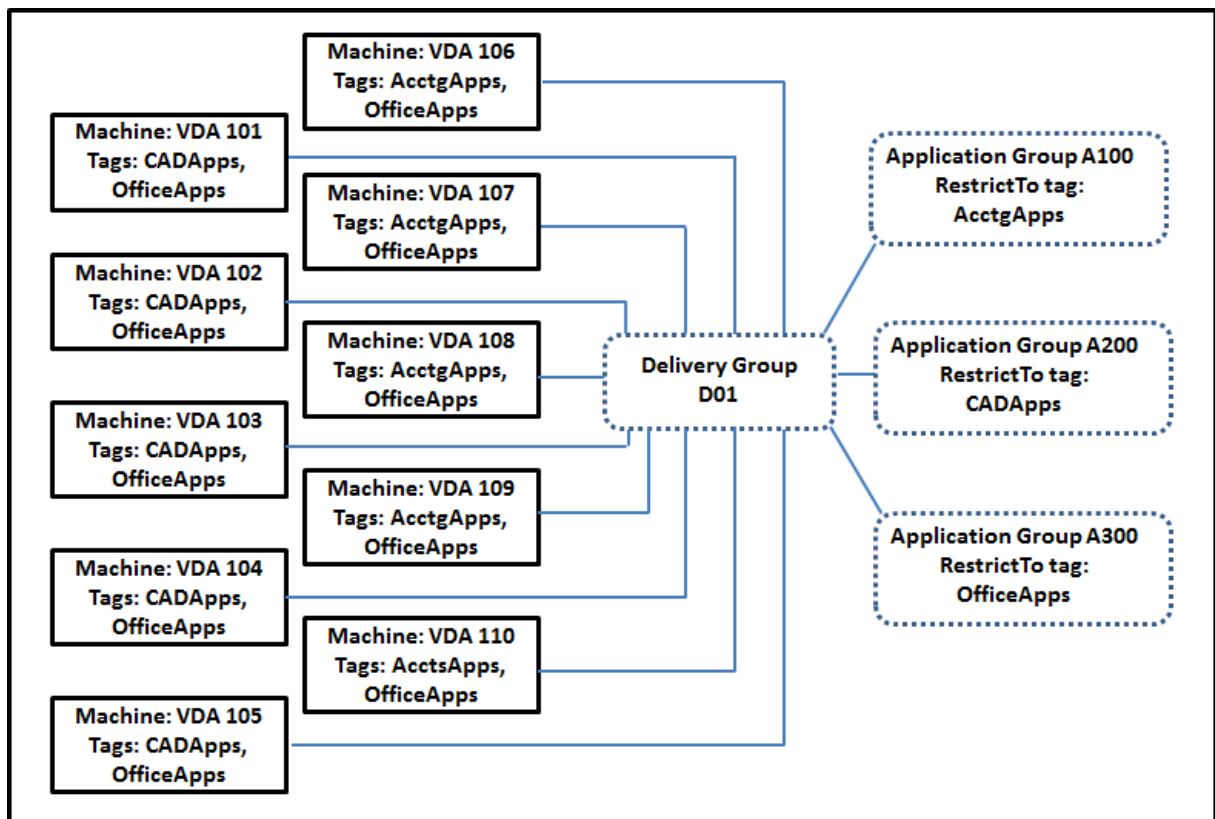

This example uses 10 machines (VDA 101–110), one delivery group (D01), and three application groups (A100, A200, A300). By applying tags to each machine and then specifying tag restrictions when creating each application group:

- Accounting users in the group can access the apps they need on five machines (VDA 101–105)
- CAD designers in the group can access the apps they need on five machines (VDA 106-110)
- Users in the group who need Office applications can access the Office apps on 10 machines (VDA 101–110)

Only 10 machines are used, with only one delivery group. Using delivery groups alone (without application groups) would require twice as many machines, because a machine can belong to only one

delivery group.

## Manage tags and tag restrictions

Tags are created, added (applied), edited, and deleted from selected items through the **Manage Tags** action in Web Studio.

(Exception: Tags used for policy assignments are created, edited, and deleted through the **Manage Tags** action in Web Studio. However, tags are applied (assigned) when you create the policy. See [Create policies](#) for details.)

Tag restrictions are configured when you create or edit desktops in delivery groups, and when you create and edit application groups.

## Use the Manage Tags dialogs in Web Studio

In Web Studio, select the items you want to apply a tag to (one or more machines, applications, a desktop, a delivery group, or an application group) and then select **Manage Tags** in the action bar. The dialog box lists all the tags that have been created in the Site, not just for the items you selected.

- A check box containing a check mark indicates that the tag has already been added to the selected items. (In the screen capture below, the selected machine has the tag named “Tag1” applied.)
- If you selected more than one item, a check box containing a hyphen indicates that some, but not all selected items have that tag added.

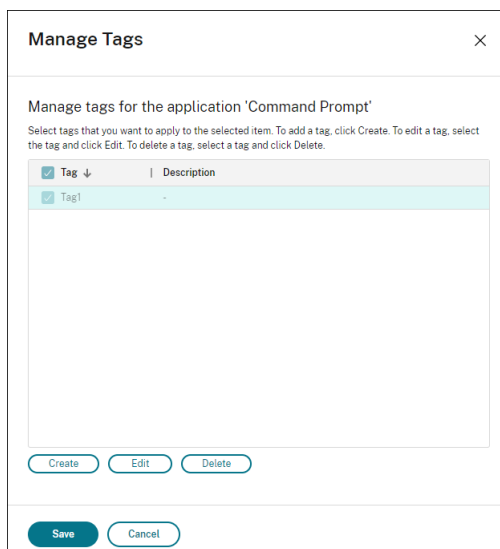

The following actions are available from the **Manage Tags** dialog box. Be sure to review Cautions when working with tags.

- **To create a tag:**

Click **Create**. Enter a name and description. Tag names must be unique and are not case-sensitive. Then click **OK**. (Creating a tag does not automatically apply it to any items you have selected. Use the check boxes to apply the tag.)

- **To add (apply) one or more tags:**

Enable the check box next to the tag name. If you selected multiple items and the check box next to a tag contains a hyphen (indicating that some, but not all selected items already have the tag applied), changing it to a check mark affects all selected machines.

If you attempt to add a tag to one or more machines, and that tag is being used as a restriction in an application group, you are warned that the action can result in making those machines available for launch. If that's what you intended, proceed.

- **To remove one or more tags:**

Clear the check box next to the tag name. If you selected multiple items and the check box next to a tag contains a hyphen (indicating that some, but not all selected items already have the tag applied), clearing the check box removes the tag from all selected machines.

If you attempt to remove a tag from a machine that is using that tag as a restriction, you are warned that the action can affect which machines are considered for launch. If that's what you intended, proceed.

- **To edit a tag:**

Select a tag and then click **Edit**. Enter a new name, description, or both. You can edit only one tag at a time.

- **To delete one or more tags:**

Select the tags and then click **Delete**. The Delete Tag dialog box indicates how many items currently use the selected tags (for example "2 machines"). Click an item to display more information. For example, clicking a "2 machines" item displays the names of the two machines that have that tag applied. Confirm whether you want to delete the tags.

You cannot use Web Studio to delete a tag that is used as a restriction. First, edit the application group and remove the tag restriction or select a different tag.

When you're done in the **Manage Tags** dialog box, click **Save**.

To see if a machine has any tags applied: Select **Delivery Groups** in the left pane. Select a delivery group in the middle pane and then select **View Machines** in the action bar. Select a machine in the middle pane and then select the **Tags** tab on the **Details** pane.



## Manage tag restrictions

Configuring a tag restriction is a multi-step process: You first create the tag and add/apply it to machines. Then, you add the restriction to the application group or the desktop.

- **Create and apply the tag:**

Create the tag and then add (apply) it to the machines affected by the tag restriction, using the **Manage Tags** actions described earlier.

- **To add a tag restriction to an application group:**

Create or edit the application group. On the **Delivery Groups** page, select **Restrict launches to machines with the tag** and then select the tag from the list.

- **To change or remove the tag restriction on an application group:**

Edit the group. On the **Delivery Groups** page, either select a different tag from the list or remove the tag restriction entirely by clearing **Restrict launches to machines with the tag**.

- **To add a tag restriction to a desktop:**

Create or edit a delivery group. Click **Add** or **Edit** on the **Desktops** page. In the Add Desktop dialog box, select **Restrict launches to machines with the tag** and then select the tag from the menu.

- **To change or remove the tag restriction on a delivery group:**

Edit the group. On the Desktops page, click **Edit**. In the dialog box, either select a different tag from the lists or remove the tag restriction entirely by clearing **Restrict launches to machines with the tag**.

## Cautions when working with tags

A tag applied to an item can be used for different purposes, so keep in mind that adding, removing, and deleting a tag can have unintended effects. You can use a tag to sort machine displays in the Web Studio search field. You can use the same tag as a restriction when configuring an application group or a desktop. The tag limits launch consideration to only machines in specified delivery groups that have that tag.

When you try to add a tag to machines after that tag has been configured as a tag restriction for a desktop or an application group, a warning appears. Adding that tag might make the machines available for launching additional applications or desktops. If that is what you intended, proceed. If not, you can cancel the operation.

For example, let's say you create an application group with the "Red" tag restriction. Later, you add several other machines in the same delivery groups used by that application group. If you then attempt to add the "Red" tag to those machines, Web Studio displays a message similar to: "The tag

“Red” is used as a restriction on the following application groups. Adding this tag might make the selected machines available to launch applications in this application group.” You can then confirm or cancel adding that tag to those additional machines.

Similarly, if an application group uses a tag to restrict launches, Web Studio warns that you cannot delete the tag until you edit the group to remove it as a restriction. (If you were allowed to delete a tag that’s used as a restriction in an application group, that might result in allowing applications to launch on all machines in the delivery groups associated with the application group.) The same prohibition against deleting a tag applies if the tag is being used as a restriction for desktop launches. After you edit the application group or desktops in the delivery group to remove that tag restriction, you can delete the tag.

All machines might not have the same sets of applications. A user can belong to more than one application group, each with a different tag restriction and different or overlapping sets of machines from delivery groups. The following table lists how machine considerations are decided.

---

| <b>When an application has been added to</b>                                             | <b>These machines in the selected delivery groups are considered for launch</b>                    |
|------------------------------------------------------------------------------------------|----------------------------------------------------------------------------------------------------|
| One application group with no tag restriction                                            | Any machine.                                                                                       |
| One application group with tag restriction A                                             | Machines that have tag A applied.                                                                  |
| Two application groups, one with tag restriction A and the other with tag restriction B  | Machines that have tag A and tag B. If none are available, then machines that have tag A or tag B. |
| Two application groups, one with tag restriction A and the other with no tag restriction | Machines that have tag A. If none are available, then any machine.                                 |

---

If you used a tag restriction in a machine restart schedule, any changes you make that affect tag applications or restrictions affect the next machine restart cycle. It does not affect any restart cycles that are in progress while the changes are being made.

### **How to configure example 2**

The following sequence shows the steps to create and apply tags, and then configure tag restrictions for the application groups illustrated in the second example.

VDAs and applications have already been installed on the machines and the delivery group has been created.

Create and apply tags to the machines:

1. In Web Studio, select delivery group D01 and then select **View Machines** in the action bar.
2. Select machines VDA 101–105 and then select **Manage Tags** in the action bar.

3. In the Manage Tags dialog box, click **Create** and then create a tag named `CADApps`. Click **OK**.
4. Click **Create** again and create a tag named `OfficeApps`. Click **OK**.
5. While still in the **Manage Tags** dialog box, add (apply) the newly created tags to the selected machines by enabling the check boxes next to each tag's name (`CADApps` and `OfficeApps`). When you're done, close the dialog box.
6. Select delivery group D01, select **View Machines** in the action bar.
7. Select machines VDA 106–110 and then select **Manage Tags** in the action bar.
8. In the **Manage Tags** dialog box, click **Create**. Create a tag named `AcctgApps`. Click **OK**.
9. Apply the newly created `AcctgApps` tag and the `OfficeApps` tag to the selected machines by clicking the check boxes next to each tag's name, and then close the dialog box.

Create the application groups with tag restrictions.

1. In Web Studio, select **Applications** in the left pane, select the **Application Groups** tab, and then select **Create Application Group** in the action bar. The Create Application Group wizard launches.
2. On the **Delivery Groups** page of the wizard, select delivery group D01. Select **Restrict launches to machines with tag** and then select the `AcctgApps` tag from the list.
3. Complete the wizard, specifying the accounting users and the accounting applications. (When adding the application, choose the **From Start menu** source, which searches for the application on the machines that have the `AcctgApps` tag.) On the **Summary** page, name the group `A100`.
4. Repeat the preceding steps to create application group `A200`, specifying machines that have the `CADApps` tag, plus the appropriate users and applications.
5. Repeat steps to create application group `A300`, specifying machines that have the `OfficeApps` tag, plus the appropriate users and applications.

### Tags on machine catalogs

You can use tags on machine catalogs. The overall sequence of creating a tag and then applying it to a catalog is the same as described previously. However, applying tags to catalogs is supported only through the PowerShell interface. You cannot use Web Studio to apply a tag to a catalog or remove a tag from a catalog. Catalog displays in Web Studio do not indicate if a tag is applied.

Summary: You can use Web Studio or PowerShell to create or delete a tag for use on a catalog. Use PowerShell to apply the tag to the catalog.

Here are some examples of using tags with catalogs:

- A delivery group has machines from several catalogs, but you want an operation (such as a restart schedule) to affect only the machines in a specific catalog. Applying a tag to that catalog accomplishes that.

- In an application group, you want to limit application sessions to machines in a specific catalog. Applying a tag to that catalog accomplishes that.

Affected PowerShell cmdlets:

- You can pass catalog objects to cmdlets such as [Add-BrokerTag](#) and [Remove-BrokerTag](#).
- [Get-BrokerTagUsage](#) shows how many catalogs contain tags.
- [Get-BrokerCatalog](#) has a property named `Tags`.

For example, the following cmdlets add a tag named `fy2018` to the catalog named `acctg`:

```
Get-BrokerCatalog -Name acctg | Add-BrokerTag fy2018.
```

(The tag was previously created using either Web Studio or PowerShell.)

See the PowerShell cmdlet help for more guidance and syntax.

## Auto tags (Preview)

Auto-tagging allows administrators to set and remove tags on various Citrix Virtual Apps and Desktops objects automatically, based on custom rules. This enhancement eliminates the need to maintain different scripts that run periodically for environment optimization.

### Use cases

With auto-tagging, you can implement rules relevant to your business drivers, such as reducing costs, optimizing the infrastructure, and driving consumption. The following are some of the use cases:

- **Reclaim unused VDIs** - To release the dedicated workloads that have not been used for more than a pre-configured number of days to the available pool.
- **Remove App clutter** - To reduce application clutter by identifying the applications that have not been used for more than a pre-configured number of days.
- **DGs with less than X functional level** - To find delivery groups with less than a specific functional level.
- **Inactive users** - To reclaim resources of users who have not logged on for more than a pre-configured number of days.

### PowerShell commands

You can create autotags using PowerShell commands. After an autotag rule is created, it is evaluated at a frequency of 600 seconds. For more information, see [New-BrokerAutoTagRule](#).

**Examples** `New-BrokerAutoTagRule` uses the same object type and filter parameters as the `Get-BrokerMachine` commandlet. For more information, see [GetBrokerMachine](#).

1. Tag dedicated VDIs that have not been used for more than 30 days with and ID 123:

a) Define a tag to tag the unused VDIs with, say **unused-VDI**.

- Tag name : unused-VDI
- Tag ID : 123

b) Create the auto-tagging rule to tag unused machines. Define the rule parameters:

- Name : Generic name for the rule.
- Object type : Machine.
- Rule text : Static, assigned machines whose last connection time is > 30 days or no value.
- Tag Uid : The tag id that you want to associate with, 123.

```
New-BrokerAutoTagRule -Name 'UnusedVdi' -ObjectType 'Machine'
-RuleText "-AllocationType Static -IsAssigned $true -Filter
{ SummaryState -ne `”InUse`” -and (LastConnectionTime -lt
`-30` -or LastConnectionTime -eq `$null)} ” -TagUid 123<!--
NeedCopy-->
```

c) Check machines marked with the tag **unused-VDI** and release them.

2. To tag delivery groups with less than X functional level (using **L7\_20** as the threshold functional level):

```
New-BrokerAutoTagRule -Name 'LowFL'-ObjectType 'DesktopGroup'-RuleText
"-Filter { MinimumFunctionalLevel -lt 'L7_20' } "-TagUid 123
```

1. To tag user visible apps published without a folder:

```
New-BrokerAutoTagRule -Name 'NoFolder'-ObjectType 'Application'-
RuleText "-Enabled $true -Filter { ClientFolder -eq $null)} "-TagUid
123
```

## More information

Blog post: [How to assign desktops to specific servers.](#)

## Use Search in Studio

October 30, 2023

### Note:

You can manage your Citrix Virtual Apps and Desktops deployment using two management consoles: Web Studio (web-based) and Citrix Studio (Windows-based). This article covers only Web Studio. For information about Citrix Studio, see the equivalent article in Citrix Virtual Apps and Desktops 7 2212 or earlier.

Use the search feature to view information about specific machines, sessions, machine catalogs, applications, or delivery groups. After selecting **Search** in Web Studio, you have several options:

- Use tabs to list machines by type (single-session or multi-session OS), or list all sessions.
- Enter the name in the search box. As you type, filters are provided for a quick search.
- Refine the search using filters.
  - By default, the following filters are pinned in the view: **Name**, **Session State**, and **Fault State**. Select a filter to build an expression. To customize your filters, click the ellipsis. In the window that appears, you can do the following:
    - \* Pin or unpin filters. Unpinned filters are for one-time use and are not saved.
    - \* Click a filter to add it to the view.
    - \* Clear filters to clear the current filtered search and to remove unpinned filters.
  - Click the operator to toggle between **Match all (AND operator)** or **Match any (OR operator)**. When set to **Match all**, the search returns results that match all filter criteria. When set to **Match any**, the search returns results that match any of the filter criteria.
  - Save your filters in use by clicking the star symbol. The item saved is known as a filter set. Saved items appear in the Saved filter sets list. (To access the list, select the search box.) You can click a saved filter set to apply the filters against your search. To manage saved filter sets, select the search box and then select **Manage**.

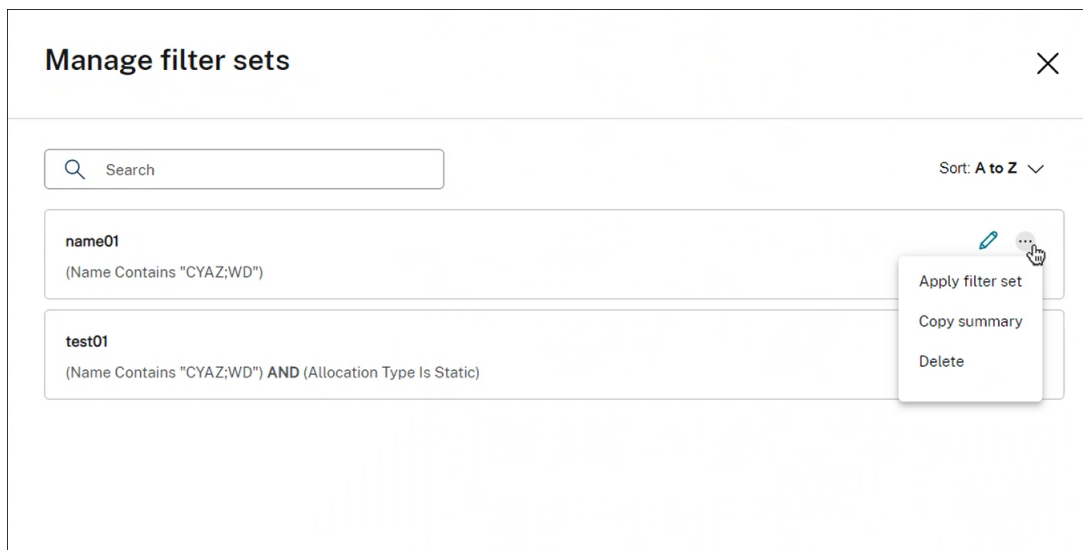

## Search without filters

As you type in a search box, a menu with prompts appears, providing different search options to help you quickly refine your search. Suppose the content that you typed is *VM01*. Select one of the following prompts:

- **VM01 Name.** Searches by name.
- **VM01 Machine Catalog.** Searches by name.
- **VM01 Delivery Group.** Searches by delivery group name.

By performing a general search, Citrix Virtual Apps and Desktops searches for matches across the following criteria and provides relevant results:

- **Name.** Searches by machine name or DNS name.
- **Machine Catalog.** Searches by machine catalog name.
- **Delivery Group.** Searches by delivery group name.
- **User.** Searches by session user name.
- **Client.** Searches by session client name.
- **VM.** Searches by hosted machine name. It's the friendly name of the hosted machine used by its hypervisor.
- **Hosting Server Name.** Searches by hosting server name.

When you search for a particular item, such as user, desktop group, catalog, or machine, the general search provides a convenient way to find the information you need.

## Search for machine catalogs or delivery groups

You can search and locate resources within the Machine Catalog and Delivery Group nodes. The search functionality in these nodes provides the same interface as the Search node, providing a seamless search experience across Citrix Virtual Apps and Desktops.

You can perform general searches and filter-based searches. In Machine Catalog, the following filters are available:

- **Catalog Name.** Searches by the name of the machine catalog.
- **Allocation Type.** Filters by static (dedicated) or random (pooled) allocation, or both.
- **Provisioning Type.** Filters by manual or MCS provisioning method, or both.
- **Session Support.** Filters by single-session or multi-session machine, or both.
- **Allocated Count.** Filters by the number of allocated machines.
- **Persistence.** Filters by non-persistent (discard) or persistent (on local disk) machine changes, or both.
- **Machine Type.** Filters by physical or virtual machine type, or both.

In Delivery Groups, the following filters are available:

- **Group Name.** Searches by the name of the delivery group.
- **Description.** Filters by delivery group description specified during delivery group creation.
- **Session Support.** Filters by single-session or multi-session machine, or both.
- **Machine Identity.** Filters by the identity of the machine.
- **Remote PC Access.** Filters by Remote PC Access machine.
- **Maintenance mode.** Filters by machines in maintenance mode (on, or off, or both).
- **Group State.** Filters by the state of the group. (The Enable delivery group option in Edit Delivery Group > User Settings controls whether to stop the delivery of applications and desktops.)
- **Allocation Type.** Filters by static (dedicated) or random (pooled) type, or both.

By performing a general search, Citrix Virtual Apps and Desktops searches for items across the following criteria and provides relevant results:

- Machine Catalogs:
  - Name: Searches for machine catalogs by name, including folder path.
  - Machine catalog: Searches for machine catalogs by name.
  - Description. Searches by machine catalog description specified during catalog creation.
- Delivery Groups:
  - Delivery group name: Searches for delivery groups by name.
  - Description: Searches by delivery group description specified during delivery group creation.



## Search for Application Group

You can perform general searches and filter-based searches for application groups. In the application group, the following filters are available:

- **Name.** Filters by the name of the application group.
- **Tag.** Filters by the tag of the application group.
- **Description.** Filters by the application group description specified during the application group creation.
- **Delivery group.** Filters by the delivery group of the application group.
- **State.** Filters by the state of the application group.

## Customize columns to display

When customizing columns, you can see columns marked with the **Degrades performance** label. Selecting those columns might degrade the performance of the console. After you complete your customization, the table refreshes to display the columns you select. Their presence might result in delays when you refresh the table.

If your customization contains columns that degrade performance, you are prompted to determine whether to preserve them. The prompt appears after you refresh the browser window or sign out of the console and then sign in. Be aware of the following considerations if you decide to preserve the columns:

- To ensure console performance, you cannot refresh the table more than once a minute. This restriction applies to all tabs: **Single-session OS Machines**, **Multi-session OS Machines**, and **Sessions**. If you require more frequent refreshes, remove all columns that degrade performance.

## Export search results to a CSV file

You can export your search results (up to 10,000 items) to a CSV file. The file is saved to the default download location of your browser.

This feature is available for both machines and sessions. To export your search results, click the export icon in the upper right corner. The export might take up to 1 minute to complete.

On each tab of the Search node, you cannot perform another export while an export is in progress.

## Tips to enhance a search

Consider the following tips when using the Search feature:

- On the **Search** node, select any column to sort items.
- To show more characteristics to include in the display where you can search and sort, select **Columns to Display** or click any column and select **Columns to Display**. In the **Columns to Display** window, select the check box next to the items you want to display and select **Save** to exit.

**Note:**

Items that degrade performance are marked with the **Degrades performance** label.

- To locate a user device connected to a machine, use **Client (IP)** and **Is**, and enter the device IP address.
- To locate active sessions, use **Session State**, **Is**, and **Connected**.
- To list all machines in a delivery group, select **Delivery Groups** in the left pane. Select the group, and then select **View Machines** from the action bar or from the context menu.

Keep the following considerations in mind when performing sort operations:

- As long as the number of items does not exceed 5,000, you can click any column to sort the items in it. When the number exceeds 5,000, you can sort only by name or by current user (depending on which tab you are on). To enable sorting, use filters to reduce the number of items to 5,000 or fewer.
- When the number of items is greater than 500 but no more than 5,000:
  - We cache all data locally to improve sort performance. On the **Single-session OS Machines** and **Multi-session OS Machines** tabs, we cache the data the first time you click a column (any column except the **Name** column) to sort. On the **Sessions** tab, we cache the data the first time you click a column (any column except the **Current User** column) to sort. As a result, the sort takes longer to complete. For faster performance, sort by name or current user, or use filters to reduce the number of items.
  - The following message under the table indicates that the data is cached: Last refreshed: *<the time when you refreshed the table>*. In that case, sort operations are based on items that were loaded previously. Those items might not be up to date. To bring them up to date, click the refresh icon.

## Settings

March 13, 2024

**Note:**

You can manage your Citrix Virtual Apps and Desktops deployment using two management consoles: Web Studio (web-based) and Citrix Studio (Windows-based). This article covers only Web Studio. For information about Citrix Studio, see the equivalent article in Citrix Virtual Apps and Desktops 7 2212 or earlier.

You can use Web Studio to manage these settings:

- Manage Authentication
- [Citrix Customer Experience Improvement Program](#)
- [Remove Delivery Controllers](#)
- [Change the logging database](#)
- Set date and time
- Centralize site management
- [Enable automatic assignment of multiple users for Remote PC Access](#)
- Enable DNS resolution
- [Enable XML trust](#)
- [Manage security key](#)
- Set the inactivity timeout for the Studio console

## Manage authentication

By default, users authenticate to Web Studio using their domain credentials (user name and password). You can enable integrated Windows authentication so that users can access Studio with their Windows credentials, using Kerberos or NTLM. Disabling the sign-in with domain credentials is not supported.

**Important**

Integrated Windows authentication does not work when Web Studio is configured as a proxy for Delivery Controllers.

After you enable the **Integrated Windows authentication** option, the next time your users log on, they are automatically signed in. As a user if you are unable to sign in automatically, follow these steps to configure your web browser to allow integrated Windows authentication.

For Google Chrome:

1. From the Control Panel, select Internet Options.
2. Select the **Advanced** tab.
3. Select **Enable Integrated Windows Authentication**.
4. Select the **Security** tab.
5. Select **Local Intranet > Sites > Advanced**.
6. In the **Add this website to the zone** box:
  - If the Web Studio and the Delivery Controller reside on the same server, type the URL of the host running the Web Studio.
  - If not, type a wildcard domain. Example: if the Delivery Controller is at `ddc.domain.com`, type `*.domain.com`.
7. Click **Add > Close**

For Mozilla Firefox:

1. From the browser, type `about:config` in the URL box.
2. In the **Search** box, type `network negotiate`.
3. Right-click **network.negotiate-auth.trusted-uris** and select **Modify**.
4. In the **Enter string value** box:
  - If the Web Studio and the Delivery Controller reside on the same server, add a comma-separated list of URLs and/or aliases referencing the name of the server hosting the Web Studio.
  - If not, add the URLs this way. Example: if the Delivery Controller is at `ddc.domain.com`, type `*.domain.com`.

After you configure your browser, you can click **Windows integrated sign-in** on the sign-in page to try again.

When the Web Studio and the Delivery Controller are installed on different machines, for integrated Windows authentication to work, you need to enable **Allow cross-origin access**.

Follow these steps to enable **Allow cross-origin access**:

1. Select the **Allow cross-origin access** checkbox.
2. Add the URL of the Web Studio server to the allow list.
3. In the **Enter URL** field, enter the URL. Click **Add** to add more if necessary.

#### Note

- The URL must follow the correct format:<scheme>://<hostname>. Make sure that it does not include any paths or trailing slashes.
- IP addresses and FQDNS are supported. When adding a URL, ensure that it corresponds to how you access the Web Studio. For example, if accessing the Web Studio using an IP address, add the IP address-based URL to the list.
- If you use a non-default port, be sure to include the port number.

4. Click **Add** to add more if necessary.
5. After you have finished, click **Done** to save and exit.

## Set up the time zone

To customize the date and time format to suit your preferences, follow these steps:

1. Sign in to Web Studio and select **Settings** in the left pane.
2. Locate the **Date and time** tile and click **Edit** to configure the following options:
  - **Time format:**
    - Select to display the time using a 12-hour clock (09:00 pm, for example) or a 24-hour clock (21:00, for example).
  - **Date format:**
    - Configure the date format to match your preferences, such as yyyy/MM/dd.
  - **Time zone:**
    - **UTC:** Display the date and time in UTC throughout the user interface. Mousing over the date and time displays that information in your local time zone.
    - **Local time zone:** Display the date and time in your local time zone throughout the user interface. Mousing over the date and time displays that information in UTC.

#### Note:

These settings are specific to each user account.

## Enable DNS resolution

To present DNS names instead of IP addresses in the ICA file, follow these steps:

1. Sign in to Web Studio and select **Settings** in the left pane.
2. Turn on the **Enable DNS resolution** setting.

## Set the inactivity timeout for the Studio console

You can set the inactivity duration after which administrators are automatically signed out of the Studio console.

1. Sign in to Web Studio and select **Settings** in the left pane.
2. Type a duration ranging from 10 minutes to 24 hours.
3. To apply this setting, refresh the page or sign out and then sign back in.

## Centralize site management

This feature lets you use one Web Studio console to manage multiple Citrix Virtual Apps and Desktops sites. For more information, see [Enable multiple site management](#).

## User profiles

August 24, 2022

By default, Citrix Profile Management is installed silently on master images when you install the Virtual Delivery Agent, but you do not have to use Profile Management as a profile solution.

To suit your users' varying needs, you can use Citrix Virtual Apps and Desktops policies to apply different profile behavior to the machines in each Delivery Group. For example, one Delivery Group might require Citrix mandatory profiles, whose template is stored in one network location, while another Delivery Group requires Citrix roaming profiles stored in another location with several redirected folders.

- If other administrators in your organization are responsible for Citrix Virtual Apps and Desktops policies, work with them to ensure that they set any profile-related policies across your Delivery Groups.
- Profile Management policies can also be set in Group Policy, in the Profile Management .ini file, and locally on individual virtual machines. These multiple ways of defining profile behavior are read in the following order:
  1. Group Policy (.adm or .admx files)
  2. Citrix Virtual Apps and Desktops policies in the Policy node
  3. Local policies on the virtual machine that the user connects to
  4. Profile Management .ini file

For example, if you configure the same policy in both Group Policy and the Policy node, the system reads the policy setting in Group Policy and ignores the Citrix Virtual Apps and Desktops policy setting.

Whichever profile solution you choose, Director administrators can access diagnostic information and troubleshoot user profiles. For more information, see the [Director](#) documentation.

## Automatic configuration

The desktop type is automatically detected, based on the Virtual Delivery Agent installation and, in addition to the configuration choices you make in Studio, sets Profile Management defaults accordingly.

The policies that Profile Management adjusts are shown in the following table. Any non-default policy settings are preserved and are not overwritten by this feature. Consult the Profile Management documentation for information about each policy. The types of machines that create profiles affect the policies that are adjusted. The primary factors are whether machines are persistent or provisioned, and whether they are shared by multiple users or dedicated to just one user.

Persistent systems have some type of local storage, the contents of which can be expected to persist when the system turns off. Persistent systems might employ storage technology such as SANs to provide local disk mimicking. In contrast, provisioned systems are created “on the fly” from a base disk and some type of identity disk. Local storage is usually mimicked by a RAM disk or network disk, the latter often provided by a SAN with a high speed link. The provisioning technology is generally Citrix Provisioning or Machine Creation Services (or a third-party equivalent). Sometimes provisioned systems have persistent local storage. These are classed as persistent.

Together, these two factors define the following machine types:

- **Both persistent and dedicated.** Examples are single-session OS machines with a static assignment and persistent local storage that are created with Machine Creation Services, physical workstations, and laptops.
- **Both persistent and shared.** Examples are multi-session OS machines that are created with Machine Creation Services, and Citrix Virtual Apps servers.
- **Both provisioned and dedicated.** Examples are single-session OS machines with a static assignment but without persistent storage that are created with Citrix Provisioning Service (in Citrix Virtual Desktops).
- **Both provisioned and shared.** Examples are single-session OS machines with a random assignment that are created with Citrix Provisioning Service (in Citrix Virtual Desktops) and Citrix Virtual Apps servers.

The following Profile Management policy settings are suggested guidelines for the different machine types. They work well in most cases, but you might want to deviate from them as your deployment

requires.

**Important:**

**Delete locally cached profiles on logoff**, **Profile streaming**, and **Always cache** are enforced by the auto-configuration feature. Adjust the other policies manually.

### Persistent machines

| Policy                                   | Both persistent and dedicated | Both persistent and shared |
|------------------------------------------|-------------------------------|----------------------------|
| Delete locally cached profiles on logoff | Disabled                      | Enabled                    |
| Profile streaming                        | Disabled                      | Enabled                    |
| Always cache                             | Enabled (note 1)              | Disabled (note 2)          |
| Active write back                        | Disabled                      | Disabled (note 3)          |
| Process logons of local administrators   | Enabled                       | Disabled (note 4)          |

### Provisioned machines

| Policy                                   | Both provisioned and dedicated | Both provisioned and shared |
|------------------------------------------|--------------------------------|-----------------------------|
| Delete locally cached profiles on logoff | Disabled (note 5)              | Enabled                     |
| Profile streaming                        | Enabled                        | Enabled                     |
| Always cache                             | Disabled (note 6)              | Disabled                    |
| Active write back                        | Enabled                        | Enabled                     |
| Process logons of local administrators   | Enabled                        | Enabled (note 7)            |

1. Because **Profile streaming** is disabled for this machine type, the **Always cache** setting is always ignored.
2. Disable **Always cache**. However, you can ensure that large files are loaded into profiles as soon as possible after logon by enabling this policy and using it to define a file size limit (in MB). Any file this size or larger is cached locally as soon as possible.
3. Disable **Active write back** except to save changes in profiles of users who roam between Citrix Virtual Apps servers. In this case, enable this policy.



4. Disable **Process logons of local administrators** except for Hosted Shared Desktops. In this case, enable this policy.
5. Disable **Delete locally cached profiles on logoff**. This setting retains locally cached profiles. Because the machines are reset at logoff but are assigned to individual users, logons are faster if their profiles are cached.
6. Disable **Always cache**. However, you can ensure that large files are loaded into profiles as soon as possible after logon by enabling this policy and using it to define a file size limit (in MB). Any file this size or larger is cached locally as soon as possible.
7. Enable **Process logons of local administrators** except for profiles of users who roam between Citrix Virtual Apps and Desktops servers. In this case, disable this policy.

## Folder redirection

Folder redirection lets you store user data on network shares other than the location where the profiles are stored. Folder redirection reduces profile size and load time but it might impact network bandwidth. Folder redirection does not require that Citrix user profiles are employed. You can choose to manage user profiles on your own, and still redirect folders.

Configure folder redirection using Citrix policies in Studio.

- Ensure that the network locations used to store the contents of redirected folders are available and have the correct permissions. The location properties are validated.
- Redirected folders are set up on the network and their contents populated from users' virtual desktops at logon.

Configure folder redirection using only Citrix Policies or Active Directory Group Policy Objects, not both. Configuring folder redirection using both policy engines might result in unpredictable behavior.

## Advanced folder redirection

In deployments with multiple operating systems (OSs), you might want some of a user's profile to be shared by each OS. The rest of the profile is not shared and is used only by one OS. To ensure a consistent user experience across the OSs, you need a different configuration for each OS, that is, advanced folder redirection. For example, different versions of an application running on two OSs might need to read or edit a shared file, so you decide to redirect it to a single network location where both versions can access it. Alternatively, because the **Start Menu** folder contents are structured differently in two OSs, you decide to redirect only one folder, not both. This approach separates the **Start Menu** folder and its contents on each OS, ensuring a consistent experience for users.

If your deployment requires advanced folder redirection, you must understand the structure of your users' profile data and determine which parts of it can be shared between OSs. Unpredictable behavior can result unless folder redirection is used correctly.

To redirect folders in advanced deployments:

- Use a separate Delivery Group for each OS.
- Understand where your virtual applications, including those on virtual desktops, store user data and settings, and understand how the data is structured.
- For shared profile data that can safely roam (because it is structured identically in each OS), redirect the containing folders in each Delivery Group.
- For non-shared profile data that cannot roam, redirect the containing folder in only one of the Desktop Groups, typically the one with the most used OS or the one where the data is most relevant. Alternatively, for non-shared data that cannot roam between OSs, redirect the containing folders on both systems to separate network locations.

### Example advanced deployment

The deployment has applications, including versions of Microsoft Outlook and Internet Explorer, running on Windows 10 desktops and applications, including other versions of Outlook and Internet Explorer, delivered by Windows Server 2019. You have already set up two Delivery Groups for the two OSs. Users want to access the same set of **Contacts** and **Favorites** in both versions of the two applications.

**Important:** The following decisions and advice are valid for the OSs and deployment described. In your organization, the folders you choose to redirect and whether you decide to share them depend on various factors that are unique to your specific deployment.

- Using policies applied to the Delivery Groups, you choose the following folders to redirect.

---

| Folder           | Redirected in Windows 10? | Redirected in Windows Server 2019? |
|------------------|---------------------------|------------------------------------|
| My Documents     | Yes                       | Yes                                |
| Application Data | No                        | No                                 |
| Contacts         | Yes                       | Yes                                |
| Desktop          | Yes                       | No                                 |
| Downloads        | No                        | No                                 |
| Favorites        | Yes                       | Yes                                |
| Links            | Yes                       | No                                 |

---

| Folder      | Redirected in Windows 10? | Redirected in Windows Server 2019? |
|-------------|---------------------------|------------------------------------|
| My Music    | Yes                       | Yes                                |
| My Pictures | Yes                       | Yes                                |
| My Videos   | Yes                       | Yes                                |
| Searches    | Yes                       | No                                 |
| Saved Games | No                        | No                                 |
| Start Menu  | Yes                       | No                                 |

---

- For the shared, redirected folders:
  - After analyzing the structure of the data saved by the different versions of Outlook and Internet Explorer, you decide it is safe to share the **Contacts** and **Favorites** folders.
  - You know the structure of the **My Documents**, **My Music**, **My Pictures**, and **My Videos** folders is standard across OSs. So it is safe to store these folders in the same network location for each Delivery Group.
- For the non-shared, redirected folders:
  - You do not redirect the Desktop, Links, Searches, or **Start Menu** folder in the Windows Server Delivery Group because data in these folders is organized differently in the two OSs. It therefore cannot be shared.
  - To ensure predictable behavior of this non-shared data, you redirect it only in the Windows 10 Delivery Group. Windows 10 are used more often by users in their day-to-day work. Users only occasionally access the applications delivered by the Windows Server. Also, in this case the non-shared data is more relevant to a desktop environment rather than an application environment. For example, desktop shortcuts are stored in the **Desktop** folder and might be useful if they originate from a Windows 10 machine but not from a Windows Server machine.
- For the non-redirected folders:
  - You do not want to clutter your servers with users' downloaded files, so you choose not to redirect the Downloads folder
  - Data from individual applications can cause compatibility and performance issues, so you decide not to redirect the Application Data folder

For more information on folder redirection, see [Folder Redirection, Offline Files, and Roaming User Profiles overview](#).

## Folder redirection and exclusions

In Citrix Profile Management (but not in Studio), a performance enhancement allows you to prevent folders from being processed using exclusions. If you use this feature, do not exclude any redirected folders. The folder redirection and exclusion features work together. Ensuring no redirected folders are excluded allows Profile Management to move them back into the profile folder structure and preserves data integrity if you later decide not to redirect them. For more information on exclusions, see [Include and exclude items](#).

## VDA registration

February 5, 2024

### Introduction

**Note:**

In an on-premises environment, VDAs register with a Delivery Controller. In a Citrix Cloud service environment, VDAs register with a Cloud Connector. In a hybrid environment, some VDAs register with a Delivery Controller while others register with a Cloud Connector.

Before a VDA can be used, it must register (establish communication) with one or more Controllers or Cloud Connectors on the site. The VDA finds a Controller or Connector by checking a list called the `ListofDDCs`. The `ListofDDCs` on a VDA contains DNS entries that point that VDA to Controllers or Cloud Connectors on the site. For load balancing, the VDA automatically distributes connections across all Controllers or Cloud Connectors in the list.

Why is VDA registration so important?

- From a security perspective, registration is a sensitive operation. You're establishing a connection between the Controller or Cloud Connector and the VDA. For such a sensitive operation, the expected behavior is to reject the connection if everything is not in perfect shape. You are effectively establishing two separate communication channels: VDA to Controller or Cloud Connector, and Controller or Cloud Connector to VDA. The connection uses Kerberos, so time synchronization and domain membership issues are unforgiving. Kerberos uses Service Principal Names (SPNs), so you cannot use load balanced IP\hostname.
- If a VDA does not have accurate and current Controller or Cloud Connector information as you add and remove Controllers (or Cloud Connectors), the VDA might reject session launches that are brokered by an unlisted Controller or Cloud Connector. Invalid entries can delay the startup

of the virtual desktop system software. A VDA won't accept a connection from an unknown and untrusted Controller or Cloud Connector.

In addition to the `ListofDDCs`, the `ListOfSIDs` (Security IDs) indicates which machines in the `ListofDDCs` are trusted. The `ListofSIDs` can be used to decrease the load on Active Directory or to avoid possible security threats from a compromised DNS server. For more information, see `ListOfSIDs`.

If a `ListofDDCs` specifies more than one Controller or Cloud Connector, the VDA attempts to connect to them in random order. In an on-premises deployment, the `ListofDDCs` can also contain Controller groups. The VDA attempts to connect to each Controller in a group before moving to other entries in the `ListofDDCs`.

Citrix Virtual Apps and Desktops automatically tests the connectivity to configured Controllers or Cloud Connectors during VDA installation. Errors are displayed if a Controller or Cloud Connector cannot be reached. If you ignore a warning that a Controller or Cloud Connector cannot be contacted (or when you do not specify Controller or Cloud Connector addresses during VDA installation), messages remind you.

## Methods for configuring Controller or Cloud Connector addresses

The administrator chooses the configuration method to use when the VDA registers for the first time (the initial registration). During the initial registration, a persistent cache is created on the VDA. During subsequent registrations, the VDA retrieves the list of Controllers or Cloud Connectors from this local cache, unless a configuration change is detected.

The easiest way to retrieve that list during subsequent registrations is by using the auto-update feature. Auto-update is enabled by default. For more information, see `Auto-update`.

There are several methods for configuring Controller or Cloud Connector addresses on a VDA.

- Policy-based (LGPO or GPO)
- Registry-based (manual, Group Policy Preferences (GPP), specified during VDA installation)
- Active Directory OU-based (legacy OU discovery)
- MCS-based (personality.ini)

You specify the initial registration method when you install a VDA. (If you disable auto-update, the method you select during VDA installation is used for subsequent registrations.)

The following graphic shows the **Delivery Controller** page of the VDA installation wizard.

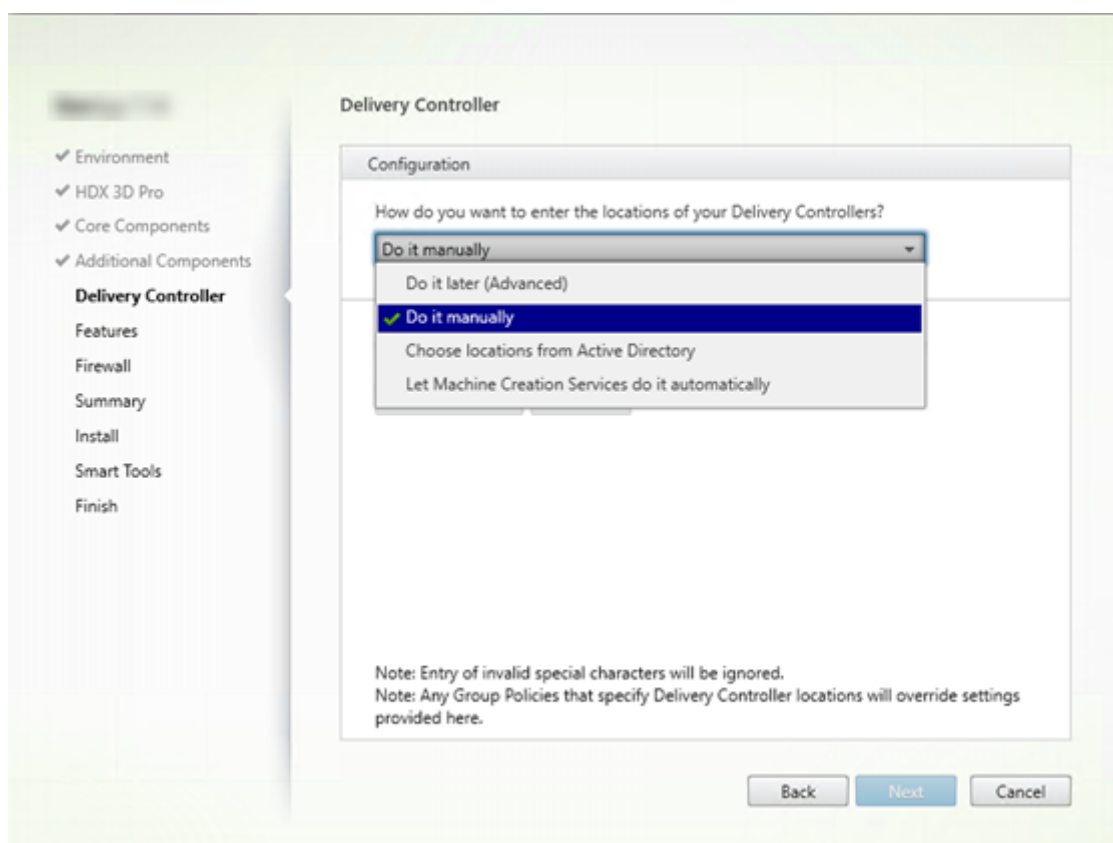

### Policy-based (LGPO\GPO)

Citrix recommends using GPO for initial VDA registration. It has the highest priority. (Although auto-update is listed as the highest priority, auto-update is used only after the initial registration.) Policy-based registration offers the centralizing advantages of using Group Policy for configuration.

To specify this method, complete both of the following steps:

- On the **Delivery Controller** page in the VDA installation wizard, select **Do it later (advanced)**. The wizard reminds you several times to specify Controller addresses, even though you're not specifying them during VDA installation. (VDA registration is that important.)
- Enable or disable policy-based VDA registration through Citrix policy with the [Virtual Delivery Agent Settings > Controllers](#) setting. (If security is your top priority, use the [Virtual Delivery Agent Settings > Controller SIDs](#) setting.)

This setting is stored under `HKLM\Software\Policies\Citrix\VirtualDesktopAgent(ListOfDDCs)`.

## Registry-based

To specify this method, complete one of the following steps:

- On the **Delivery Controller** page in the VDA installation wizard, select **Do it manually**. Then, enter the FQDN of an installed Controller and then click **Add**. If you've installed more Controllers, add their addresses.
- For a command-line VDA installation, use the `/controllers` option and specify the FQDNs of the installed Controllers or Cloud Connectors.

This information is stored in registry value `ListOfDDCs` under registry key `HKLM\Software\Citrix\VirtualDesktopAgent` or `HKLM\Software\Wow6432Node\Citrix\VirtualDesktopAgent`.

You can also configure this registry key manually or use Group Policy Preferences (GPP). This method might be preferable to the policy-based method (for example, if you want conditional processing of different Controllers or Cloud Connectors, such as: use XDC-001 for computer names that begin with XDW-001-).

Update the `ListOfDDCs` registry key, which lists the FQDNs of all the Controllers or Cloud Connectors in the site. (This key is the equivalent of the Active Directory site OU.)

`HKEY_LOCAL_MACHINE\Software\Citrix\VirtualDesktopAgent\ListOfDDCs (REG_SZ)`

If the `HKEY_LOCAL_MACHINE\Software\Citrix\VirtualDesktopAgent` registry location contains both the `ListOfDDCs` and `FarmGUID` keys, `ListOfDDCs` is used for Controller or Cloud Connector discovery. `FarmGUID` is present if a site OU was specified during VDA installation. (This might be used in legacy deployments.)

Optionally, update the `ListOfSIDs` registry key (for more information, see `ListOfSIDs`):

`HKEY_LOCAL_MACHINE\Software\Citrix\VirtualDesktopAgent\ListOfSIDs (REG_SZ)`

Remember: If you also enable policy-based VDA registration through Citrix policy, that overrides settings you specify during VDA installation, because it is a higher-priority method.

## Active Directory OU-based (legacy)

This method is supported primarily for backward compatibility and is not recommended. If you're still using it, Citrix suggests changing to another method.

To specify this method, complete both of the following steps:

- On the **Delivery Controller** page in the VDA installation wizard, select **Choose locations from Active Directory**.

- Use the `Set-ADControllerDiscovery.ps1` script (available on every Controller). Also, configure the `FarmGuid` registry entry on each VDA to point to the right OU. This setting can be configured using Group Policy.

### MCS-based

If you use MCS to provision VMs, MCS sets up the list of Controllers or Cloud Connectors. This feature works with auto-update. When creating the catalog, MCS injects the list of Controllers or Cloud Connectors into the `Personality.ini` file during initial provisioning. Auto-update keeps the list current.

To specify this method, on the **Delivery Controller** page in the VDA installation wizard, select **Let Machine Creation Services do it**.

### Review and recommendations

As best practice:

- Use the Group Policy registration method for initial registration.
- Use auto-update (enabled by default) to keep your list of Controllers up-to-date.
- In a multi-zone deployment, use Group Policy for initial configuration (with at least two Controllers or Cloud Connectors). Point VDAs to Controllers or Cloud Connectors local to (in) their zone. Use auto-update to keep them up-to-date. Auto-update automatically optimizes the `ListOfDDCs` for VDAs in satellite zones.
- List more than one controller on the `ListOfDDCs` registry key, separated by a space or a comma, to prevent registration issues if a Controller is not available. For example:

```
1 DDC7x.xd.local DDC7xHA.xd.local
2
3 32-bit: HKEY_LOCAL_MACHINE \Software\Citrix\VirtualDesktopAgent\
 ListOfDDCs
4
5 HKEY_LOCAL_MACHINE \Software\Citrix\VirtualDesktopAgent\
 ListOfDDCs (REG_SZ)
6 <!--NeedCopy-->
```

- Ensure all values listed under `ListOfDDCs` map to a valid fully qualified domain name to prevent startup registration delays.



## Auto-update

Auto-update (introduced in XenApp and XenDesktop 7.6) is enabled by default. It is the most efficient method for keeping your VDA registrations up-to-date. Although not used for initial registration, the auto-update software downloads and stores the `ListofDDCs` in a persistent cache on the VDA when initial registration occurs. This process is done for each VDA. The cache also holds machine policy information, which ensures that policy settings are retained across restarts.

Auto-update is supported when using MCS or Citrix Provisioning to provision machines, except for Citrix Provisioning server-side cache. Server-side cache is not a common scenario because there is no persistent storage for auto-update cache.

To specify this method:

- Enable or disable auto-update through a Citrix policy containing the setting `Virtual Delivery Agent Settings > Enable auto update of Controllers`. This setting is enabled by default.

How it works:

- Each time a VDA re-registers (for example, after a machine restart), the cache is updated. Each Controller or Cloud Connector also checks the site database every 90 minutes. If a Controller or Cloud Connector has been added or removed since the last check, or if a policy change occurred that affects VDA registration, the Controller or Cloud Connector sends an updated list to its registered VDAs and the cache is updated. The VDA accepts connections from all the Controllers or Cloud Connectors in its most recently cached list.
- If a VDA receives a list that does not include the Controller or Cloud Connector it is registered with (in other words, that Controller or Cloud Connector was removed from the site), the VDA re-registers, choosing among the Controllers or Cloud Connectors in the `ListofDDCs`.

Example:

- A deployment has three Controllers: A, B, and C. A VDA registers with Controller B (which was specified during VDA installation).
- Later, two Controllers (D and E) are added to the site. Within 90 minutes, VDAs receive updated lists and then accept connections from Controllers A, B, C, D, and E. (The load is not spread equally to all Controllers until the VDAs are restarted.)
- Later still, Controller B is moved to another site. Within 90 minutes, VDAs in the original site receive updated lists because there has been a Controller change since the last check. The VDA that originally registered with Controller B (which is no longer on the list) re-registers, choosing among the Controllers in the current list (A, C, D, and E).

In a multi-zone deployment, auto-update in a satellite zone automatically caches all local Controllers first. All Controllers in the primary zone are cached in a backup group. If no local Controllers in the

satellite zone are available, registration is attempted with Controllers in the primary zone.

As shown in the following example, the cache file contains host names and a list of Security IDs (`ListofSIDs`). The VDA does not query SIDs, which reduces the Active Directory load.

```
<?xml version="1.0"?>
<ListOfDDCsListofSids xmlns="http://schemas.datacontract.org/2004/07/Citrix.Cds.BrokerAgent" xmlns:i="http://www.w3.org/2001/XMLSchema-instance">
 - <_x003C_GroupsOfDDCs_x003E_k__BackingField xmlns:d2p1="http://schemas.microsoft.com/2003/10/Serialization/Arrays">
 - <d2p1:ArrayOfstring>
 <d2p1:string>CTX-XDC-002.zugec.lan</d2p1:string>
 <d2p1:string>CTX-XDC-001.zugec.lan</d2p1:string>
 </d2p1:ArrayOfstring>
 </_x003C_GroupsOfDDCs_x003E_k__BackingField>
 - <_x003C_ListOfDDCs_x003E_k__BackingField xmlns:d2p1="http://schemas.microsoft.com/2003/10/Serialization/Arrays">
 <d2p1:string>CTX-XDC-002.zugec.lan</d2p1:string>
 <d2p1:string>CTX-XDC-001.zugec.lan</d2p1:string>
 </_x003C_ListOfDDCs_x003E_k__BackingField>
 - <_x003C_ListofSids_x003E_k__BackingField xmlns:d2p1="http://schemas.microsoft.com/2003/10/Serialization/Arrays">
 <d2p1:string>S-1-5-21-726903571-3621260514-849154371-1119</d2p1:string>
 <d2p1:string>S-1-5-21-726903571-3621260514-849154371-1126</d2p1:string>
 </_x003C_ListofSids_x003E_k__BackingField>
 <_x003C_NonAutoListofDDCsMethod_x003E_k__BackingField>RegistryBasedFarm</_x003C_NonAutoListofDDCsMethod_x003E_k__BackingField>
 <_x003C_NonAutoListofDDCsOrOu_x003E_k__BackingField>CTX-XDC-002.zugec.lan</_x003C_NonAutoListofDDCsOrOu_x003E_k__BackingField>
</ListOfDDCsListofSids>
```

You can retrieve the cache file with a WMI call. However, it is stored in a location that's readable only by the SYSTEM account.

#### Important:

This information is provided only for information purposes. DO NOT MODIFY THIS FILE. Any modifications to this file or folder results in an unsupported configuration.

```
Get-WmiObject -Namespace "Root\Citrix\DesktopInformation"-Class "Citrix_VirtualDesktopInfo"-Property "PersistentDataLocation"
```

If you need to manually configure the `ListofSIDs` for security reasons (as distinct from reducing Active Directory load), you cannot use the auto-update feature. For details, see `ListofSIDs`.

### Exception to auto-update priority

Although auto-update usually has the highest priority of all VDA registration methods and overrides settings for other methods, there is an exception. The `NonAutoListofDDCs` elements in the cache specify the initial VDA configuration method. Auto-update monitors this information. If the initial registration method changes, the registration process skips auto-update, and uses the next-highest configured priority method. This process can be helpful when you move a VDA to another site (for example, during disaster recovery).

### Configuration considerations

View a common VDA registration configuration.

[This is an embedded video. Click the link to watch the video](#)

View VDA registration steps.

[This is an embedded video. Click the link to watch the video](#)

Consider the following when configuring items that can affect VDA registration.

### **Controller or Cloud Connector addresses**

Regardless of which method you use to specify Controllers or Cloud Connectors, Citrix recommends using an FQDN address. An IP address is not considered a trusted configuration, because it's easier to compromise an IP than a DNS record. If you populate the [ListOfSIDs](#) manually, you can use an IP in a [ListOfDDCs](#). However, FQDN is still recommended.

### **Load balancing**

As noted earlier, the VDA automatically distributes connections across all Controllers or Cloud Connectors in the [ListOfDDCs](#). Failover and load balancing functionality is built into the Citrix Brokering Protocol (CBP). If you specify multiple Controllers or Cloud Connectors in your configuration, registration automatically fails over between them, if needed. With auto-update, automatic failover occurs automatically for all VDAs.

For security reasons, you cannot use a network load balancer, such as Citrix ADC. VDA registration uses Kerberos mutual authentication, where the client (VDA) must prove its identity to the service (Controller). However, the Controller or Cloud Connector must prove its identity to the VDA. This means that the VDA and the Controller or Cloud Connector are acting as server and client at the same time. As noted at the beginning of this article, there are two communications channels: VDA to Controller/Cloud Connector and Controller/Cloud Connector to VDA.

A component in this process is called Service Principal Name (SPN), which is stored as a property in an Active Directory computer object. When your VDA connects to a Controller or Cloud Connector, it must specify who it wants to communicate with. This address is an SPN. If you use a load-balanced IP, mutual Kerberos authentication correctly recognizes that the IP does not belong to the expected Controller or Cloud Connector.

For more information, see:

- [Introduction to Kerberos](#)
- [Mutual authentication using Kerberos](#)

### **Auto-update replaces CNAME**

The auto-update feature replaces the CNAME (DNS alias) function from XenApp and XenDesktop versions earlier than 7.x. CNAME functionality is disabled, beginning with XenApp and XenDesktop 7.

Use auto-update instead of CNAME. (If you must use CNAME, see [CTX137960](#). For DNS aliasing to work consistently, do not use both auto-update and CNAME at the same time.)

### Controller/Cloud Connector groups

In certain scenarios, you might want to process Controllers or Cloud Connectors in groups, with one group being preferred and the other group used for a failover if all Controllers/Cloud Connectors fail. Remember that Controllers or Cloud Connectors are randomly selected from the list, so grouping can help enforce preferential use.

These groups are intended for use within a single site (not multiple sites).

Use parentheses to specify groups of Controllers/Cloud Connectors. For example, with four Controllers (two primary and two backups), a grouping might be:

```
(XDC-001.cdz.lan XDC-002.cdz.lan) (XDC-003.cdz.lan XDC-004.cdz.lan)
```

In this example, the Controllers in the first group (001 and 002) are processed first. If both fail, Controllers in the second group (003 and 004) are processed.

For XenDesktop 7.0 or higher, there is an extra step you need to perform to use **Registration Groups** feature. You need to **Prohibit** the **Enable Auto Update of Controller** policy from Studio.

### ListOfSIDs

The list of Controllers that a VDA can contact for registration is the [ListOfDDCs](#). A VDA must also know which Controllers to trust; VDAs do not automatically trust the Controllers in the [ListOfDDCs](#). The [ListOfSIDs](#) (Security IDs) identify the trusted Controllers. VDAs attempt to register only with trusted Controllers.

In most environments, the [ListOfSIDs](#) is generated automatically from the [ListOfDDCs](#). You can use a CDF trace to read the [ListOfSIDs](#).

Generally, there is no need to manually modify the [ListOfSIDs](#). There are several exceptions. The first two exceptions are no longer valid because newer technologies are available.

- **Separate roles for Controllers:** Before zones were introduced in XenApp and XenDesktop 7.7, the [ListOfSIDs](#) was manually configured when only a subset of Controllers was used for registration. For example, if you were using XDC-001 and XDC-002 as XML brokers, and XDC-003 and XDC-004 for VDA registration, you specified all Controllers in the [ListOfSIDs](#), and XDC-003 and XDC-004 in the [ListOfDDCs](#). This is not a typical or recommended configuration. Do not use it in newer environments. Instead, use zones.
- **Reducing Active Directory load:** Before the auto-update feature was introduced in XenApp and XenDesktop 7.6, the [ListOfSIDs](#) was used to reduce the load on domain controllers. By

pre-populating the `ListOfSIDs`, the resolution from DNS names to SIDs can be skipped. However, the auto-update feature removes the need for this work, because this persistent cache contains SIDs. Citrix recommends keeping the auto-update feature enabled.

- **Security:** In some highly secured environments, the SIDs of trusted Controllers were manually configured to avoid possible security threats from a compromised DNS server. However, if you do this, you must also disable the auto-update feature. Otherwise, the configuration from persistent cache is used.

So, unless you have a specific reason, do not modify the `ListOfSIDs`.

If you must modify the `ListOfSIDs`, create a registry key named `ListOfSIDs` (`REG_SZ`) under `HKLM\Software\Citrix\VirtualDesktopAgent`. The value is a list of trusted SIDs, separated by spaces if you have more than one.

In the following example, one Controller is used for VDA registration (`ListOfDDCs`), but two Controllers are used for brokering (`ListOfSIDs`).

| Name                | Type      | Data                                                                                          |
|---------------------|-----------|-----------------------------------------------------------------------------------------------|
| (Default)           | REG_SZ    | (value not set)                                                                               |
| ControllerRegist... | REG_DWORD | 0x00000050 (80)                                                                               |
| HaModeCompu...      | REG_SZ    |                                                                                               |
| HaModeTimeEnd       | REG_SZ    | 0                                                                                             |
| ListOfDDCs          | REG_SZ    | CTX-XDC-001.cdz.lan                                                                           |
| ListOfSIDs          | REG_SZ    | S-1-5-21-2905519506-1074916935-2191873980-1121 S-1-5-21-2905519506-1074916935-2191873980-1118 |
| ProductInstalled    | REG_DWORD | 0x00000008 (8)                                                                                |
| RegistryOverride... | REG_DWORD | 0x00000001 (1)                                                                                |
| ResyncTimeOnF...    | REG_DWORD | 0x00000001 (1)                                                                                |
| StartMenuScanE...   | REG_SZ    | C:\Program Files\Citrix\Virtual Desktop Agent\StartMenuScan.exe                               |

## Controller search during VDA registration

When a VDA tries to register, the Broker Agent first performs a DNS lookup in the local domain to ensure that the specified Controller can be reached.

If that initial lookup doesn't find the Controller, the Broker Agent can start a fallback top-down query in AD. That query searches all domains, and repeats frequently. If the Controller address is invalid (for example, the administrator entered an incorrect FQDN when installing the VDA), that query's activity can potentially lead to a distributed denial of service (DDoS) condition on the domain controller.

The following registry key controls whether the Broker Agent uses the fallback top-down query when it cannot locate a Controller during the initial search.

`HKEY_LOCAL_MACHINE\Software\Policies\Citrix\VirtualDesktopAgent`

- Name: `DisableDdcWildcardNameLookup`
- Type: `DWORD`
- Value: 1 (default) or 0

When set to 1, the fallback search is disabled. If the initial search for the Controller fails, the Broker Agent stops looking. This is the default setting.

When set to 0, the fallback search is enabled. If the initial search for the Controller fails, the fallback top-down search is started.

## LDAP binding sequencing during VDA registration using a read-only domain controller

When a VDA registers with a read-only domain controller (RODC), the Broker Agent must select which Light Directory Access Protocol (LDAP) binding or bindings to ignore. To make this selection, the Broker Agent requires a suitable registry key.

If a registry key is not provided, or the registry key field is empty, VDA registration with the RODC takes longer because it is required to go through the original LDAP binding sequence.

To modify the LDAP binding sequence, the registry key `ListofIgnoredBindings` has been added to `HKEY_LOCAL_MACHINE\Software\Policies\Citrix\VirtualDesktopAgent`. Use of `ListofIgnoredBindings` lets you modify the LDAP binding sequence as necessary, and thereby speed up VDA registration with a RODC.

- Name: `ListofIgnoredBindings`
- Type: `REG_SZ`
- Values: `DefaultPath`, `DomainPath`, `PDCPath`

The value is a list of binding path options, each separated by a comma. The registry key will ignore any values that it does not recognize as valid.

## Troubleshoot VDA registration issues

As noted previously, a VDA must be registered with a Delivery Controller or Cloud Connector to be considered when launching brokered sessions. Unregistered VDAs can result in underutilization of otherwise available resources. There are various reasons a VDA might not be registered, many of which an administrator can troubleshoot. Studio provides troubleshooting information in the catalog creation wizard, and after you create a Delivery Group.

- **Identifying issues during machine catalog creation:** In the catalog creation wizard, after you add existing machines, the list of computer account names indicates whether each machine is suitable for adding to the catalog. Hover over the icon next to each machine to display an informative message about that machine.

If the message identifies a problematic machine, you can either remove that machine (using the **Remove** button), or add the machine. For example, if a message indicates that information was not obtained about a machine (perhaps because it had never registered), you might choose to add the machine anyway.

A catalog's functional level controls which product features are available to machines in the catalog. Using features introduced in new product versions might require a new VDA. Setting a functional level makes all features introduced in that version (and later, if the functional level does not change) available to machines in the catalog. However, machines in that catalog with an earlier VDA version will not be able to register.

- **Identifying issues after creating Delivery Groups:** After you create a Delivery Group, Studio displays details about machines associated with that group.

The details pane for a Delivery Group indicates the number of machines that should be registered but are not. In other words, there might be one or more machines that are powered on and not in maintenance mode, but are not currently registered with a Controller. When viewing a “not registered, but should be” machine, review the **Troubleshoot** tab in the details pane for possible causes and recommended corrective actions.

### More information about troubleshooting VDA registration

- For more information about functional levels, see [VDA versions and functional levels](#).
- For more information about VDA registration troubleshooting, see [CTX136668](#).
- You can also use Citrix Scout health checks to troubleshoot VDA registration and session launch. For details, see [About health checks](#).

## Virtual IP and virtual loopback

November 18, 2023

### Important:

- Windows 10 Enterprise multi-session doesn't support Remote Desktop IP Virtualization (Virtual IP) and we don't support Remote Desktop IP Virtualization or virtual loopback on Windows 10 Enterprise multi-session.
- Remote Desktop IP Virtualization (Virtual IP) isn't supported on cloud-hosted machines. For more information, see [Microsoft](#) documentation.

Remote Desktop IP Virtualization and virtual loopback features are supported on Windows Server 2016, Windows Server 2019, and Windows Server 2022 machines. These features do not apply to Windows desktop OS machines.

The Microsoft Remote Desktop IP Virtualization address feature provides a published application with a unique dynamically assigned IP address for each session. With the Citrix virtual loopback feature,

you can configure applications that depend on communications with localhost (127.0.0.1 by default) to use a unique virtual loopback address in the localhost range (127.\*).

Certain applications, such as CRM and Computer Telephony Integration (CTI), use an IP address for addressing, licensing, identification, or other purposes that require a unique IP address or loopback address. Other applications might bind to a static port, so attempts to launch additional instances of an application in a multiuser environment fail because the port is in use. For such applications to function correctly in a Citrix Virtual Apps environment, a unique IP address is required for each device.

Remote Desktop IP Virtualization and virtual loopback are features independent of each other. You can use either or both.

Administrator action synopsis:

- To use Microsoft Remote Desktop IP Virtualization, enable and configure it on the Windows server. (Citrix policy settings aren't needed.)
- To use Citrix virtual loopback, configure two settings in a Citrix policy.

## Remote Desktop IP Virtualization (Virtual IP)

When Remote Desktop IP Virtualization is enabled and configured on the Windows server, each configured application running in a session appears to have a unique address. Users access these applications on a Citrix Virtual Apps server in the same way that they access any other published application. A process requires Remote Desktop IP Virtualization in either of the following cases:

- The process uses a hard-coded TCP port number
- The process uses Windows sockets and requires a unique IP address or a specified TCP port number

To determine if an application needs to use Remote Desktop IP Virtualization addresses:

1. Obtain the **TCPView** tool from Microsoft. This tool lists all applications that bind specific IP addresses and ports. For more information on TCPView, see [Microsoft documentation](#).
2. Disable the **Resolve IP Addresses** feature so that you see the addresses instead of host names.
3. Launch the application and use **TCPView** to see which IP addresses and ports the application opens and which process names are opening these ports.
4. Configure any processes that open the IP address of the server, 0.0.0.0, or 127.0.0.1.
5. To ensure that an application does not open the same IP address on a different port, launch another instance of the application.

## How Microsoft Remote Desktop (RD) IP virtualization works

- Virtual IP addressing must be enabled on the Microsoft server.



For example, in a Windows Server 2016 environment, from Server Manager, expand **Remote Desktop Services > RD Session Host Connections** to enable the RD IP Virtualization feature and configure the settings to dynamically assign IP addresses using the Dynamic Host Configuration Protocol (DHCP) server on a per-session or per-program basis. For more information on configuring Remote Desktop IP Virtualization, see [Microsoft documentation](#).

- After enabling the feature, at session startup, the server requests dynamically assigned IP addresses from the DHCP server.
- The **RD IP Virtualization** feature assigns IP addresses to remote desktop connections per-session or per-program. If you assign IP addresses for multiple programs, they share a per-session IP address.
- After an address is assigned to a session, the session uses the virtual address rather than the primary IP address for the system whenever the following calls are made: `bind`, `closesocket`, `connect`, `WSAConnect`, `WSAAccept`, `getpeername`, `getsockname`, `sendto`, `WSASendTo`, `WSASocketW`, `gethostbyaddr`, `getnameinfo`, `getaddrinfo`.

When using the Microsoft IP virtualization feature within the Remote Desktop session hosting configuration, applications are bound to specific IP addresses by inserting a “filter” component between the application and Winsock function calls. The application then sees only the correct IP address to use. Any attempt by the application to listen for TCP or UDP communications is bound to its allocated virtual IP address (or loopback address) automatically. Any originating connections opened by the application originate from the IP address bound to the application.

In functions that return an address (such as `GetAddrInfo()`, which a Windows policy controls), if the local host IP address is requested, Remote Desktop IP Virtualization looks at the returned IP address and changes it to the Remote Desktop IP Virtualization address of the session. Applications that attempt to get the IP address of the local server through such name functions see only the unique Remote Desktop IP Virtualization address assigned to that session. This IP address is often used in subsequent socket calls, such as `bind` or `connect`. For more information about Windows policies, see [RDS IP Virtualization in Windows Server](#).

Often, an application requests to bind to a port for listening on the address 0.0.0.0. When an application does this and uses a static port, you can't launch more than one instance of the application. The Remote Desktop IP Virtualization address feature also looks for 0.0.0.0 in these call types. It changes the call to listen on the specific Remote Desktop IP Virtualization address, which enables more than one application to listen on the same port on the same computer because they're all listening on different addresses. The call is changed only if it is in an ICA session and the Remote Desktop IP Virtualization address feature is enabled. For example, if two instances of an application running in different sessions both try to bind to all interfaces (0.0.0.0) and a specific port (such as 9000), they're bound to `VIPAddress1:9000` and `VIPAddress2:9000` and there's no conflict.

## Virtual loopback

Enabling the **Citrix Remote Desktop IP Virtualization loopback policy** settings allows each session to have its own loopback address for communication. When an application uses the localhost address (default = 127.0.0.1) in a Winsock call, the virtual loopback feature simply replaces 127.0.0.1 with 127.X.X.X, where X.X.X is a representation of the session ID + 1. For example, a session ID of 7 is 127.0.0.8. In the unlikely event that the session ID exceeds the fourth octet (more than 255), the address rolls over to the next octet (127.0.1.0), to the maximum of 127.255.255.255.

A process requires virtual loopback in either of the following cases:

- The process uses the Windows socket loopback (localhost) address (127.0.0.1)
- The process uses a hard-coded TCP port number

Use the [virtual loopback policy settings](#) for applications that use a loopback address for interprocess communication. No additional configuration is required. Virtual loopback has no dependency on Virtual IP, so you do not have to configure the Microsoft server.

- Virtual IP loopback support. When enabled, this policy setting allows each session to have its own virtual loopback address. This setting is disabled by default. The feature applies only to applications specified with the Virtual IP virtual loopback programs list policy setting.
- Virtual IP virtual loopback programs list. This policy setting specifies the applications that use the virtual IP loopback feature. This setting applies only when the Virtual IP loopback support policy setting is enabled.

## Related feature

You can use the following registry settings to ensure that virtual loopback is given preference over virtual IP. This feature is called preferred loopback. However, proceed with caution:

- Use preferred loopback only if both Virtual IP and virtual loopback are enabled. Otherwise, you might have unintended results.
- Editing the registry incorrectly can cause serious problems that may require you to reinstall your operating system. Citrix can't guarantee that problems resulting from the incorrect use of the Registry Editor can be solved. Use the Registry Editor at your own risk. Be sure to back up the registry before you edit it.

Run regedit on the servers where the applications reside.

- HKEY\_LOCAL\_MACHINE\SOFTWARE\Wow6432Node\Citrix\VIP
- Name: PreferLoopback, Type: REG\_DWORD, Data: 1
- Name: PreferLoopbackProcesses, Type: REG\_MULTI\_SZ, Data: <list of processes>

## Zones

March 23, 2023

**Note:**

You can manage your Citrix Virtual Apps and Desktops deployment using two management consoles: Web Studio (web-based) and Citrix Studio (Windows-based). This article covers only Web Studio. For information about Citrix Studio, see the equivalent article in Citrix Virtual Apps and Desktops 7 2212 or earlier.

Deployments that span widely dispersed locations connected by a WAN can face challenges due to network latency and reliability. There are two options that mitigate those challenges:

- Deploy multiple sites, each with their own SQL Server site database.

This option is recommended for large enterprise deployments. Multiple sites are managed separately, and each requires its own SQL Server site database. Each site is a separate Citrix Virtual Apps deployment.

- Configure multiple zones within a single site.

Configuring zones can help users in remote regions connect to resources without necessarily forcing their connections to traverse large segments of the WAN. Using zones allows effective site management from a single Web Studio console, Citrix Director, and the site database. This saves the costs of deploying, staffing, licensing, and operating more sites containing separate databases in remote locations.

Zones can be helpful in deployments of all sizes. You can use zones to keep applications and desktops closer to end users, which improves performance. A zone can have one or more Controllers installed locally for redundancy and resiliency, but it is not required.

The number of Controllers configured in the site can affect the performance of some operations, such as adding new Controllers to the site itself. To avoid this, we recommend that you limit the number of zones in your Citrix Virtual Apps or Citrix Virtual Desktops site to no more than 50.

When the network latency of your zones is more than 250 ms RTT, we recommend that you deploy multiple sites instead of zones.

Throughout this article the term local refers to the zone being discussed. For example, “A VDA registers with a local Controller” means that a VDA registers with a Controller in the zone where the VDA is located.

Zones in this release are similar, but not identical to zones in XenApp version 6.5 and earlier. For example, in this implementation of zones, there are no data collectors. All Controllers in the site communi-

cate with one site database in the primary zone. Also, failover and preferred zones work differently in this release.

## **Zone types**

A site always has one primary zone. It can also optionally have one or more satellite zones. Satellite zones can be used for disaster recovery, geographically distant data centers, branch offices, a cloud, or an availability zone in a cloud.

### **Primary zone:**

The primary zone has the default name “Primary”. This zone contains the SQL Server site database (and high availability SQL servers, if used), Web Studio, Director, Citrix StoreFront, Citrix License Server, and Citrix Gateway. Always keep the site database in the primary zone.

The primary zone should have at least two Controllers for redundancy. The primary zone can have VDAs with applications that are tightly coupled with the database and infrastructure.

### **Satellite zone:**

A satellite zone contains one or more VDAs, Controllers, StoreFront servers, and Citrix Gateway servers. Under normal operations, Controllers in a satellite zone communicate directly with the database in the primary zone.

A satellite zone, particularly a large one, might also contain a hypervisor that is used to provision and store machines for that zone. When you configure a satellite zone, you can associate a hypervisor or other service connection with it. (Be sure any catalogs that use that connection are in the same zone.)

A site can have satellite zones of different configurations, based on your unique needs and environment. The following figure illustrates a primary zone and examples of satellite zones.

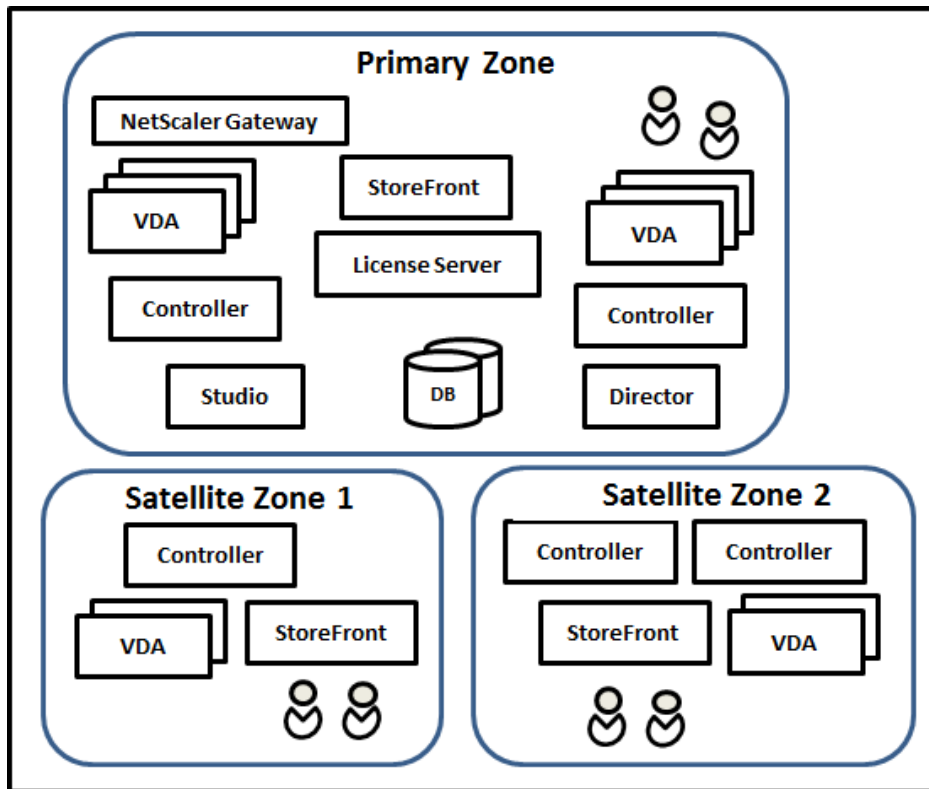

In the illustration:

- **Primary zone:** Contains two Controllers, Web Studio, Director, StoreFront, License Server, and the site database (plus high availability SQL Server deployments). The Primary zone also contains several VDAs and a Citrix Gateway.
- **Satellite zone 1: VDAs with Controller:** Satellite zone 1 contains a Controller, VDAs, and a StoreFront server. VDAs in this satellite zone register with the local Controller. The local Controller communicates with the site database and license server in the primary zone.

If the WAN fails, the Local Host Cache feature allows the Controller in the satellite zone to continue brokering connections to VDAs in that zone. Such a deployment can be effective in an office where workers use a local StoreFront site and the local Controller to access their local resources.

- **Satellite zone 2: VDAs with redundant Controllers:** Satellite zone 2 contains two Controllers, VDAs, and a StoreFront server. This is the most resilient zone type, offering protection against a simultaneous failure of the WAN and one of the local Controllers.

### Where VDAs register and where Controllers fail over

In a site containing primary and satellite zones, with VDAs at minimum version 7.7:

- A VDA in the primary zone registers with a Controller in the primary zone. A VDA in the primary zone never attempts to register with a Controller in a satellite zone.
- A VDA in a satellite zone registers with a local Controller, if possible. (This is considered the preferred Controller.) If no local Controllers are available (for example, because they cannot accept more VDA registrations or they have failed), the VDA will attempt to register with a Controller in the primary zone. In this case, the VDA stays registered in the primary zone, even if a Controller in a satellite zone becomes available again. A VDA in a satellite zone never attempts to register with a Controller in another satellite zone.
- When auto-update is enabled for VDA discovery of Controllers, and you specify a list of Controller addresses during VDA installation, a Controller is randomly selected from that list for initial registration (regardless of which zone the Controller resides in). After the machine with that VDA is restarted, the VDA will start to prefer registering with a Controller in its local zone.
- If a Controller in a satellite zone fails, it fails over to another local Controller, if possible. If no local Controllers are available, it fails over to a Controller in the primary zone.
- If you move a Controller in or out of a zone, and auto-update is enabled, VDAs in both zones receive updated lists indicating which Controllers are local and which are in the primary zone, so they know with whom they can register and accept connections from.
- If you move a catalog to another zone, the VDAs in that catalog re-register with Controllers in the zone where you moved the catalog. (When you move a catalog to another zone, make sure this zone and the zone with the associated host connection are well connected. If there is limited bandwidth or high-latency, move the host connection to the same zone containing the associated machine catalog.)

If all Controllers in the primary zone fail:

- Web Studio cannot connect to the site.
- Connections to VDAs in the primary zone cannot be made.
- Site performance degrades until the Controllers in the primary zone become available.

For sites containing VDA versions earlier than 7.7:

- A VDA in a satellite zone accepts requests from Controllers in their local zone and the primary zone. (VDAs at minimum version 7.7 can accept Controller requests from other satellite zones.)
- A VDA in a satellite zone registers with a Controller in the primary zone or the local zone at random. (VDAs at minimum version 7.7 prefer the local zone.)

## **Zone preference**

To use the zone preference feature, you must be using minimum StoreFront 3.7 and Citrix Gateway 11.0-65.x.

In a multi-zone site, the zone preference feature offers the administrator more flexibility to control which VDA is used to launch an application or desktop.

**How zone preference works**

There are three forms of zone preference. You might prefer to use a VDA in a particular zone, based on:

- Where the application’s data is stored. This is referred to as the application home.
- The location of the user’s home data, such as a profile or home share. This is referred to as the user home.
- The user’s current location (where the Citrix Workspace app is running). This is referred to as the user location.

The following graphic shows an example multi-zone configuration.

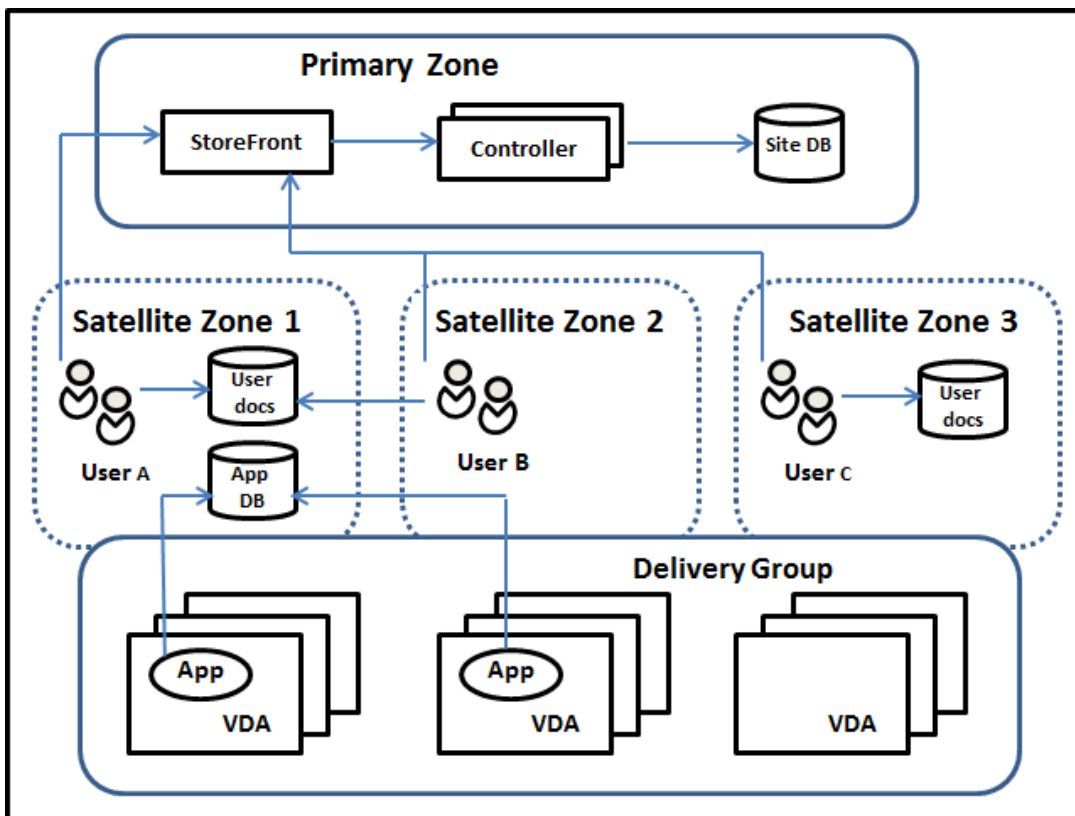

In this example, VDAs are spread among three satellite zones, but they are all in the same Delivery Group. Therefore, the broker might have a choice which VDA to use for a user launch request. This example indicates there are several locations where users can be running their Citrix Workspace app endpoints:

- User A is using a device with Citrix Workspace app in satellite zone 1.

- User B is using a device in satellite zone 2.
- A user's documents can be stored in various locations.
  - Users A and B use a share based in satellite zone 1.
  - User C uses a share from satellite zone C.
  - One of the published applications uses a database located in satellite zone 1.

You associate a user or application with a zone by configuring a home zone for the user or application. The broker in the Delivery Controller then uses those associations to help select the zone where a session will be launched, if resources are available. You can:

- Configure the home zone for a user by adding a user to a zone.
- Configure the home zone for an application by editing the application properties.

A user or an application can have only one home zone at a time. (An exception for users can occur when multiple zone memberships occur because of user group membership; see the “Other considerations” section. However, even in this case, the broker uses only one home zone.)

Although zone preferences for users and applications can be configured, the broker selects only one preferred zone for a launch. The default priority order for selecting the preferred zone is application home > user home > user location. You can restrict the sequence; see Tailoring zone preference. When a user launches an application:

- If that application has a configured zone association (an application home), then the preferred zone is the home zone for that application.
- If the application does not have a configured zone association, but the user has a configured zone association (a user home), then the preferred zone is the home zone for that user.
- If neither the application nor the user has a configured zone association, then the preferred zone is the zone where the user is running a Citrix Workspace app instance (the user location). If that zone is not defined, a random VDA and zone selection is used. Load balancing is applied to all VDAs in the preferred zone. If there is no preferred zone, load balancing is applied to all VDAs in the Delivery Group.

### **Tailoring zone preference**

When you configure (or remove) a home zone for a user or an application, you can also further restrict how zone preference is used.

- **Mandatory user home zone use:** In a Delivery Group, you can specify that a sessions launch in the user's home zone (if configured), with no failover to another zone if the home zone doesn't have available resources. This restriction is helpful when you must avoid the risk of copying large profiles or data files between zones. In other words, you would rather deny a session launch than to launch the session in a different zone.



- **Mandatory application home zone use:** Similarly, when you configure a home zone for an application, you can indicate that the application be launched only in that zone, with no failover to a different zone if resources are not available in the application's home zone.
- **No application home zone, and ignore configured user home zone:** If you do not specify a home zone for an application, you can also indicate that no configured user zones be considered when launching that application. For example, you might prefer that users run an application on a VDA near their device, using the user location zone preference, even though some users might have a different home zone.

### How preferred zones affect session use

When a user launches an application or desktop, the broker prefers using the preferred zone rather than using an existing session.

If the user launching an application or desktop already has a session that is suitable for the resource being launched (for example, that can use session sharing for an application, or a session that is already running the resource being launched), but that session is running on a VDA in a zone other than the preferred zone for the user/application, then the system might create a new session. This satisfies launching in the correct zone (if it has available capacity), ahead of reconnecting to a session in a less-preferred zone for that user's session requirements.

To prevent an orphan session that can no longer be reached, reconnection is allowed to existing disconnected sessions, even if they are in a non-preferred zone.

The order of desirability for sessions to satisfy a launch is:

1. Reconnect to an existing session in the preferred zone.
2. Reconnect to an existing disconnected session in a zone other than the preferred zone.
3. Start a new session in the preferred zone.
4. Reconnect to a connected existing session in a zone other than the preferred zone.
5. Start a new session in a zone other than the preferred zone.

### Other zone preference considerations

- If you configure a home zone for a user group (such as a security group), that group's users (through direct or indirect membership) are associated with the specified zone. However, a user can be a member of multiple security groups, and therefore might have a different home zone configured through other group membership. In such cases, determination of that user's home zone can be ambiguous.

If a user has a configured home zone that was not acquired through group membership, that zone is used for zone preference. Any zone associations acquired through group membership are ignored.

If the user has multiple different zone associations acquired solely through group membership, the broker chooses among the zones randomly. Once the broker makes this choice, that zone is used for subsequent session launches, until the user's group membership changes.

- The user location zone preference requires detection of Citrix Workspace app on the endpoint device by the Citrix Gateway through which that device is connecting. The Citrix Gateway must be configured to associate ranges of IP addresses with particular zones, and discovered zone identity must be passed through StoreFront to the Controller.

For more information about zone preference, see [Zone preference internals](#).

### **Considerations, requirements, and best practice**

- You can place the following items in a zone: Controllers, machine catalogs, host connections, users, and applications. If a catalog uses a host connection, be sure the catalog and the connection are in the same zone. (However, with a low-latency high-bandwidth connection available, they can be in different zones.)
- When you place items in a satellite zone it affects how the site interacts with them and with other objects related to them.
  - When Controllers are placed into a satellite zone, it is assumed that those machines have good (local) connectivity to hypervisors and VDAs in the same zone. Controllers in that satellite zone are then used in preference to Controllers in the primary zone for handling those hypervisors and VDA machines.
  - When a hypervisor connection is placed into a satellite zone, it is assumed that all the hypervisors managed via that hypervisor connection also reside in that satellite zone. Controllers in that satellite zone are then used in preference to Controllers in the primary zone when communicating with that hypervisor connection.
  - When a machine catalog is placed into a satellite zone, it is assumed that all the VDA machines in that catalog are in the satellite zone. Local Controllers are used in preference to Controllers in the primary zone when attempting to register with the site, after the Controller list auto-update mechanism has activated after the first registration of each VDA.
  - Citrix Gateway instances can also be associated with zones. This is done as part of the StoreFront Optimal HDX Routing configuration rather than, as for the other elements described here, as part of the site configuration. When a Citrix Gateway is associated with a zone, it is preferred to be used when HDX connections to VDA machines in that zone are used.
- When you create a production site and then create the first catalog and Delivery Group, all items are in the primary zone –you cannot create satellite zones until after you complete that initial

setup. (If you create an empty site, the primary zone will initially contain only a Controller. You can create satellite zones before or after creating a catalog and Delivery Group.)

- When you create the first satellite zone containing one or more items, all other items in your site remain in the primary zone.
- The primary zone is named 'Primary' by default; you can change that name. Although Web Studio indicates which zone is the primary zone, it is best practice to use an easily identifiable name for the primary zone. You can reassign the primary zone (that is, make another zone the primary zone), but it should always contain the site database and any high availability servers.
- Always keep the site database in the primary zone.
- After you create a zone, you can later move items from one zone to another. This flexibility allows you to potentially separate items that work best in close proximity. For example, moving a catalog to a different zone than the connection (host) that creates the machines in the catalog, can affect performance. Consider potential unintended effects before moving items between zones. Keep a catalog and the host connection it uses in the same zone, or in zones which are well connected (for example, via a low-latency and high-bandwidth network).
- For optimal performance, install Web Studio and Director only in the primary zone. You can access Web Studio and Director from a satellite zone (for example, a satellite zone containing Controllers to use as failover if the primary zone becomes inaccessible) because they are web application.
- Ideally, Citrix Gateway in a satellite zone is used for user connections coming into that zone from other zones or external locations, although you can use it for connections within the zone.
- Remember: To use the zone preference feature, you must be using minimum StoreFront 3.7 and Citrix Gateway 11.0-65.x.

### **Connection quality limits**

The Controllers in the satellite zone perform SQL interactions directly with the site database. This imposes some limits on the quality of the link between the satellite zone and the primary zone containing the site database. The specific limits are relative to the number of VDAs and user sessions on those VDAs that are deployed in the satellite zone. So satellite zones with only a few VDAs and sessions can function with a poorer-quality connection to the database than satellite zones with large numbers of VDAs and sessions.

For more information, see [Latency and SQL Blocking Query Improvements](#).

## The impact of latency on brokering performance

Although zones allow users to be on higher-latency links, providing that there is a local broker, the additional latency inevitably impacts end-user experience. For most work that users do, they experience slowness caused by round trips between Controllers in the satellite zone and the site database.

For launching applications, extra delays occur while the session brokering process identifies suitable VDAs to send session launch requests to.

## Create and manage zones

A Full Administrator can perform all zone creation and management tasks. However, you can also create a custom role that allows you to create, edit, or delete a zone. Moving items between zones does not require zone-related permissions (except zone read permission); however, you must have edit permission for the items you are moving. For example, to move a catalog from one zone to another, you must have edit permission for that catalog. For more information, see [Delegated administration](#).

**If you use Citrix Provisioning:** The Citrix Provisioning console is not aware of zones, so we recommend using Web Studio to create catalogs for satellite zones. Create the catalog in Web Studio, specifying the correct satellite zone. Then use the Citrix Provisioning console to provision machines in that catalog. (If you create the catalog using the Citrix Provisioning wizard, the catalog is placed in the primary zone. You must use Web Studio to move it to the satellite zone later.)

## Create a zone

1. Sign in to Web Studio.
2. Select **Zones** in the left pane.
3. Select **Create Zone** in the action bar.
4. Enter a name for the zone, and a description (optional). The name must be unique within the site.
5. Select the items to place in the new zone. You can filter or search the list of items from which you can select. You can also create an empty zone; simply do not select any items.
6. Click **Save**.

As an alternative to this method, you can select one or more items in Web Studio and then select **Create Zone** in the action bar.

## Change a zone name or description

1. Sign in to Web Studio.
2. Select **Zones** in the left pane.

3. Select a zone in the middle pane and then select **Edit Zone** in the action bar.
4. Change the zone name, description, or both. If you change the name of the primary zone, make sure the zone remains easily identifiable as the primary zone.
5. Click **Save** or **Apply**.

### **Move items from one zone to another zone**

1. Sign in to Web Studio.
2. Select **Zones** in the left pane.
3. Select a zone in the middle pane, and then select one or more items.
4. Drag the items to the destination zone or select **Move Items** in the action bar and then specify which zone to move them to.

A confirmation message lists the items you selected and asks if you are sure you want to move all of them.

**Remember:** When a catalog uses a host connection to a hypervisor or other service, place both the catalog and the connection in the same zone. Otherwise, performance can be affected. If you move one, move the other, too.

### **Delete a zone**

A zone must be empty before it can be deleted. You cannot delete the primary zone.

1. Sign in to Web Studio.
2. Select **Zones** in the left pane.
3. Select a zone in the middle pane.
4. Select **Delete Zone** from the action bar. If the zone is not empty (it contains items), you are asked to choose the zone where those items will be moved.
5. Confirm the deletion.

### **Add a home zone for a user**

Configuring a home zone for a user is also known as *adding a user to a zone*.

1. Sign in to Web Studio.
2. Select **Zones** in the left pane, and then select a zone in the middle pane.
3. Select **Add Users to Zone** in the action bar.
4. In the **Add Users to Zone** dialog box, click **Add** and then select the users and user groups to add to the zone. If you specify users who already have a home zone, a message offers two choices:

**Yes** = add only those users you specified who do not have a home zone; **No** = return to the user selection dialog.

5. Click **OK**.

For users with a configured home zone, you can require that sessions launch only from their home zone:

1. Create or edit a delivery group.
2. On the **Users** page, select the **Sessions must launch in a user's home zone, if configured** check box.

All sessions launched by a user in that delivery group must launch from machines in that user's home zone. If a user in the delivery group does not have a configured home zone, this setting has no effect.

### **Remove a home zone for a user**

This procedure is also known as removing a user from a zone.

1. Sign in to Web Studio.
2. Select **Zones** in the left pane, and then select a zone in the middle pane.
3. Select **Remove Users from Zone** in the action bar.
4. In the **Add Users to Zone** dialog box, click **Remove** and then select the users and groups to remove from the zone. This action removes the users only from the zone; those users remain in the delivery groups and application groups to which they belong.
5. Confirm the removal when prompted.

### **Manage home zones for applications**

Configuring a home zone for an application is also known as adding an application to a zone. By default, in a multi-zone environment, an application does not have a home zone.

An application's home zone is specified in the application's properties. You can configure application properties when you add the application to a group or later.

- When [creating a Delivery Group](#), [creating an Application Group](#), or [adding applications to existing groups](#), select **Properties** on the **Applications** page of the wizard.
- To change an application's properties after the application is added, select **Applications** in the left pane. Select an application and then select **Edit Application Properties** in the action bar.

On the **Zones** page of the application's properties/settings:

- If you want the application to have a home zone:
  - Select **Use the selected zone to decide** radio button and then select the zone.

- If you want the application to launch only from the selected zone (and not from any other zone), select the check box under the zone selection.
- If you do not want the application to have a home zone:
  - Select the **Do not configure a home zone** radio button.
  - If you do not want the broker to consider any configured user zones when launching this application, select the check box under the radio button. In this case, neither application or user home zones are used to determine where to launch this application.

### **Other actions that include specifying zones**

After you create at least one satellite zone, you can specify a zone when you add a host connection or create a catalog.

Usually, the primary zone is the default. When using Machine Creation Services to create a catalog, the zone that is configured for the host connection is automatically selected.

If the site contains no satellite zones, the primary zone is assumed and the zone selection box does not appear.

## **Monitor**

May 4, 2022

Administrators and help desk personnel can monitor Citrix Virtual Apps and Desktops Sites using a variety of features and tools. Using these tools, you can monitor:

- User sessions and session use
- Logon performance
- Connections and machines, including failures
- Load evaluation
- Historical trends
- Infrastructure

### **Citrix Director**

Director is a real-time web tool that you can use to monitor and troubleshoot, and to perform support tasks for end users.

For details, see the [Director](#) articles.

## Configuration Logging

Configuration Logging allows administrators to keep track of administrative changes to a Site. Configuration Logging can help administrators diagnose and troubleshoot problems after configuration changes are made, assist change management and track configurations, and report administration activity.

You can view and generate reports about logged information from Studio. You can also view logged items in Director with the Trend View to provide notifications of configuration changes. This feature is useful for administrators who do not have access to Studio.

The Trends View gives historical data of configuration changes over a period of time so administrators can assess what changes were made to the Site, when they were made, and who made them to find the cause of an issue. This view sorts configuration information into three categories:

- Connection Failures
- Failed Single-session Machines
- Failed Multi-session Machines

For details about how to enable and configure Configuration Logging, see [Configuration Logging](#). The [Director](#) articles describe how to view logged information from that tool.

## Event logs

Services within Citrix Virtual Apps and Desktops log events that occur. Event logs are used to monitor and troubleshoot operations.

For details, see [Event logs](#). Individual feature articles might also contain event information.

## Configuration logging

November 21, 2023

Configuration logging is a feature that captures site configuration changes and administrative activities to the database. The feature is enabled by default. You can use the logged content to:

- Diagnose and troubleshoot problems after configuration changes are made. The log provides a breadcrumb trail.
- Assist change management and track configurations.
- Report administration activity.



You set configuration logging preferences, display configuration logs, and generate HTML and CSV reports from Citrix Studio. You can filter configuration log displays by date ranges and full text search results. Mandatory logging, when enabled, prevents configuration changes from being made unless they can be logged. With appropriate permission, you can delete entries from the configuration log. You cannot use the configuration logging feature to edit log content.

Configuration logging uses a PowerShell SDK and the Configuration Logging Service. The Configuration Logging Service runs on every Controller in the site. If one Controller fails, the service on another Controller automatically handles logging requests.

By default, the configuration logging feature is enabled, and uses the database that is created when you create the site (the site configuration database). You can specify a different location for the database. The configuration logging Database supports the same high availability features as the site configuration Database.

Access to configuration logging is controlled through delegated administration, with the Edit Logging Preferences and View Configuration Logs permissions.

Configuration logs are localized when they are created. For example, a log created in English is read in English, regardless of the locale of the reader.

## What is logged

Configuration changes and administrative activities initiated from Studio, Director, and PowerShell scripts are logged. Examples of logged configuration changes include working with (creating, editing, deleting assigning):

- Machine catalogs
- Delivery groups (including changing power management settings)
- Administrator roles and scopes
- Host resources and connections
- Citrix policies through Studio

Examples of logged administrative changes include:

- Power management of a virtual machine or a user desktop
- Studio or Director sending a message to a user

The following operations are not logged:

- Autonomic operations such as pool management power-on of virtual machines.
- Policy actions implemented through the Group Policy Management Console (GPMC); use Microsoft tools to view logs of those actions.
- Changes made through the registry, direct access of the database, or from sources other than Studio, Director, or PowerShell.

- When the deployment is initialized, configuration logging becomes available when the first Configuration Logging Service instance registers with the Configuration Service. Therefore, the early stages of configuration are not logged (for example, when the database schema is obtained and applied, when a hypervisor is initialized).

## Manage configuration logging

By default, configuration logging uses the database that is created when you create a site (also known as the site configuration database). Citrix recommends that you use a separate location for the configuration logging database (and the monitoring database) for the following reasons:

- The backup strategy for the configuration logging database is likely to differ from the backup strategy for the site configuration database.
- The volume of data collected for configuration logging (and the Monitoring Service) might adversely affect the space available to the site configuration database.
- It splits the single point of failure for the three databases.

Product editions that do not support configuration logging do not have a Logging node in Studio.

## Enable and disable configuration logging and mandatory logging

By default, configuration logging is enabled, and mandatory logging is disabled.

1. Sign in to Web Studio and select **Logging** in the left pane.
2. Select **Preferences** in the action bar. The configuration logging dialog box contains database information and indicates whether configuration logging and mandatory logging are enabled or disabled.
3. Select the desired action:

To enable configuration logging, select **Enable**. This is the default setting. If the database cannot be written to, the logging information is discarded, but the operation continues.

To disable configuration logging, select **Disable**. If logging was previously enabled, existing logs remain readable with the PowerShell SDK.

To enable mandatory logging, select **Prevent changes to the site configuration when the database is not available**. No configuration change or administrative activity that is normally logged is allowed unless it can be written in the configuration logging database. You can enable mandatory logging only when configuration logging is enabled (when **Enable** is selected). If the Configuration Logging Service fails, and high availability is not in use, mandatory logging is assumed. In such cases, operations that would normally be logged are not performed.

To disable mandatory logging, select **Allow changes when to the site configuration when the database is not available**. Configuration changes and administrative activities are allowed, even if the configuration logging database cannot be accessed. This is the default setting.

## Change the configuration logging database location

You cannot change the database location when mandatory logging is enabled, because the location change includes a brief disconnect interval that cannot be logged.

1. Create a database server, using a supported SQL Server version.
2. Sign in to Web Studio and select **Logging** in the left pane.
3. Select **Preferences** in the action bar.
4. In the Logging Preferences dialog box, select **Change logging database**.
5. In the Change Logging Database dialog box, specify the location of the server containing the new database server. See [Database address formats](#) for valid formats.
6. To allow Studio to create the database, click **OK**. When prompted, click **OK**, and the database is created automatically. Studio attempts to access the database using the current Studio user's credentials. If that fails, you are prompted for the database user's credentials. Studio then uploads the database schema to the database. (The credentials are retained only during database creation.)
7. To create the database manually, click **Generate database script**. The generated script includes instructions for manually creating the database. Ensure that the database is empty and that at least one user has permission to access and change the database before uploading the schema.

The configuration logging data in the previous database is not imported to the new database. Logs cannot be aggregated from both databases when retrieving logs. The first log entry in the new configuration logging database indicates that a database change occurred, but it does not identify the previous database.

## Display configuration log content

When initiating configuration changes and administrative activities, the high level operations created by Studio and Director are listed in the upper middle pane in Studio. A high level operation results in one or more service and SDK calls, which are low level operations. When you select a high level operation in the upper pane, the lower pane displays the low level operations.

If an operation fails before completion, the log operation might not be completed in the database. For example, a start record will have no corresponding stop record. In such cases, the log indicates that there is missing information. When you display logs based on time ranges, incomplete logs are shown if the data in the logs matches the criteria. For example, if all logs for the last five days are requested and a log exists with a start time in the last five days but has no end time, it is included.

When using a script that calls PowerShell cmdlets, if you create a low level operation without specifying a parent high level operation, configuration logging creates a surrogate high level operation.

To display configuration log content, select **Logging** in the Studio navigation pane. By default, the center pane lists the log content chronologically (newest entries first), separated by date. You can:

- Sort the display by column header.
- Filter the display by specifying a day interval, or entering text in the **Search** box. To return to the standard display after using search, clear the text in the **Search** box.

## Generate reports

You can generate CSV and HTML reports containing configuration log data.

- The CSV report contains all the logging data from a specified time interval. The hierarchical data in the database is flattened into a single CSV table. No aspect of the data has precedence in the file. No formatting is used and no human readability is assumed. The file (named MyReport) contains the data in a universally consumable format. CSV files are often used for archiving data or as a data source for a reporting or data manipulation tool such as Microsoft Excel.
- The HTML report provides a human-readable form of the logging data for a specified time interval. It provides a structured, navigable view for reviewing changes. An HTML report comprises two files, named Summary and Details. Summary lists high level operations: when each operation occurred, by whom, and the outcome. Clicking a **Details** link next to each operation takes you to the low level operations in the Details file, which provides additional information.

To generate a configuration log report, select **Logging** in the Studio navigation pane, and then select **Create custom report** in the action bar.

- Select the date range for the report.
- Select the report format: CSV, HTML, or both.
- Browse to the location where you want to save the report.

## Delete configuration log content

To delete the configuration log, you must have certain delegated administration and SQL Server database permissions.

- **Delegated administration:** You must have a delegated administration role that allows the deployment configuration to be read. The Full administrator role has this permission. A custom role must have Read Only or Manage selected in the Other permissions category.

To create a backup of the configuration logging data before deleting it, the custom role must also have Read Only or Manage selected in the Logging Permissions category.

- **SQL Server database:** You must have a SQL server login with permission to delete records from the database. There are two ways to do this:
  - Use a SQL Server database login with a sysadmin server role, which allows you to perform any activity on the database server. Alternatively, the `serveradmin` or `setupadmin` server roles allow you to perform deletion operations.
  - If your deployment requires more security, use a non-sysadmin database login mapped to a database user who has permission to delete records from the database.
    1. In SQL Server Management Studio, create a SQL Server login with a server role other than 'sysadmin.'
    2. Map the login to a user in the database. SQL Server automatically creates a user in the database with the same name as the login.
    3. In Database role membership, specify at least one of the role members for the database user: `ConfigurationLoggingSchema_ROLE` or `dbowner`.

For more information, see the SQL Server Management Studio documentation.

To delete the configuration logs:

1. Sign in to Web Studio and select **Logging** in the left pane.
2. Select **Delete logs** in the action bar.
3. You are asked if you want to create a backup of the logs before they are deleted. If you choose to create a backup, browse to the location where the backup archive is saved. The backup is created as a CSV file.

After the configuration logs are cleared, the log deletion is the first activity posted to the empty log. That entry provides details about who deleted the logs, and when.

## View API and PowerShell logs

To monitor API requests made during your current session, click the **APIs** tab. API logs are cleared after you sign out of Web Studio.

To view PowerShell commands corresponding to UI actions you've taken during the day, click the **PowerShell** tab.

## Associate metadata with configuration logs

You can attach metadata to configuration logs by associating a `name-value` pair called `MetadataMap` with the log records.

**Note:**

- You can only attach metadata to high-level operation objects.
- Metadata is associated with the existing records at the time of execution.

**Set the metadata**

Run the PowerShell command `Set-LogHighLevelOperationMetadata` to associate a log record with the `MetadataMap`.

`Set-LogHighLevelOperationMetadata` takes the following parameters:

- **Id:** ID of the high-level operation.
- **InputObject:** The high-level operations to which you add the metadata. This is an alternative to the `Id` parameter where a high-level operation object or list of objects is passed to the PowerShell command.

---

**Name:** Property name of the metadata to be added. The property must be unique for the high-level operation specified. The property cannot contain any of the following characters `()\;/:;#.*?=<>`.

---

- 
- **Value:** Value for the property.
- **Map:** Dictionary of (name, value) pairs for the properties. This is an alternative to setting the metadata using the `-Name` and `-Value` parameters.

For example, to attach the metadata to all the high-level log records with Id 40, run the following PowerShell command:

```
Get-LogHighLevelOperation - Id 40 | Set-LogHighLevelOperationMetadata
-Name A -Value B
```

To attach the metadata to the high-level record with the user `abc@example.com`, run the following PowerShell command:

```
Get-LogHighLevelOperation - User `abc@example.com` | Set-LogHighLevelOperation
-Name C -Value D
```

## Retrieve using the metadata

Run the following PowerShell commands to use the associated metadata to retrieve the log records:

- Search by key and value:

```
Get-LogHighLevelOperation -Metadata "Key:Value"
```

- Search by value any key:

```
Get-LogHighLevelOperation -Metadata "*:Value"
```

- Search by key and any value:

```
Get-LogHighLevelOperation -Metadata "Key:*"
```

## Remove the metadata

Run the PowerShell command `Remove-LogHighLevelOperationMetadata` to remove the associated metadata.

`Remove-LogHighLevelOperationMetadata` takes the following parameters:

- **Id**: ID of the high-level operation.
- **InputObject**: The high-level operations to which you add the metadata. This is an alternative to the `Id` parameter where a high-level operation object or list of objects is passed to the PowerShell command.
- **Name**: Property name of the metadata to be removed. Set to `$null` to remove all the metadata for the specified object.
- **Map**: Dictionary of (name, value)-pairs for the properties. This can be either a hashtable (created with `@{"name1"="val1";"name2"="val2"}`) or a string dictionary (created with `new-object "System.Collections.Generic.Dictionary[String, String]"`). The properties whose names match the keys in the map are removed.

## Event logs

March 4, 2021

The following articles list and describe events that can be logged by services within Citrix Virtual Apps and Desktops.

This information is not comprehensive. Readers should check individual feature articles for additional event information.

- [Citrix Broker Service events](#)
- [Citrix FMA Service SDK events](#)
- [Citrix Configuration Service events](#)
- [Citrix Delegated Administration Service events](#)

## Director

April 19, 2022

Director is a monitoring and troubleshooting console for Citrix Virtual Apps and Desktops.

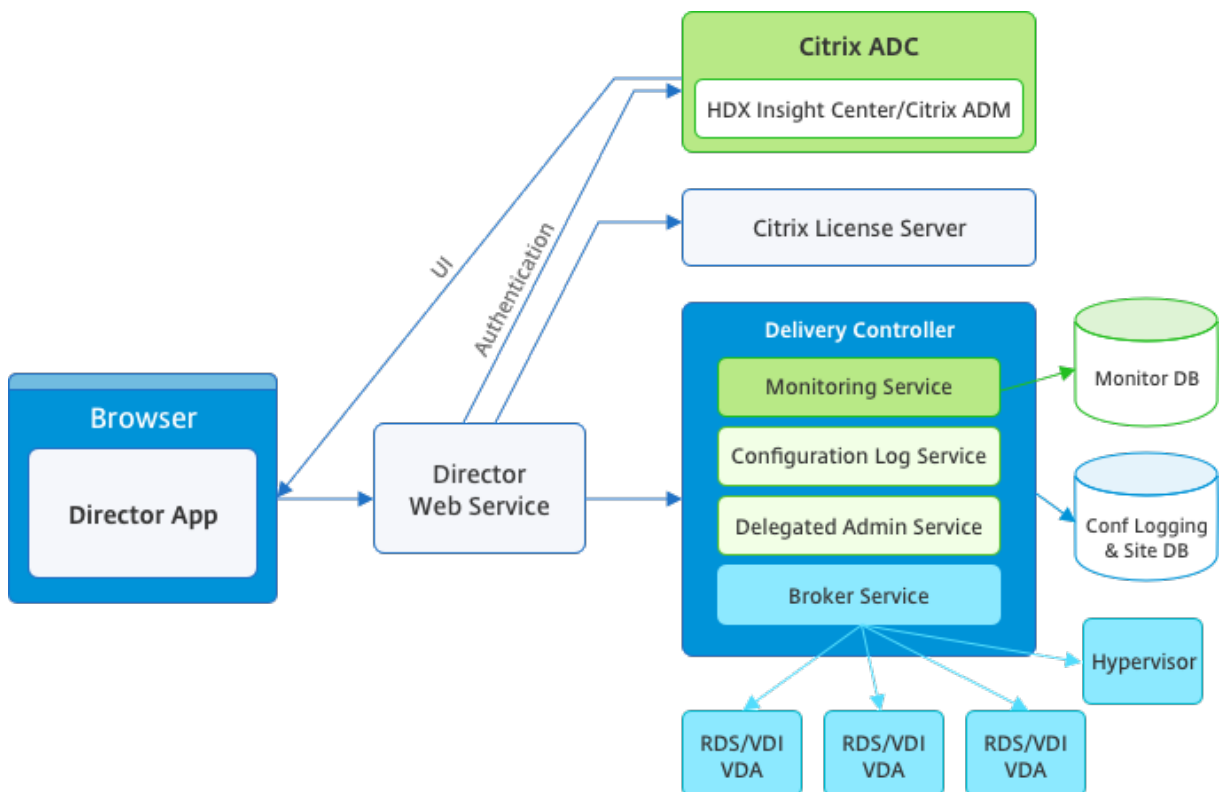

Director can access:

- Real-time data from the Broker Agent using a unified console integrated with Analytics, Performance Manager, and Network Inspector. The following analytics are powered by Citrix ADM to identify bottlenecks due to the network in your Citrix Virtual Apps or Desktops environment:
  - Performance management for health and capacity assurance
  - Historical trending and network analysis
- Historical data stored in the Monitor database to access the Configuration Logging database.



- ICA data from the Citrix Gateway using Citrix ADM.
  - Gain visibility into the end-user experience for virtual applications, desktops, and users for Citrix Virtual Apps or Desktops.
  - Correlate network data with application data and real-time metrics for effective troubleshooting.
  - Integrate with Citrix Virtual Desktop 7 Director monitoring tool.

Director uses a troubleshooting dashboard that provides real-time and historical health monitoring of the Citrix Virtual Apps or Desktops Site. This feature allows you to see failures in real time, providing a better idea of what the end users are experiencing.

For more information regarding the compatibility of Director features with Delivery Controller (DC), VDA and any other dependent components, see [Feature compatibility matrix](#).

**Note:**

With the disclosure of the Meltdown and Spectre speculative execution side-channel vulnerabilities, Citrix recommends that you install relevant mitigation patches. These patches might impact SQL Server performance. For more information, see the Microsoft support article, [Protect SQL Server from attacks on Spectre and Meltdown side-channel vulnerabilities](#). Citrix recommends that you test the scale and plan your workloads before rolling out the patches in your production environments.

Director is installed by default as a website on the Delivery Controller. For prerequisites and other details, see the [System requirements](#) documentation for this release. For specific information on the installation and configuration of Director, see [Install and configure Director](#).

## Log on to Director

The Director website is at https or <http://<Server FQDN>/Director>.

If one of the Sites in a multi-site deployment is down, the logon takes a little longer while it attempts to connect to the Site that is down.

## Use Director with PIV smart card authentication

Director now supports Personal Identity Verification (PIV) based smart card authentication to log on. This feature is useful for organizations and government agencies that use smart card based authentication for access control.

Smart card authentication requires specific configuration on the Director server and in the Active Directory. The configuration steps are detailed in [Configure PIV smart card authentication](#).

**Note:**

Smart card authentication is supported only for users from the same Active Directory domain.

After performing the required configuration, you can log on to Director using a smart card:

1. Insert your smart card into the smart card reader.
2. Open a browser and go to the Director URL, <https://<directorfqdn>/Director>.
3. Select a valid user certificate from the displayed list.
4. Enter your smart card token.

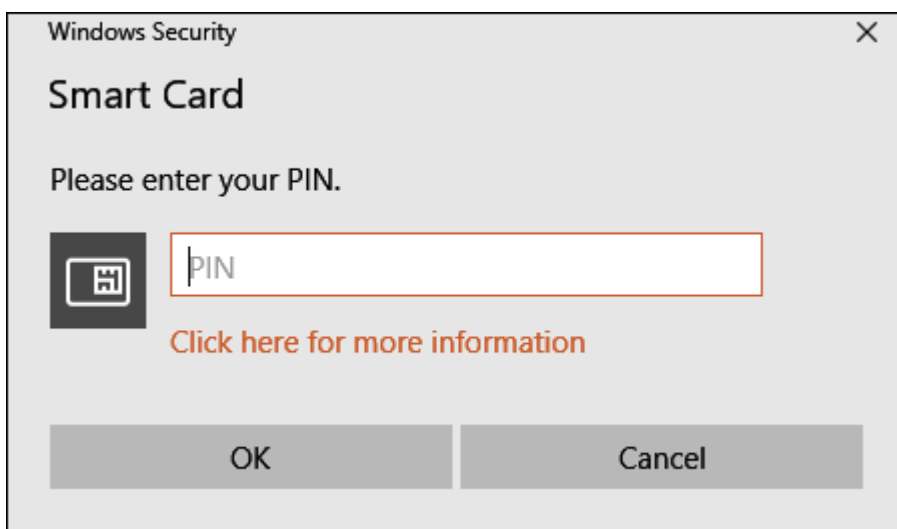

5. After you are authenticated, you can access Director without keying extra credentials on the Director logon page.

## Use Director with Integrated Windows Authentication

With Integrated Windows Authentication (IWA), domain-joined users gain direct access to Director without rekeying their credentials on the Director logon page. The prerequisites for working with Integrated Windows Authentication and Director are:

- Enable Integrated Windows Authentication on the IIS website that hosts Director. When you install Director, Anonymous and Forms Authentications are enabled. To support Integrated Windows Authentication and Director, disable Anonymous Authentication and enable Windows Authentication. Forms Authentication must remain set to Enabled for authentication of non-domain users.
  1. Start IIS manager.
  2. Go to **Sites > Default Web Site > Director**.

3. Select **Authentication**.
4. Right-click **Anonymous Authentication**, and select **Disable**.
5. Right-click **Windows Authentication**, and select **Enable**.

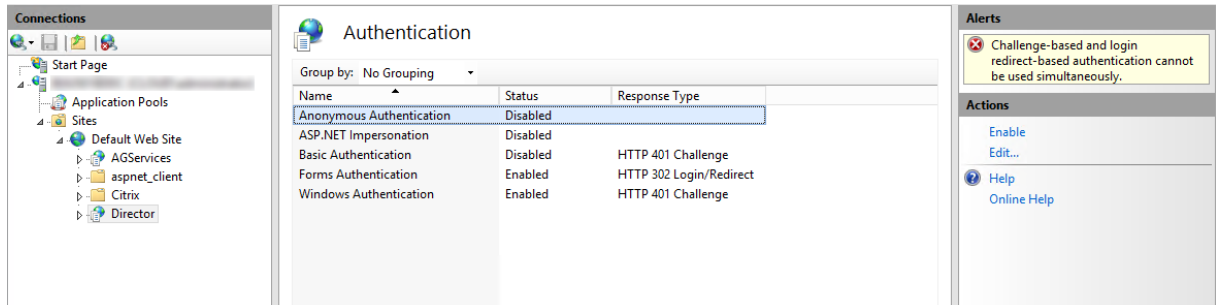

- Configure Active Directory delegation permission for the Director machine. Configuration is only required if Director and the Delivery Controller are installed on separate machines.
  1. On the Active Directory machine, open the Active Directory Management Console.
  2. In the Active Directory Management Console navigate to **Domain Name > Computers**. Select the Director machine.
  3. Right-click and select **Properties**.
  4. In Properties, select the **Delegation** tab.
  5. Select the option, **Trust this computer for delegation to any service (Kerberos only)**.
- The browser that is used to access Director must support Integrated Windows Authentication. Additional configuration steps might be required in Firefox and Chrome. For more information, refer to the browser documentation.
- The Monitoring Service must be running Microsoft .NET Framework 4.5.1 or a later supported version listed in the System Requirements for Director. For more information, see [System Requirements](#).

When a user logs off Director or if the session times out, the logon page is displayed. From the logon page, the user can set the Authentication type to **Automatic logon** or **User credentials**.

## Interface views

Director provides different views of the interface tailored to particular administrators. Product permissions determine what is displayed and the commands available.

For example, help desk administrators see an interface tailored to help desk tasks. Director allows help desk administrators to search for the user reporting an issue and display activity associated with that user. For example, status of the user's applications and processes. They can resolve issues quickly by performing actions such as ending an unresponsive application or process, shadowing operations on the user's machine, restarting the machine, or resetting the user profile.

In contrast, full administrators see and manage the entire Site and can perform commands for multiple users and machines. The Dashboard provides an overview of the key aspects of a deployment, such as the status of sessions, user logons, and the Site infrastructure. Information is updated every minute. If issues occur, details appear automatically about the number and type of failures that have occurred.

For more information about the various roles and their permissions in Director, see [Delegated Administration and Director](#)

## Usage data collection by Google Analytics

The Director Service starts using Google Analytics to collect usage data after Director is installed. Statistics regarding the usage of the Trends pages and OData API call analytics are collected. Analytics collection complies with the [Citrix Privacy Policy](#). Data collection is enabled by default when you install Director.

To opt out of the Google Analytics data collection, edit the registry key on the machine where Director is installed. If the registry key doesn't exist, create and set it to the desired value. Refresh the Director instance after changing the registry key value.

**Caution:** Using the Registry Editor incorrectly can cause serious problems that might require you to reinstall your operating system. Citrix cannot guarantee that problems resulting from the incorrect use of the Registry Editor can be solved. Use the Registry Editor at your own risk. Citrix recommends that you back up Windows Registry before changing it.

Location: HKEY\_LOCAL\_MACHINE\Software\Citrix\Director

Name: DisableGoogleAnalytics

Value: 0 = enabled(default), 1 = disabled

You can use the following PowerShell cmdlet to disable data collection by Google Analytics:

```
1 New-Item HKLM:\SOFTWARE\Citrix -Name Director
2
3 New-ItemProperty HKLM:\SOFTWARE\Citrix\Director -Name
 DisableGoogleAnalytics -PropertyType DWORD -Value 1
```

## New features guide

Director has an in-product guide that uses [Pendo](#) to give an insight into the new features released in the current version of Director. The quick overview coupled with appropriate in-product messages helps you understand what's new in the product.

To opt out of this feature, edit the registry key, as described below on the machine where Director is installed. If the registry key doesn't exist, create and set it to the desired value. Refresh the Director instance after changing the registry key value.

**Caution:**

Using the Registry Editor incorrectly can cause serious problems that might require you to reinstall your operating system. Citrix cannot guarantee that problems resulting from the incorrect use of the Registry Editor can be solved. Use the Registry Editor at your own risk. Citrix recommends that you back up Windows Registry before changing it.

Location: HKEY\_LOCAL\_MACHINE\Software\Citrix\Director

Name: DisableGuidedHelp

Value: 0 = enabled(default), 1 = disabled

You can use the following PowerShell cmdlet to disable the in-product guide:

```
1 New-Item HKLM:\SOFTWARE\Citrix -Name Director
2
3 New-ItemProperty HKLM:\SOFTWARE\Citrix\Director -Name DisableGuidedHelp
 -PropertyType DWORD -Value 1
```

## Install and configure

February 2, 2022

### Install Director

Install Director using the full product ISO Installer for Citrix Virtual Apps and Desktops, which checks for prerequisites, installs any missing components, sets up the Director website, and performs basic configuration. For prerequisites and other details, see the [System requirements](#) documentation for this release. This release of Director is not compatible with Virtual Apps deployments earlier than 6.5 or Virtual Desktops deployments earlier than 7.

The default configuration provided by the ISO installer handles typical deployments. If Director was not included during installation, use the ISO installer to add Director. To add any additional components, rerun the ISO installer and select the components to install. For information on using the ISO installer, see [Install core components](#) in the installation documentation. Citrix recommends that you install using the full product ISO installer only, not the .MSI file.

When Director is installed on the Controller, it is automatically configured with localhost as the server address, and Director communicates with the local Controller by default. To install Director on a dedicated server that is remote from a Controller, you are prompted to enter the FQDN or IP address of a Controller.

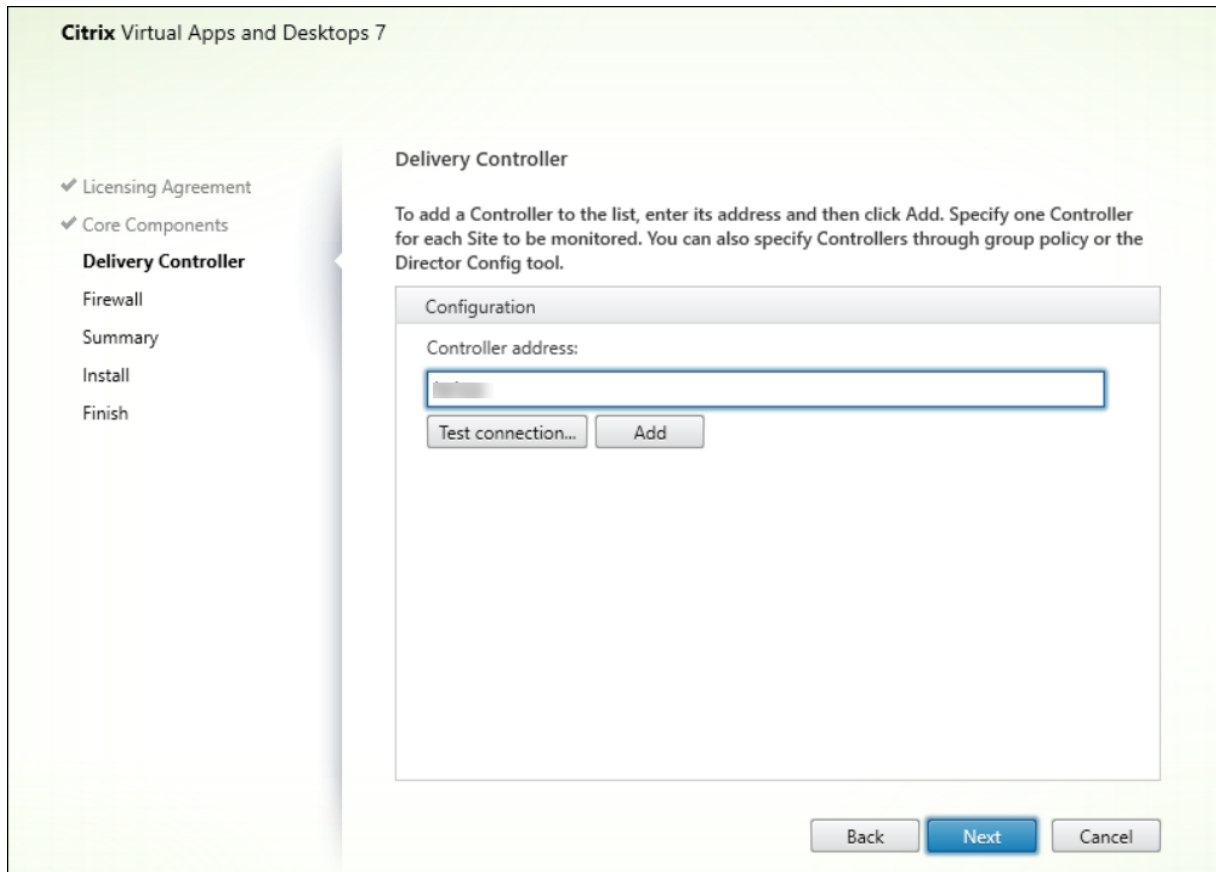

**Note:**

Click **Add** to add the Controller to be monitored.

Director communicates with that specified Controller by default. Specify only one Controller address for each site that you monitor. Director automatically discovers all other Controllers in the same site and falls back to those other Controllers if the Controller you specified fails.

**Note:**

Director does not load balance among Controllers.

To secure the communications between the browser and the Web server, Citrix recommends that you implement TLS on the IIS website hosting Director. Refer to the Microsoft IIS documentation for instructions. Director configuration is not required to enable TLS.

## Deploy and configure Director

When Director is used in an environment containing more than one site, be sure to synchronize the system clocks on all the servers where Controllers, Director, and other core components are installed. Otherwise, the sites might not display correctly in Director.

### Important:

To protect the security of user names and passwords sent using plain text through the network, allow Director connections using only HTTPS, and not HTTP. Certain tools are able to read plain text user names and passwords in HTTP (unencrypted) network packets, which can create a potential security risk for users.

## Configure permissions

To log on to Director, administrators with permissions for Director must be Active Directory domain users and must have the following rights:

- Read rights in all Active Directory forests to be searched (see [Advanced configuration](#)).
- Configured Delegated Administrator roles (see [delegated administration and Director](#)).
- To shadow users, administrators must be configured using a Microsoft group policy for Windows Remote Assistance. In addition:
  - When installing VDAs, ensure that the Windows Remote Assistance feature is enabled on all user devices (selected by default).
  - When you install Director on a server, ensure that Windows Remote Assistance is installed (selected by default). However, it is disabled on the server by default. The feature does not need to be enabled for Director to provide assistance to end users. Citrix recommends leaving the feature disabled to improve security on the server.
  - To enable administrators to initiate Windows Remote Assistance, grant them the required permissions by using the appropriate Microsoft Group Policy settings for Remote Assistance. For information, see [CTX127388: How to Enable Remote Assistance for Desktop Director](#).

## Advanced configuration

March 24, 2023

Director can support multi-forest environments spanning a forest configuration where users, Delivery Controllers (DCs), VDAs, and Directors are located in different forests. This requires proper setup of trust relationships among the forests and configuration settings.

## Recommended configuration in a multi-forest environment

The recommended configuration requires creation of outgoing and incoming forest trust relationships among the forests with domain-wide authentication.

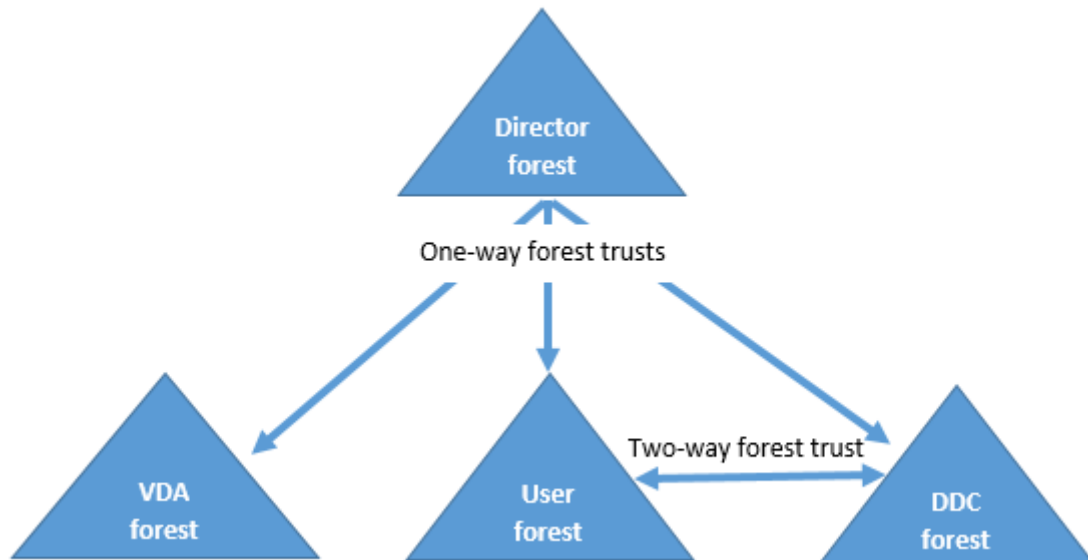

The trust relationship from the Director enables you to troubleshoot issues in user sessions, VDAs, and Delivery Controllers located in different forests.

Advanced configuration required for Director to support multiple forests is controlled through settings defined in Internet Information Services (IIS) Manager.

### Important:

When you change a setting in IIS, the Director service automatically restarts and logs off users.

To configure advanced settings using IIS:

1. Open the Internet Information Services (IIS) Manager console.
2. Go to the Director website under the Default website.
3. Double-click **Application Settings**.
4. Double-click a setting to edit it.
5. Click **Add** to add a new setting.

Director uses Active Directory to search for users and to look up more user and machine information. By default, Director searches the domain or forest in which:

- The administrator's account is a member.
- The Director web server is a member (if different).

Director attempts to perform searches at the forest level using the Active Directory global catalog. If you do not have permissions to search at the forest level, only the domain is searched.



Searching or looking up data from another Active Directory domain or forest requires that you explicitly set the domains or forests to be searched. Configure the following Applications setting to the Director website in the IIS Manager:

```
1 Connector.ActiveDirectory.Domains = (user),(server)
```

The value attributes user and server represent the domains of the Director user (the administrator) and Director server, respectively.

To enable searches from an extra domain or forest, add the name of the domain to the list, as shown in this example:

```
1 Connector.ActiveDirectory.Domains = (user),(server),\<domain1\>,\<
 domain2\>
```

For each domain in the list, Director attempts to perform searches at the forest level. If you do not have permissions to search at the forest level, only the domain is searched.

### Domain local group configuration

Most Citrix Service Providers (CSPs) have similar environment set-ups consisting of the VDAs, DCs, and Director in the Infrastructure forest. The users or user-group records belong to the Customer forest. A one-way outgoing trust exists from the Infrastructure forest to the Customer forest.

CSP administrators typically create a domain local group in the Infrastructure forest and add the users or user groups in the Customer forest to this domain local group.

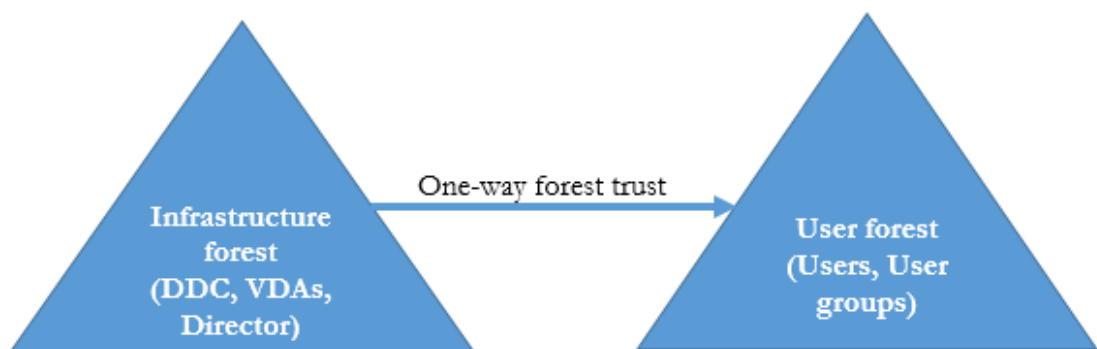

Director can support a multi-forest set-up like this and monitor the sessions of users configured using domain local groups.

1. Add the following Applications settings to the Director website in IIS Manager:

```
1 Connector.ActiveDirectory.DomainLocalGroupSearch= true
2
3 DomainLocalGroupSearchDomains= \<domain1\>,\<domain2\>
```

<domain1><domain2> are names of the forests in which the domain local group exists.

2. Assign the domain local group to delivery groups in Web Studio.
3. Restart IIS and log on to Director again for the changes to take effect. Now, Director can monitor and show the sessions of these users.

## Add sites to Director

If Director is already installed, configure it to work with multiple sites. To configure, use the IIS Manager Console on each Director server to update the list of server addresses in the application settings.

Add an address of a Controller from each site to the following setting:

```
1 Service.AutoDiscoveryAddresses = SiteAController,SiteBController
2 <!--NeedCopy-->
```

SiteAController and SiteBController are the addresses of Delivery Controllers from two different sites.

## Disable the visibility of running applications in the Activity Manager

By default, the Activity Manager in Director displays a list of all running applications for a user's session. This information is viewed by all administrators that have access to the Activity Manager feature in Director. For Delegated Administrator roles, this includes Full Administrator, delivery group Administrator, and Help Desk Administrator.

To protect the privacy of users and the applications they are running, you can disable the **Applications** tab to list running applications.

### Warning:

Editing the registry incorrectly can cause serious problems that might require you to reinstall your operating system. Citrix does not guarantee that problems resulting from the incorrect use of the Registry Editor can be solved. Use the Registry Editor at your own risk. Be sure to back up the registry before you edit it.

1. On the VDA, modify the registry key at HKEY\_LOCAL\_MACHINE\Software\Citrix\Director\TaskManagerDataDis By default, the key is set to 1. Change the value to 0, which means the information is not collected from the VDA and hence not displayed in the Activity Manager.
2. On the server with Director installed, modify the setting that controls the visibility of running applications. By default, the value is "true" which allows visibility of running applications in the Applications tab. Change the value to "false" which disables visibility. This option affects only

the Activity Manager in Director, not the VDA.  
Modify the value of the following setting:  
UI.TaskManager.EnableApplications = false

**Important:**

To disable the view of running applications, make both changes to ensure that the data is not displayed in the Activity Manager.

## Configure PIV smart card authentication

March 20, 2024

This article lists the configuration required on the Director Server and in the Active Directory to enable the smart card authentication feature.

**Note:**

Smart card authentication is supported only for users from the same Active Directory domain.

### Director server configuration

Perform the following configuration steps on the Director server:

1. Install and enable the Client Certificate Mapping Authentication. Follow the **Client Certificate Mapping authentication using Active Directory** instructions in the Microsoft document, [Client Certificate Mapping Authentication](#).
2. Disable Forms Authentication on the Director site.  
Start IIS Manager.  
Go to **Sites > Default Web Site > Director**.  
Select **Authentication**.  
Right-click **Forms Authentication**, and select **Disable**.

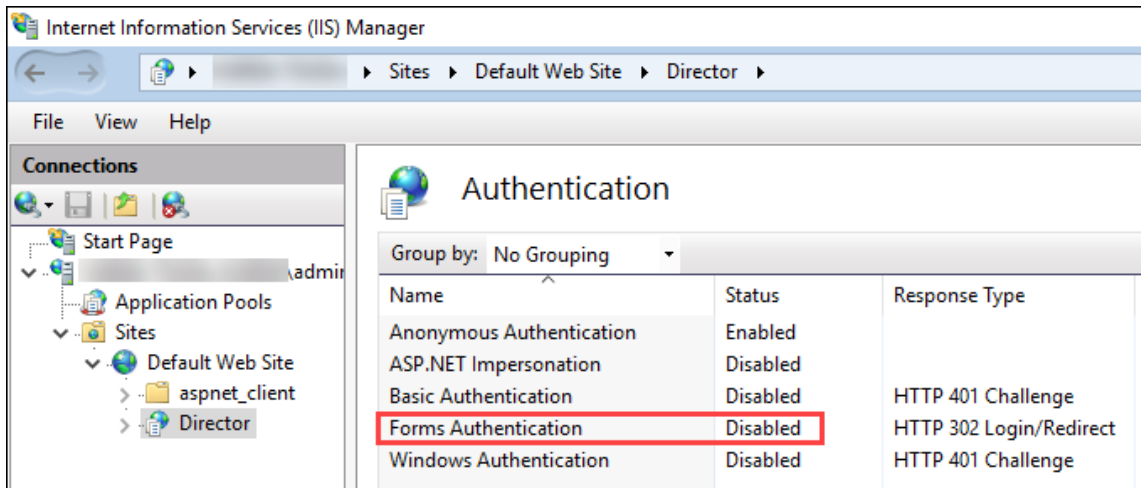

3. Configure the Director URL for the more secure https protocol (instead of HTTP) for client certificate authentication.
  - a) Start IIS Manager.
  - b) Go to **Sites > Default Web Site > Director**.
  - c) Select **SSL Settings**.
  - d) Select **Require SSL** and **Client certificates > Require**.

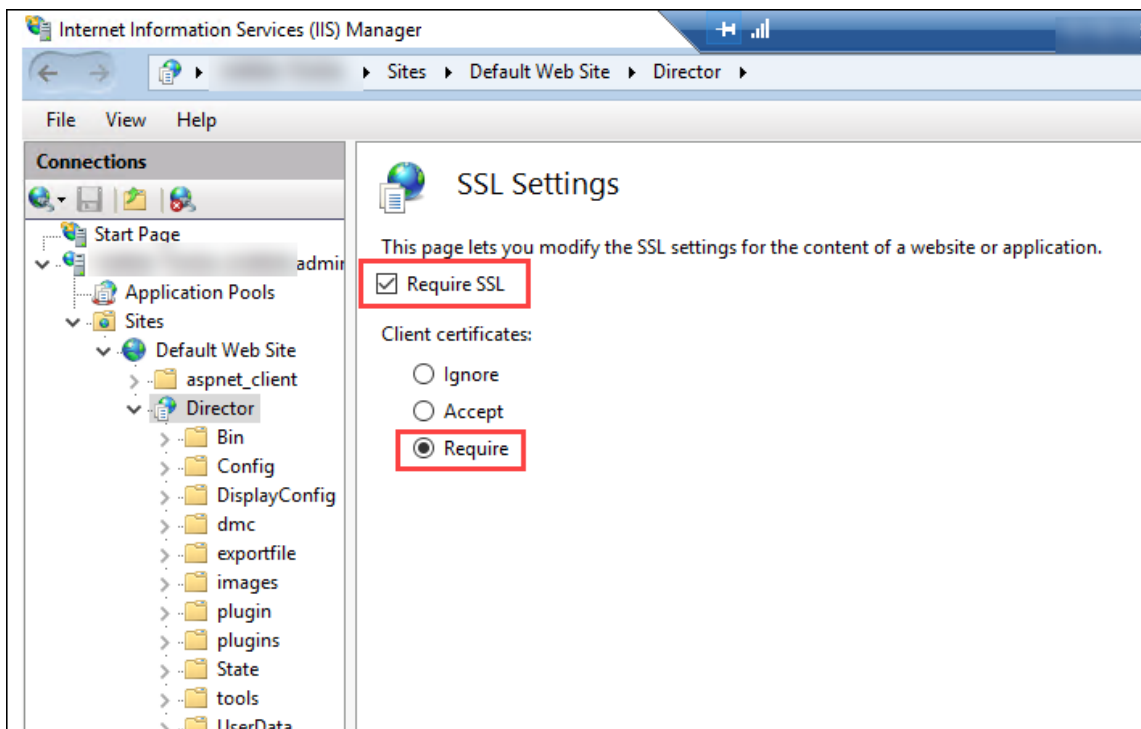

4. Update web.config. Open the web.config file (available in c:\inetpub\wwwroot\Director) using a text editor.

Under the `<system.webServer>` parent element, add the following snippet as the first child element:

```

1 <defaultDocument>
2 <files>
3 <add value="LogOn.aspx"/>
4 </files>
5 </defaultDocument>

```

### Active Directory configuration

By default the Director application runs with the **Application Pool** identity property. Smart card authentication requires delegation for which the Director application identity must have Trusted Computing Base (TCB) privileges on the service host.

Citrix recommends that you create a separate service account for Application Pool identity. Create the service account and assign TCB privileges as per the instructions in the Microsoft MSDN article, [Protocol Transition with Constrained Delegation Technical Supplement](#).

Assign the newly created service account to the Director application pool. The following figure shows the properties dialog of a sample service account, Domain Pool.

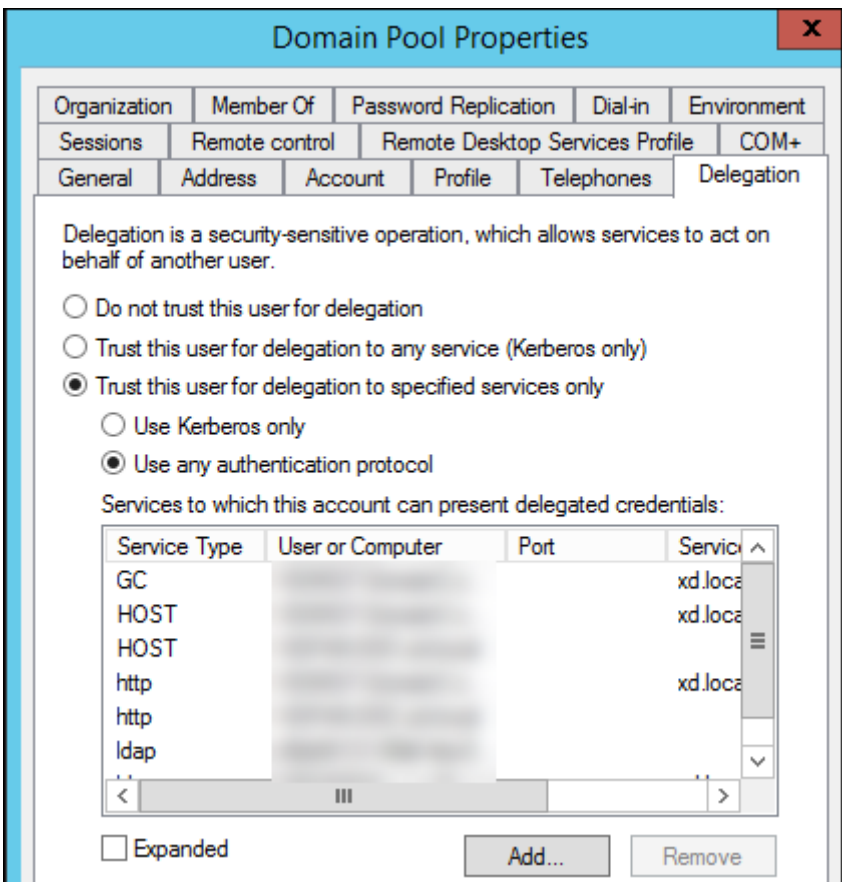

Configure the following services for this account:

- Delivery Controller: HOST, HTTP
- Director: HOST, HTTP
- Active Directory: GC, LDAP

To configure,

1. In the user account properties dialog, click **Add**.
2. In the **Add Services** dialog, click Users or Computers.
3. Select the Delivery Controller host name.
4. From the **Available services** list, select HOST and HTTP **Service Type**.

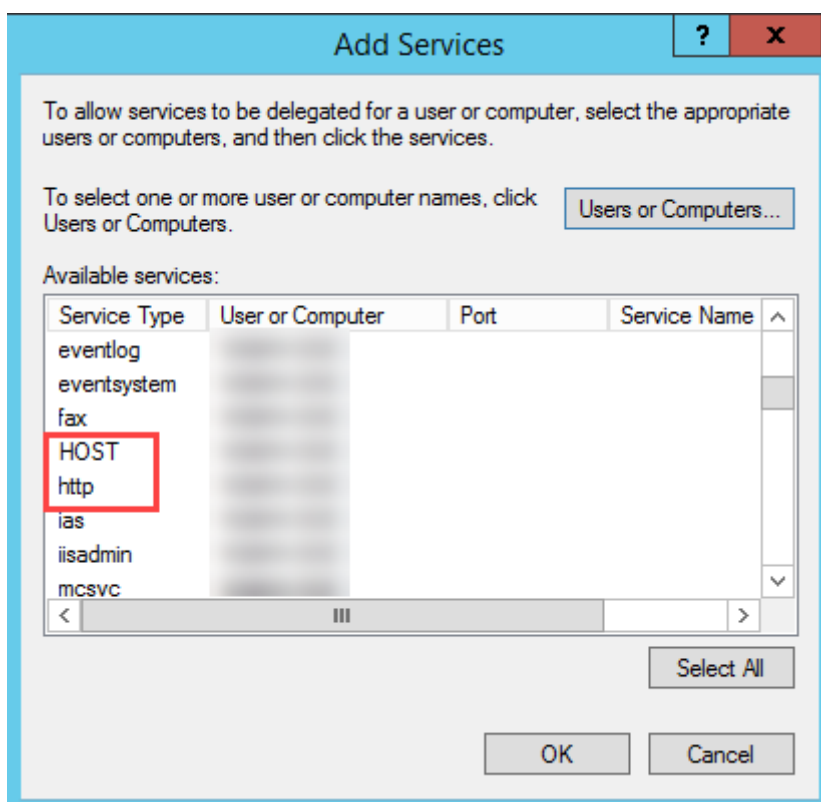

Similarly, add Service Types for **Director** and **Active Directory** hosts.

### Create Service Principal Name records

You must create a service account for each Director server and load-balanced Virtual IPs (VIP) used to access a pool of Director servers. You must create service principal name (SPN) records to configure a delegation to the newly created service account.

- Use the following command to create an SPN record for a Director server:

```
1 setspn -a http/<directorServer>.<domain_fqdn> <domain>\<
 DirectorAppPoolServiceAcct>
2
3 <!--NeedCopy-->
```

- Use the following command to create an SPN record for a load-balanced VIP:

```
1 setspn -S http/<DirectorFQDN> <domain>\<
 DirectorAppPoolServiceAcct>
2
3 <!--NeedCopy-->
```

- Use the following command to view or test the created SPNs:

```
1 setspn -l <DirectorAppPoolServiceAcct>
2
3 <!--NeedCopy-->
```

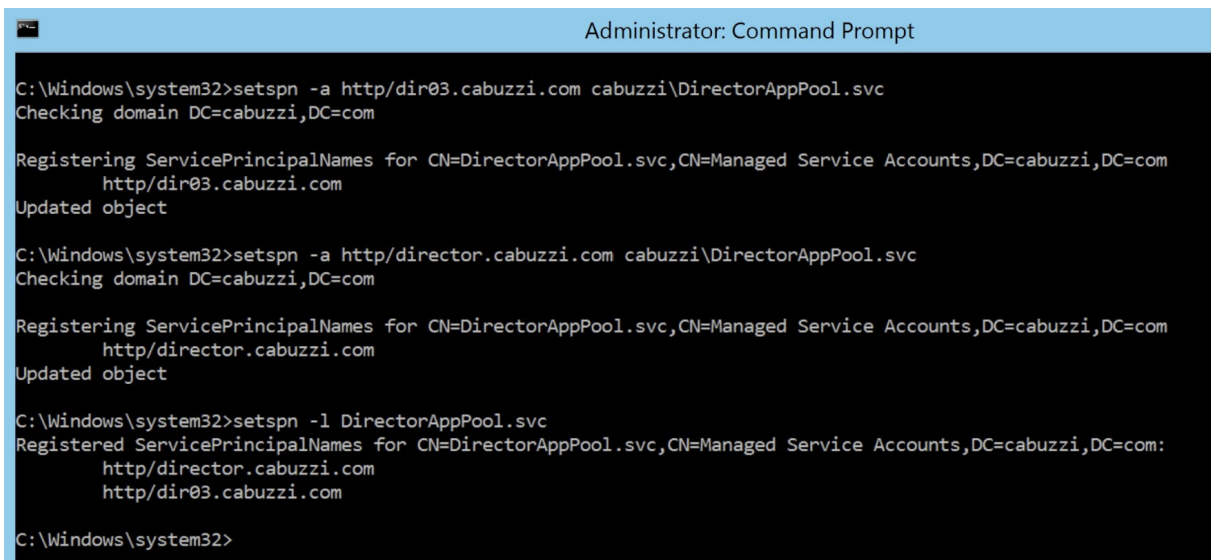

```
Administrator: Command Prompt
C:\Windows\system32>setspn -a http/dir03.cabuzzi.com cabuzzi\DirectorAppPool.svc
Checking domain DC=cabuzzi,DC=com

Registering ServicePrincipalNames for CN=DirectorAppPool.svc,CN=Managed Service Accounts,DC=cabuzzi,DC=com
http/dir03.cabuzzi.com
Updated object

C:\Windows\system32>setspn -a http/director.cabuzzi.com cabuzzi\DirectorAppPool.svc
Checking domain DC=cabuzzi,DC=com

Registering ServicePrincipalNames for CN=DirectorAppPool.svc,CN=Managed Service Accounts,DC=cabuzzi,DC=com
http/director.cabuzzi.com
Updated object

C:\Windows\system32>setspn -l DirectorAppPool.svc
Registered ServicePrincipalNames for CN=DirectorAppPool.svc,CN=Managed Service Accounts,DC=cabuzzi,DC=com:
http/director.cabuzzi.com
http/dir03.cabuzzi.com

C:\Windows\system32>
```

- Select the Director virtual directory in the left pane and double click **Application Settings**. Inside the Application Settings window, click **Add** and ensure **AllowKerberosConstrainedDelegation** is set to 1.

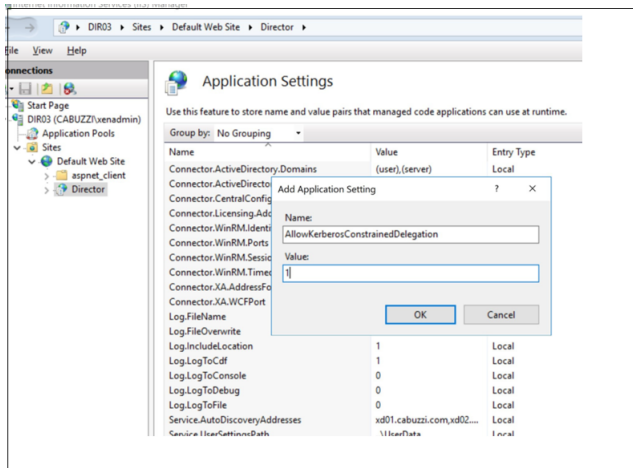

- Select **Application Pools** in the left-hand pane, then right-click the Director application pool and select **Advanced Settings**.
- Select **Identity**, click the ellipses (“...”) to enter the service account domain\logon and password credentials. Close the IIS console.

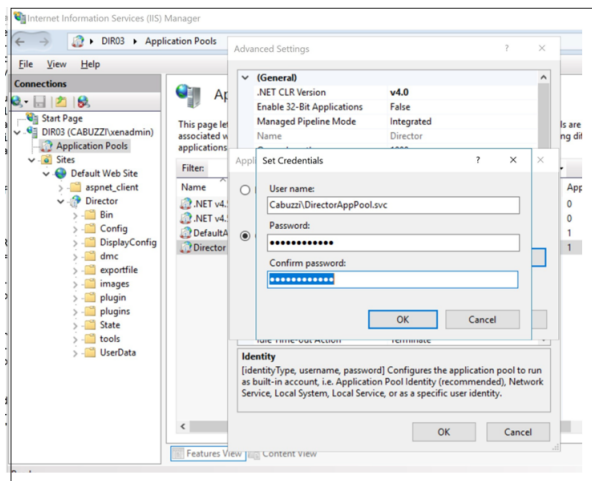

- From an elevated command prompt, change the directory to C:\Windows\System32\inetsrv and enter the following commands:

```

1 appcmd.exe set config "Default Web Site" -section:system.webServer
 /security/authentication/clientCertificateMappingAuthentication /
 enabled: " True " /commit:apphost
2
3 <!--NeedCopy-->

```

```

1 appcmd.exe set config "Default Web Site" -section:system.
 webServer/security/access /sslFlags: " Ssl, SslNegotiateCert " /
 commit:apphost
2 <!--NeedCopy-->

```



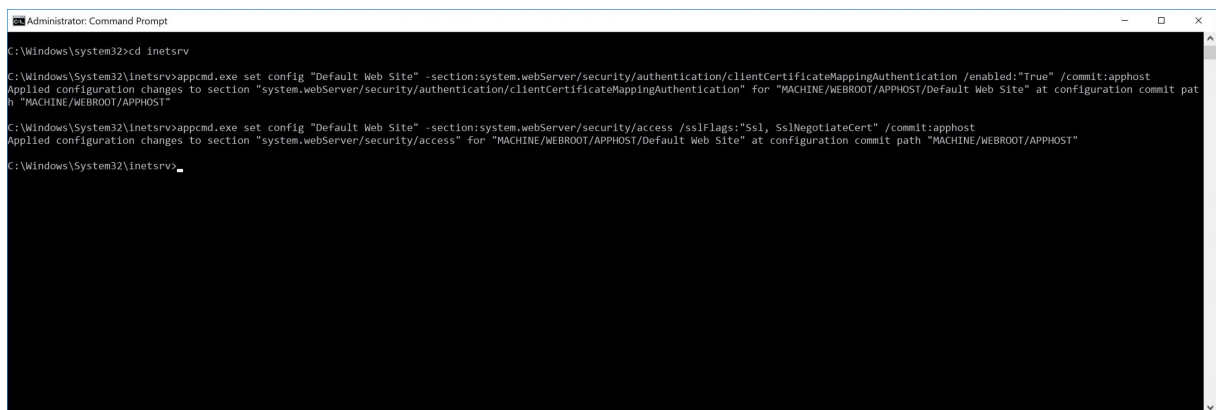

```
Administrator: Command Prompt
C:\Windows\system32>cd inetrv
C:\Windows\System32\inetrv>appcmd.exe set config "Default Web Site" -section:system.webServer/security/authentication/clientCertificateMappingAuthentication /enabled:"True" /commit:apphost
Applied configuration changes to section "system.webServer/security/authentication/clientCertificateMappingAuthentication" for "MACHINE/WEBROOT/APPHOST/Default Web Site" at configuration commit path "MACHINE/WEBROOT/APPHOST"
C:\Windows\System32\inetrv>appcmd.exe set config "Default Web Site" -section:system.webServer/security/access /sslFlags:"Ssl, SslNegotiateCert" /commit:apphost
Applied configuration changes to section "system.webServer/security/access" for "MACHINE/WEBROOT/APPHOST/Default Web Site" at configuration commit path "MACHINE/WEBROOT/APPHOST"
C:\Windows\System32\inetrv>
```

## Firefox browser configuration

To use the Firefox browser, install the PIV driver available at [OpenSC 0.17.0](#). For installation and configuration instructions, see [Installing OpenSC PKCS#11 Module in Firefox, Step by Step](#).

For information on the usage of the smart card authentication feature in Director, see the [Use Director with PIV based smart card authentication](#) section in the Director article.

## Configure network analysis

November 9, 2023

### Note:

The availability of this feature depends on your organization's license and your administrator permissions.

Director integrates with Citrix ADM to provide network analysis and performance management:

- Network analysis uses HDX Insight reports from Citrix ADM to provide an application and desktop contextual view of the network. With this feature, Director provides advanced analytics of ICA traffic in your deployment.
- Performance management provides historical retention and trend reporting. With historical retention of data versus the real-time assessment, you can create Trend reports, including capacity and health trending.

After you enable this feature in Director, HDX Insight reports provide Director with additional information:

- The Network tab in the Trends page shows latency and bandwidth effects for applications, desktops, and users across your entire deployment.

- The User Details page shows latency and bandwidth information specific to a particular user session.

**Limitations:**

- In the Trends view, HDX connection logon data isn't collected for VDAs earlier than 7. For earlier VDAs, the chart data is displayed as 0.

To enable network analysis, you must install and configure Citrix ADM in Director. Director requires Citrix ADM Version 11.1 Build 49.16 or later. MAS is a virtual appliance that run on the XenServer. Using network analysis, Director communicates and gathers the information that is related to your deployment.

For more information, see the [Citrix ADM](#) documentation.

**Note:**

Citrix NetScaler Insight Center has reached its End of Maintenance date as of 15 May 2018. See the [Citrix Product Matrix](#). Integrate Director with Citrix ADM for network analysis. To migrate your NetScaler Insight Center to Citrix ADM, see [Migrate from NetScaler Insight Center to Citrix ADM](#).

1. On the server where Director is installed, locate the DirectorConfig command line tool in C:\inetpub\wwwroot\Director\tools, and run it with parameter /confignetscaler from a command prompt.
2. When prompted, enter the Citrix ADM machine name (FQDN or IP address), the user name, password, HTTPS connection type (preferred over HTTP), and choose Citrix ADM integration.
3. To verify the changes, log off and log back on.

**Note:**

For security reasons, it is recommended to create a custom role for ADM integration with Director with sufficient permission to access HDX Insight only.

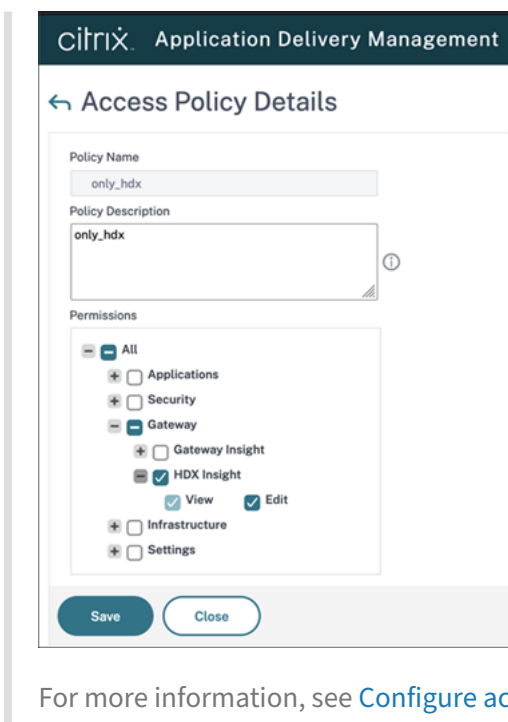

For more information, see [Configure access policies](#).

## Delegated administration and Director

March 20, 2024

Delegated administration uses three concepts: administrators, roles, and scopes. Permissions are based on an administrator's role and the scope of this role. For example, an administrator might be assigned a Help Desk administrator role where the scope involves responsibility for end-users at one site only.

For information about creating delegated administrators, see the main [delegated administration](#) article.

Administrative permissions determine the Director interface presented to administrators and the tasks they can perform. Permissions determine:

- The views the administrator can access, collectively referred to as a view.
- The desktops, machines, and sessions that the administrator can view and interact with.
- The commands the administrator can perform, such as shadowing a user's session or enabling maintenance mode.

The built-in roles and permissions also determine how administrators use Director:

---

| Administrator Role            | Permissions in Director                                                                                                                                                                                                                                                                                                                                                                                                             |
|-------------------------------|-------------------------------------------------------------------------------------------------------------------------------------------------------------------------------------------------------------------------------------------------------------------------------------------------------------------------------------------------------------------------------------------------------------------------------------|
| Full Administrator            | Full access to all views and can perform all commands, including shadowing a user's session, enabling maintenance mode, and exporting trends data.                                                                                                                                                                                                                                                                                  |
| Delivery group Administrator  | Full access to all views and can perform all commands, including shadowing a user's session, power management and session management, enabling maintenance mode, and exporting trends data.                                                                                                                                                                                                                                         |
| Read Only Administrator       | Can access all views and see all objects in specified scopes and global information. Can download reports from HDX channels and can export Trends data using the Export option in the Trends view. Cannot perform any other commands or change anything in the views.                                                                                                                                                               |
| Help Desk Administrator       | Can access only the Help Desk and User Details views and can view only objects that the administrator is delegated to manage. Can shadow a user's session and perform commands for that user. Can perform maintenance mode operations. Can use power control options for Single-session OS Machines. Cannot access the Dashboard, Trends, Alerts, or Filters views. Cannot use power control options for Multi-session OS machines. |
| Machine catalog administrator | Can access only the Machine Details page (Machine-based search).                                                                                                                                                                                                                                                                                                                                                                    |
| Host Administrator            | No access. This administrator is not supported for Director and cannot view data.                                                                                                                                                                                                                                                                                                                                                   |

---

### **Configure custom roles for Director administrators**

In Studio, you can also configure Director-specific, custom roles to more closely match the requirements of your organization and delegate permissions more flexibly. For example, you can restrict the built-in Help Desk administrator role so that this administrator cannot log off sessions.

If you create a custom role with Director permissions, you must also give that role other generic per-

missions:

- Delivery Controller permission to log on to Director - at least read only access in Administrator node
- Permissions to delivery groups to view the data related to those delivery groups in Director - at least read only access

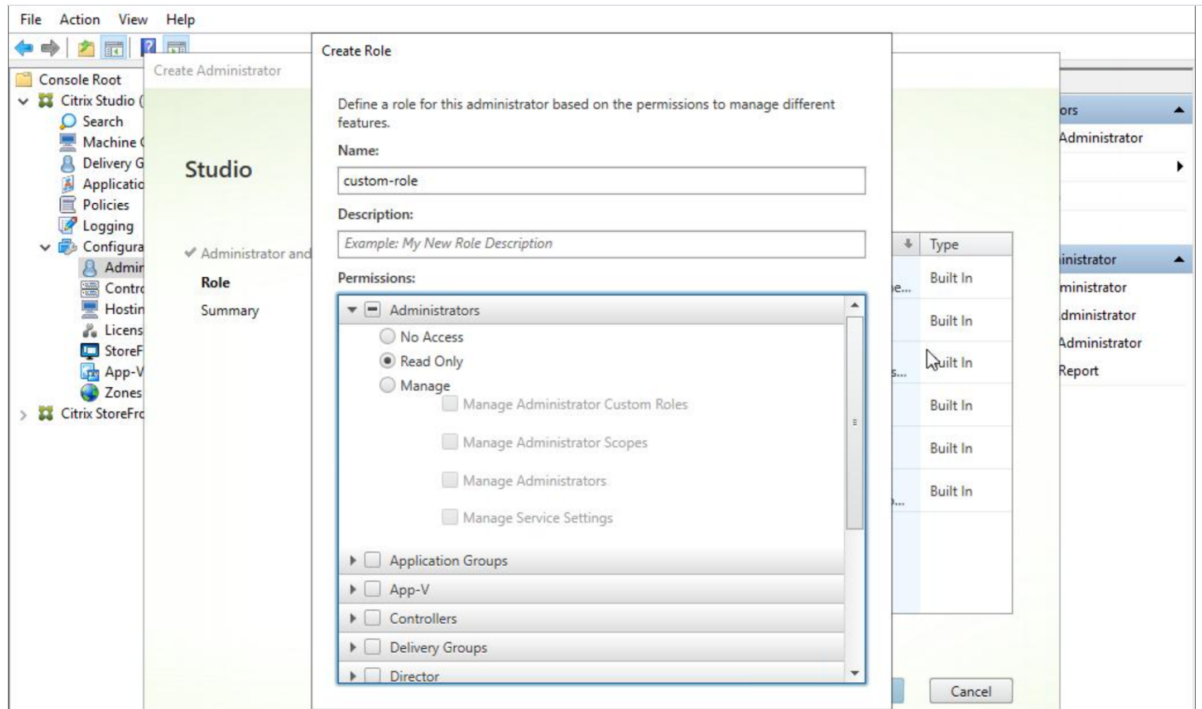

Alternatively, you can create a custom role by copying an existing role and include extra permissions for different views. For example, you can copy the Help Desk role and include permissions to view the Dashboard or Filters pages.

Select the Director permissions for the custom role, which include:

- Perform Kill Application running on a machine
- Perform Kill Process running on a machine
- Perform Remote Assistance on a machine
- Reset user profiles
- View Client Details page
- View Dashboard page
- View Filters page
- View Machine Details page
- View Trends page
- View User Details page

In this example, Shadowing (Perform Remote Assistance on a machine) is turned off.

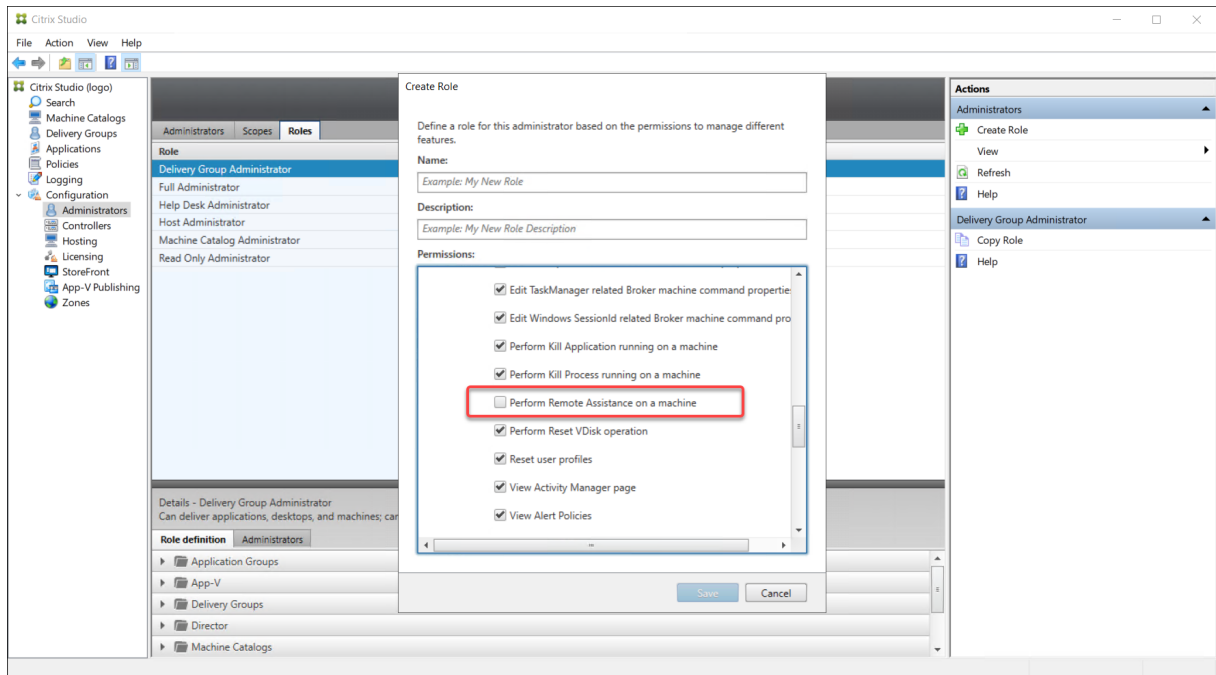

A permission can have dependencies on other permissions to become applicable on the UI. For example, selecting the **Perform Kill Application running on a machine** permission enables the **End Application** functionality only in those panels to which the role has permission. You can select the following panel permissions:

- View Filters page
- View User Details page
- View Machine Details page
- View Client Details page

In addition, from the list of permissions for other components, consider these permissions from delivery groups:

- Enable/disable maintenance mode of a machine using delivery group membership.
- Perform power operations on Windows Desktop machines using delivery group membership.
- Perform session management on machines using delivery group membership.

## Secure Director deployment

January 11, 2022

This article highlights areas that might have an impact on system security when deploying and configuring Director.

## **Configure Microsoft Internet Information Services (IIS)**

You can configure Director with a restricted IIS configuration.

### **Application Pool recycling limits**

You can set the following Application Pool recycling limits:

- Virtual Memory Limit: 4,294,967,295
- Private Memory Limit: The size of the physical memory of the StoreFront server
- Request Limit: 4,000,000,000

### **File name extensions**

You can disallow unlisted file name extensions.

Director requires these file name extensions in Request Filtering:

- .aspx
- .css
- .html
- .js
- .png
- .svc
- .png
- .json
- .woff
- .woff2
- .ttf

Director requires the following HTTP verbs in Request Filtering. You can disallow unlisted verbs.

- GET
- POST
- HEAD

Director does not require:

- ISAPI filters
- ISAPI extensions
- CGI programs
- FastCGI programs

**Important:**

- Director requires Full Trust. Do not set the global .NET trust level to High or lower.
- Director maintains a separate application pool. To modify the Director settings, select the Director site and modify.

## Configure user rights

When Director is installed, its application pools are granted the following:

- **Log on as a service** logon right
- **Adjust memory quotas for a process, Generate security audits, and Replace a process level token** privileges

The rights and privileges mentioned are normal installation behavior when application pools are created.

You do not need to change these user rights. These privileges are not used by Director and are automatically disabled.

## Director communications

In a production environment, use the Internet Protocol security (IPsec) or HTTPS protocols to secure the data passing between Director and your servers.

IPsec is a set of standard extensions to the Internet Protocol that provides authenticated and encrypted communications with data integrity and replay protection. Since IPsec is a network-layer protocol set, higher level protocols can use it without modification. HTTPS uses the Transport Layer Security (TLS) protocols to provide strong data encryption.

**Note:**

- Citrix strongly recommends that you restrict access to Director console within the intranet network.
- Citrix strongly recommends that you do not enable unsecured connections to Director in a production environment.
- Secure communications from Director require configuration for each connection separately.
- The SSL protocol is not recommended. Use the more secure TLS protocol instead.
- Secure your communications with Citrix ADC using TLS, not IPsec.

To secure communications between Director and Citrix Virtual Apps and Desktops servers (for monitoring and reports), refer to [Data Access Security](#).



To secure communications between Director and Citrix ADC (for Citrix Insight), refer to [Configure network analysis](#).

To secure communications between Director and License server, refer to [Secure the License Administration Console](#).

### **Director security separation**

You can deploy any web applications in the same web domain (domain name and port) as Director. However, any security risks in those web applications can potentially reduce the security of your Director deployment. Where a greater degree of security separation is required, Citrix recommends that you deploy Director in a separate web domain.

## **Configuring on-premises sites with Citrix Analytics for Performance**

March 27, 2024

Citrix Analytics for Performance (Performance Analytics) is the comprehensive performance monitoring solution from the Citrix Analytics Cloud Service. Performance analytics provides advanced insights and analytics built on performance metrics. Performance Analytics helps you monitor and view the usage and performance metrics of one or more Citrix Virtual Apps and Desktops sites in your organization.

For more information about Performance Analytics, see the [Performance Analytics article](#).

You can send performance data from your site to Citrix Analytics for Performance on Citrix Cloud to leverage its advanced performance analytics capabilities. To view and use Performance Analytics, you must first configure your on-premises sites with Citrix Analytics for Performance from the **Analytics** tab in **Director**.

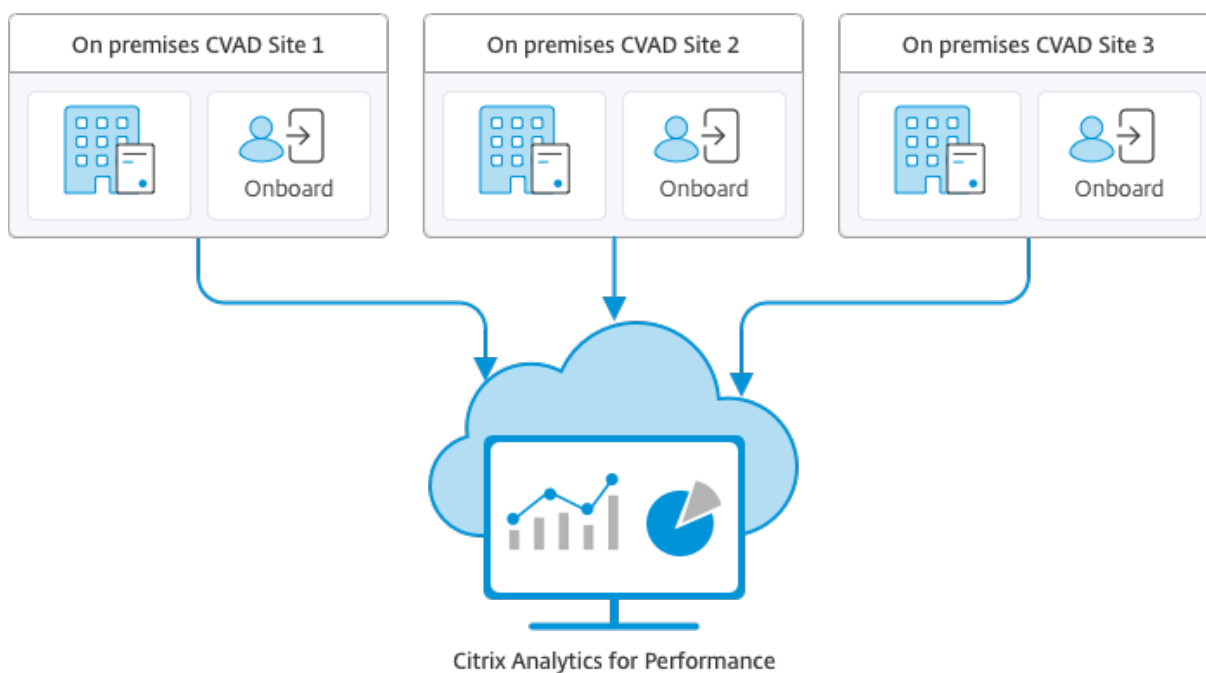

Performance Analytics accesses data in a secure manner and no data is transferred from Citrix Cloud to the on-premises environment.

## Prerequisites

To configure Citrix Analytics for Performance from Director, no new components need to be installed. Ensure that the following requirements are met:

- Your Delivery Controller and Director are on version 1912 CU2 or later. For more information, see [Feature compatibility matrix](#).

### Note:

- Configuring your on-premises site with Citrix Analytics for Performance from Director might fail if the Delivery Controller is running a Microsoft .NET Framework version earlier than 4.8. As a workaround, upgrade the .NET Framework in your Delivery Controller to version 4.8. [LCM-9255](#).
- When you configure your on-premises site running Citrix Virtual Apps and Desktops version 2012 with Citrix Analytics for Performance from Director, the configuration might fail after a couple of hours or after a restart of the Citrix Monitor Service in the Delivery Controller. The Analytics tab displays a Not Connected status in this case. As a workaround, create an Encryption folder in the registry on the Delivery Controller, Location: HKEY\_LOCAL\_MACHINE\Software\Citrix\XDservices\Monitor, Folder Name: Encryption. Ensure that the CitrixMonitor account has Full Control Access on the Encryption

folder. Restart the Citrix Monitor Service.[DIR-14324](#).

- Access to the **Analytics** tab to perform this configuration is available for full administrators only.
- For Performance Analytics to access performance metrics, outbound internet access is available on all Delivery Controllers and the machines on which Director is installed. Specifically, ensure accessibility to the following URLs:

- Citrix Key Registration: [https://\\*.citrixnetworkapi.net/](https://*.citrixnetworkapi.net/)
- Citrix Cloud: [https://\\*.citrixworkspacesapi.net/](https://*.citrixworkspacesapi.net/)
- Citrix Analytics: [https://\\*.cloud.com/](https://*.cloud.com/)
- Microsoft Azure: [https://\\*.windows.net/](https://*.windows.net/)

In case, Delivery Controllers and Director machines are within an intranet and outbound internet access is via a proxy server, ensure the following:

- The proxy server must allow the preceding list of URLs.
- Add the following configuration in the Director web.config and citrix.monitor.exe.config files. Ensure that you add this configuration within the **configuration** tags:

```
1 <system.net>
2 <defaultProxy>
3 <proxy usesystemdefault = "false" proxyaddress = "http
4 ://<your_proxyserver_address>:80" bypassonlocal = "
5 true" />
6 </defaultProxy>
7 </system.net>
```

- The Director web.config is located at `C:\inetpub\wwwroot\Director\web.config` on the machine where Director is installed.
- The citrix.monitor.exe.config is located at `C:\Program Files\Citrix\Monitor\Service\Citrix.Monitor.exe.Config` on the machine where the Delivery Controller is installed.

This setting is provided by Microsoft on IIS. For more information, see <https://docs.microsoft.com/en-us/dotnet/framework/network-programming/proxy-configuration>.

The **defaultproxy** field in the config file controls the outbound access of Director and Monitor Service. Configuration and communication with Performance Analytics requires the **default-proxy** field to be set to **true**. It is possible that the policies in effect set this field to false. In this case, you must manually set the field to true. Take a backup of the config files before you make the changes. Restart the Monitoring service on the Delivery Controller for the changes to be affected.

- You have an active Citrix Cloud entitlement for Citrix Analytics for Performance.

- Your Citrix Cloud account is an Administrator account with rights to the Product Registration Experience. For more information about administrator permissions, see [Modify Administrator Permissions](#).

## Configuration steps

After you have verified the prerequisites, do the following:

1. Sign in to Director as a full administrator and select the site which you want to configure with Performance Analytics. The Director Dashboard page appears.

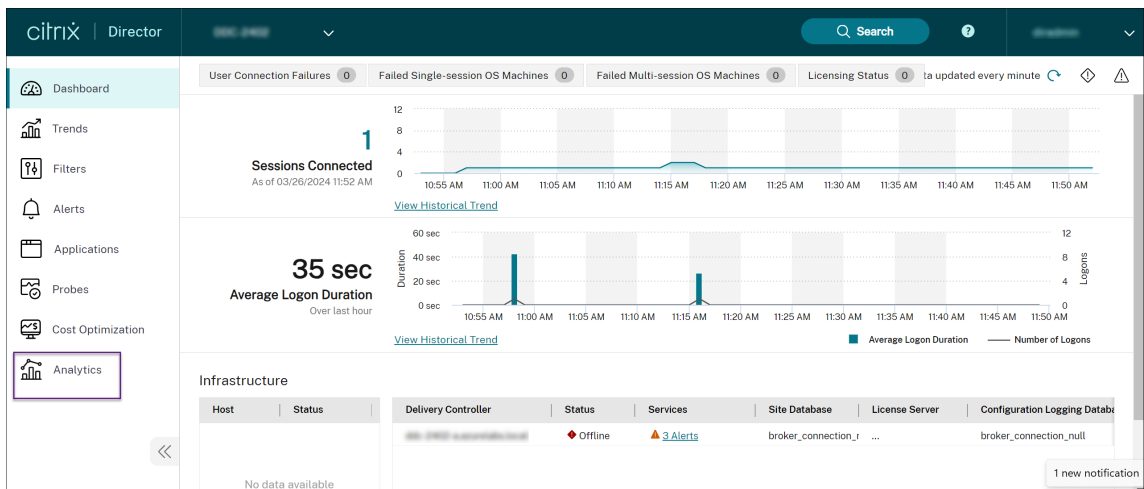

2. Click the **Analytics** tab. The **Configure Citrix Analytics** page appears.

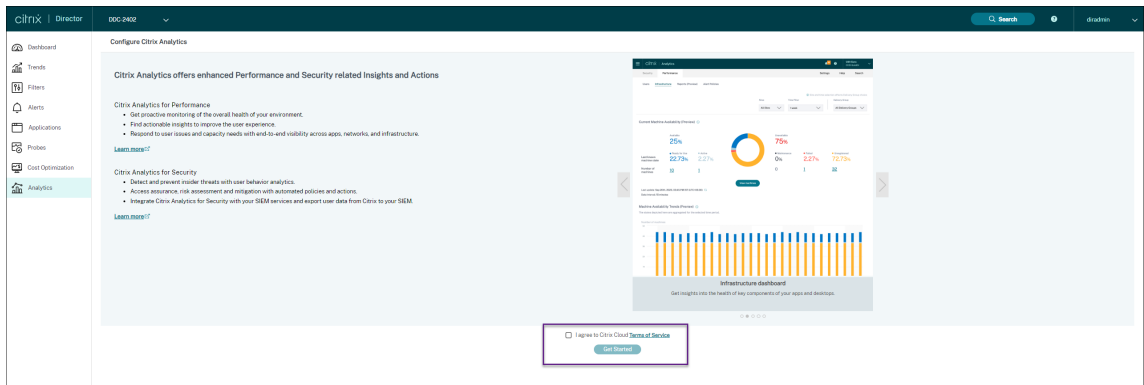

3. Review the steps, select the terms of service, and then click **Get Started**. The **Site Details** page appears.

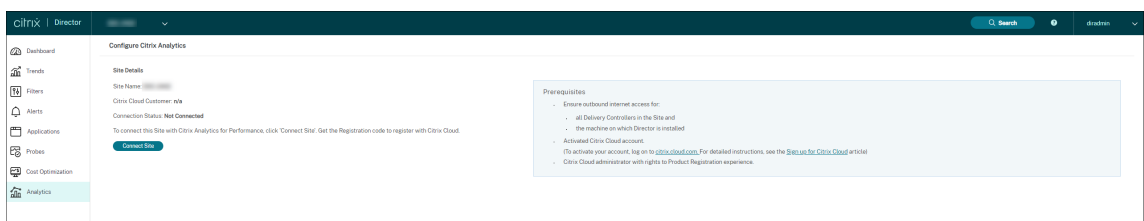

4. Review the prerequisites and ensure that they are met. Review the site details.
5. Click **Connect Site** to start the configuration process.

A unique 8-digit registration code is generated to be used to register this site with Citrix Cloud.

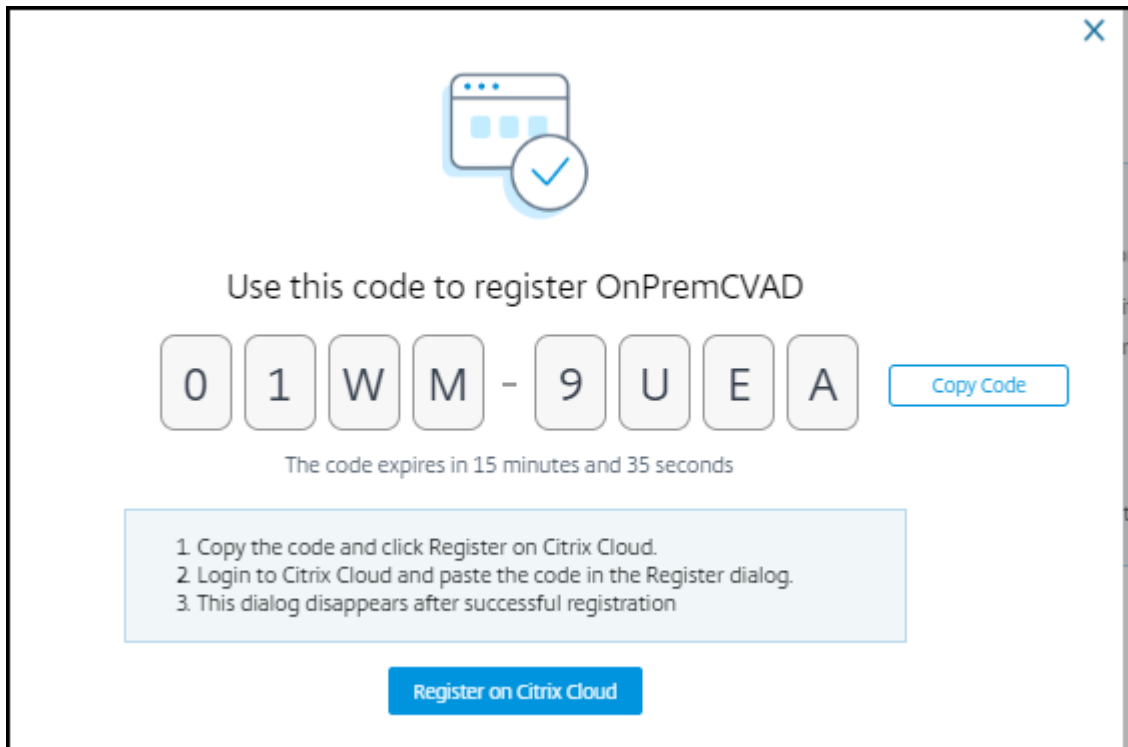

6. Click **Copy Code** to copy the code and then click **Register on Citrix Cloud**. You are redirected to the registration URL in Citrix Cloud.
7. Sign in with your Citrix Cloud credentials and select your customer.
8. Paste the copied registration code in the Product Registrations page in Citrix Cloud. Click **Continue** to register. Review the registration details and click **Register**.

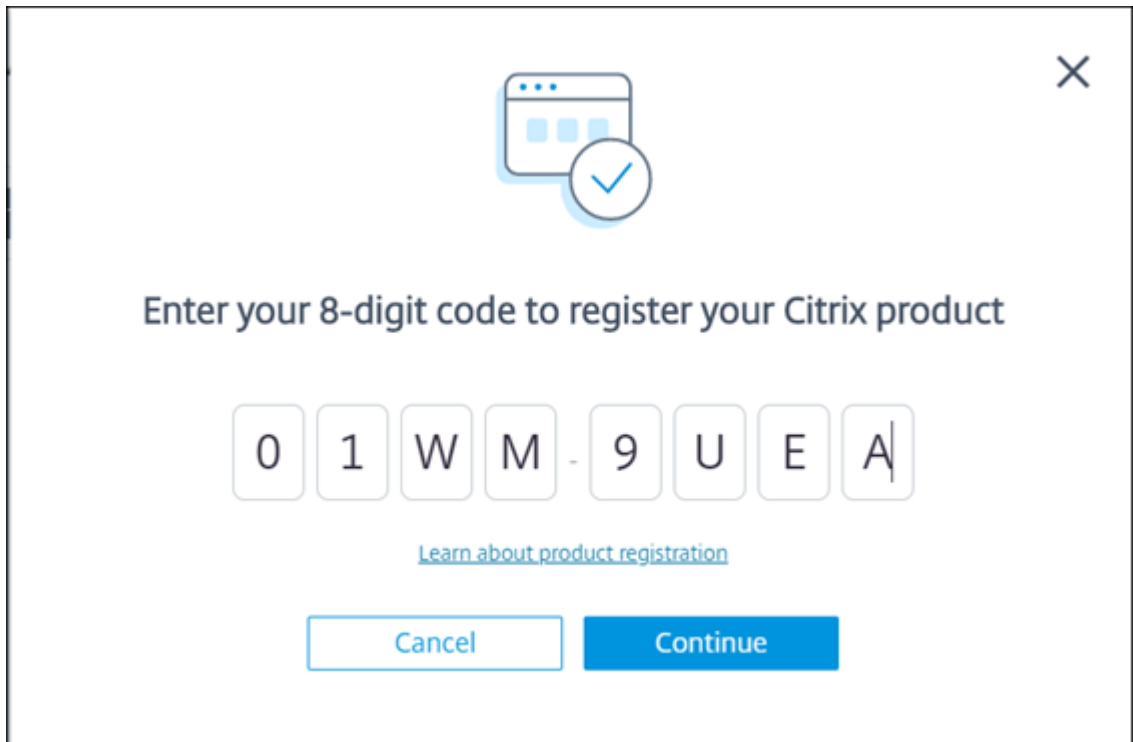

Your on-premises site registers with Citrix Cloud.

9. From **Director**, click **Go to Analytics** on the **Analytics** tab.

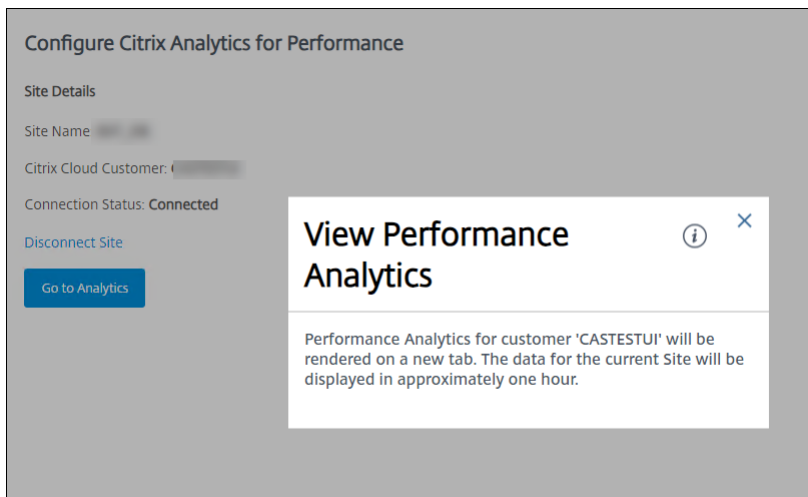

Performance Analytics opens on a new tab on your browser.

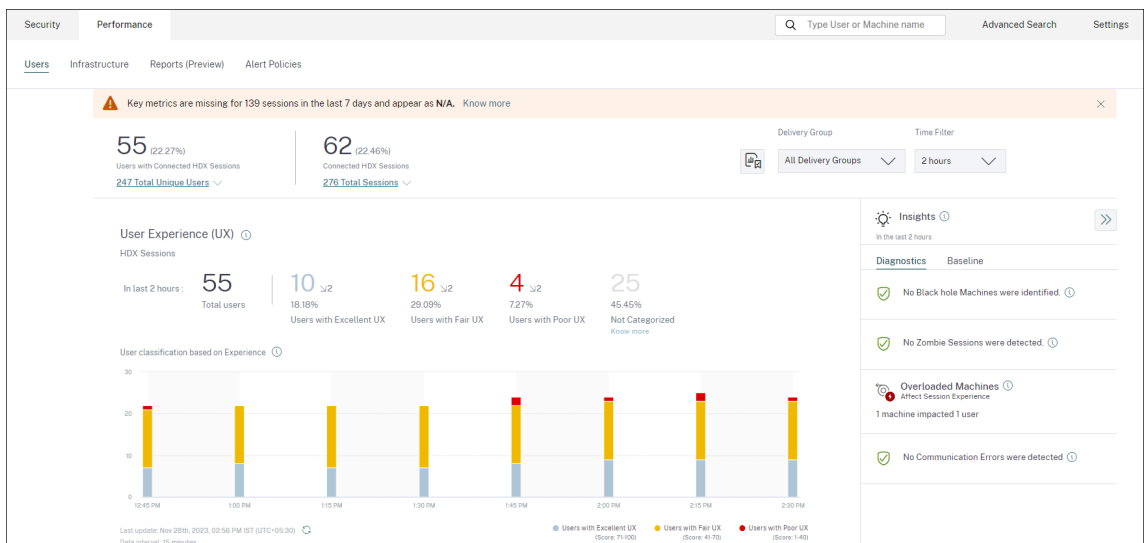

If your Citrix Cloud session has expired, you might be redirected to the Citrix.com or My Citrix account logon page.

- To register multiple sites with Performance Analytics, repeat the preceding configuration steps for each site from Director. Metrics for all configured sites are displayed on the Performance Analytics dashboard.

In case you have more than one Director instance running per site, configure from any one Director instance. All other Director instances connected to the site are updated at the next refresh after the configuration process.

- To disconnect your site from Citrix Cloud, click **Disconnect Site**. This option deletes the existing configuration.

**Notes:**

The first time you configure a site, events from the site might take some time (approximately an hour) to be processed; causing a delay in the display of metrics on the Performance Analytics dashboard. Thereafter, events refresh at regular intervals.

Upon disconnect, data transmission from the old account continues for some time until the events from the new account are transmitted. For approximately one hour after data transmission stops, analytics related to the old account remain displayed on the Performance Analytics Dashboard.

Upon expiry of entitlement to the Citrix Analytics service, it takes up to a day to stop sending the site metrics to Performance Analytics.

## Site Analytics

December 7, 2023

Using Director, you can monitor the health your deployments. You can troubleshoot performance issues by searching for a user, endpoint, or machine across all onboarded sites.

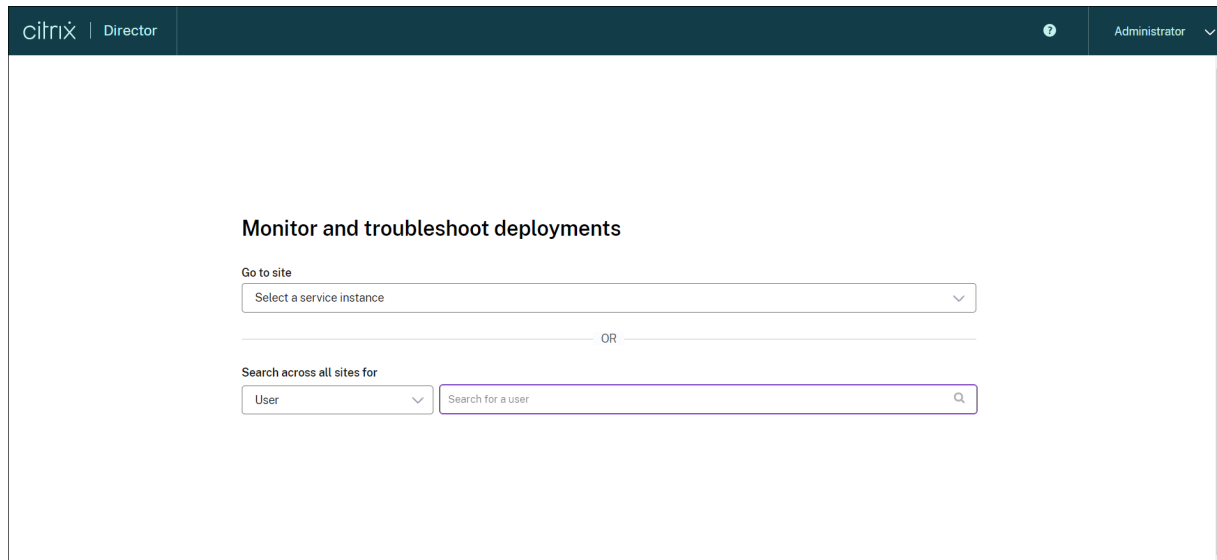

With full administrator permission, when you open Director, the Dashboard provides a centralized location to monitor the health and usage of a site.

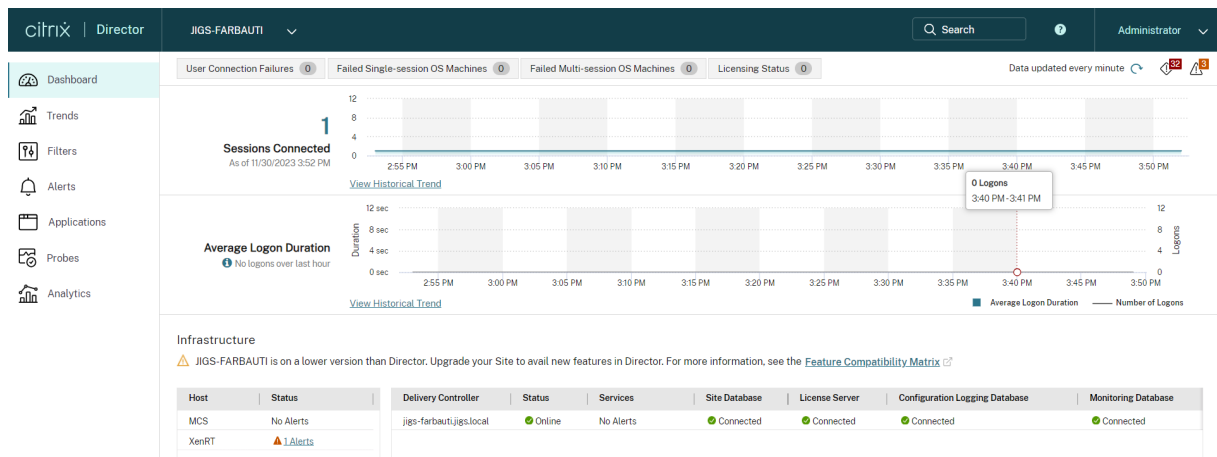

If there are currently no failures and no failures have occurred in the past 60 minutes, the panels stay collapsed. When there are failures, the specific failure panel automatically appears.

**Note:**



Depending on your organization's license and your Administrator privileges, some options or features might not be available.

## Panels on the Director Dashboard

### User Connection Failures

Connection failures over the last 60 minutes. Click the categories next to the total number to view metrics for that type of failure. In the adjacent table that number is broken out by delivery groups. Connection failures include failures caused by application limits being reached. For more information on application limits, see [Applications](#).

### Failed Single-session OS Machines or Failed Multi-session OS Machines

Total failures in the last 60 minutes broken out by delivery groups. Failures broken out by types, including failed to start, stuck on boot, and unregistered. For Multi-session OS machines, failures also include machines reaching maximum load.

### Licensing Status

License Server alerts display alerts sent by the License Server and the actions required to resolve the alerts. Requires License Server Version 11.12.1 or later. Delivery Controller alerts display the details of the licensing state as seen by the Controller and are sent by the Controller. Requires Controller for XenApp 7.6 or XenDesktop 7.6 or later. You can set the threshold for alerts in Studio. Licensing status displayed in **Delivery Controllers > Details > Product Editions > PLT** indicates **Premium** and not **Platinum**.

### Grace State

Director displays one of the following grace states. This information is fetched from the Delivery Controller.

1. **Not Active:** Not in any type of grace period. Normal licensing limits apply.
2. **Out of Box Grace:** 10 connections for the first 30 days after a new installation when pointing to a license server with no licenses.
3. **Supplemental Grace:** When all licenses are consumed, a 15 day grace period is provided for business continuity until new licenses are added, or consumption is reduced. Unlimited connections are allowed during the supplemental grace period. Users are not affected. Warnings shown in Director cannot be dismissed until the supplemental grace period expires or is reset.

4. **Emergency Grace:** Comes into effect when the license server is unreachable or the license information cannot be fetched while brokering a connection. Emergency grace is valid for 30 days. Users are not affected. Errors shown in Director cannot be dismissed until the license server is reachable.
5. **Grace Expired:** Emergency Grace or the supplemental grace period has expired.

For more information, see [License overdraft](#) and [Supplemental grace period](#).

### Sessions Connected

Connected sessions across all delivery groups for the last 60 minutes.

### Average Logon Duration

Logon data for the last 60 minutes. The large number on the left is the average logon duration across the hour. Logon data for VDAs earlier than XenDesktop 7.0 is not included in this average. For more information, see [Diagnose user logon issues](#).

### Infrastructure

Lists your site's infrastructure - hosts and Controllers. For infrastructure from XenServer or VMware, you can view performance alerts. For example, you can configure XenCenter to generate performance alerts when CPU, network I/O, or disk I/O usage go over a specified threshold on a managed server or virtual machine. By default, the alert repeat interval is 60 minutes, but you can configure this as well. For details, see the XenCenter Performance Alerts section in the [XenServer product documentation](#).

#### Note:

If no icon appears for a particular metric, this indicates that this metric is not supported by the type of host you are using. For example, no health information is available for System Center Virtual Machine Manager (SCVMM) hosts, AWS and CloudStack.

Continue to troubleshoot issues using these options (which are documented in the following sections):

- [Control user machine power](#)
- [Prevent connections to machines](#)

## Monitor sessions

If a session becomes disconnected, it is still active and its applications continue to run, but the user device is no longer communicating with the server.

| Action                                                                 | Description                                                                                                                                                                                                                                                                                                                                             |
|------------------------------------------------------------------------|---------------------------------------------------------------------------------------------------------------------------------------------------------------------------------------------------------------------------------------------------------------------------------------------------------------------------------------------------------|
| View a user's currently connected machine or session                   | From the Activity Manager and User Details views, view the user's currently connected machine or session and a list of all machines and sessions to which this user has access. To access this list, click the session switcher icon in the user title bar. For more information, see <a href="#">Restore sessions</a> .                                |
| View the total number of connected sessions across all delivery groups | From the Dashboard, in the <b>Sessions Connected</b> pane, view the total number of connected sessions across all delivery groups for the last 60 minutes. Then click the large total number, which opens the Filters view, where you can display graphical session data based on selected delivery groups and ranges and usage across delivery groups. |
| End idle sessions                                                      | The Sessions Filters view displays data related to all active sessions. Filter the sessions based on Associated User, delivery group, Session State, and Idle Time greater than a threshold time period. From the filtered list, select sessions to log off or disconnect. For more information, see <a href="#">Troubleshoot applications</a> .        |
| View data over a longer period of time                                 | On the Trends view, select the <b>Sessions</b> tab to drill down to more specific usage data for connected and disconnected sessions over a longer period of time (that is, session totals from earlier than the last 60 minutes). To view this information, click <b>View historical trends</b> .                                                      |

### Note:

If the user device is running a legacy Virtual Delivery Agent (VDA), such as a VDA earlier than version 7, or a Linux VDA, Director cannot display complete information about the session. Instead,

it displays a message that the information is not available.

**Desktop Assignment Rules limitation:**

Web Studio allows assignment of multiple Desktop Assignment Rules (DAR) for different users or user groups to a single VDA in the delivery group. StoreFront displays the assigned desktop with the corresponding **Display Name** as per the DAR for the logged in user. However, Director does not support DARs and displays the assigned desktop using the delivery group name regardless of the logged in user. As a result, you cannot map a specific desktop to a machine in Director.

You can map the assigned desktop displayed in StoreFront to the delivery group name displayed in Director using the following PowerShell command:

```
1 Get-BrokerDesktopGroup | Where-Object {
2 \$_.Uid -eq \((Get-BrokerAssignmentPolicyRule | Where-Object {
3 \$_.PublishedName -eq "\"<Name on StoreFront\>\" }
4 }).DesktopGroupUid }
5 | Select-Object -Property Name, Uid
```

**Session transport protocol**

View the transport protocol in use for the HDX connection type for the current session in the **Session Details** panel. This information is available for sessions launched on VDAs Version 7.13 or later.

### Session Details

Session Control ▾ Shadow Send Message

|                   |              |
|-------------------|--------------|
| ID                | 2            |
| Session State     | Disconnected |
| Application State | Desktop      |
| Anonymous         | No           |
| Time in State     | 1 mins       |

---

|                              |            |
|------------------------------|------------|
| Endpoint IP                  | [REDACTED] |
| Endpoint Name                | [REDACTED] |
| Connection Type              | RDP        |
| Protocol                     | n/a        |
| Citrix Workspace App Version | n/a        |

---

|               |                                |
|---------------|--------------------------------|
| ICA RTT       | n/a <a href="#">View Trend</a> |
| ICA Latency   | n/a <a href="#">View Trend</a> |
| Launched Via  | n/a                            |
| Connected Via | [REDACTED]                     |

**Policies** Hosted Applications SmartAccess Filters

Process Monitoring

ICA RTT IDLE

- For **HDX** Connection type,
  - The Protocol is displayed as **UDP**, if EDT is used for the HDX connection.
  - The Protocol is displayed as **TCP**, if TCP is used for the HDX connection.
- For **RDP** Connection type, the Protocol is displayed as **n/a**.

When adaptive transport is configured, the session transport protocol dynamically switches between EDT (over UDP) and TCP, based on the network conditions. If the HDX session cannot be established using EDT, it falls back to the TCP protocol.

For more information about adaptive transport configuration, see [Adaptive Transport](#).

## Export reports

You can export trends data to generate regular usage and capacity management reports. Export supports PDF, Excel, and CSV report formats. Reports in PDF and Excel formats contain trends represented as graphs and tables. CSV format reports contain tabular data that can be processed to generate views or can be archived.

To export a report:

1. Go to the **Trends** tab.
2. Set filter criteria and time period and click **Apply**. The trend graph and table are populated with data.
3. Click **Export** and enter name and format of the report.

Director generates the report based on the filter criteria you select. If you change the filter criteria, click **Apply** before you click **Export**.

### Note:

Export of a large amount of data causes a significant increase in memory and CPU consumption on the Director server, the Delivery Controller, and the SQL servers. The supported number of concurrent export operations and the amount of data that can be exported is set to default limits to achieve optimal export performance.

## Supported export limits

Exported PDF and Excel reports contain complete graphical charts for the selected filter criteria. However, tabular data in all report formats is truncated beyond the default limits on the number of rows or records in the table. The default number of records supported is defined based on the report format.

You can change the default limit by configuring the Director Application Settings in Internet Information Services (IIS).

| Report format | Default number of records supported         | Fields in Director Application Settings | Max number of records supported |
|---------------|---------------------------------------------|-----------------------------------------|---------------------------------|
| PDF           | 500                                         | UI.ExportPdfDrilldownLimit              | 500                             |
| Excel         | 100,000                                     | UI.ExportExcelDrilldownLimit            | 100,000                         |
| CSV           | 100,000 (10,000,000 in <b>Sessions</b> tab) | UI.ExportCsvDrilldownLimit              | 100,000                         |

To change the limit of the number of records you can export:

1. Open the IIS Manager console.
2. Go to the Director website under the Default website.
3. Double-click **Application Settings**.
4. Edit or add a setting for the fields `UI.ExportPdfDrilldownLimit`, `UI.ExportExcelDrilldownLimit`, or `UI.ExportCsvDrilldownLimit` as required.

Adding these field values in Application Settings overrides the default values.

**Warning:**

Setting field values greater than the max number of records supported can impact the performance of Export and is not supported.

## Error Handling

This section gives you information on dealing with errors that you might encounter during Export operation.

- **Director has timed out**

This error can occur due to network issues or high resource usage on the Director server or with the Monitor Service.

The default timeout duration is 100 seconds. To increase the timeout duration of the Director Service, set the value of **Connector.DataServiceContext.Timeout field in** Director Application Settings in Internet Information Services (IIS):

1. Open the IIS Manager console.
2. Go to the Director website under the Default website.
3. Double-click **Application Settings**.
4. Edit the value **Connector.DataServiceContext.Timeout**.

- **Monitor has timed out**

This error can occur due to network issues or high resource usage with the Monitor Service or on the SQL server.

To increase the timeout duration of the Monitor Service, run the following PowerShell commands on the Delivery Controller:

```
1 asnp Citrix.*
2 Get-MonitorConfiguration
3 Set-MonitorConfiguration -MonitorQueryTimeoutSeconds <timeout value>
```

- **Max concurrent Export or Preview operations ongoing**

Director supports one instance of Export or Preview. If you get the **Max concurrent Export or Preview operations ongoing** error, try the next Export operation again later.

It is possible to increase the number of concurrent Export or Preview operations, however this can impact the performance of Director and is not supported:

1. Open the IIS Manager console.
2. Go to the Director website under the Default website.
3. Double-click **Application Settings**.
4. Edit the value **UI.ConcurrentExportLimit**.

- **Insufficient disk space in Director**

Each Export operation requires a maximum of 2 GB hard disk space in the Windows Temp folder. Retry Export after clearing space or adding more hard disk space on the Director server.

## Monitor hotfixes

To view the hotfixes installed on a specific machine VDA (physical or VM), choose the **Machine Details** view.

## Control user machine power states

To control the state of the machines that you select in Director, use the Power Control options. These options are available for Single-session OS machines, but might not be available for Multi-session OS machines.

**Note:**

This functionality is not available for physical machines or machines using Remote PC Access.

---

| Command        | Function                                                                                                                                                                                                                                   |
|----------------|--------------------------------------------------------------------------------------------------------------------------------------------------------------------------------------------------------------------------------------------|
| <b>Restart</b> | Performs an orderly (soft) shutdown of the VM and all running processes are halted individually before restarting the VM. For example, select machines that appear in Director as “failed to start,” and use this command to restart them. |



| Command               | Function                                                                                                                                                                                                                                                         |
|-----------------------|------------------------------------------------------------------------------------------------------------------------------------------------------------------------------------------------------------------------------------------------------------------|
| <b>Force Restart</b>  | Restarts the VM without first performing any shut-down procedure. This command works in the same way as unplugging a physical server and then plugging it back in and turning it back on.                                                                        |
| <b>Shut Down</b>      | Performs an orderly (soft) shutdown of the VM. All running processes are halted individually.                                                                                                                                                                    |
| <b>Force Shutdown</b> | Shuts down the VM without first performing any shut-down procedure. This command works in the same way as unplugging a physical server. It might not always shut down all running processes, and you risk losing data if you shut down a VM in this way.         |
| <b>Suspend</b>        | Suspends a running VM in its current state and stores that state in a file on the default storage repository. This option allows you to shut down the VM's host server and later, after rebooting it, resume the VM, returning it to its original running state. |
| <b>Resume</b>         | Resumes a suspended VM and restores its original running state.                                                                                                                                                                                                  |
| <b>Start</b>          | Starts a VM when it is off (also called a cold start).                                                                                                                                                                                                           |

---

If power control actions fail, hover the mouse over the alert, and a pop-up message appears with details about the failure.

## Prevent connections to machines

Use maintenance mode to prevent new connections temporarily while the appropriate administrator performs maintenance tasks on the image.

When you enable maintenance mode on machines, no new connections are allowed until you disable it. If users are currently logged on, maintenance mode takes effect as soon as all users are logged off. For users who do not log off, send a message informing them that machines will be shut down at a certain time, and use the power controls to force the machines to shut down.

1. Select the machine, such as from the User Details view, or a group of machines in the Filters view.

2. Select **Maintenance Mode**, and turn on the option.

If a user tries to connect to an assigned desktop while it is in maintenance mode, a message appears indicating that the desktop is unavailable. No new connections can be made until you disable maintenance mode.

## Application Analytics

The **Applications** tab displays application-based analytics in a single, consolidated view to help analyze and manage application performance efficiently. You can gain valuable insight into the health and usage information of all applications published on the site. It shows metrics such as the probe results, number of instances per application, and faults and errors associated with the published applications. For more information, see the [Application Analytics](#) section in **Troubleshooting Applications**.

## Alerts and notifications

December 1, 2023

Alerts are displayed in Director on the dashboard and other high level views with warning and critical alert symbols. Alerts are available for **Premium** licensed sites. Alerts update automatically every minute; you can also update alerts on demand.

The screenshot shows the Citrix Director interface with the Alerts panel open. The Alerts panel displays a list of critical alerts (red diamonds) for the site JIGS-FARBAUTI. The alerts include:

- Memory (%) >= 2 JIGS-TSUDA-1-FARBAUTI
- Memory (%) >= 2 JIGSUIGS-TS-1-FARB
- Memory (%) >= 2 JIGS-VDA-1-FARBAUTI
- CPU (%) >= 2 JIGS-VDA-1-FARBAUTI
- CPU (%) >= 2 JIGS-FARBAUTI
- CPU (%) >= 2 JIGSUIGS-TS-1-FARB
- CPU (%) >= 2 JIGS-TSUDA-1-FARBAUTI
- Network usage alert has been triggered on the Hypervisor ho... XenRT - R2A12-C08-B03
- Network usage alert has been triggered on the Hypervisor ho...

The Alerts panel also shows a summary of (32) Critical and (3) Warning alerts. The background shows the main dashboard with metrics for Sessions Connected and Average Logon Duration.

A warning alert (amber triangle) indicates that the warning threshold of a condition has been reached or exceeded.

A critical alert (red circle) shows that the critical threshold of a condition has been reached or exceeded.

You can view more detailed information on alerts by selecting an alert from the sidebar, clicking the **Go to Alerts** link at the bottom of the sidebar or by selecting **Alerts** from the top of the Director page.

In the Alerts view, you can filter and export alerts. For example, Failed Multi-session OS machines for a specific Delivery Group over the last month, or all alerts for a specific user. For more information, see [Export reports](#).

| Alert Time         | Status   | Alert Policy Name          | Scope                         | Source                | Category                | Description                  |
|--------------------|----------|----------------------------|-------------------------------|-----------------------|-------------------------|------------------------------|
| 11/30/2023 3:56 PM | Warning  | DG Email Policy            | JIGS-TSVDA-1-FARBAUTI, J...   | JIGS-TSVDA-1-FARBAUTI | Peak Connected Sessions | Peak Connected Sessions ...  |
| 11/30/2023 3:56 PM | Warning  | Multi Session OS Email     | All Server OS Machines in ... | JIGS\JIGS-TS-1-FARB   | Peak Connected Sessions | Peak Connected Sessions ...  |
| 11/30/2023 3:53 PM | Critical | DG Email Policy            | JIGS-TSVDA-1-FARBAUTI, J...   | JIGS-TSVDA-1-FARBAUTI | Memory (%)              | Memory (%) >= 2              |
| 11/30/2023 3:53 PM | Critical | Multi Session OS Email     | All Server OS Machines in ... | JIGS\JIGS-TS-1-FARB   | Memory (%)              | Memory (%) >= 2              |
| 11/30/2023 3:52 PM | Critical | DG Email Policy            | JIGS-TSVDA-1-FARBAUTI, J...   | JIGS-VDA-1-FARBAUTI   | Memory (%)              | Memory (%) >= 2              |
| 11/30/2023 3:52 PM | Critical | DG Email Policy            | JIGS-TSVDA-1-FARBAUTI, J...   | JIGS-VDA-1-FARBAUTI   | CPU (%)                 | CPU (%) >= 2                 |
| 11/30/2023 3:52 PM | Critical | Farbauti Site Email Policy | JIGS-FARBAUTI                 | JIGS-FARBAUTI         | CPU (%)                 | CPU (%) >= 2                 |
| 11/30/2023 3:42 PM | Critical | Multi Session OS Email     | All Server OS Machines in ... | JIGS\JIGS-TS-1-FARB   | CPU (%)                 | CPU (%) >= 2                 |
| 11/30/2023 3:42 PM | Critical | DG Email Policy            | JIGS-TSVDA-1-FARBAUTI, J...   | JIGS-TSVDA-1-FARBAUTI | CPU (%)                 | CPU (%) >= 2                 |
| 11/30/2023 3:04 PM | Critical | Hypervisor Health          | n/a                           | XenRT-R2A12-C08-B03   | Hypervisor Health       | Network usage alert has b... |

## Citrix alerts

Citrix alerts are alerts monitored in Director that originate from Citrix components. You can configure Citrix alerts within Director in **Alerts > Citrix Alerts Policy**. As part of the configuration, you can set notifications to be sent by email to individuals and groups when alerts exceed the thresholds you have set up. For more information on setting up Citrix Alerts, see [Create alerts policies](#).

### Note:

Ensure that your firewall, proxy, or Microsoft Exchange Server do not block the email alerts.

## Smart alert policies

A set of built-in alert policies with predefined threshold values is available for Delivery Groups and Multi-session OS VDA scope. This feature requires Delivery Controller(s) version 7.18 or later. You can modify the threshold parameters of the built-in alert policies in **Alerts > Citrix Alerts Policy**.

These policies are created when there is at least one alert target - a Delivery Group or a Multi-session OS VDA defined in your site. Additionally, these built-in alerts are automatically added to a new delivery group or a Multi-session OS VDA.

In case you upgrade Director and your site, the alert policies from your previous Director instance are carried over. Built-in alert policies are created only if no corresponding alert rules exist in the Monitor database.

For the threshold values of the built-in alert policies, see the Alerts policies conditions section.

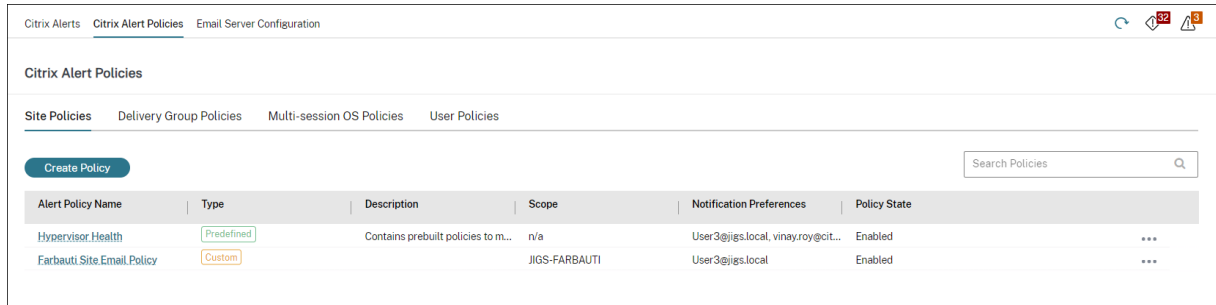

The screenshot shows the 'Citrix Alert Policies' page in the Citrix Director console. It features a navigation bar with 'Site Policies', 'Delivery Group Policies', 'Multi-session OS Policies', and 'User Policies'. Below the navigation is a 'Create Policy' button and a search bar. A table lists existing policies:

| Alert Policy Name          | Type       | Description                        | Scope         | Notification Preferences           | Policy State |
|----------------------------|------------|------------------------------------|---------------|------------------------------------|--------------|
| Hypervisor Health          | Predefined | Contains prebuilt policies to m... | n/a           | User3@jigs.local, vinay.roy@cit... | Enabled      |
| Farbauti Site Email Policy | Custom     |                                    | JIGS-FARBAUTI | User3@jigs.local                   | Enabled      |

## Create alerts policies

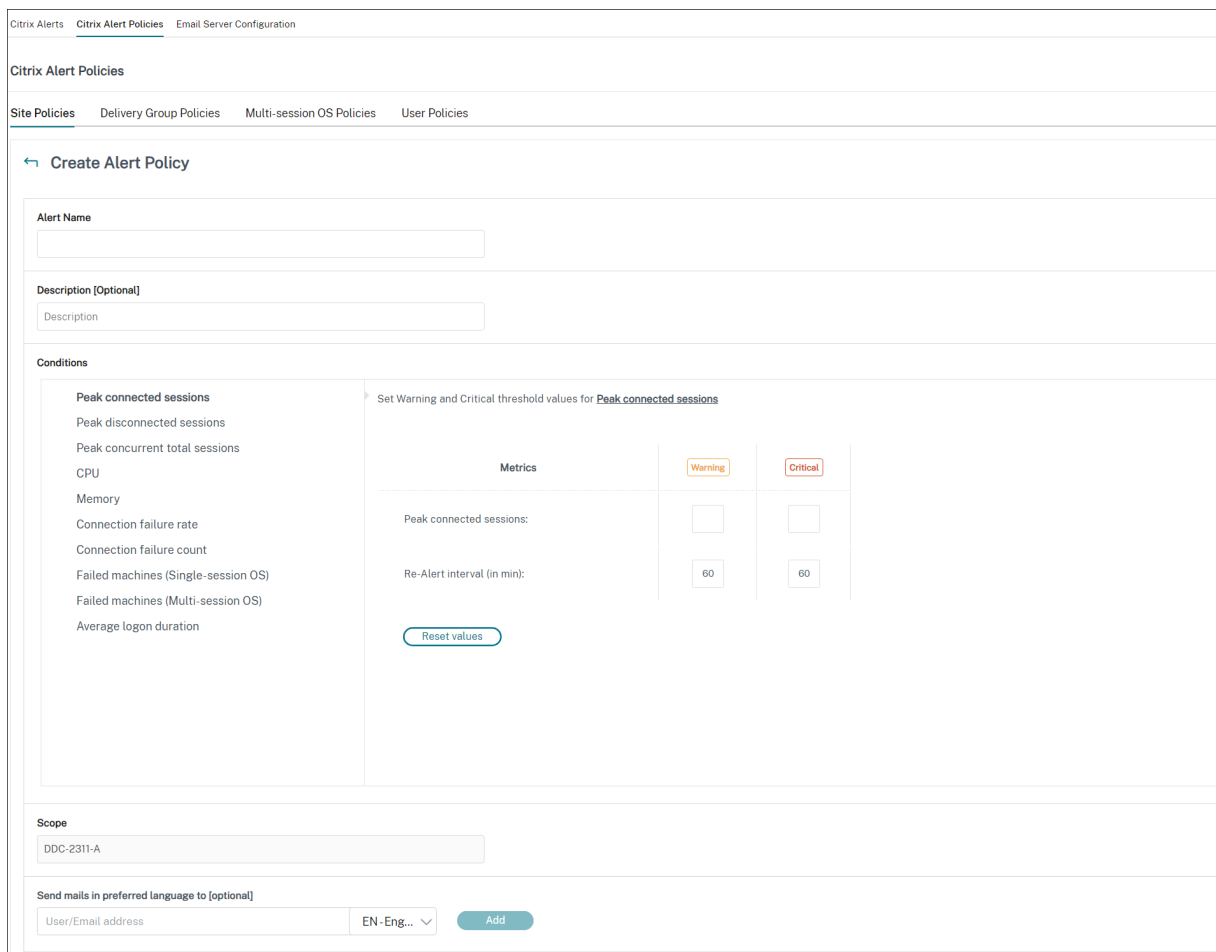

The screenshot shows the 'Create Alert Policy' form in the Citrix Director console. It includes the following sections:

- Alert Name:** A text input field.
- Description (Optional):** A text input field.
- Conditions:** A section for configuring alert conditions. It includes a list of metrics on the left and a configuration table on the right.
 

| Metrics                     | Warning              | Critical             |
|-----------------------------|----------------------|----------------------|
| Peak connected sessions:    | <input type="text"/> | <input type="text"/> |
| Re-Alert interval (in min): | 60                   | 60                   |
- Scope:** A text input field containing 'DDC-2311-A'.
- Send mails in preferred language to [optional]:** A section with a text input field for 'User/Email address', a dropdown menu for language (currently 'EN - Eng...'), and an 'Add' button.

To create a new alerts policy, for example, to generate an alert when a specific set of session count criteria is met:

1. Go to **Alerts > Citrix Alerts Policy** and select, for example, Multi-session OS Policy.
2. Click **Create**.
3. Name and describe the policy, then set the conditions that have to be met for the alert to be triggered. For example, specify Warning and Critical counts for Peak Connected Sessions, Peak Disconnected Sessions, and Peak Concurrent Total Sessions. Warning values must not be greater than Critical values. For more information, see [Alerts policies conditions](#).
4. Set the Re-alert interval. If the conditions for the alert are still met, the alert is triggered again at this time interval and, if set up in the alert policy, an email notification is generated. A dismissed alert does not generate an email notification at the re-alert interval.
5. Set the Scope. For example, set for a specific Delivery Group.
6. In Notification preferences, specify who should be notified by email when the alert is triggered. You have to specify an email server on the **Email Server Configuration** tab in order to set email Notification preferences in Alerts Policies.
7. Click **Save**.

Creating a policy with 20 or more Delivery Groups defined in the Scope might take approximately 30 seconds to complete the configuration. A spinner is displayed during this time.

Creating more than 50 policies for up to 20 unique Delivery Groups (1000 Delivery Group targets in total) might result in an increase in response time (over 5 seconds).

Moving a machine containing active sessions from one Delivery Group to another might trigger erroneous Delivery Group alerts that are defined using machine parameters.

**Note:**

After you delete an alert policy, it might take up to 30 minutes for the alert notifications generated by the policy to stop.

## Alerts policies conditions

Find below the alert categories, recommended actions to mitigate the alert, and built-in policy conditions if defined. The built-in alert policies are defined for alert and realert intervals of 60 minutes.

### Peak Connected Sessions

- Check Director Session Trends view for peak connected sessions.
- Check to ensure that there is enough capacity to accommodate the session load.
- Add new machines if needed

### Peak Disconnected Sessions

- Check Director Session Trends view for peak disconnected sessions.

- Check to ensure that there is enough capacity to accommodate session load.
- Add new machines if needed.
- Log off disconnected sessions if needed

### **Peak Concurrent Total Sessions**

- Check Director Session Trends view in Director for peak concurrent sessions.
- Check to ensure that there is enough capacity to accommodate session load.
- Add new machines if needed.
- Log off disconnected sessions if needed

### **CPU**

Percentage of CPU usage indicates the overall CPU consumption on the VDA, including that of the processes. You can get more insight into the CPU utilization by individual processes from the **Machine details** page of the corresponding VDA.

- Go to **Machine Details > View Historical Utilization > Top 10 Processes**, identify the processes consuming CPU. Ensure that process monitoring policy is enabled to initiate collection of process level resource usage statistics.
- End the process if necessary.
- Ending the process causes unsaved data to be lost.
- If all is working as expected, add additional CPU resources in the future.

#### **Note:**

The policy setting, **Enable resource monitoring** is allowed by default for the monitoring of CPU and memory performance counters on machines with VDAs. If this policy setting is disabled, alerts with CPU and memory conditions are not triggered. For more information, see [Monitoring policy settings](#)

#### **Smart policy conditions:**

- **Scope:** Delivery Group, Multi-session OS scope
- **Threshold values:** Warning - 80%, Critical - 90%

### **Memory**

Percentage of Memory usage indicates the overall memory consumption on the VDA, including that of the processes. You can get more insight into the memory usage by individual processes from the **Machine details** page of the corresponding VDA.

- Go to **Machine Details > View Historical Utilization > Top 10 Processes**, identify the processes consuming memory. Ensure that process monitoring policy is enabled to initiate collection of process level resource usage statistics.
- End the process if necessary.
- Ending the process causes unsaved data to be lost.
- If all is working as expected, add additional memory in the future.

**Note:**

The policy setting, **Enable resource monitoring**, is allowed by default for the monitoring of CPU and memory performance counters on machines with VDAs. If this policy setting is disabled, alerts with CPU and memory conditions are not triggered. For more information, see [Monitoring policy settings](#)

**Smart policy conditions:**

- **Scope:** Delivery Group, Multi-session OS scope
- **Threshold values:** Warning - 80%, Critical - 90%

### Connection Failure Rate

Percentage of connection failures over the last hour.

- Calculated based on the total failures to total connections attempted.
- Check Director Connection Failures Trends view for events logged from the Configuration log.
- Determine if applications or desktops are reachable.

### Connection Failure Count

Number of connection failures over the last hour.

- Check Director Connection Failures Trends view for events logged from the Configuration log.
- Determine if applications or desktops are reachable.

### ICA RTT (Average)

Average ICA round-trip time.

- Check Citrix ADM for a breakdown of the ICA RTT to determine the root cause. For more information, see [Citrix ADM](#) documentation.
- If Citrix ADM is not available, check the Director User Details view for the ICA RTT and Latency, and determine if it is a network problem or an issue with applications or desktops.

### ICA RTT (No. of Sessions)

Number of sessions that exceed the threshold ICA round-trip time.

- Check Citrix ADM for the number of sessions with high ICA RTT. For more information, see [Citrix ADM](#) documentation.
- If Citrix ADM is not available, work with the network team to determine the root cause.

#### Smart policy conditions:

- **Scope:** Delivery Group, Multi-session OS scope
- **Threshold values:** Warning - 300 ms for 5 or more sessions, Critical - 400ms for 10 or more sessions

### ICA RTT (% of Sessions)

Percentage of sessions that exceed the average ICA round-trip time.

- Check Citrix ADM for the number of sessions with high ICA RTT. For more information, see [Citrix ADM](#) documentation.
- If Citrix ADM is not available, work with the network team to determine the root cause.

### ICA RTT (User)

ICA round-trip time that is applied to sessions launched by the specified user. The alert is triggered if ICA RTT is greater than the threshold in at least one session.

### Failed Machines (Single-session OS)

Number of failed Single-session OS machines. Failures can occur for various reasons as shown in the Director Dashboard and Filters views.

- Run Citrix Scout diagnostics to determine the root cause.

#### Smart policy conditions:

- **Scope:** Delivery Group, Multi-session OS scope
- **Threshold values:** Warning - 1, Critical - 2



### **Failed Machines (Multi-session OS)**

Number of failed Multi-session OS machines. Failures can occur for various reasons as shown in the Director Dashboard and Filters views.

- Run Citrix Scout diagnostics to determine the root cause.

#### **Smart policy conditions:**

- **Scope:** Delivery Group, Multi-session OS scope
- **Threshold values:** Warning - 1, Critical - 2

### **Failed Machines (in %)**

Percentage of failed single-session and multi-session OS machines in a delivery group calculated based on the number of failed machines. This alert condition allows you to configure alert thresholds as a percentage of failed machines in a delivery group and is calculated every 30 seconds.

Failures can occur for various reasons as shown in the Director Dashboard and Filters views. Run Citrix Scout diagnostics to determine the root cause. For more information, see [Troubleshoot user issues](#).

### **Average Logon Duration**

Average logon duration for logons that occurred over the last hour.

- Check the Director Dashboard to get up-to-date metrics regarding the logon duration. A large number of users logging in during a short timeframe can increase the logon duration.
- Check the baseline and break down of the logons to narrow down the cause. For more information, see [Diagnose user logon issues](#)

#### **Smart policy conditions:**

- **Scope:** Delivery Group, Multi-session OS scope
- **Threshold values:** Warning - 45 seconds, Critical - 60 seconds

### **Logon Duration (User)**

Logon duration for logons for the specified user that occurred over the last hour.

## Load Evaluator Index

Value of the Load Evaluator Index over the last 5 minutes.

- Check Director for Multi-session OS Machines that might have a peak load (Max load). View both Dashboard (failures) and Trends Load Evaluator Index report.

### Smart policy conditions:

- **Scope:** Delivery Group, Multi-session OS scope
- **Threshold values:** Warning - 80%, Critical - 90%

## Hypervisor Alerts Monitoring

Director displays alerts to monitor hypervisor health. Alerts from XenServer and VMware vSphere help monitor hypervisor parameters and states. The connection status to the hypervisor is also monitored to provide an alert if the cluster or pool of hosts is rebooted or unavailable.

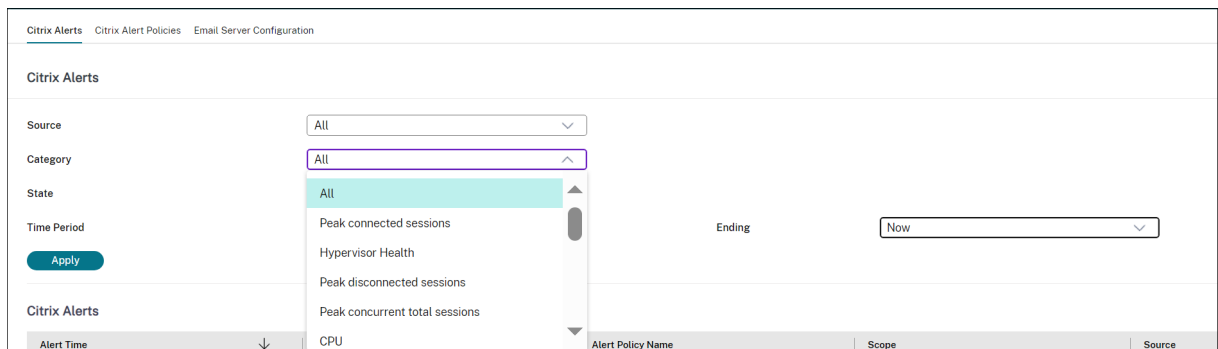

To receive hypervisor alerts, ensure that a hosting connection is created in Web Studio. For more information, see [Connections and resources](#). Only these connections are monitored for hypervisor alerts.

These alerts are displayed once the thresholds are reached or exceeded. Hypervisor alerts can be:

- **Critical**—critical threshold of the hypervisor alarm policy reached or exceeded
- **Warning**—warning threshold of the hypervisor alarm policy reached or exceeded
- **Dismissed**—alert no longer displayed as an active alert

| Alert Time         | Status   | Alert Policy Name                               | Scope                                                | Source                   | Category                | Description                                                 |
|--------------------|----------|-------------------------------------------------|------------------------------------------------------|--------------------------|-------------------------|-------------------------------------------------------------|
| 10/10/2023 6:27 AM | Critical | Hypervisor Health                               | n/a                                                  | MCS-163-aaa-hdc34_131.12 | Hypervisor Health       | Network usage alert has been triggered on the Hypervisor... |
| 10/10/2023 6:27 AM | Critical | Hypervisor Health                               | n/a                                                  | MCS-163-aaa-hdc34_131.12 | Hypervisor Health       | CPU usage alert has been triggered on the Hypervisor...     |
| 10/10/2023 6:26 AM | Critical | New MS (231)-231                                | All Server OS machines in TSVGA-2311-B               | HSSTSVGA-B-2311          | CPU (%)                 | CPU (%) >= 2                                                |
| 10/10/2023 6:25 AM | Critical | New OS (231)-231                                | TSVGA-2311-B, VDA 2311-A                             | TSVGA-2311-B             | CPU (%)                 | CPU (%) >= 2                                                |
| 10/10/2023 6:22 AM | Critical | Smart Alert: Server VDA Health Notification     | All Multi-session OS machines in All Delivery Groups | HSSTSVGA-B-2311          | Average Logon Duration  | Average Logon Duration >= 60                                |
| 10/10/2023 6:22 AM | Critical | Smart Alert: Delivery Group Health Notification | All Delivery Groups                                  | TSVGA-2311-B             | Average Logon Duration  | Average Logon Duration >= 60                                |
| 10/10/2023 6:20 AM | Critical | New Sdk (231)-231                               | DDC-2311-A                                           | DDC-2311-A               | Peak Connected Sessions | Peak Connected Sessions >= 2                                |
| 10/10/2023 6:22 AM | Critical | Hypervisor Health                               | n/a                                                  | MCS-163-aaa-hdc34_131.12 | Hypervisor Health       | Memory usage alert has been triggered on the Hypervisor...  |
| 10/10/2023 6:21 AM | Critical | New Sdk (231)-231                               | DDC-2311-A                                           | DDC-2311-A               | CPU (%)                 | CPU (%) >= 2                                                |
| 10/10/2023 6:20 AM | Critical | New MS (231)-231                                | All Server OS machines in TSVGA-2311-B               | HSSTSVGA-B-2311          | Peak Connected Sessions | Peak Connected Sessions >= 2                                |

This feature requires Delivery Controller version 7 1811 or later. If you are using an older version of Director with sites 7 1811 or later, only the hypervisor alert count is displayed. To view the alerts, you must upgrade Director.

The following table describes the various parameters and states of Hypervisor alerts.

| Alert                             | Supported Hypervisors     | Triggered by        | Condition                                                                                                                                                        | Configuration                                                                              |
|-----------------------------------|---------------------------|---------------------|------------------------------------------------------------------------------------------------------------------------------------------------------------------|--------------------------------------------------------------------------------------------|
| CPU usage                         | XenServer, VMware vSphere | Hypervisor          | CPU usage alert threshold is reached or exceeded                                                                                                                 | Alert thresholds must be configured in the Hypervisor.                                     |
| Memory usage                      | XenServer, VMware vSphere | Hypervisor          | Memory usage alert threshold is reached or exceeded                                                                                                              | Alert thresholds must be configured in the Hypervisor.                                     |
| Network usage                     | XenServer, VMware vSphere | Hypervisor          | Network usage alert threshold is reached or exceeded                                                                                                             | Alert thresholds must be configured in the Hypervisor.                                     |
| Disk usage                        | VMware vSphere            | Hypervisor          | Disk usage alert threshold is reached or exceeded                                                                                                                | Alert thresholds must be configured in the Hypervisor.                                     |
| Host connection or power state    | VMware vSphere            | Hypervisor          | Hypervisor Host has been rebooted or is unavailable                                                                                                              | Alerts are prebuilt in VMware vSphere. No additional configurations are needed.            |
| Hypervisor connection unavailable | XenServer, VMware vSphere | Delivery Controller | Connection to the hypervisor (pool or cluster) is lost or powered down or rebooted. This alert is generated every hour as long as the connection is unavailable. | Alerts are prebuilt with the Delivery Controller. No additional configurations are needed. |

**Note:**

For more information about configuring alerts, see [Citrix XenCenter Alerts](#) or check the VMware vCenter Alerts documentation.

Email notification preference can be configured under **Citrix Alerts Policy > Site Policy > Hypervisor Health**. The threshold conditions for Hypervisor alert policies can be configured, edited, disabled, or deleted from the hypervisor only and not from Director. However, modifying email preferences and dismissing an alert can be done in Director. You can disable the alert if your role does not involve infrastructure monitoring.

**Important:**

- Alerts triggered by the Hypervisor are fetched and displayed in Director. However, changes in the life cycle/state of the Hypervisor alerts are not reflected in Director.
- Alerts that are healthy or dismissed or disabled in the Hypervisor console continues to appear in Director and have to be dismissed explicitly.
- Alerts that are dismissed in Director are not dismissed automatically in the Hypervisor console.

## Filter data to troubleshoot failures

August 14, 2023

When you click numbers on the Dashboard or select a predefined filter from the Filters menu, the Filters view opens to display data based on the selected machine or failure type.

Predefined filters cannot be edited, but you can save a predefined filter as a custom filter and then modify it. Also, you can create custom filtered views of machines, connections, sessions, and application instances across all delivery groups.

1. Select a view:

- **Machines.** Select Single-session OS Machines or Multi-session OS Machines. These views show the number of configured machines. The Multi-session OS Machines tab also includes the load evaluator index, which indicates the distribution of performance counters and tool tips of the session count if you hover over the link.
- **Sessions.** You can also see the session count from the Sessions view. Use the idle time measurements to identify sessions that are idle beyond a threshold time period. Click the **Associated User** to open the Activity Manager for the user. Clicking the **Endpoint** name opens the Activity Manager for the Endpoint. Clicking **View Details** opens the **User Details** or **Endpoint Details** page respectively. For more information, see [User Details](#).

- **Connections.** Filter connections by different time periods, including last 60 minutes, last 24 hours, or last 7 days.
- **Application Instances.** This view displays the properties of all application instances on VDAs of Server and Single-session OS. The session idle time measurements are available for Application instances on VDAs of Multi-session OS.

**Note:**

If you have launched Desktop sessions on VDAs installed on a Windows 10 1809 computer, the Activity Manager in Director might sometimes display Microsoft Edge and Office as actively running applications while they are actually running only in the background.

2. For **Filter by**, select the criteria.
3. Use the additional tabs for each view, as needed, to complete the filter.
4. Select extra columns, as needed, to troubleshoot further.
5. Save and name your filter.
6. To access filters from multiple Director servers, store the filters on a shared folder accessible from those servers:
  - The shared folder must have modify permissions for accounts on the Director server.
  - The Director servers must be configured to access the shared folder. To configure, run **IIS Manager**. In **Sites > Default Web Site > Director\ > Application Settings**, modify the **Service.UserSettingsPath** setting to reflect the UNC path of the shared folder.
7. To open the filter later, from the **Filters** menu, select the filter type (Machines, Sessions, Connections, or Application Instances), and then select the saved filter.
8. Click **Export** to export the data to CSV format files. Data of up to 100,000 records can be exported. This feature is available in Delivery Controller version 1808 and later.
9. If needed, for **Machines** or **Connections** views, use power controls for all the machines you select in the filtered list. For the Sessions view, use the session controls or option to send messages.
10. In the **Machines** and **Connections** views, click the **Failure Reason** of a failed machine or connection to get a detailed description of the failure and actions recommended to troubleshoot the failure. The failure reasons and the recommended actions for Machine and Connection failures are available in [Citrix Director failure reasons and troubleshooting](#).
11. In the **Machines** view, click a machine name link to go to the corresponding **Machine Details** page. This page displays the details of the machine, provides power controls, displays the CPU, memory, disk monitoring, and GPU monitoring graphs. Also, click **View Historical Utilization**

to see the resource utilization trends for the machine. For more information, see [Troubleshoot machines](#).

12. In the **Application Instances** view, sort or filter based on **Idle Time** greater than a threshold time period. Select the idle application instances to end. Log off or Disconnect of an application instance ends all active application instances in the same session. For more information, see [Troubleshoot applications](#). The Application Instances filter page and idle time measurements in the Sessions filter pages are available if Director, Delivery Controllers, and VDAs are version 7.13 or later.

**Note:**

Web Studio allows assignment of multiple Desktop Assignment Rules (DAR) for different users or user groups to a single VDA in the delivery group. StoreFront displays the assigned desktop with the corresponding Display Name as per the DAR for the logged in user. However, Director does not support DARs and displays the assigned desktop using the delivery group name regardless of the logged in user. As a result, you cannot map a specific desktop to a machine in Director. To map the assigned desktop displayed in StoreFront to the delivery group name displayed in Director, use the following PowerShell command:

```
1 Get-BrokerDesktopGroup | Where-Object {
2 $_.Uid -eq (Get-BrokerAssignmentPolicyRule | Where-Object {
3 $_.PublishedName -eq "<Name on StoreFront>" }
4).DesktopGroupUid }
5 | Select-Object -Property Name, Uid
6 <!--NeedCopy-->
```

## Monitor historical trends across a site

July 10, 2023

The Trends view accesses historical trend information of each site for the following parameters:

- sessions
- connection failures
- machine failures
- logon performance
- load evaluation
- capacity management
- machine usage
- resource utilization
- network analysis for each site.

To locate this information, click the **Trends** menu.

The zoom-in drill down feature lets you navigate through trend charts by zooming in on a time period (clicking a data point in the graph) and drilling down to see the details associated with the trend. This feature enables you to better understand the details of who or what is affected.

To change the default scope of each graph, apply a different filter to the data.

Choose a time period for which you require the historical trend information. Time period availability depends on your Director deployment as follows:

- Trend reports of up to Last year (365 days) are available in Premium licensed sites.
- Trend reports of up to Last month (31 days) are available in Advanced licensed sites.
- Trend reports of up to Last 7 days in non-Premium and non-Advanced licensed sites.

**Note:**

- In all Director deployments, sessions, failures, and logon performance trend information are available as graphs and tables when the time period is set to Last month (**Ending now**) or shorter. For the time period chosen as Last month with a custom ending date or as Last year, the trend information is available as graphs and not as tables.
- Grooming retention values of the Monitor Service control the trends data availability. The default values are available in [Data granularity and retention](#). Customers on Premium licensed sites can change the grooming retention to their desired number of retention days.
- The following parameters in IIS Manager control the range of custom ending dates available for selection. However, the data availability for selected dates depends on the grooming retention setting for the specific metric being measured.

---

| <b>Parameter</b>          | <b>Default values</b> |
|---------------------------|-----------------------|
| UI.TrendsLast2HoursRange  | 3                     |
| UI.TrendsLast24HoursRange | 32                    |
| UI.TrendsLast7DaysRange   | 32                    |
| UI.TrendsLastMonthRange   | 365                   |

---

## Available trends

**View trends for sessions:** From the **Sessions** tab, select the Delivery Group and time period to view more detailed information about the concurrent session count.

The **Session Auto Reconnect** column displays the number of auto reconnects in a session. Auto reconnect is enabled when the Session Reliability or the Auto Client Reconnect policies are in effect. When there is a network interruption on the endpoint, the following policies come into effect:

- Session reliability comes into effect (by default for 3 minutes) where the Citrix Receiver or Citrix Workspace app tries to connect to the VDA.
- Auto client reconnect comes into effect between 3 and 5 minutes where the client tries to connect to the VDA.

Both reconnects are captured and displayed to the user. This information can take a maximum time of 5 minutes to appear on the Director UI after the reconnect has occurred.

The auto reconnect information helps you view and troubleshoot network connections having interruptions. It also analyzes networks having a seamless experience. You can view the number of reconnects for a specific Delivery Group or time period selected in the Filters. A drilldown provides additional information like Session Reliability or Auto Client Reconnect, time stamps, Endpoint IP, and Endpoint Name of the machine where Workspace app is installed.

By default, logs are sorted by the event time stamps in descending order. This feature is available for Citrix Workspace app for Windows, Citrix Workspace app for Mac, Citrix Receiver for Windows, and Citrix Receiver for Mac. This feature requires Delivery Controller version 7 1906 or later, and VDAs 1906 or later.

For more information about session reconnections, see [Sessions](#).

For more information about policies, see [Auto client reconnect policy settings](#) and [Session reliability policy settings](#).

Sometimes, the auto reconnect data might not appear in Director for the following reasons:

- Workspace app is not sending auto reconnect data to VDA.
- VDA is not sending data to the monitor service.
- Delivery Controllers discard VDA payloads as they might not have the corresponding sessions.

**Note:**

Sometimes, the client IP address might not be obtained correctly if certain Citrix Gateway policies are set.

**View trends for connection failures:** From the Failures tab, select the connection, machine type, failure type, Delivery Group, and time period to view a graph containing more detailed information about the user connection failures across your site.

**View trends for machine failures:** From the **Single-session OS Machine Failures** tab or Multi-session OS Machines tab, select the failure type, Delivery Group, and time period to view a graph containing more detailed information about the machine failures across your site.



**View trends for logon performance:** From the **Logon Performance** tab, select the Delivery Group and time period to view a graph containing more detailed information about the duration of user logon times across your site and whether the number of logons affects the performance. This view also shows the average duration of the logon phases, such as brokering duration and VM start time. This data is specifically for user logons and does not include users trying to reconnect from disconnected sessions.

The table below the graph shows Logon Duration by User Session. You can choose the columns to display and sort the report by any of the columns.

For more information, see [Diagnose user logon issues](#)

**View trends for load evaluation:** From the **Load Evaluator Index** tab, view a graph containing more detailed information about the load that is distributed among Multi-session OS machines. The filter options for this graph include the Delivery Group or Multi-session OS machine in a Delivery Group, Multi-session OS machine (available only if the Multi-session OS machine in a Delivery Group was selected), and range.

**View hosted applications usage:** The availability of this feature depends on your organization's license.

From the **Capacity Management** tab, select the **Hosted Applications Usage** tab. Select the Delivery Group and time period to view a graph displaying peak concurrent usage and a table displaying application based usage. From the Application Based Usage table, you can choose a specific application to see details and a list of users who are using, or have used, the application.

**View Single-session and Multi-session OS usage:** The Trends view shows the usage of Single-session OS by site and by Delivery Group. When you select **Site**, usage is shown per Delivery Group. When you select Delivery Group, usage is shown per User.

The Trends view also shows the usage of Multi-session OS by site, by Delivery Group, and by Machine. When you select **Site**, usage is shown per Delivery Group. When you select Delivery Group, usage is shown per Machine and per User. When Machine is selected usage is shown per User.

**View virtual machine usage:** From the **Machine Usage** tab, select **Single-session OS Machines or Multi-session OS Machines** to obtain a real-time view of your VM usage, enabling you to quickly assess your site's capacity needs.

Single-session OS availability - displays the current state of Single-session OS machines (VDIs) by availability for the entire site or a specific Delivery Group.

Multi-session OS availability - displays the current state of Multi-session OS machines by availability for the entire site or a specific Delivery Group.

**Note:**

The number of machines displayed in Available Counter includes machines in maintenance mode.

**View resource utilization:** From the **Resource Utilization** tab, select **Single-session OS Machines**

**or Multi-session OS Machines** to obtain insight into historical trends data for CPU and memory usage, and IOPS and disk latency for each VDI machine for better capacity planning.

This feature requires Delivery Controllers and VDAs **version 7.11** or later.

Graphs show data for average CPU, average memory, average IOPS, disk latency, and peak concurrent sessions. You can drill down to the machine, and view data and charts for the top 10 processes consuming CPU.

Filter by Delivery Group and Time period. CPU, memory usage, and peak concurrent sessions graphs are available for the last 2 hours, 24 hours, 7 days, month, and year. The average IOPS and disk latency graphs are available for the last 24 hours, month, and year.

**Note:**

- The Monitoring policy setting, **Enable Process Monitoring**, must be set to **Allowed** to collect and display data in the Top 10 Processes table on the Historic Machine Utilization page. The policy is set to **Prohibited** by default. All resource utilization data is collected by default. This can be disabled using the **Enable Resource Monitoring** policy setting. The table below the graphs shows the resource utilization data per machine. For more information, see [Monitoring policy settings](#).
- Average IOPS shows the daily averages. Peak IOPS is calculated as the highest of the IOPS averages for the selected time range. (An IOPS average is the hourly average of IOPS collected during the hour on the VDA).
- The machine drilldown lists processes with average CPU or average memory usage more than 1%, this could mean that sometimes fewer than 10 processes are listed.

**View network analysis data:** The availability of this feature depends on your organization's license and your administrator permissions. This feature requires Delivery Controllers **version 7.11** or later.

From the **Network** tab, monitor your network analysis, which provides a user, application, and desktop contextual view of the network. With this feature, Director provides advanced analytics of ICA traffic in your deployment through HDX Insight reports from Citrix ADM. For more information, see [Configure network analysis](#)

**View application failures:** The **Application Failures** tab displays failures associated with the published applications on the VDAs.

This feature requires Delivery Controllers and VDAs **version 7.15** or later. Single-session OS VDAs running Windows Vista and later, and Multi-session OS VDAs running Windows Server 2008 and later are supported.

For more information, see [Historical application failure monitoring](#).

By default, only application faults from Multi-session OS VDAs are displayed. You can set the monitoring of application failures by using Monitoring policies. For more information, see [Monitoring policy](#)

[settings](#).

**View probe results:** The **Probe Results** tab displays the results of probe for applications and desktops that have been configured for probing in the Configuration page. Here, the stage of launch during which the failure occurred is recorded.

For more information see [Application and Desktop Probing](#).

**Create customized reports:** The Custom Reports tab provides a user interface for generating Custom Reports containing real-time and historical data from the Monitoring database in tabular format.

This feature requires Delivery Controllers **version 7.12** or later.

From the list of previously saved Custom Report queries, you can click **Run and download** to export the report in CSV format, click **Copy OData** to copy and share the corresponding OData query, or click **Edit** to edit the query.

You can create a Custom Report query based on machines, connections, sessions, or application instances. Specify filter conditions based on fields such as machine, Delivery Group, or time period. Specify additional columns required in your Custom Report. Preview displays a sample of the report data. Saving the Custom Report query adds it to the list of saved queries.

You can create a Custom Report query based on a copied OData query. To do this, select the OData Query option and paste the copied OData query. You can save the resultant query for execution later.

**Note:**

The column names in Preview and Export report generated using OData queries are not localized, but appear in English.

The flag icons on the graph indicate significant events or actions for that specific time range. Hover the mouse over the flag and click to list events or actions.

**Note:**

- HDX connection logon data is not collected for VDAs earlier than 7. For earlier VDAs, the chart data is displayed as 0.
- Delivery Groups deleted in Citrix Studio are available for selection in the Director Trends filters until data related to them are groomed out. Selecting a deleted Delivery Group displays graphs for available data until retention. However, the tables don't show data.
- Moving a machine containing active sessions from one Delivery Group to another causes the **Resource Utilization and Load Evaluator Index** tables of the new Delivery Group to display metrics consolidated from the old and new Delivery Groups.

## Monitor Autoscale-managed machines

May 11, 2023

Autoscale is a power management feature that enables proactive power management of all registered Multi-session and Single session OS machines in a delivery group. You can configure Autoscale for a selected delivery group in Web Studio. For more information, see [Autoscale](#).

You can monitor the key metrics of Autoscale enabled machines using Director.

### Machine Usage

The **Machine Usage** page displays the total number of Autoscale enabled multi-session and single-session OS machines that are powered on for a selected delivery group and time period. This metric indicates the actual usage of machines in the delivery group.

From the **Single session OS Machines** or the **Multi-session OS Machines** tab, select the Delivery group and the time period.

The chart plots the following metrics:

- **Machines On** - the number of Autoscale enabled machines that are powered on
- **Machines Registered** - the number of registered Multi-session or Single session OS machines
- **Machines under Maintenance** - the number of Multi-session or Single session OS machines with maintenance mode switched on

### Estimated Savings

The **Machine Usage** page also displays the estimated cost savings achieved by enabling Autoscale in the selected delivery group.

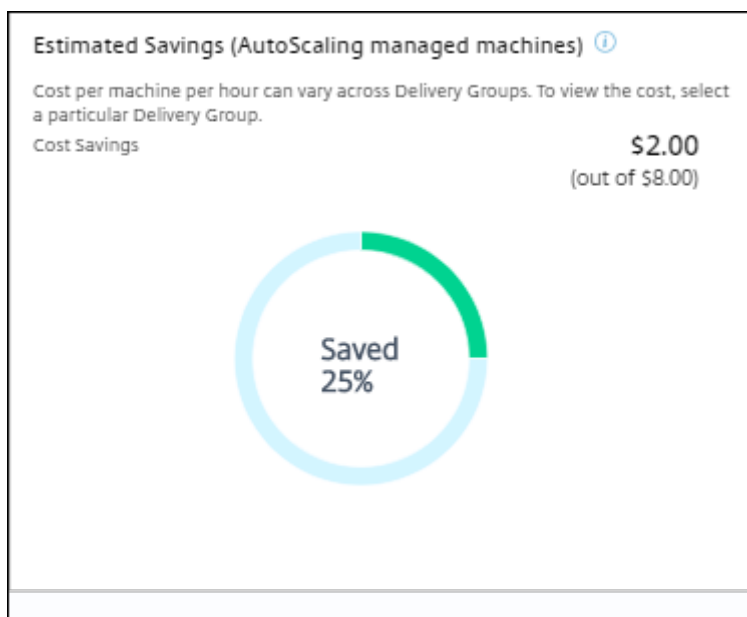

Estimated Savings is calculated as the percentage of savings per machine per hour (in US \$) as configured in **Edit Delivery Group > Autoscale**. For more information about configuring the savings per machine, see [Autoscale](#).

When you select all Delivery groups, the average value of Estimated Savings across all the delivery groups is displayed.

The estimated savings help administrators consolidate the existing infrastructure and plan the capacity to achieve maximum savings and utilization.

## Alert notifications for machines and sessions

The Director Dashboard displays alert notifications that can be further drilled down. Alert details are displayed on the **Alerts** page.

- To create an alert policy in a delivery group, go to **Alerts > Citrix Alerts Policy > Delivery Group Policy**.
- Here, you can set the following Warning and Critical thresholds:
  - Failed Machines (Single-session OS) and Failed Machines (Multi-session OS),
  - Peak Connected Sessions, Peak Disconnected Sessions and Peak Concurrent Total Sessions in the delivery group.
- Alerts are generated when the corresponding metric in the delivery group reaches the threshold.

For more details regarding the alert policy conditions and creation of new alert policies, see [Alerts and notifications](#).

## Machine status

- **Filters > Machines** displays the power state of all machines in a tabular format. You can filter by a specific delivery group.
- **Filters > Sessions** displays filter by the Machine name to see the associated sessions and their real-time status.
- In **Trends > Sessions**, select your delivery group and time period to see the trend of the sessions and their associated metrics.

For more information, see [Filter data to troubleshoot failures](#).

## Load Evaluation trends

The **Trends > Load Evaluator Index** page displays a graph with detailed information about the load that is distributed among the Multi-session OS machines. The filter options for this graph include the delivery group or Multi-session OS machine in a delivery group, Multi-session OS machine (available only if Multi-session OS machine in a delivery group was selected), and range. The Load Evaluator Index is displayed as percentages of Total CPU, Memory, Disk, or Sessions and is shown in comparison with the number of connected users in the last interval.

## Troubleshoot deployments

June 21, 2020

As a help desk administrator, you can search for the user reporting an issue and display details of sessions or applications associated with that user. Similarly, search for machines or endpoints where issues are reported. Resolve issues quickly by monitoring the relevant metrics and performing suitable actions.

Available actions include:

- Ending an unresponsive application or process
- Shadowing operations on the user's machine
- Logging off an unresponsive session
- Restarting the machine
- Putting a machine into maintenance mode
- Resetting the user profile

## Troubleshoot applications

August 9, 2023

### Application Analytics

The **Applications** view displays application-based analytics in a single, consolidated view to help analyze and manage application performance efficiently. You can gain valuable insight into the health and usage information of all applications published on the site. The default view helps identify the top running applications.

This feature requires Delivery Controllers Version 7.16 or later and VDAs Version 7.15 or later.



| Application Name    | Probe Result | Instances | Application Faults | Application Errors |
|---------------------|--------------|-----------|--------------------|--------------------|
| Customized Desktops | OK           | 0         | 0                  | 0                  |
| CitrixReceiver      | Fail         | 1         | 0                  | 0                  |
| CitrixWorkspace     | OK           | 0         | 0                  | 0                  |
| Google Chrome       | OK           | 0         | 0                  | 0                  |
| PassAppCenter       | Fail         | 0         | 0                  | 0                  |
| AppCenter           | Fail         | 0         | 0                  | 0                  |

The **Probe Result** column displays the result of application probing run in the last 24 hours. Click the probe result link to see more details in the **Trends > Application Probe Results** page. For more details on how to configure application probes, see [Application and Desktop Probing](#).

The **Instances** column displays usage of the applications. It indicates the number of application instances currently running (both connected and disconnected instances). To troubleshoot further, click the **Instances** field to see the corresponding **Application Instances** filters page. Here, you can select application instances to log off or disconnect.

#### Note:

For custom scope administrators, Director does not display application instances created under application groups. To view all application instances, you must be a full administrator. For more information, see Knowledge Center article [CTX256001](#).

Monitor the health of published applications in your site with the **Application Faults** and the **Application Errors** columns. These columns display the aggregated number of faults and errors that have occurred while launching the corresponding application in the last one hour. Click the **Application Faults** or **Application Errors** field to see failure details on the **Trends > Application Failures** page corresponding to the selected application.

The application failure policy settings govern the availability and display of faults and errors. For more information about the policies and how to modify them, see [Policies for application failure monitoring](#) in **Monitoring policy** settings.

## Real-time application monitoring

You can troubleshoot applications and sessions by using the idle time metric to identify instances that are idle beyond a specific time limit.

Typical use cases for application-based troubleshooting are in the healthcare sector, where employees share application licenses. There, you must end idle sessions and application instances to purge the Citrix Virtual Apps and Desktops environment, to reconfigure poorly performing servers, or to maintain and upgrade applications.

The **Application Instances** filter page lists all application instances on VDAs of Server and Single-session OS. The associated idle time measurements are displayed for application instances on VDAs of Multi-session OS that have been idle for at least 10 minutes.

### Note:

The Application Instances metrics are available on sites of all license editions.

Use this information to identify the application instances that are idle beyond a specific time period and log off or disconnect them as appropriate. To do this, select **Filters > Application Instances** and select a pre-saved filter or choose **All Application Instances** and create your own filter.

| Published Name   | Login Time         | Idle Time (hh:mm:ss) | Associated U... | Anonymous | Machine Name | IP Address | Endpoint Na... | Endpoint IP |
|------------------|--------------------|----------------------|-----------------|-----------|--------------|------------|----------------|-------------|
| Command Prompt-1 | 12/05/2023 1:24... | 04:15                | User2           | No        |              |            |                |             |

An example of a filter would be as follows. As **Filter by** criteria, choose **Published Name** (of the application) and **Idle Time**. Then, set **Idle Time** to **greater than or equal to** a specific time limit and save the filter for reuse. From the filtered list, select the application instances. Select option to send messages or from the **Session Control** drop-down, choose **Logoff** or **Disconnect** to end the instances.

### Note:

Logging off or disconnecting an application instance logs off or disconnects the current session, thereby ending all application instances that belong to the same session.

You can identify idle sessions from the **Sessions** filter page using the session state and the session idle time metric. Sort by the **Idle Time** column or define a filter to identify sessions that are idle beyond a



specific time limit. Idle time is listed for sessions on VDAs of Multi-session OS that have been idle for at least 10 minutes.

The screenshot shows the 'Filters - All Sessions' view in the Citrix console. It includes a sidebar with navigation options like Dashboard, Trends, Alerts, Applications, Probes, and Analytics. The main area displays a table of sessions. The 'Idle Time (h:mm)' column is highlighted with a red box, showing values for four sessions: 03:59, 30:23, 04:17, and 28:18.

| Associated User | Session State | Session Start Time | Anonymous | Endpoint Name | Endpoint IP | Citrix Workspace App... | Machine Name | IP Address | Idle Time (h:mm) |
|-----------------|---------------|--------------------|-----------|---------------|-------------|-------------------------|--------------|------------|------------------|
| User0           | Active        | 12/05/2023 2:01 AM | No        |               |             | 23.91.104               |              |            | 03:59            |
| User2           | Disconnected  | 11/30/2023 4:29 AM | No        |               |             | 23.91.104               |              |            | 30:23            |
| User2           | Active        | 12/05/2023 1:24 AM | No        |               |             | 23.91.104               |              |            | 04:17            |
| User8           | Disconnected  | 12/01/2023 3:25 AM | No        |               |             | 23.91.104               |              |            | 28:18            |

The **Idle time** is displayed as **N/A** when the session or application instance

- has not been idle for more than 10 minutes,
- is launched on a VDA of Single-session OS, or
- is launched on a VDA running Version 7.12 or earlier.

### Historical application failure monitoring

The **Trends -> Application Failures** tab displays failures associated with the published applications on the VDAs.

Application failure trends are available for the last 2 hours, 24 hours, 7 days, and month for Premium and Advanced licensed sites. They are available for the last 2 hours, 24 hours, and 7 days for other license types. The application failures that are logged to the Event Viewer with source “Application Errors” are monitored. Click **Export** to generate reports in CSV, Excel, or PDF formats

The grooming retention settings for application failure monitoring, GroomApplicationErrorsRetentionDays and GroomApplicationFaultsRetentionDays are set to one day by default for both Premium and non-Premium licensed sites. You can change this setting using the PowerShell command:

```
PowerShell command Set-MonitorConfiguration -\<setting name\> \<value \> <!--NeedCopy-->
```

The screenshot displays the 'Application Failures' monitoring page. It includes a search and filter section with fields for Application Name, Process Name, Delivery Group (set to 'All'), and Time Period (set to 'Last Month'). Below this is a table of application faults. A tooltip is shown over the first entry, providing detailed error information:

```

Failing application name: gup.exe, version: 5.1.1.0, time stamp: 0x5da630b7
Failing module name: gup.exe, version: 5.1.1.0, time stamp: 0x5da630b7
Exception code: 0xc0000409
Fault offset: 0x0003c7e
Failing process id: 0x4240
Failing application start time: 0x01da38ba0c74488a
Failing application path: C:\Program Files (x86)\Notepad++\updates\gup.exe
Failing module path: C:\Program Files (x86)\Notepad++\updates\gup.exe
Report id: 385452f51f223-42b7-86cf-8c41154d5e87
Failing package full name: Failing package-relative application ID:

```

| Time               | Application Name | Process Name      | Version      | Machine Name        |
|--------------------|------------------|-------------------|--------------|---------------------|
| 12/21/2023 2:53 AM | Unknown          | gup.exe           | 5.1.1.0      | ENG\ira-119-cvad030 |
| 12/21/2023 2:45 AM | Unknown          | LogonUI.exe       | 10.0.17763.1 | ENG\ira-119-cvad045 |
| 12/20/2023 9:50 PM | Unknown          | CDFControl.exe    | 3.10.0.14    | ENG\ira-119-cvad055 |
| 12/20/2023 6:31 PM | Unknown          | XenCenterMain.exe | 6.2.77796    | ENG\ira-119-cvad083 |

The failures are displayed as **Application Faults** or **Application Errors** based on their severity. The Application Faults tab displays failures associated with loss of functionality or data. Application Errors indicate problems that are not immediately relevant; they signify conditions that might cause future problems.

You can filter the failures based on **Published Application Name**, **Process Name** or **Delivery Group**, and **Time Period**. The table displays the fault or error code and a brief description of the failure. The detailed failure description is displayed as a tooltip.

**Note:**

The published application name is displayed as “Unknown” when the corresponding application name cannot be derived. This typically occurs when a launched application fails in a desktop session or when it fails due to an unhandled exception caused by a dependent executable.

By default, only faults of applications hosted on Multi-session OS VDAs are monitored. You can modify the monitoring settings through the Monitoring Group Policies: Enable monitoring of application failures, Enable monitoring of application failures on Single-session OS VDAs, and List of applications excluded from failure monitoring. For more information, see [Policies for application failure monitoring](#) in Monitoring policy settings.

The **Trends > Application Probe Results** page displays the results of application probing run in the site for the last 24 hours and 7 days. For more details on how to configure application probes, see [Application Probing](#).

## Troubleshoot machines

May 31, 2023

**Note:**

**Citrix Health Assistant** is a tool to troubleshoot configuration issues in unregistered VDAs. The tool automates several health checks to identify possible root causes for VDA registration failures and issues in session launch and time zone redirection configuration. The Knowledge Center article, [Citrix Health Assistant - Troubleshoot VDA Registration and Session Launch](#) contains the **Citrix Health Assistant** tool download and usage instructions.

The **Filters > Machines** view in the Director console displays the machines configured in the site. The Multi-session OS Machines tab includes the load evaluator index, which indicates the distribution of performance counters and tooltips of the session count if you hover over the link.

Click the **Failure Reason** column of a failed machine to get a detailed description of the failure and actions recommended to troubleshoot the failure. The failure reasons and the recommended actions for machine and connection failures are available in [Citrix Director failure reasons and troubleshooting](#).

Click the machine name link to go to the **Machine Details** page.

The Machine Details page lists the machine details, infrastructure details, and details of the hotfixes applied on the machine.

## Machine-based real-time resource utilization

The **Machine Utilization** panel displays graphs showing real-time utilization of CPU and memory. In addition, disk and GPU monitoring graphs are available for sites with Delivery Controllers and VDA versions **7.14** or later.

Disk monitoring graphs, average IOPS, and disk latency are important performance measurements that help you monitor and troubleshoot issues related to VDA disks. The Average IOPS graph displays the average number of reads and writes to a disk. Select **Disk Latency** to see a graph of the delay between a request for data and its return from the disk, measured in milliseconds.

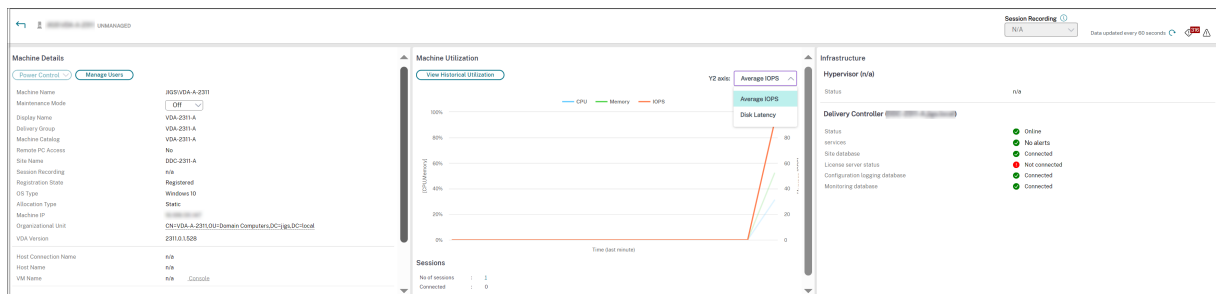

## GPU Utilization

Select **GPU Utilization** to see the percentage utilization of the GPU, the GPU memory, and of the Encoder and the Decoder to troubleshoot GPU-related issues on multi-session and single-session OS VDAs.

### Supported GPU versions:

- NVIDIA Tesla M60 GPUs running Display Driver version 369.17 or later. For more information, see [NVIDIA vGPU Software](#).
- AMD Radeon Instinct MI25 GPUs and AMD EPYC 7V12(Rome) CPUs. For more information, see [AMD Drivers and Support](#).

### Drivers:

The appropriate drivers or extensions must be installed on the VDAs.

- For NVIDIA GPUs, install GRID drivers manually or via extensions. For more information, see [NVIDIA vGPU Software](#).
  - Note that for NVIDIA, only GRID drivers are supported. CUDA drivers do not work with the NVadsA10 v5-series and are not supported.
  - For a sample process to install Nvidia Grid GPU drivers via extensions on Azure based machines, see [NVIDIA GRID drivers. NVIDIA GPU Driver Extension - Azure Windows VMs - Azure Virtual Machines](#).
  - For a sample process to install Nvidia Grid GPU drivers manually, see [Azure N-series NVIDIA GPU driver setup for Windows - Azure Virtual Machines](#).
- For AMD GPUs, install AMD graphics drivers manually or via extensions. For more information, see [AMD Drivers and Support](#).
  - For a sample process to install AMD GPU drivers via extensions on Azure based machines, see [AMD GPU Driver Extension - Azure Windows VMs - Azure Virtual Machines](#).
  - For a sample process to install AMD GPU drivers manually on Azure machines, see [Install AMD GPU drivers on N-series VMs running Windows](#).

### Usage Notes:

- The GPU Utilization graphs are available only for VDAs running 64-bit Windows.
- The VDAs must have HDX 3D Pro enabled to provide GPU acceleration. For more information, see [GPU acceleration for Windows Single-session OS](#) and [GPU acceleration for Windows Multi-session OS](#).
- When a VDA accesses more than one GPU, the utilization graph displays the average of the GPU metrics collected from the individual GPUs. The GPU metrics are collected for the entire VDA and not for individual processes.

- For AMD, encoder and decoder usage are not supported separately. Any encoding/ decoding workload using the GPU will be reported as the general 3D load on GPU usage.
- Ensure that you install the NVIDIA WMI during installation. This window is available only during manual installation.
- If drivers are installed but Director does not detect GPU
  - Check Task Manager. If drivers are installed properly, the GPU should show up in Task Manager.
  - Check if the machine is registered. Sometimes machines may take some time to be detected as online.
- If the GPU usage shows no activity in Director, make sure that the workload you are running is using the GPU. For graphics workloads, this can be enabled from Settings > System > Display > Graphics Settings > Choose the app to set preference. Make sure to turn on High Performance. Sometimes, Windows defaults to using the CPU for graphics workloads when this is set to system default or power saving, based on other settings.
- The data is updated every minute and the data visualization starts within a minute of selecting **GPU Utilization**.

## Machine-based historical resource utilization

In the **Machine Utilization** panel, click **View Historical Utilization** to view the historical usage of resources on the selected machine.

The utilization graphs include critical performance counters of CPU, memory, peak concurrent sessions, average IOPS, and disk latency.

### Note:

The Monitoring policy setting, **Enable Process Monitoring**, must be set to Allowed to collect, and display data in the Top 10 Processes table on the Historic Machine Utilization page. The collection is prohibited by default.

The CPU and memory utilization, average IOPS, and disk latency data is collected by default. You can disable the collection by using the **Enable Resource Monitoring** policy setting.



1. From the **Machine Utilization** panel in the **Machine Details** view, select **View Historical Utilization**.
2. In the **Historical Machine Utilization** page, set **Time Period** to view usage for the last 2 hours, 24 hours, 7 days, month, or year.

**Note:**

Average IOPS and disk latency usage data are available only for the last 24 hours, month, and year ending now. Custom end time is not supported.

3. Click **Apply** and select the required graphs.
4. Hover over different sections of the graph to view more information for the selected time period.

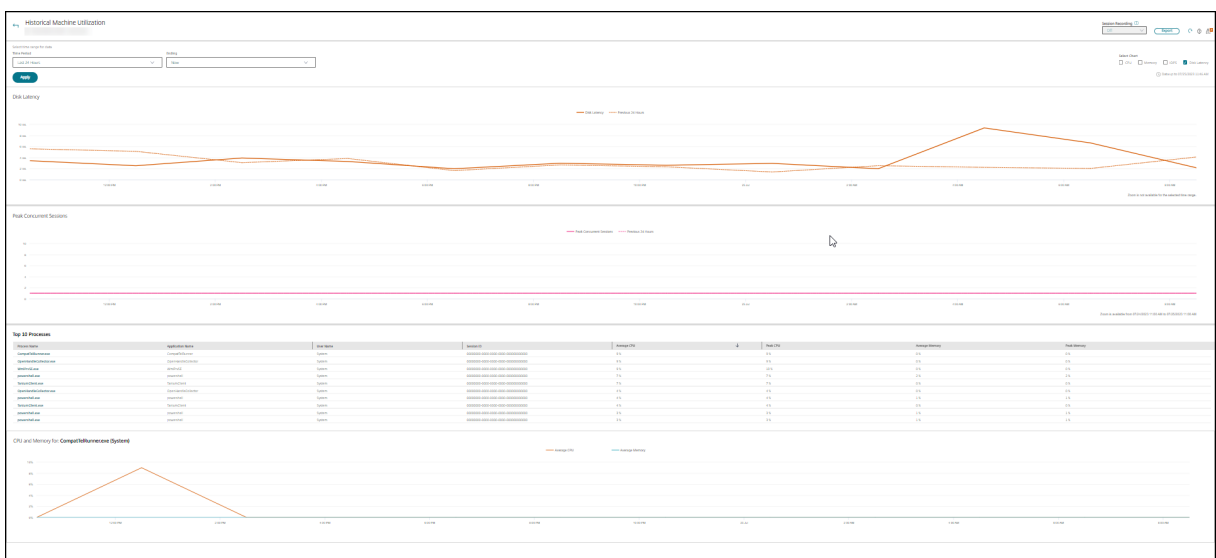

For example, if you select **Last 2 hours**, the baseline period is the 2 hours prior to the selected time range. View the CPU, memory, and session trend over the last 2 hours and the baseline time. If you select **Last month**, the baseline period is the previous month. Select to view the Average IOPS and disk latency over the last month and the baseline time.

1. Click **Export** to export the resource utilization data for the selected period. For more information, see [Export reports](#) section in Monitor Deployments.
2. Below the graphs, the table lists the top 10 processes based on CPU or memory utilization. You can sort by any of the columns, which show Application Name, User Name, Session ID, Average CPU, Peak CPU, Average Memory, and Peak Memory over the selected time range. The IOPS and Disk Latency columns cannot be sorted.

**Note:**

The session ID for system processes is displayed as “0000”.

3. To view the historical trend on the resource consumption of a particular process, drill into any of the Top 10 processes.

### Machine Console access

You can access the consoles of Single-session and Multi-session OS machines hosted on XenServer Version 7.3 and later directly from Director. This way, you don't require XenCenter to troubleshoot issues on XenServer hosted VDAs. For this feature to be available:

- Delivery Controller of Version 7.16 or later is required.
- The XenServer hosting the machine must be of Version 7.3 or later and must be accessible from the Director UI.

| Machine Details                                                                                                         |                                                                        |
|-------------------------------------------------------------------------------------------------------------------------|------------------------------------------------------------------------|
| <div style="display: flex; justify-content: space-between;"><span>Power Control ▾</span><span>Manage Users</span></div> |                                                                        |
| Machine Name                                                                                                            | P8J3U\VDA2                                                             |
| Maintenance Mode                                                                                                        | <input type="button" value="Off"/> ▾                                   |
| Display Name                                                                                                            | Hypervisor DG2 Desktop                                                 |
| Delivery Group                                                                                                          | Hypervisor DG2 Desktop                                                 |
| Machine Catalog                                                                                                         | Hypervisor Desktop MC2                                                 |
| Remote PC Access                                                                                                        | No                                                                     |
| Site Name                                                                                                               | BVT_DB                                                                 |
| Registration State                                                                                                      | Registered                                                             |
| OS Type                                                                                                                 | Windows 10                                                             |
| Allocation Type                                                                                                         | Static                                                                 |
| Machine IP                                                                                                              | 10.108.16.217                                                          |
| Organizational Unit                                                                                                     | <u>CN=VDA2,CN=Computers,DC=bvt,DC=local</u>                            |
| VDA Version                                                                                                             | 2305.0.1.117                                                           |
| <hr/>                                                                                                                   |                                                                        |
| Host Connection Name                                                                                                    | simranHypervisor1                                                      |
| Host Name                                                                                                               | R2A11-C02-B01                                                          |
| VM Name                                                                                                                 | VDA2 <span style="border: 1px solid red; padding: 2px;">Console</span> |
| <hr/>                                                                                                                   |                                                                        |
| vCPU                                                                                                                    | 2                                                                      |
| Memory                                                                                                                  | 4088 MB                                                                |
| Hard Disk                                                                                                               | 100 GB                                                                 |
| <hr/>                                                                                                                   |                                                                        |
| Average Disk per second transfer                                                                                        | 0.020                                                                  |
| Current disk queue length                                                                                               | 3                                                                      |

To troubleshoot a machine, click the **Console** link in the corresponding Machine Details panel. After authentication of the host credentials you provide, the machine console opens in a separate tab using noVNC, a web-based VNC client. You now have keyboard and mouse access the console.

**Note:**

- This feature is not supported on Internet Explorer 11.
- If the mouse pointer on the machine console is misaligned, see [CTX230727](#) for steps to fix the issue.
- Director launches console access in a new tab, ensure that your browser settings allow pop-ups.
- For security reasons, Citrix recommends that you install SSL certificates on your browser.



## Microsoft RDS license health

You can view the status of the Microsoft RDS license in the Machine Details panel in the **Machine Details** and the **User Details** page for Multi-session OS machines.

The screenshot shows the 'Machine Details' panel with the following configuration and performance metrics:

|                            |                                             |
|----------------------------|---------------------------------------------|
| Machine Name               | WANMQ\AWTSVDA-0001                          |
| Maintenance Mode           | Off                                         |
| Display Name               | psc server dg                               |
| Delivery Group             | psc server dg                               |
| Machine Catalog            | psc server vda                              |
| Remote PC Access           | No                                          |
| Site Name                  | cloudxdsite                                 |
| Windows Connection Setting | LogonEnabled                                |
| Registration State         | Registered                                  |
| OS Type                    | Windows 2016                                |
| Allocation Type            | Random                                      |
| Machine IP                 | 10.108.92.187                               |
| Organizational Unit        | CN=AWTSVDA-0001,CN=Computers,DC=xd,DC=local |
| VDA Version                | 2206.0.0.34067                              |

|                      |                             |
|----------------------|-----------------------------|
| Host Connection Name | n/a                         |
| Host Name            | n/a                         |
| VM Name              | n/a <a href="#">Console</a> |

|           |         |
|-----------|---------|
| vCPU      | 2       |
| Memory    | 4088 MB |
| Hard Disk | 200 GB  |

|                                  |                         |
|----------------------------------|-------------------------|
| Average Disk per second transfer |                         |
| Current disk queue length        |                         |
| Microsoft RDS License            | Not configured properly |
| Load Evaluator Index             | 0.80%                   |

A tooltip message is displayed: "An RDS licensing type is not configured."

One of the following messages is displayed:

- License available
- Not configured properly (warning)
- License error (error)
- Incompatible VDA version (error)

**Note:**

The RDS license health status for machines under grace period with valid license displays a **Li-**

**License available** message in green. Renew your license before they expire.

For warning and error messages, hover over the info icon to view additional information as given in the following table.

| Message Type | Messages in Director                                                                                                                                                |
|--------------|---------------------------------------------------------------------------------------------------------------------------------------------------------------------|
| Error        | Available for VDAs version 7.16 and later.                                                                                                                          |
| Error        | New RDS connections are not allowed.                                                                                                                                |
| Error        | RDS licensing has exceeded its grace period.                                                                                                                        |
| Error        | A License Server is not configured for the required OS level with the Per Device Client Access licensing type.                                                      |
| Error        | The configured License Server is incompatible with the RDS Host OS level with the Per Device Client Access licensing type.                                          |
| Warning      | Personal Terminal Server is not a valid RDS licensing type in a Citrix Virtual Apps and Desktops deployment.                                                        |
| Warning      | Remote Desktop for Administration is not a valid licensing type in a Citrix Virtual Apps and Desktops deployment.                                                   |
| Warning      | An RDS licensing type is not configured.                                                                                                                            |
| Warning      | The Domain Controller or License Server is unreachable with the Per User Client Access RDS licensing type.                                                          |
| Warning      | With the Per Device Client Access licensing type, the Client Device license cannot be determined since the license server for the required OS level is unreachable. |

**Note:**

This feature is applicable only for Microsoft RDS CAL (Client Access License).

## Troubleshoot user issues

March 22, 2024

Use the Director's **Help Desk** view (**Activity Manager** page) to view information about the user or session:

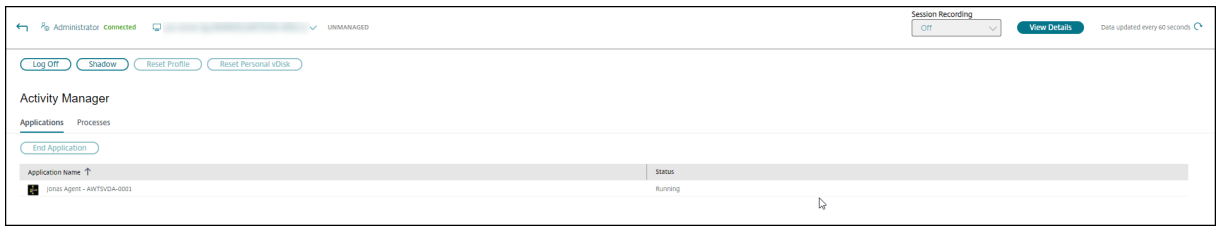

Clicking **View Details** from the Activity Manager for a user opens the **User Details** page.

Clicking **View Details** from the Activity Manager for an endpoint opens the **Endpoint Details** page.

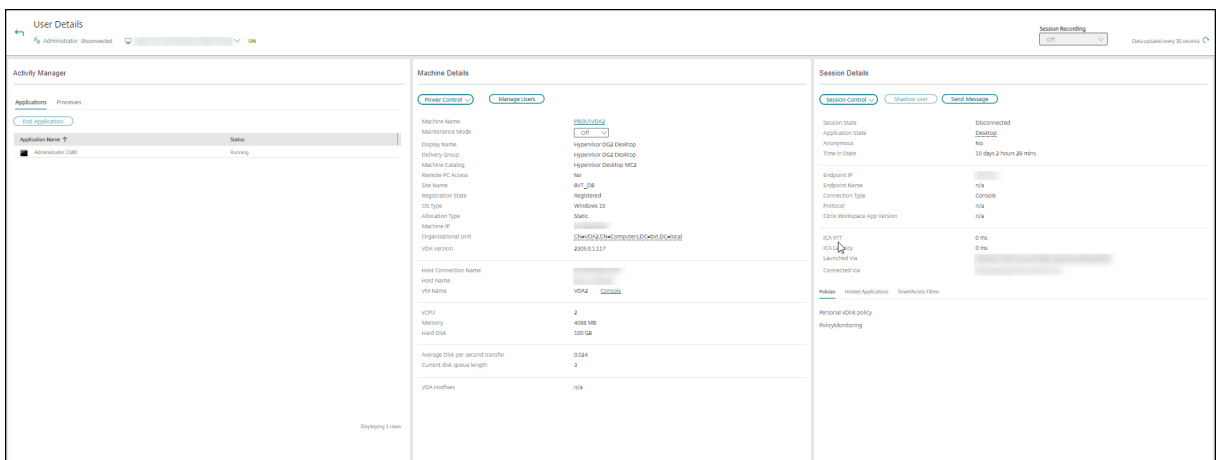

## Session Selector

If the user has started several sessions, the session selector helps select a session.

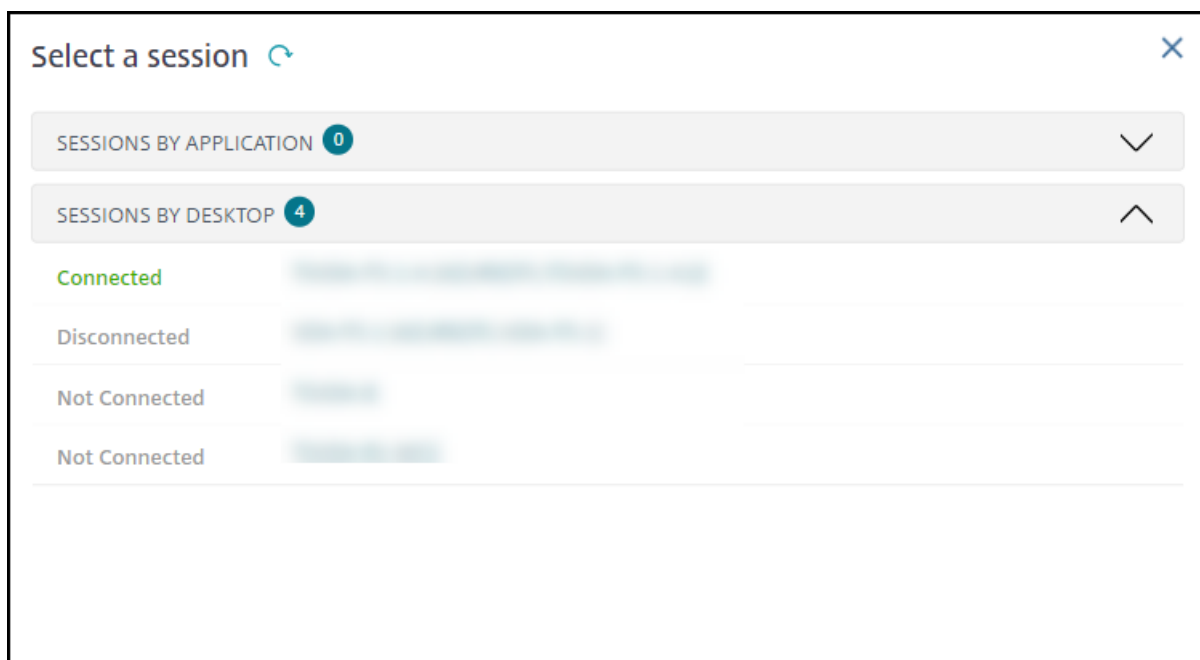

Choose a session to view the details.

- Check details about the session, user's sign in experience, session startup, connection, and applications.
- you can Shadow the user's machine.
- Record the ICA session.

## Microsoft Teams optimization status

Director displays the Microsoft Teams optimization status for HDX sessions in the **User Details** page > **Session Details** panel > **MS Teams Optimization** field. Microsoft Teams being optimized is critical for the better user experience such as clear audio and video. Visibility of the Microsoft Teams optimization status is useful in reducing the time required to resolve tickets and helps administrators identify important metrics during troubleshooting.

### Note:

- Citrix Director supports only if you're using Microsoft Teams before version 2.0.
- Citrix Monitor supports Microsoft Teams version 2.1 or earlier.

Prerequisites:

- VDA are running version 2311 and later.
- Citrix Workspace app versions supported are listed in [Optimization for Microsoft Teams](#).
- Microsoft Teams runs as a published app or inside a published desktop.
- Crucial services such as the Citrix HDX HTML5 Video Redirection Service, are running.

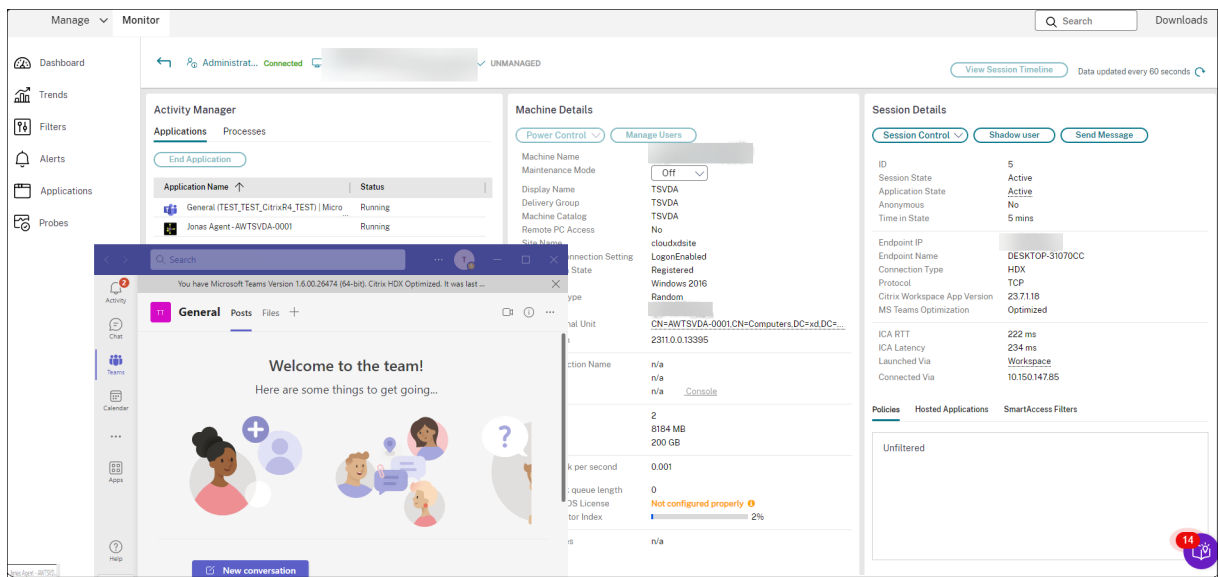

If the Microsoft Teams isn't optimized, the tooltip provides a link to an external troubleshooting live article from HDX containing tips to optimize Microsoft Teams. [Troubleshooting HDX Optimization](#).

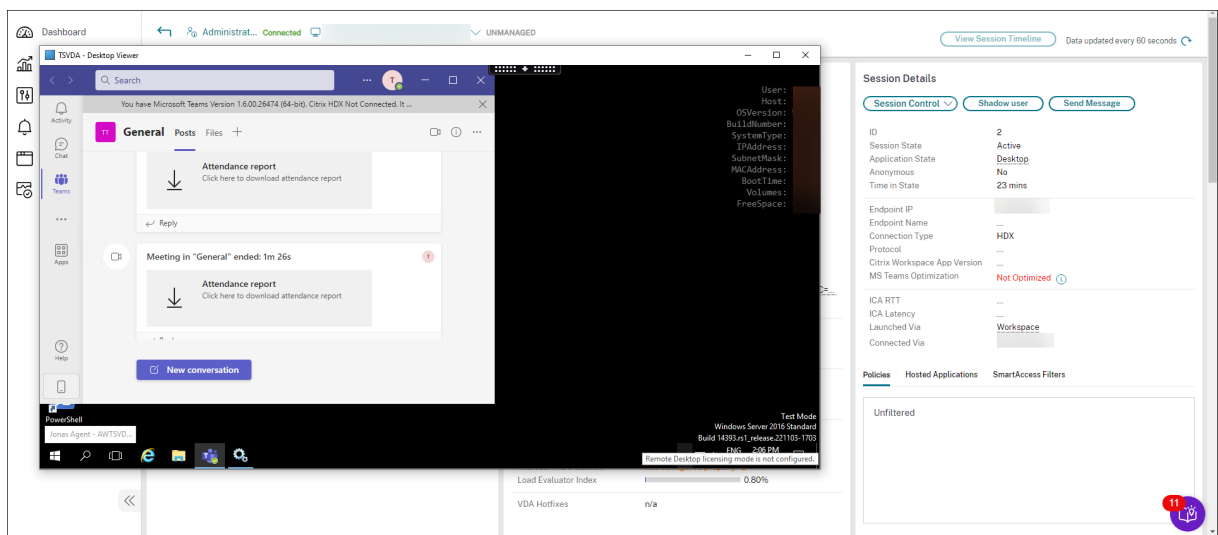

## Troubleshooting tips

Troubleshoot the issue with the recommended actions in the following table, and, if needed, escalate the issue to the appropriate administrator.

### User issue

### Suggestions

Logon takes a long time or fails intermittently or repeatedly

[Diagnose user logon issues](#)

---

| User issue                                                              | Suggestions                                         |
|-------------------------------------------------------------------------|-----------------------------------------------------|
| Session startup takes a long time or fails intermittently or repeatedly | <a href="#">Diagnose session startup issues</a>     |
| Session response is slow or not responding                              | <a href="#">Diagnose session performance issues</a> |
| Application is slow or does not respond                                 | <a href="#">Resolve application failures</a>        |
| Connection failed                                                       | <a href="#">Restore desktop connections</a>         |
| Session is slow or not responding                                       | <a href="#">Restore sessions</a>                    |
| Record sessions                                                         | <a href="#">Record sessions</a>                     |
| Video is slow or poor quality                                           | <a href="#">Run HDX channel system reports</a>      |

---

**Note:**

To make sure that the machine isn't in maintenance mode, from the User Details view, review the Machine Details panel.

## Session Logon

The **User Details** view > **Session Logon** tab displays a comprehensive view of the session logon process. The tab contains the Logon Duration phases chart with the various logon phases plotted. Use this data to troubleshoot user logon issues. For more information, see [Diagnose user logon issues](#).

## Session Performance

The **Session Performance** tab has enhanced troubleshooting workflows starting with the ability to correlate real-time metrics in identifying issues within user sessions. The **Session Topology** panel provides a visual representation of the in-session path for connected HDX sessions. The **Performance Metrics** panel provides trends for the session metrics like ICARTT, ICA Latency, Frames Per Second, Output Bandwidth Available, and Output Bandwidth Consumed help indicate how these metrics have performed over time. For more information, see [Diagnose session performance issues](#).

## Search tips

When you type the user's name in a Search field, Director searches for users in the Active Directory for users across all sites that are configured to support Director.

When you type a multiuser machine name in a Search field, Director displays the Machine Details for the specified machine.

When you type an endpoint name in a Search field, Director uses the unauthenticated (anonymous) and authenticated sessions that are connected to a specific endpoint. This search enables troubleshooting unauthenticated sessions. Ensure that endpoint names are unique to enable troubleshooting of unauthenticated sessions.

The search results also include users who are not currently using or assigned to a machine.

- Searches aren't case-sensitive.
- Partial entries produce a list of possible matches.
- After you type a few letters of a two-part name, separated by a space, the results include matches for both strings. The examples for two-part names are user name, family name and first name, or display name. For example, if you type jo rob, the results might include strings such as "John Robertson" or "Robert Jones".

To return to the landing page, click the **Director logo**.

## Access Citrix Insight Services

You can access [Citrix Insight Services](#) (CIS) from the **User** drop-down list in Director to access extra diagnostic insights. The data available in the CIS comes from sources including Call Home and Citrix Scout.

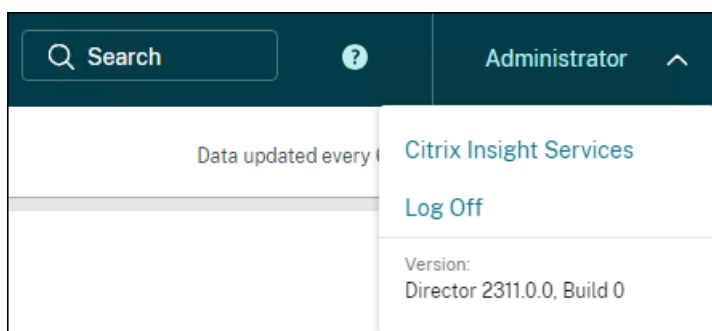

## Upload troubleshooting information to Citrix Technical Support

Run Citrix Scout from a single Delivery Controller or VDA to capture key data points and Citrix Diagnostics Facility (CDF) traces to troubleshoot selected computers. Scout offers the ability to securely upload the data to the CIS platform to assist Citrix Technical Support on troubleshooting. Citrix Technical Support uses the CIS platform to reduce the time to resolve customer-reported issues.

Scout is installed with Citrix Virtual Apps and Desktops components. Depending on the version of Windows, Scout appears in the **Windows Start** menu or Start Screen when you install or upgrade to Citrix Virtual Apps and Desktops.

To start Scout, from the Start menu or Start Screen, select **Citrix > Citrix Scout**.

For information on using and configuring the Scout, and for an FAQ, see [CTX130147](#).

## Diagnose session startup issues

March 29, 2022

In addition to the logon process phases mentioned in the [Diagnose user logon issues](#) section, Director displays the session startup duration. This is divided into Workspace App Session Startup and VDA Session Startup duration on the **User Details** page and **Machine Details** pages. These two durations further contain individual phases whose startup durations are also displayed. This data helps you to understand and troubleshoot high session startup duration. Further, the time duration for each phase involved in the session startup helps in troubleshooting issues associated with individual phases. For example, if the Drive Mapping time is high, you can check to see whether all the valid drives are mapped correctly in the GPO or script. This feature is available on Delivery Controller version 7 1906 and later and VDAs 1903 and later.

### Prerequisites

Ensure that the following prerequisites are met for session startup duration data to be displayed:

- Delivery Controller 7 1906 or later.
- VDA 1903 or later.
- Citrix End User Experience Monitoring (EUEM) service must be running on the VDA.

### Limitations

The following limitations apply when Director displays the session startup duration data.

- Session startup duration is available only for HDX sessions.
- For session launches from iOS and Android OS, only VDA Startup Duration is available.
- IFDCD is available only when Workspace App is detected while launching from a browser.
- For session launches from macOS, IFDCD is available for Workspace App 1902 or later only.
- For session launches from Windows OS, IFDCD is available for Workspace app 1902 and later. For earlier versions, IFDCD is displayed for only app launches from the browser with Workspace app detected.



**Notes:**

- If you face issues in the sessions startup duration display after the prerequisites are met, view the Director server and VDA logs as described in [CTX130320](#).  
For shared sessions (multiple applications launched in the same session), the Workspace App Startup metrics are displayed for the latest connection execution or the latest application launch.
- Some metrics in VDA Session Startup are not applicable on reconnects. In such cases, a message is displayed.

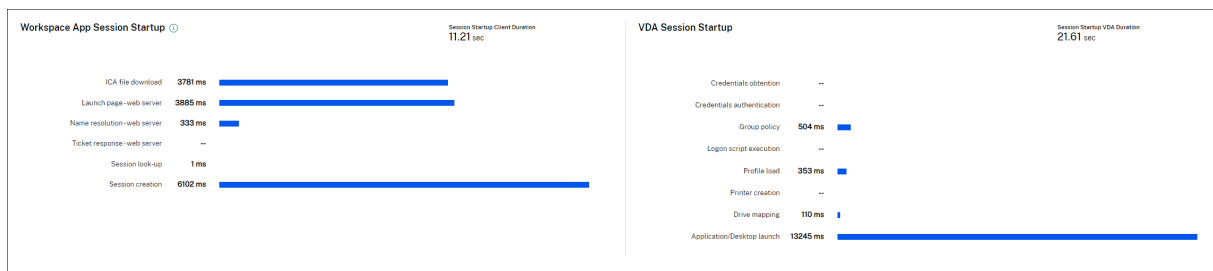
**Workspace App session startup phases****Session Startup Client Duration (SSCD)**

When this metric is high, it indicates a client-side issue that is causing long start times. Review subsequent metrics to determine the probable root cause of the issue. SSCD starts as close as possible to the time of the request (mouse click). It ends when the ICA connection between the client device and VDA has been established. In the case of a shared session, this duration is much smaller, as much of the setup costs associated with the creation of a new connection to the server are not incurred. At the following level down, there are several detailed metrics available.

**ICA File Download Duration (IFDCD)**

This is the time taken for the client to download the ICA file from the server. The overall process is as follows:

1. The user clicks a resource (application or desktop) in the Workspace Application.
2. A request from the user is sent to the StoreFront through the Citrix Gateway (if configured), which sends the request to the Delivery Controller.
3. The Delivery Controller finds an available machine for the request and sends the machine information and other details to StoreFront. Also, StoreFront requests and receives a one-time ticket from the Secure Ticket Authority.
4. StoreFront generates an ICA File and sends it to the user via Citrix Gateway (if configured).

IFDCD represents the time it takes for the complete process (steps 1–4). The IFDCD duration stops counting when the client receives the ICA file.

LPWD is the StoreFront component of the process.

If IFDCD is high (but LPWD is normal), the server-side processing of the launch was successful, but there were communication issues between the client device and the StoreFront. This results from network issues between the two machines. So you can troubleshoot potential network issues first.

### **Launch Page Web Server Duration (LPWD)**

This is the time taken to process the launch page (launch.aspx) on the StoreFront. If LPWD is high, there might be a bottleneck on the StoreFront.

Possible causes include:

- High load on the StoreFront. Try to identify the cause of the slowdown by checking the Internet Information Services (IIS) logs and monitoring tools, Task Manager, Performance Monitor and so on.
- StoreFront is having issues communicating with other components such as the Delivery Controller. Check if the network connection between StoreFront and Delivery Controller is slow or some Delivery Controllers are down or overloaded.

### **Name Resolution Web Server Duration (NRWD)**

This is the time taken by the Delivery Controller to resolve the name of a published application/desktop to a VDA Machine IP Address.

When this metric is high, it indicates that the Delivery Controller is taking a long time to resolve the name of a published application to an IP address.

Possible causes include a problem on the client, issues with the Delivery Controller, such as the Delivery Controller being overloaded, or a problem with the network link between them.

### **Ticket Response Web Server Duration (TRWD)**

This duration indicates the time it takes to get a ticket (if necessary) from the Secure Ticket Authority (STA) Server or Delivery Controller. When this duration is high, it indicates that the STA server or the Delivery Controller are overloaded.

### **Session Look-up Client Duration (SLCD)**

This duration represents the time taken to query every session to host the requested published application. The check is performed on the client to determine whether an existing session can handle the application launch request. The method used depends on whether the session is new or shared.

### **Session Creation Client Duration (SCCD)**

This duration represents the time taken to create a session, from the moment wfica32.exe (or a similar equivalent file) is launched to the time when the connection is established.

## **VDA session startup phases**

### **Session Startup VDA Duration (SSVD)**

This duration is the high-level server-side connection start-up metric that encompasses the time VDA takes to perform the entire start-up operation. When this metric is high, it indicates that there is a VDA issue increasing session start times. This includes the time spent on the VDA performing the entire start-up operation.

### **Credentials Obtention VDA Duration (COVD)**

The time taken for the VDA to obtain the user credentials.

This duration can increase artificially if a user fails to provide credentials in a timely manner. So, it is not included in the VDA Startup Duration. This time is likely to be a significant only if manual login is being used and the server side credentials dialog is displayed (or if a legal notice is displayed before login commences).

### **Credentials Authentication VDA Duration (CAVD)**

This is the time taken by the VDA to authenticate the user's credentials against the authentication provider. They can be Kerberos, Active Directory, or a Security Support Provider Interface (SSPI).

### **Group Policy VDA Duration (GPVD)**

This duration is the time taken to apply group policy objects during logon.

### **Login Script Execution VDA Duration (LSVD)**

This is the time taken by the VDA to run the user's login scripts.

Consider making asynchronous the user or group's login scripts. Consider optimizing any application compatibility scripts or use environment variables instead.

### **Profile Load VDA Duration (PLVD)**

This is the time taken by the VDA to load the user's profile.

If this duration is high, consider your User Profile configuration. Roaming profile size and location contribute to slow session starts. When a user logs on to a session where Terminal Services roaming profiles and home folders are enabled, the roaming profile contents and access to that folder are mapped during the logon. This takes extra resources. Sometimes, this can consume significant amount of the CPU usage. Consider using the **Terminal Services home** folders with redirected personal folders to mitigate this problem. In general, consider using Citrix Profile Management to manage user profiles in Citrix environments. If you are using Citrix Profile Management and have slow logon times, check if your antivirus software is blocking the Citrix Profile Management tool.

### **Printer Creation VDA Duration (PCVD)**

This is the time taken for the VDA to map the user's client printers synchronously. If the configuration is set for printer creation to be performed asynchronously, the value is not recorded for PCVD as it does not impact completion of the session startup.

Excessive time spent in mapping printers is often the result of the printer auto creation policy settings. The number of printers added locally on the users' client devices and your printing configuration can directly affect your session start times. When a session starts, Citrix Virtual Apps and Desktops has to create every locally mapped printer on the client device. Consider reconfiguring your printing policies to reduce the number of printers that get created, specifically when users have many local printers. To do this, edit the Printer Auto creation policy in Delivery Controller and Citrix Virtual Apps and Desktops.

### **Drive Mapping VDA Duration (DMVD)**

This is the time taken by the VDA to map the user's client drives, devices, and ports.

Ensure that your base policies include settings to disable unused virtual channels. For example, audio or COM port mapping, to optimize the ICA protocol and improve overall session performance.

### **Application/Desktop Launch VDA Duration (ALVD/DLVD)**

This phase is a combination of Userinit and Shell duration. When a user logs on to a Windows machine, winlogon runs userinit.exe. Userinit.exe runs logon scripts, re-establishes network connections, and then starts Explorer.exe. Userinit represents the duration between the start of userinit.exe to the start of the user interface for the virtual desktop or application. The Shell duration is the time between the initialization of the user interface to the time the user receives keyboard and mouse control.

### **Session Creation VDA Duration (SCVD)**

This time includes any miscellaneous delay in session creation time on VDA.

## **Diagnose user logon issues**

November 28, 2023

The **User Details** view > **Session Logon** tab displays a comprehensive view of the session logon process. Use this data to troubleshoot user logon issues.

Logon duration is measured only for initial connections to a desktop or app using HDX. This data does not include users trying to connect with Remote Desktop Protocol or reconnect from disconnected sessions. Specifically, logon duration is not measured when a user initially connects using a non-HDX protocol and reconnects using HDX.

As users log on to Citrix Virtual Apps and Desktops, the Monitor Service tracks the phases of the logon process. The phases begin from the time the user connects from Citrix Workspace app to the time when the app or desktop is ready to use.

The **Session Logon** tab contains the Logon Duration phases chart with the various logon phases plotted. The Logon Duration represents the time spent establishing the connection and obtaining an app or a desktop from Delivery Controller and the time spent to authenticate and log on to a virtual app or desktop. The duration information is presented in seconds (or fractions of seconds).

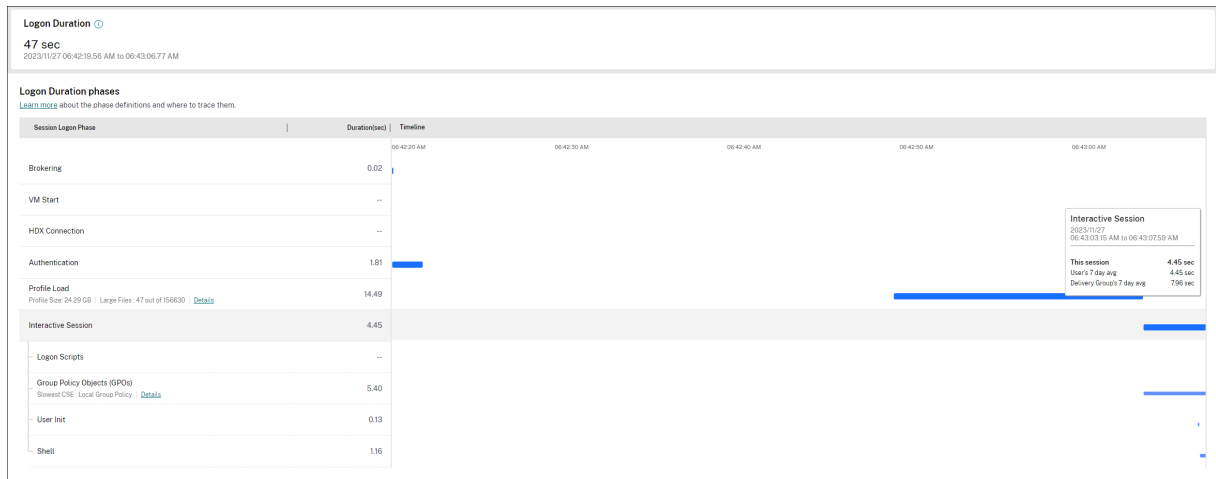

The Logon Duration phases chart provides a clear view of different logon phases and their start and end times. The chart shows the overlapping of the individual logon phases. The total logon time might not be the sum of the individual logon phase durations. This is because the individual phases might overlap and not all logon phases are a part of this representation. Also, certain phases might extend even after the user starts interacting with the virtual app or desktop, and this duration is not measured as part of the overall logon duration.

Use this view to identify specific logon phases causing a delayed session launch. The definition for each logon phase and the event source from where you can trace information helps further troubleshooting. Hovering on the chart gives a tooltip containing the phase duration for the current session as well as the user's 7-day average and the delivery group's 7-day average. This information helps compare the current session logon duration with the 7-day average values. You can further drilldown into subphase measurements in the case of GPO and Profile Details. This visualization helps understand and troubleshoot logon duration-related issues easily.

## Prerequisites

Ensure that the following prerequisites are met for logon duration data and drilldowns to appear:

1. Install **Citrix User Profile Manager** and **Citrix User Profile Manager WMI Plugin** on the VDA.
2. Ensure that the Citrix Profile Management Service is running.
3. For XenApp and XenDesktop sites 7.15 and earlier, disable the GPO setting, **Do not process the legacy run list**.
4. Audit process tracking must be enabled for Interactive Session drilldown.
5. For GPO drilldown, increase the size of Group Policy operational logs.

### Notes:

- Logon duration is supported only on the default Windows shell (explorer.exe) and not on

custom shells.

- Logon duration for Remote PC Access is available only when **Citrix User Profile Manager** and the **Citrix User Profile Manager WMI Plugin** are installed as extra components during Remote PC Access installation. For more information, see Step 4 in [Remote PC Access configuration and sequence considerations](#).

## Steps to troubleshoot user logon issues

1. From the **User Details** view > **Session Logon** tab, troubleshoot the logon state using the Logon Duration chart.
  - If the user is logging on, the view reflects the process of logging on.
  - If the user is logged on, the Logon Duration panel displays the time it took for the user to log on to the current session.
2. Examine the phases of the logon process.

## Logon process phases

### Brokering

Time taken to decide which desktop to assign to the user.

### VM start

If the session requires a machine start, VM start is the time taken to start the virtual machine.

### HDX connection

Time taken to complete the steps required in setting up the HDX connection from the client to the virtual machine.

### Authentication

Time taken to complete authentication to the remote session.

## GPOs

If Group Policy settings are enabled on the virtual machines, this is the time taken to apply group policy objects during logon. The drill-down of the time taken to apply each policy as per the CSEs (Clients-Side Extension) is available as a tooltip when you hover on the GPO bar.

| Client side extension name | Status | Time (sec) | GPO                |
|----------------------------|--------|------------|--------------------|
| Citrix Group Policy        | Passed | 1.55       | Local Group Policy |
| Citrix Profile Management  | Passed | 0.16       | None               |

The time durations above represent the CSE (Clients-Side Extension) processing time only. They do not add up to the total time duration of the GPOs phase.

Copy Table

Click **Details** to see a table with the policy status, and the corresponding GPO name. The time durations in the drilldown represent the CSE processing time only and do not add up to the total GPO time. You can copy the drill-down table for further troubleshooting or use in reports. The GPO time for the policies is retrieved from Event Viewer logs. The logs can get overwritten depending on the memory allocated for the operational logs (default size is 4 MB). For more information about increasing the log size for the operational logs, see the Microsoft TechNet article [Configuring the Event Logs](#).

## Logon scripts

If logon scripts are configured for the session, this is the time taken for the logon scripts to be run.

## Profile load

If profile settings are configured for the user or the virtual machine, this is the time taken for the profile to load.

If Citrix Profile Management is configured, the Profile Load bar includes the time taken by Citrix Profile Management to process user profiles. This information helps administrators to troubleshoot high profile processing duration issues. When Profile Management is configured, the Profile Load bar displays an increased duration. This increase is caused by this enhancement and does not reflect a performance degradation. This enhancement is available on VDAs 1903 or later.

Hovering over the Profile Load bar displays a tooltip showing the user profile details for the current session.



**Profile details**

Profile Size  
**24.29 GB**

| Folder Name  | Size     | Number Of Files |
|--------------|----------|-----------------|
| .buck        | 7.8 GB   | 57965           |
| .nugget      | 5.44 GB  | 34449           |
| Downloads    | 4.93 GB  | 1588            |
| AppData      | 3.36 GB  | 23135           |
| ivy2         | 78779 MB | 4599            |
| hadoop-2.8.3 | 629.2 MB | 21064           |

Large Files (Size > 50Mb)  
**47**

Total Files  
**156630**

**Warning:** Larger profile sizes lead to higher loading times. We recommend:

- Resetting the user profile
- Removing unwanted files
- Use profile streaming

[Reset Profile](#)

Click **Details** to drilldown further into each individual folder in the profile root folder (for instance, C:/Users/username), its size, and the number of files (including files inside nested folders).

**Profile Drilldown**

Profile details view

- Number Of Files: 128
- Profile Size: 2.89 GB
- Number of large files (>50MB): 1

Folder details

| Folder Name           | Size      | Number of Files |
|-----------------------|-----------|-----------------|
| Desktop               | 2.89 GB   | 2               |
| LOAD_C472F92B-A11D... | 2.94 MB   | 7               |
| AppData               | 208.02 KB | 97              |
| Links                 | 2.01 KB   | 3               |
| Searches              | 1.83 KB   | 4               |

Note:  
User Profile can be Reset in the Personalization Panel

61 sec Logon Duration

50% Profile Load on Disk, 50% Interactive Session

Profile drilldown is available on Delivery Controller version 7 1811 or later and VDAs 1811 or later. Using the profile drilldown information, you can resolve issues involving a high profile load time. You can:

- Reset the user profile
- Optimize the profile by removing unwanted large files
- Reduce the number of files to reduce the network load
- Use profile streaming

By default, all folders in the profile root are displayed in the drilldown. To hide folder visibility, edit the following registry value on the VDA machine:

#### Warning:

Adding and editing the registry incorrectly can cause serious problems that might require you to reinstall your operating system. Citrix does not guarantee that problems resulting from the incorrect use of Registry Editor can be solved. Use Registry Editor at your own risk. Be sure to back up the registry before you edit it.

1. On the VDA, add a new registry value **ProfileFoldersNameHidden** at HKEY\_LOCAL\_MACHINE\Software\Citrix

2. Set the value to 1. This value must be a DWORD (32-bit) value. Folder names visibility is now disabled.
3. To make the folder names visible again, set the value to 0.

**Note:**

You can use GPO or PowerShell commands to apply the registry value change on multiple machines. For more information about using GPO to deploy registry changes, see the [blog](#).

### Additional information

- Profile drilldown does not consider redirected folders.
- The NTUser.dat files in the root folder might not be visible to end users. However, they are included in the profile drilldown and displayed in the list of files in **Root Folder**.
- Certain hidden files in the AppData folder are not included in the Profile drilldown.
- The number of files and profile size data might not match with the data in the Personalization panel due to certain Windows limitations.

### Interactive Session

Interactive Session is the time taken to “hand off” keyboard and mouse control to the user after the user profile has been loaded. It is normally the longest duration out of all the phases of the logon process and is calculated as **Interactive Session duration = Desktop Ready Event Timestamp (EventId 1000 on VDA) - User Profile Loaded Event Timestamp (EventId 2 on VDA)**. Interactive Session has three subphases: Pre-userinit, Userinit, and Shell. Hover over Interactive Session to see a tooltip showing the following:

- subphases
- time taken for each subphase
- total cumulative time delay between these subphases

**Note:**

This feature is available on VDAs 1811 and later. If you have launched sessions on sites earlier than 7.18 and then upgraded to 7.18 or later, a ‘Drilldown unavailable due to server error’ message is displayed. However, if you have launched sessions after upgrading, no error message is displayed.

To view the time duration of each subphase, enable Audit process tracking on the VM (VDA). When the Audit process tracking is disabled (default), the time duration of Pre-userinit and the combined time duration of Userinit and Shell are displayed. You can enable Audit process tracking through a Group Policy Object (GPO) as follows:

1. Create a GPO and edit it using the GPO editor.
2. Go to **Computer Configuration > Windows Settings > Security Settings > Local Policies > Audit Policy**.
3. On the right pane, double-click **Audit process tracking**.
4. Select **Success** and click OK.
5. Apply this GPO to the required VDAs or Group.

For more information about Audit process tracking and enabling or disabling it, see [Audit process tracking](#) in the Microsoft documentation.

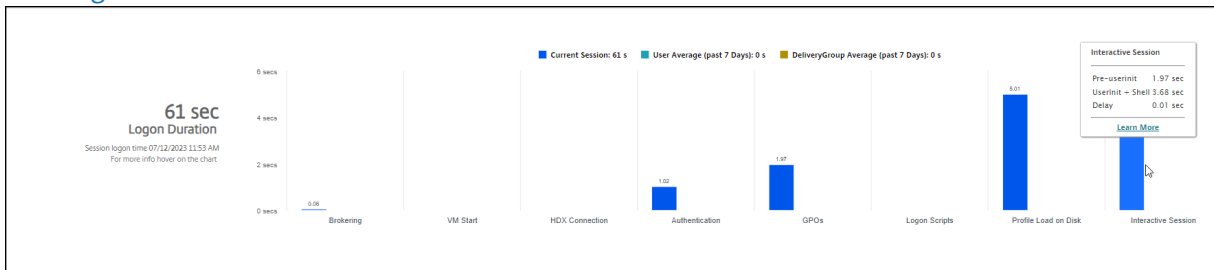

Logon Duration panel in the User Details view.

- **Interactive Session –Pre-userinit:** The segment of Interactive Session which overlaps with Group Policy Objects and scripts. This subphase can be reduced by optimizing the GPOs and scripts.
- **Interactive Session –Userinit:** When a user logs on to a Windows machine, Winlogon runs userinit.exe. Userinit.exe runs logon scripts, re-establishes network connections, and then starts Explorer.exe, the Windows user interface. This subphase of Interactive Session represents the duration between the start of Userinit.exe to the start of the user interface for the virtual desktop or application.
- **Interactive Session –Shell:** In the previous phase, Userinit starts the initialization of Windows user interface. The Shell subphase captures the duration between the initialization of the user interface to the time the user receives keyboard and mouse control.
- **Delay:** This is the cumulative time delay between the **Pre-userinit and Userinit** subphases and the **Userinit and Shell** subphases.

The total logon time is not an exact sum of these phases. For example, some phases occur in parallel, and in some phases, more processing occurs that can result in a longer logon duration than the sum. The total logon time does not include the ICA idle time that is the time between the ICA file download and the ICA file launch for an application.

To enable the automatic opening of the ICA file upon application launch, configure your browser for automatic ICA file launch upon download of an ICA file. For more information, see [CTX804493](#).

**Note:**

The Logon Duration graph shows the logon phases in seconds. Any duration values below one second are displayed as subsecond values. The values above one second are rounded to the

nearest 0.5 second. The graph has been designed to show the highest y-axis value as 200 seconds. Any value greater than 200 seconds is shown with the actual value displayed above the bar.

## Troubleshooting tips

To identify unusual or unexpected values in the graph, compare the amount of time taken in each phase of the current session with the average duration for this user for the last seven days, and the average duration for all users in this delivery group for the last seven days.

Escalate as needed. For example, if the VM startup is slow, the issue might be in the hypervisor, so you can escalate it to the hypervisor administrator. Or, if the brokering time is slow, you can escalate the issue to the site administrator to check the load balancing on the Delivery Controller.

Examine unusual differences, including:

- Missing (current) logon bars
- Major discrepancy between the current duration and this user's average duration. Causes include:
  - A new application was installed.
  - An operating system update occurred.
  - Configuration changes were made.
  - Profile size of the user is high. In this case, the Profile Load is high.
- Major discrepancy between the user's logon numbers (current and average duration) and the delivery group average duration.

If needed, click **Restart** to observe the user's logon process to troubleshoot issues, such as VM Start or Brokering.

## Diagnose Session Performance issues

February 20, 2024

The **Session Performance** tab on the User Details Page has enhanced troubleshooting workflows to help identify issues within HDX user sessions. The Session Topology and Performance Metrics panels help correlate the component view and multiple performance metrics of a session in a single view and reduces the mean time for resolution of session experience issues.

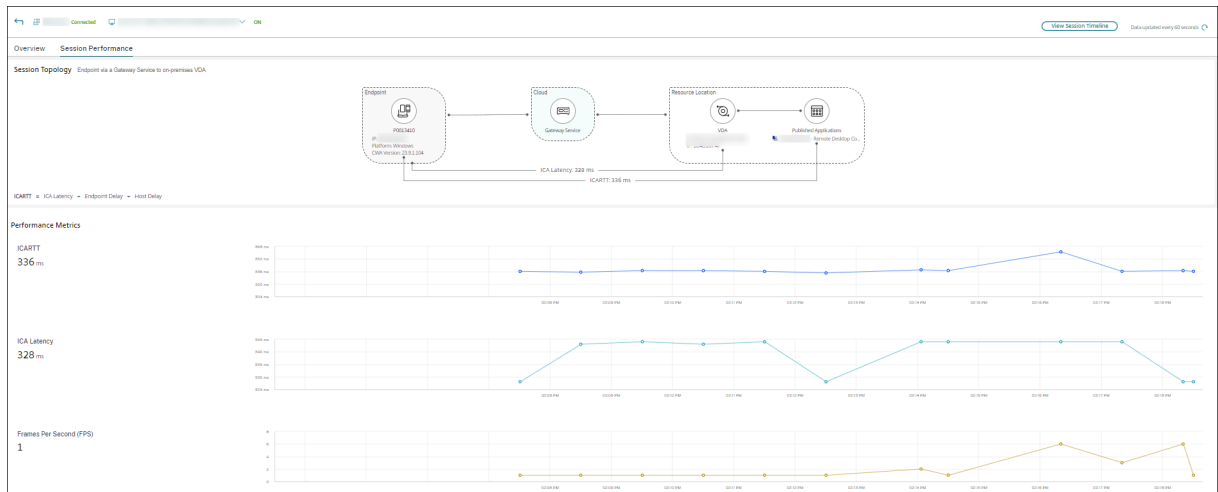

## End-to-end Network Hop view

End-to-end network hop view is the next step towards enhancing troubleshooting workflows. The **User Details > Session Performance > Session Topology** section provides a visual representation of the end-to-end network hop view for connected HDX sessions.

Session Topology for a connected session shows the components involved in the session path with their metadata, the link between the components, and the applications published on the VDA. In addition, the following session performance metrics are displayed for the session:

- ICA Latency - Latency is basically the network latency. This parameter indicates if the network is sluggish.
- ICA RTT - ICARTT is the time interval between a user's action and the graphical response displayed on their screen. This measurement includes ICA Latency, Endpoint Delay, and Host Delay.

You can use this view to understand the components through which the session data flows and identify the specific hop that might be bringing in performance issues.

The performance metrics on the Session Topology view are available only for HDX session in the connected state.

## Session Topology scenarios

Depending on the deployment scenario of the site, the components involved in a session are all or any of the following:

- Citrix Workspace app on Endpoint
- Gateway service/ on-premises Gateway

- Cloud Connector –Gateway is connected to DaaS via a Cloud Connector in the case of hybrid connections.
- VDAs

Accordingly, the possible network topologies are as follows:

- Citrix Workspace app on the endpoint connects via Citrix Workspace and Gateway Service to an on-premises VDA. No Cloud Connector is used to connect to VDA.

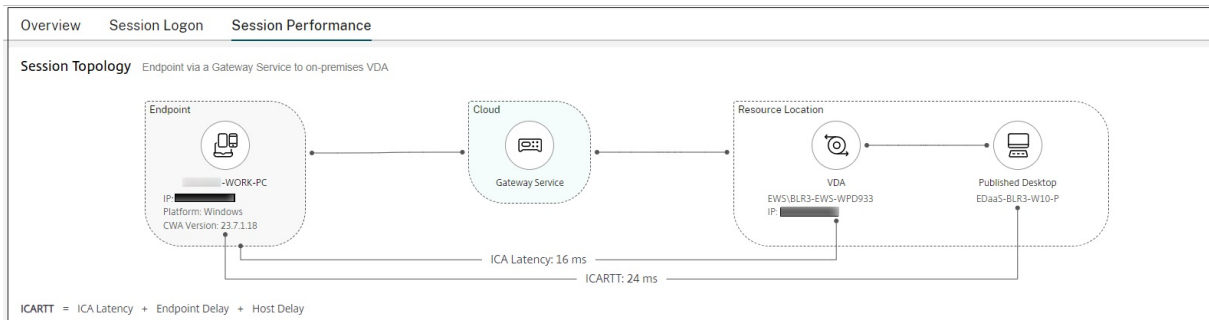

- Citrix Workspace app on the endpoint connects via Citrix Workspace and Gateway Service to an on-premises VDA via Cloud Connector.

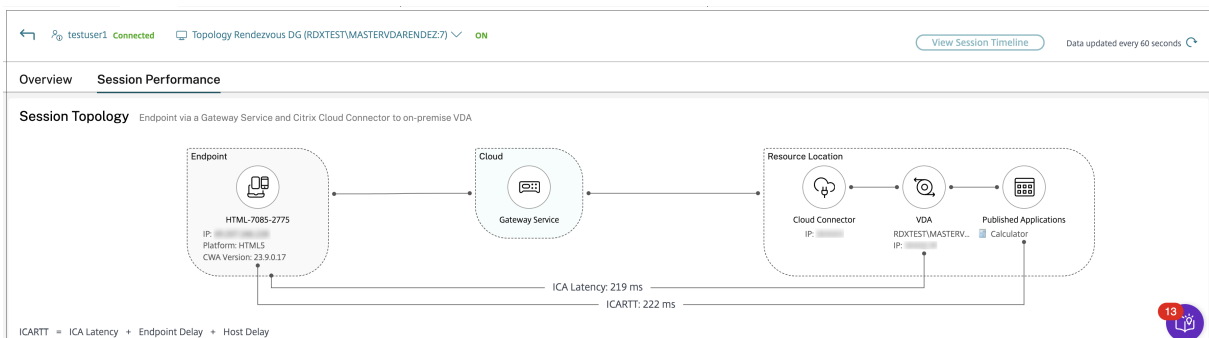

- Citrix Workspace app on the endpoint connects via StoreFront and on-premises Gateway to on-premises VDA.

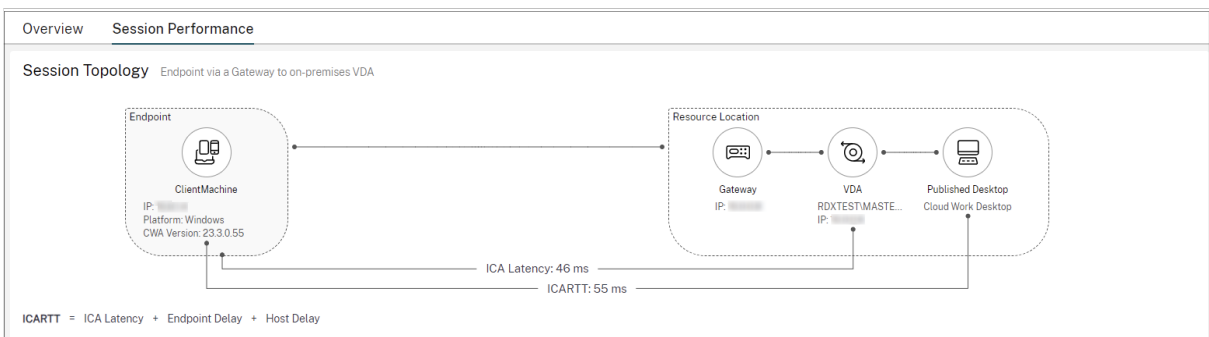

- Citrix Workspace app on the endpoint connects via StoreFront to on-premises VDA.

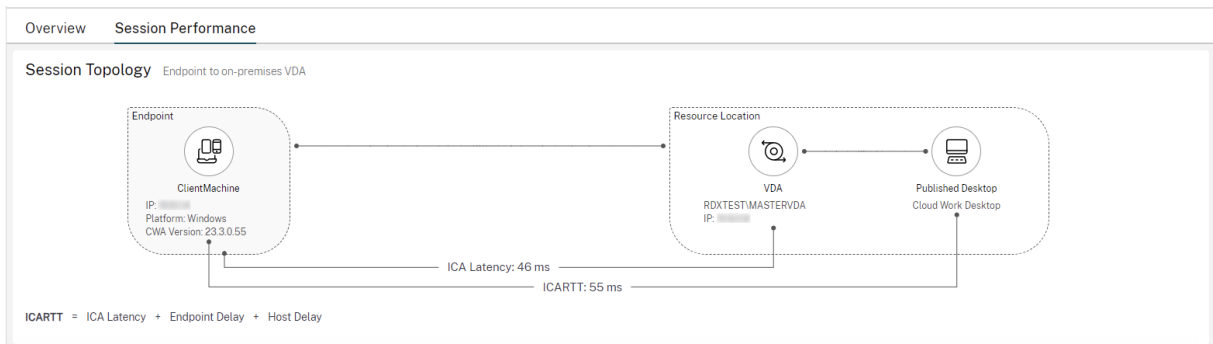

## Performance Metrics

The **Performance Metrics** panel offers the ability to correlate real-time metrics in identifying issues within user sessions. Trends for the session metrics help indicate how these metrics have performed over time. When you click the **Session Performance** tab, along with the real-time data, you can view the last 15 minutes data without waiting for the page load time. The plots help to correlate multiple component performance metrics in a single view.

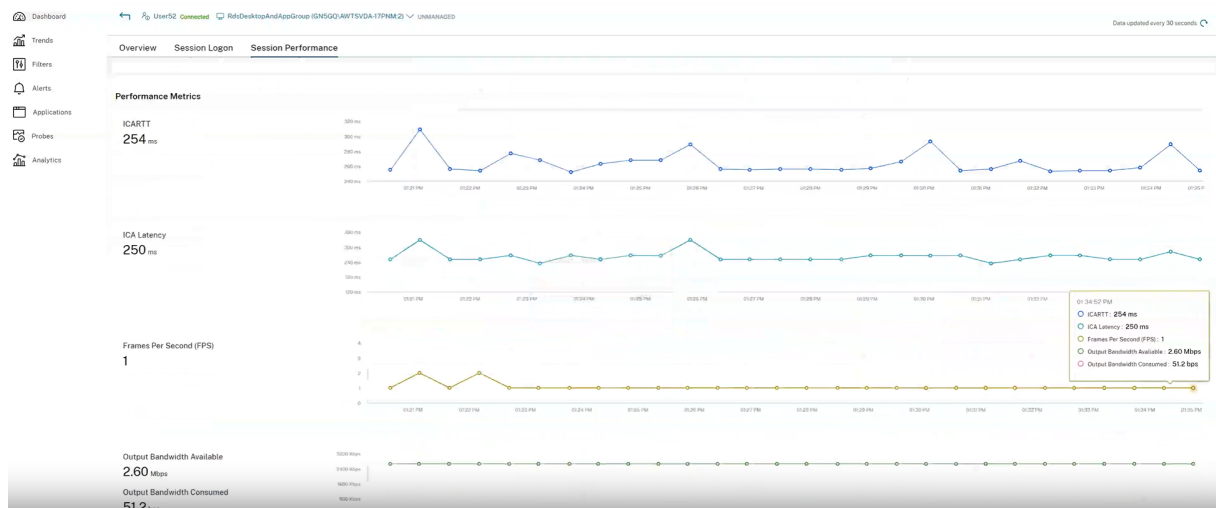

**Note:**

With the trailing 15 minutes metrics support, the graph is plotted for the duration for which the session is connected and disconnected. The disconnected session’s metric is displayed with the value zero.

Apart from ICARTT and ICA Latency, the following metrics are available:

- **Frames Per Second** - Frames Per Second is an important metric that indicates the session responsiveness.
- **Output Bandwidth Available** - Output Bandwidth Available is a measure of the total bandwidth available to transmit data from the VDA to the endpoint.

- Output Bandwidth Consumed - Output Bandwidth Consumed indicates the actual amount of data transmitted from the VDA to the endpoint to display sessions to users.

Analyzing Output Bandwidth Available and the Output Bandwidth Consumed helps check if sufficient bandwidth is available to serve sessions and to detect if a session is affected by insufficient bandwidth.

## Shadow users

December 16, 2020

From Director, use the shadow user feature to view or work directly on a user's virtual machine or session. You can shadow both Windows or and Linux VDAs. The user must be connected to the machine that you want to shadow. Verify this by checking the machine name listed in the user title bar.

Director launches shadowing in a new tab, update your browser settings to allow pop-ups from the Director URL.

Access the shadowing feature from the **User Details** view. Select the user session, and click **Shadow** in the Activity Manager view or the Session Details panel.

## Shadowing Linux VDAs

Shadowing is available for Linux VDAs Version 7.16 or and later running the RHEL7.3 or Ubuntu Version 16.04 Linux distributions.

### Note:

- The VDA must be accessible from the Director UI for shadowing to work. Hence, shadowing is possible only for Linux VDAs in the same intranet as the Director client.
- Director uses FQDN to connect to the target Linux VDA. Ensure that the Director client can resolve the FQDN of the Linux VDA.
- The VDA must have the python websockify and x11vnc packages installed.
- noVNC connection to the VDA uses the WebSocket protocol. By default, **ws://** WebSocket protocol is used. For security reasons, Citrix recommends that you use the secure **wss://** protocol. Install SSL certificates on each Director client and Linux VDA.

Follow the instructions in [Session Shadowing](#) to configure your VDA for shadowing.

1. After you click **Shadow**, the shadowing connection initializes and a confirmation prompt appears on the user device.



2. Instruct the user to click **Yes** to start the machine or session sharing.
3. The administrator can only view the shadowed session.

## Shadowing Windows VDAs

Windows VDA sessions are shadowed using Windows Remote Assistance. Enable the **User Windows Remote Assistance** feature while installing the VDA. For more information, see [Enable or Disable features](#).

1. After you click **Shadow**, the shadowing connection initializes and a dialog box prompts you to open or save the .msrc incident file.
2. Open the incident file with the Remote Assistance Viewer, if not already selected by default. A confirmation prompt appears on the user device.
3. Instruct the user to click **Yes** to start the machine or session sharing.
4. For more control, ask the user to share keyboard and mouse control.

## Streamline Microsoft Internet Explorer browsers for shadowing

Configure your Microsoft Internet Explorer browser to automatically open the downloaded Microsoft Remote Assistance (.msra) file with the Remote Assistance client.

To do this, you must enable the Automatic prompting for file downloads setting in the Group Policy editor:

Computer Configuration > Administrative Templates > Windows Components > Internet Explorer > Internet Control Panel > Security Page > Internet Zone > Automatic prompting for file downloads.

By default, this option is enabled for sites in the Local intranet zone. If the Director site is not in the Local intranet zone, consider manually adding the site to this zone.

## Send messages to users

June 21, 2020

From Director, send a message to a user who is connected to one or more machines. Use this feature to send immediate notices about administrative actions such as impending desktop maintenance, machine logoffs and restarts, and profile resets.

1. In the Activity Manager view, select the user and click Details.
2. In the User Details view, locate the Session Details panel and click Send Message.
3. Type your message information in the Subject and Message fields, and click Send.

If the message is sent successfully, a confirmation message appears in Director. The message appears in the user's machine.

If the message is not sent successfully, an error message appears in Director. Troubleshoot the problem according to the error message. When you have finished, type the subject and message text again and click **Try** again.

## Resolve application failures

August 9, 2021

In the **Activity Manager** view, click the Applications tab. You can view all the applications on all machines to which this user has access, including local and hosted applications for the currently connected machine, and the status of each.

**Note:**

If the Applications tab is grayed out, contact an administrator with the permission to enable the tab.

The list includes only those applications that were launched within the session.

For Multi-session OS machines and Single-session OS machines, applications are listed for each disconnected session. If the user is not connected, no applications are displayed.

---

| Action                                     | Description                                                                                                                                                                                                                                                                                                  |
|--------------------------------------------|--------------------------------------------------------------------------------------------------------------------------------------------------------------------------------------------------------------------------------------------------------------------------------------------------------------|
| End the application that is not responding | Choose the application that is not responding and click End Application. Once the application is terminated, ask the user to launch it again.                                                                                                                                                                |
| End processes that are not responding      | If you have the required permission, click the Processes tab. Select a process that is related to the application or using a high amount of CPU resources or memory, and click End Process. However, if you do not have the required permission to terminate the process, attempting to end a process fails. |

---

| Action                                | Description                                                                                                                                                                                                                                                                                                                                                                                          |
|---------------------------------------|------------------------------------------------------------------------------------------------------------------------------------------------------------------------------------------------------------------------------------------------------------------------------------------------------------------------------------------------------------------------------------------------------|
| Restart the user's machine            | For Single-session OS machines only, for the selected session, click Restart. Alternatively, from the Machine Details view, use the power controls to restart or shut down the machine. Instruct the user to log on again so that you can recheck the application. For Multi-session OS machines, the restart option is not available. Instead, log off from the user and let the user log on again. |
| Put the machine into maintenance mode | If the machine's image needs maintenance, such as a patch or other updates, put the machine into maintenance mode. From the Machine Details view, click Details and turn on the maintenance mode option. Escalate to the appropriate administrator.                                                                                                                                                  |

---

## Restore desktop connections

June 21, 2020

From Director, check the user's connection status for the current machine in the user title bar.

If the desktop connection failed, the error that caused failure is displayed and can help you decide how to troubleshoot.

---

| Action                                             | Description                                                                                                                                                                                                                                  |
|----------------------------------------------------|----------------------------------------------------------------------------------------------------------------------------------------------------------------------------------------------------------------------------------------------|
| Ensure that the machine is not in maintenance mode | On the User Details page, make sure maintenance mode is turned off.                                                                                                                                                                          |
| Restart the user's machine                         | Select the machine and click <b>Restart</b> . Use this option if the user's machine is unresponsive or unable to connect. For example, when the machine is using an unusually high amount of CPU resources, which can make the CPU unusable. |

---

## Restore sessions

June 21, 2020

If a session becomes disconnected, it is still active and its applications continue to run, but the user device is no longer communicating with the server.

In the User Details view, troubleshoot session failures in the **Session Details** panel. You can view the details of the current session, indicated by the session ID.

---

| Action                                                | Description                                                                                                                                                                                                                                                                                                                                        |
|-------------------------------------------------------|----------------------------------------------------------------------------------------------------------------------------------------------------------------------------------------------------------------------------------------------------------------------------------------------------------------------------------------------------|
| End applications or processes that are not responding | Click the <b>Applications</b> tab. Select any application that is not responding and click <b>End Application</b> . Similarly, select any corresponding process that is not responding and click <b>End Process</b> . Also, end processes that are consuming an unusually high amount of memory or CPU resources, which can make the CPU unusable. |
| Disconnect the Windows session                        | Click <b>Session Control</b> and then select <b>Disconnect</b> . This option is available only for brokered Multi-session OS machines. For non-brokered sessions, the option is disabled.                                                                                                                                                          |
| Log off from the user's session                       | Click <b>Session Control</b> and then select <b>Log Off</b> .                                                                                                                                                                                                                                                                                      |

---

To test the session, the user can attempt to log back on to it. You can also shadow the user to more closely monitor this session.

## Run HDX channel system reports

July 1, 2020

In the **User Details** view, check the status of the HDX channels on the user's machine in the **HDX** panel. This panel is available only if the user machine is connected using HDX.

If a message appears indicating that the information is not currently available, wait for one minute for the page to refresh, or select the **Refresh** button. HDX data takes a little longer to update than other data.

Click an error or warning icon for more information.

**Tip:**

You can view information about other channels in the same dialog box by clicking the left and right arrows in the left corner of the title bar.

HDX channel system reports are used mainly by Citrix Support to troubleshoot further.

1. In the HDX panel, click Download System Report.
2. You can view or save the .xml report file.
  - To view the .xml file, click Open. The .xml file appears in the same window as the Director application.
  - To save the .xml file, click Save. The Save As window appears, prompting you for a location on the Director machine to download the file to.

## Reset a user profile

November 12, 2021

**CAUTION:**

When a profile is reset, the user's folders and files are saved and copied to the new profile. However, most user profile data is missing (for example, the registry is reset and application settings might be deleted).

Starting with Profile Management 2106, the reset function is available for the Citrix Management profile container-based user profile solution.

### How reset profiles are processed

Any Citrix user profile or Microsoft roaming profile can be reset. After the user logs off and you select the reset command (either in Director or using the PowerShell SDK), Director first identifies the user profile in use and issues an appropriate reset command. Director receives the information through Profile Management, including information about the profile size, type, and logon timings.

This diagram illustrates the process following the user logon, when a user profile is reset.

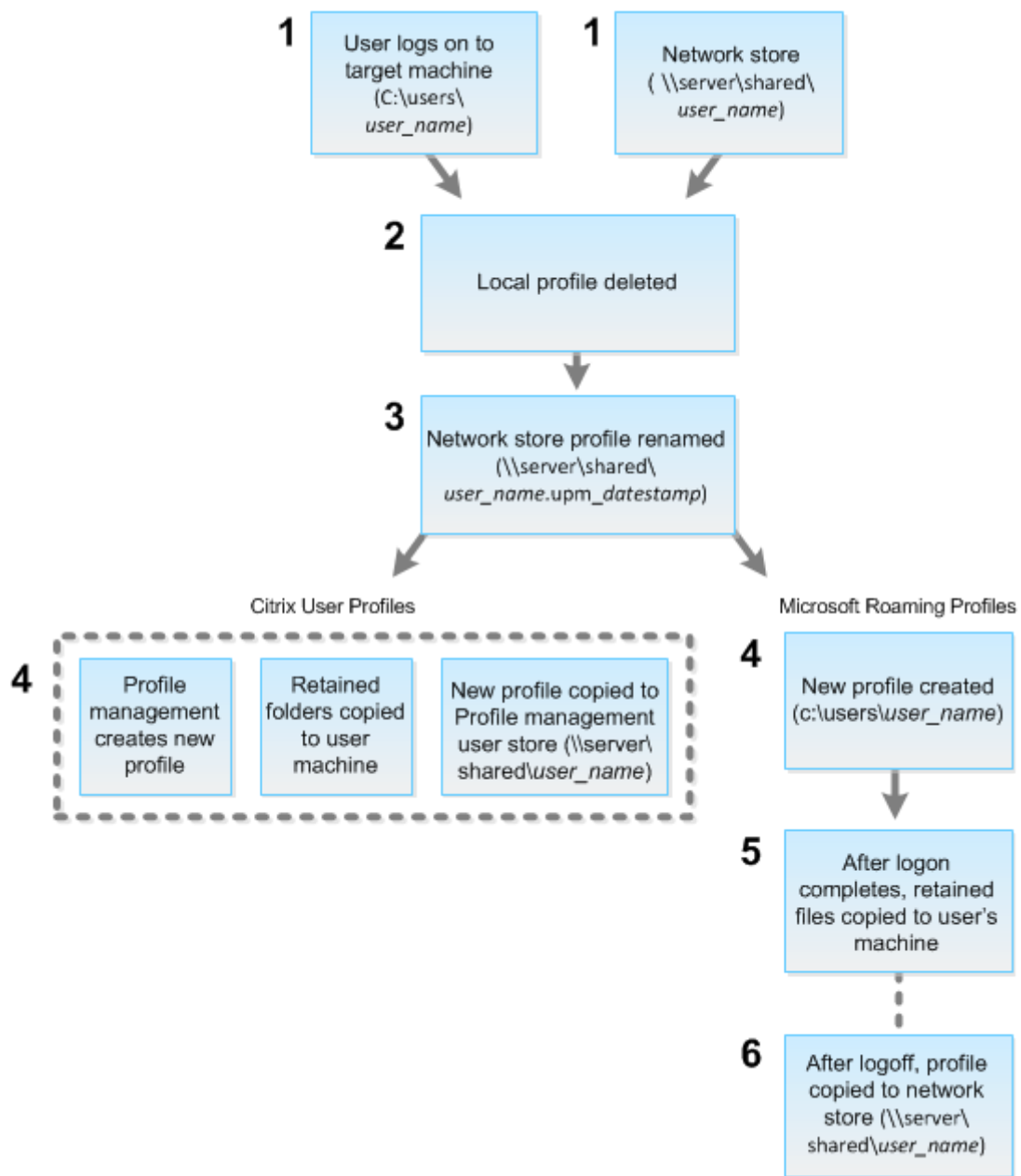

The reset command issued by Director specifies the profile type. The Profile Management service then attempts to reset a profile of that type and looks for the appropriate network share (user store). If the user is processed by Profile Management, but receives a roaming profile command, it is rejected (or the opposite way).

1. If a local profile is present, it is deleted.
2. The network profile is renamed.
3. The next action depends on whether the profile being reset is a Citrix user profile or a Microsoft roaming profile.

For Citrix user profiles, the new profile is created using the Profile Management import rules. The folders are copied back to the network profile, and the user can log on normally. If a roaming profile is used for the reset, any registry settings in the roaming profile are preserved in the reset profile. You can configure Profile Management so that a template profile overrides the roaming profile, if necessary.

For Microsoft roaming profiles, Windows creates a profile, and when the user logs on, the folders are copied back to the user device. When the user logs off again, the new profile is copied to the network store.

## To reset a user profile in Director

If you are using the Citrix Virtual Desktops (Desktop VDA), do the following:

1. From **Director**, search for the user whose profile you want to reset, and then select this user's session.
2. Click **Reset Profile**.
3. Instruct the user to log off from all sessions.
4. Instruct the user to log back on.

The folders and files that were saved from the user's profile are copied to the new profile.

If you are using Citrix Virtual Desktops (Server VDA), you need to be logged on to perform the profile reset. The user then needs to log off, and log back on to complete the profile reset.

### Important:

If the user has profiles on multiple platforms (such as Windows 8 and Windows 7), instruct the user to log back on first to the same desktop or app that the user reported as a problem. This logon action ensures that the correct profile is reset. If the profile is a Citrix user profile, the profile is already reset by the time the user's desktop appears. If the profile is a Microsoft roaming profile, the folder restoration might still be in progress for a brief time. The user must stay logged on until the restoration is complete.

If the profile is not successfully reset (for example, the user cannot successfully log back on to the machine or some of the files are missing), you must [manually restore the original profile](#).

Note the following:

- If the user store is enabled as the user profile solution, the new profile contains the following personal folders from the original user profile:
  - Desktop
  - Cookies
  - Favorites

- Documents
  - Pictures
  - Music
  - Videos
- If the Citrix Management profile container is enabled as the entire user profile solution, the new profile doesn't contain the preceding personal folders.
  - In Windows 8 and later, cookies are not copied to the new profile when profiles are reset.

### To manually restore a profile after a failed reset

1. Instruct the user to log off from all sessions.
2. Delete the local profile if one exists.
3. Locate the archived folder on the network share that contains the date and time appended to the folder name, the folder with a .upm\_datestamp extension.
4. Delete the current profile name. That is, the one without the upm\_datestamp extension.
5. Rename the archived folder using the original profile name. That is, remove the date and time extension. You have returned the profile to its original, pre-reset state.

### To reset a profile using PowerShell SDK

You can reset a profile using the Broker PowerShell SDK.

#### **New-BrokerMachineCommand**

Creates a command queued for delivery to a specific user, session, or machine. For more information about this cmdlet, see <https://citrix.github.io/delivery-controller-sdk/Broker/New-BrokerMachineCommand/>.

#### **Examples**

See the following examples for details about how to use the PowerShell cmdlets to reset a profile:

Reset a Profile Management profile

- Suppose you want to reset the profile for user1. Use the New-BrokerMachineCommand PowerShell command. For example:
  - `New-BrokerMachineCommand -Category UserProfileManager -CommandName "ResetUpmProfile" -DesktopGroups 1 -CommandData $byteArray -SendTrigger logon -user domain1\user1`



**Important:**

The `CommandData $byteArray` must be in the following format: `<SID>[, <backup path>]`. If you do not provide the backup path, Profile Management generates a backup folder named by current date and time.

### Reset a Windows roaming profile

- Suppose you want to reset the roaming profile for user1. Use the `New-BrokerMachineCommand` PowerShell command. For example:
  - `New-BrokerMachineCommand -Category UserProfileManager -CommandName "ResetRoamingProfile"-DesktopGroups 1 -CommandData $byteArray -SendTrigger logon -user domain1\user1`

## Record sessions

March 22, 2024

You can record ICA sessions using the Session Recording controls from the **User Details** and **Machine Details** screen in Director. This feature is available for customers on **Premium** sites.

### Dynamic Session Recording

You can record the current active session using the Session Recording controls from the **User Details** screen. For more information about Dynamic Session Recording, see the [Session Recording service](#) article.

### Policy based Session Recording

To configure Policy-based Session Recording on Director using the DirectorConfig tool, see the **Configure Director to use the Session Recording Server** section in [Configure session recording policies](#). The Session Recording controls are available in Director only if the logged-in user has the permission to modify the Session Recording policies. This permission can be set on the Session Recording Authorization console as described in [Authorize users](#).

**Note:**

Changes made to the Session Recording settings through Director or the Session Recording Policy console take effect starting from the subsequent ICA session.

## Session Recording controls in Director

You can use the **User Details > Session Recording** actions to record the current or subsequent sessions.

- Turn ON Dynamic Session Recording - the current session is recorded.
- Turn ON (with notification) - the subsequent sessions are recorded and the user is notified about the session being recorded on logging on to the ICA session.
- Turn ON (without notification) - the subsequent sessions are recorded and the session is recorded silently without notifying the user.
- Turn OFF - disable recording of sessions for the user.

The **Policies** Panel displays the name of the active Session Recording policy.

The screenshot displays the 'User Details' page for a user named 'User5'. The 'Session Recording' dropdown menu is open, showing the following options:

- Dynamic Session Recording (Record current session)
- Turn On
- Policy based Session Recording (Record subsequent sessions)
- Turn On (With Notification)
- Turn On (Without Notification)

The 'Machine Details' panel shows the following session recording settings:

- Session Recording: Off
- Registration State: Registered
- OS Type: Windows 2022
- Allocation Type: Random
- Machine IP: [Redacted]
- Organizational Unit: CN=TSVDA-PS-1,OU=Domain Computers,DC=azureddc,DC=local
- VDA Version: 2308.0.0.33

The 'Session Details' panel shows the following session information:

- Session State: [Redacted]
- Application State: [Redacted]
- Anonymous: [Redacted]
- Time in State: 2 hours 3 mins
- Endpoint IP: [Redacted]
- Endpoint Name: BANWRUPAKD-2
- Connection Type: HDX
- Protocol: UDP
- Client Workspace App Version: 23.5.1.83
- ICA RTT: 29 ms [View Trend](#)
- ICA Latency: 32 ms [View Trend](#)
- Launched Via: [Redacted]
- Connected Via: [Redacted]

The **Machine Details** panel displays the status of the Session Recording policy for the machine.

## Play back live and recorded sessions

You can play back recorded and live user sessions to understand the issues encountered by the user. Ready access to recordings and session related metrics within the Director console eliminates the requirement of searching for the recordings across multiple session recording servers or looking for third-party apps to view the recordings. It helps correlate the issues discovered in the recordings with the performance metrics.

This feature requires the following:

- VDA and the Session Recording servers are on version 2308 or later.
- Delivery Controller and Director are on version 2311 or later.

Director stores session recordings in a centralized repository. The list of recordings belonging to the user are displayed on clicking the **Session Selector** modal > **Sessions with recordings** link.

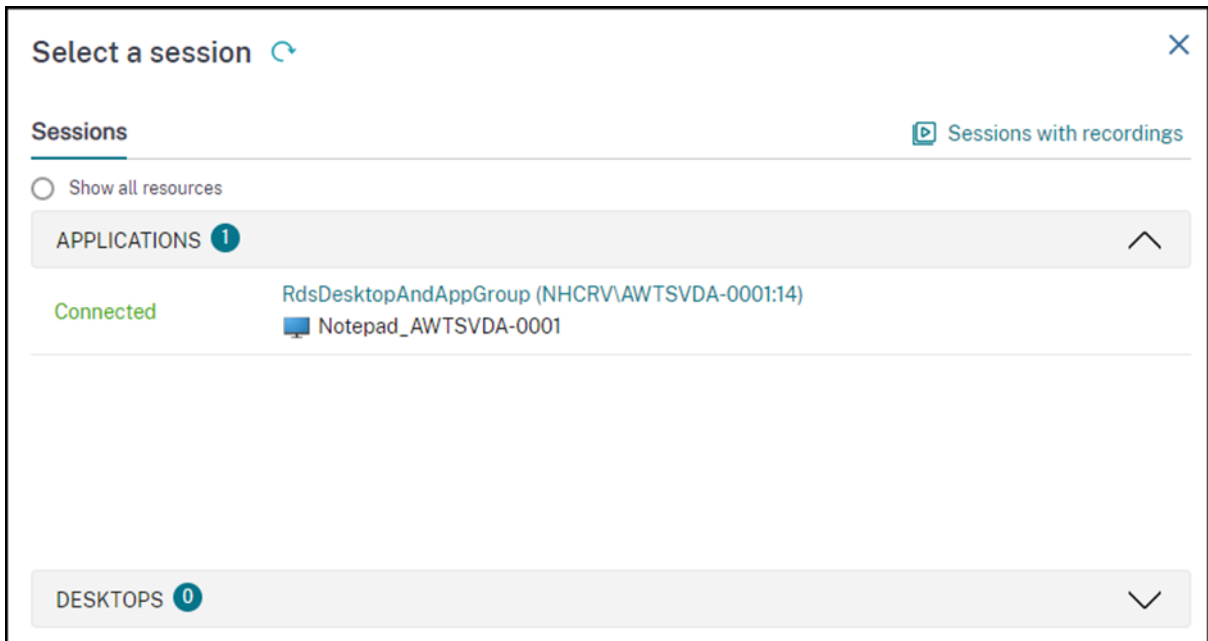

You can choose to view recordings of sessions that were active during the last 24 hours or the last 2 days. Live recordings of currently active sessions are marked with **Session End Time** as **Running**.

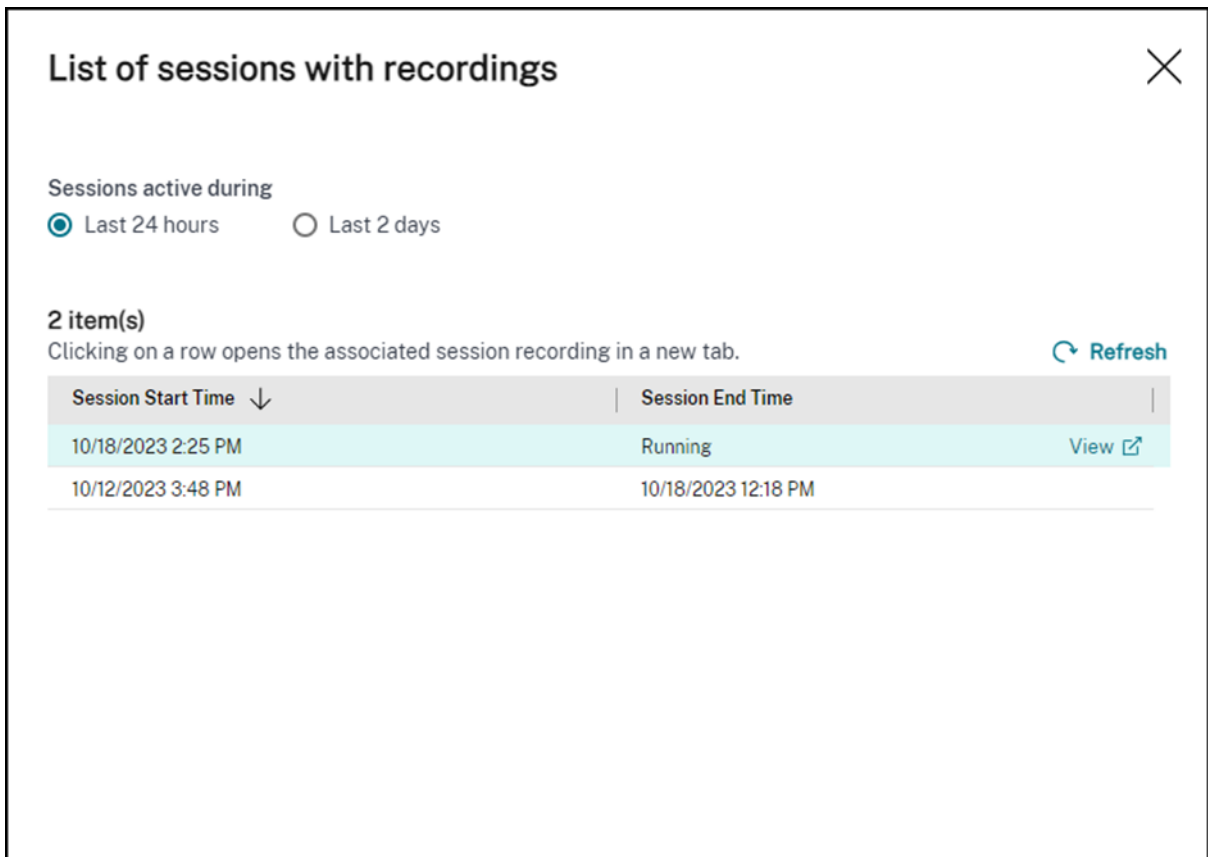

Click the **View** link to play back the recording on a new tab using the Citrix Session Recording playback server.

## Feature compatibility matrix

March 22, 2024

Citrix Director 7 2203 is compatible with:

- Citrix Virtual Apps and Desktops 7 2112 and later
- Citrix Virtual Apps and Desktops 7 1912 LTSR

Within each site, although you can use Director with earlier versions of Delivery Controller, all the features in the latest version of Director might not be available. Citrix recommends having Director, Delivery Controller, and the VDAs at the same version.

**Note:**

After you upgrade a Delivery Controller, you are prompted to upgrade the site when you open Studio. For more information, see the **Upgrade Sequence** section in [Upgrade a deployment](#).

The first time you log in after a Director upgrade, a version check is performed on the configured sites. If any site is running a version of the Controller earlier than that of Director, a message appears on the Director console, recommending a site upgrade. Additionally, as long as the version of the site is older than that of Director, a note remains displayed on the Director Dashboard indicating this mismatch.

**Note:**

Earlier versions of Citrix Director do not display policies applied to user sessions running on recent VDA versions. Citrix Director 1912 and earlier versions do not display policies applied to user sessions running on VDA versions 2003 and later. Use Citrix Director versions 2003 and later to view those policies.

Specific Director features with the minimum version of Delivery Controller (DC), VDA and other dependent components required along with License Edition are listed below.

| <b>Director Version</b> | <b>Feature</b>                                       | <b>Dependencies - min version required</b> | <b>Edition</b> |
|-------------------------|------------------------------------------------------|--------------------------------------------|----------------|
| 2311                    | <a href="#">Play Back live and recorded sessions</a> | VDA 2308 and DDC 2311                      | All            |
| 2311                    | <a href="#">Session Topology</a>                     | None                                       | All            |

| <b>Director Version</b> | <b>Feature</b>                                                            | <b>Dependencies - min version required</b>                         | <b>Edition</b> |
|-------------------------|---------------------------------------------------------------------------|--------------------------------------------------------------------|----------------|
| 2311                    | Optimal screen resolution                                                 | None                                                               | All            |
| 2311                    | MS Teams Optimization                                                     | VDA 2311 and DDC latest                                            | All            |
| 2311                    | Probes Overview enhancements                                              | None                                                               | All            |
| 2311                    | Revamped Session Logon Duration view                                      | None                                                               | All            |
| 2308                    | Probes summary and drilldown                                              | None                                                               | All            |
| 2308                    | Citrix Probe Agent support for Citrix Gateway Multi-factor authentication | Citrix Gateway                                                     | All            |
| 2308                    | Disable Hypervisor Alerts                                                 | None                                                               | All            |
| 2308                    | Trends for Session Experience metrics                                     | None                                                               | All            |
| 2305                    | Support authentication via Citrix Gateway                                 | None                                                               | All            |
| 2305                    | Autoscale management in Director                                          | None                                                               | All            |
| 2303                    | Failed Machines Alert                                                     | DC 7 2303                                                          | Premium        |
| 2203                    | TLS 1.3 support                                                           | -                                                                  | All            |
| 2212                    | Real-time GPU Utilization available for AMD GPUs                          | DC 7.14 and VDA 7.14 running 64-bit Windows and HDX 3D Pro enabled | All            |
| 2212                    | Advanced Probe Scheduling                                                 | DC 7 1906 and Citrix Probe Agent 2209                              | Premium        |

| <b>Director Version</b> | <b>Feature</b>                                                                | <b>Dependencies - min version required</b>        | <b>Edition</b>              |
|-------------------------|-------------------------------------------------------------------------------|---------------------------------------------------|-----------------------------|
| 1909                    | <a href="#">Configure on-prem sites with Citrix Analytics for Performance</a> | DC 7 1906 and VDA 1906                            | All                         |
| 1906                    | <a href="#">Session Auto Reconnect</a>                                        | DC 7 1906 and VDA 1906                            | All                         |
| 1906                    | <a href="#">Session startup duration</a>                                      | DC 7 1906 and VDA 1903                            | All                         |
| 1906                    | <a href="#">Desktop probing</a>                                               | DC 7 1906 and Citrix Probe Agent 1903             | Premium                     |
| 7.9 and later           | <a href="#">Citrix Profile Management Duration in Profile Load</a>            | VDA 1903                                          | All                         |
| 1811                    | <a href="#">Profile Drilldown</a>                                             | DC 7 1811 and VDA 1811                            | All                         |
| 1811                    | <a href="#">Hypervisor Alerts Monitoring</a>                                  | DC 7 1811                                         | Premium                     |
| 1811                    | <a href="#">Application probing</a>                                           | DC 7 1811 and Citrix Application Probe Agent 1811 | Premium                     |
| 1811                    | <a href="#">Microsoft RDS license health</a>                                  | DC 7 1811 and VDA 7.16                            | All                         |
| 1811                    | <a href="#">Key RTOP Data display</a>                                         | DC 7 1811 and VDA 1808                            | Premium                     |
| 1808                    | <a href="#">Export of Filters data</a>                                        | DC 7 1808                                         | All                         |
| 1808                    | <a href="#">Interactive Session drill down</a>                                | DC 7 1808 and VDA 1808                            | All                         |
| 1808                    | <a href="#">GPO drill down</a>                                                | DC 7 1808 and VDA 1808                            | All                         |
| 1808                    | <a href="#">Machine historical data available using OData API</a>             | DC 7 1808                                         | All                         |
| 7.18                    | <a href="#">Application probing</a>                                           | DC 7.18                                           | Premium (formerly Platinum) |

| <b>Director Version</b> | <b>Feature</b>                                                               | <b>Dependencies - min version required</b> | <b>Edition</b>              |
|-------------------------|------------------------------------------------------------------------------|--------------------------------------------|-----------------------------|
| 7.18                    | <a href="#">Smart alert policies</a>                                         | DC 7.18                                    | Premium (formerly Platinum) |
| 7.18                    | <a href="#">Health Assistant link</a>                                        | None                                       | All                         |
| 7.18                    | <a href="#">Interactive Session drill-down</a>                               | None                                       | All                         |
| 7.17                    | <a href="#">PIV smart card authentication</a>                                | None                                       | All                         |
| 7.16                    | <a href="#">Application Analytics</a>                                        | DC 7.16 and VDA 7.15                       | All                         |
| 7.16                    | <a href="#">OData API V.4</a>                                                | DC 7.16                                    | All                         |
| 7.16                    | <a href="#">Shadow Linux VDA users</a>                                       | VDA 7.16                                   | All                         |
| 7.16                    | <a href="#">Domain local group support</a>                                   | None                                       | All                         |
| 7.16                    | <a href="#">Machine console access</a>                                       | DC 7.16                                    | All                         |
| 7.15                    | <a href="#">Application failure monitoring</a>                               | DC 7.15 and VDA 7.15                       | All                         |
| 7.14                    | <a href="#">Application-centric troubleshooting</a>                          | DC 7.13 and VDA 7.13                       | All                         |
| 7.14                    | <a href="#">Disk Monitoring</a>                                              | DC 7.14 and VDA 7.14                       | All                         |
| 7.14                    | <a href="#">GPU Monitoring</a>                                               | DC 7.14 and VDA 7.14                       | All                         |
| 7.13                    | <a href="#">Transport protocol on Session Details panel</a>                  | DC 7.x and VDA 7.13                        | All                         |
| 7.12                    | <a href="#">User-friendly Connection and Machine failure descriptions</a>    | DC 7.12 and VDA 7.x                        | All                         |
| 7.12                    | <a href="#">Increased historical data availability in Enterprise edition</a> | DC 7.12 and VDA 7.x                        | Enterprise                  |
| 7.12                    | <a href="#">Custom Reporting</a>                                             | DC 7.12 and VDA 7.x                        | Premium (formerly Platinum) |

| <b>Director Version</b> | <b>Feature</b>                                           | <b>Dependencies - min version required</b>         | <b>Edition</b>              |
|-------------------------|----------------------------------------------------------|----------------------------------------------------|-----------------------------|
| 7.11                    | Resource utilization reporting                           | DC 7.11 and VDA 7.11                               | All                         |
| 7.11                    | Alerting extended for CPU, memory and ICA RTT conditions | DC 7.11 and VDA 7.11                               | Premium (formerly Platinum) |
| 7.11                    | Export report improvements                               | DC 7.11 and VDA 7.x                                | All                         |
| 7.11                    | Integration with Citrix ADM                              | DC 7.11, VDA 7.x, and MAS version 11.1 Build 49.16 | Premium (formerly Platinum) |
| 7.9                     | Logon Duration breakdown                                 | DC 7.9 and VDA 7.x                                 | All                         |
| 7.7                     | Proactive monitoring and alerting                        | DC 7.7 and VDA 7.x                                 | Premium (formerly Platinum) |
| 7.7                     | Windows Authentication Integration                       | DC 7.x and VDA 7.x                                 | All                         |
| 7.7                     | Single-session and Multi-session OS Usage                | DC 7.7 and VDA 7.x                                 | Premium (formerly Platinum) |
| 7.6.300                 | Support for Framehawk virtual channel                    | DC 7.6 and VDA 7.6                                 | All                         |
| 7.6.200                 | Session recording integration                            | DC 7.6 and VDA 7.x                                 | Premium (formerly Platinum) |
| 7                       | HDX Insight integration                                  | DC 7.6, VDA 7.x, and Citrix ADM                    | Premium (formerly Platinum) |

## Data granularity and retention

April 1, 2024



## Aggregation of data values

The Monitor Service collects various data, including user session usage, user logon performance details, session load balancing details, and connection and machine failure information. Data is aggregated differently depending on its category. Understanding the aggregation of data values presented using the OData Method APIs is critical to interpreting the data. For example:

- Connected Sessions and Machine Failures occur over a period. Therefore, they are exposed as maximums over a time period.
- LogOn Duration is a measure of the length of time, therefore is exposed as an average over a time period.
- LogOn Count and Connection Failures are counts of occurrences over a period, therefore are exposed as sums over a time period.

## Concurrent data evaluation

Sessions must be overlapping to be considered concurrent. However, when the time interval is 1 minute, all sessions in that minute (whether they overlap) are considered concurrent. The size of the interval is so small that the performance overhead involved in calculating the precision is not worth the value added. If the sessions occur in the same hour, but not in the same minute, they are not considered to overlap.

## Correlation of summary tables with raw data

The data model represents metrics in two different ways:

- The summary tables represent aggregate views of the metrics in per minute, hour, and day time granularities.
- The raw data represents individual events or current state tracked in the session, connection, application, and other objects.

When attempting to correlate data across API calls or within the data model itself, it is important to understand the following concepts and limitations:

- **No summary data for partial intervals.** Metrics summaries are designed to meet the needs of historical trends over long periods of time. These metrics are aggregated into the summary table for complete intervals. There are no summary data for a partial interval at the beginning (oldest available data) of the data collection nor at the end. When viewing aggregations of a day (Interval=1440), this means that the first and most recent incomplete days do not have any data. Although raw data might exist for those partial intervals, it is never summarized. You can determine the earliest and latest aggregate interval for a particular data granularity by pulling

the min and max SummaryDate from a particular summary table. The SummaryDate column represents the start of the interval. The Granularity column represents the length of the interval for the aggregate data.

- **Correlating by time.** Metrics are aggregated into the summary table for complete intervals as described in the preceding section. They can be used for historical trends, but raw events might be more current in the state than what has been summarized for trend analysis. Any time-based comparison of summary to raw data must consider that there are no summary data for partial intervals that might occur or for the beginning and ending of the time period.
- **Missed and latent events.** Metrics that are aggregated into the summary table might be slightly inaccurate if events are missed or latent to the aggregation period. Although the Monitor Service attempts to maintain an accurate current state, it does not go back in time to recompute aggregation in the summary tables for missed or latent events.
- **Connection High Availability.** During connection high availability, there will be gaps in the summary data counts of current connections, but the session instances will still be running in the raw data.
- **Data retention periods.** Data in the summary tables is retained on a different grooming schedule from the schedule for raw event data. Data might be missing because it has been groomed away from summary or raw tables. Retention periods might also differ for different granularities of summary data. Lower granularity data (minutes) is groomed more quickly than higher granularity data (days). If data is missing from one granularity due to grooming, it might be found in a higher granularity. Since the API calls only return the specific granularity requested, receiving no data for one granularity does not mean that the data doesn't exist for a higher granularity for the same time period.
- **Time zones.** Metrics are stored with UTC time stamps. Summary tables are aggregated on hourly time zone boundaries. For time zones that don't fall on hourly boundaries, there might be some discrepancy as to where data is aggregated.

## Granularity and retention

The granularity of aggregated data retrieved by Director is a function of the time (T) span requested. The rules are as follows:

- $0 < T \leq 1$  hour - uses per-minute granularity
- $0 < T \leq 30$  days - uses per-hour granularity
- $T > 31$  days - uses per-day granularity

Requested data that does not come from aggregated data comes from the raw Session and Connection information. This data tends to grow fast, and therefore has its own grooming setting. Grooming ensures that only relevant data is kept long term. Grooming ensures better performance while maintaining the granularity required for reporting. Customers on Premium licensed sites can change the

grooming retention to their desired number of retention days, otherwise the default is used. In case there was a connectivity loss with the Site database, Monitor Service will use the default retention days for Premium entitlement as specified in the table below.

To access the settings, run the following PowerShell commands on the Delivery Controller:

```

1 asnp Citrix.*
2 Get-MonitorConfiguration
3 Set-MonitorConfiguration -<setting name> <value>
4 <!--NeedCopy-->

```

|   | Setting name                | Affected grooming                                   | Retention days for Premium | Retention days for Advanced |
|---|-----------------------------|-----------------------------------------------------|----------------------------|-----------------------------|
| 1 | GroomSessionsRetentionDays  | Session records retention after Session termination | 90                         | 31                          |
| 2 | GroomFailuresRetentionDays  | Monitor Failure and Connection-FailureLog records   | 90                         | 31                          |
| 3 | GroomLoadIndexRetentionDays | Load Index records                                  | 90                         | 31                          |

|   | Setting name                  | Affected grooming                                                                                                                                                                                           | Retention days for Premium | Retention days for Advanced |
|---|-------------------------------|-------------------------------------------------------------------------------------------------------------------------------------------------------------------------------------------------------------|----------------------------|-----------------------------|
| 4 | GroomDeletedRecords           | Machine, Days Catalog, DesktopGroup, and Hypervisor entities that have a LifecycleState of 'Deleted'. This setting also deletes any related Session, SessionDetail, Summary, Failure, or LoadIndex records. | 90                         | 31                          |
| 5 | GroomSummaryRecords           | DesktopGroupSummary, FailureLogSummary, and LoadIndexSummary records. Aggregated data - daily granularity.                                                                                                  | 365                        | 31                          |
| 6 | GroomMachineHoursLogRetention | HoursLogRetention applied to the VDA and Controller machines                                                                                                                                                | 90                         | 31                          |
| 7 | GroomMinuteRetention          | Aggregated data - minute granularity                                                                                                                                                                        | 3                          | 3                           |

|    | Setting name                                 | Affected grooming                                      | Retention days for Premium | Retention days for Advanced |
|----|----------------------------------------------|--------------------------------------------------------|----------------------------|-----------------------------|
| 8  | GroomHourlyRetentionDays                     | Application data - hourly granularity                  | 32                         | 31                          |
| 9  | GroomApplicationInstanceHistoryRetentionDays | Application Instance history                           | 90                         | Not applicable              |
| 10 | GroomNotificationLogRecordsRetentionDays     | Notification Log records                               | 90                         | Not applicable              |
| 11 | GroomResourceUsageRawDataRetentionDays       | Resource utilization data - raw data                   | 3                          | 3                           |
| 12 | GroomResourceUsageMinuteDataRetentionDays    | Resource utilization summary data - minute granularity | 7                          | 7                           |
| 13 | GroomResourceUsageHourDataRetentionDays      | Resource utilization summary data - hour granularity   | 30                         | 30                          |
| 14 | GroomResourceUsageDayDataRetentionDays       | Resource utilization summary data - day granularity    | 31                         | 31                          |
| 15 | GroomProcessUsageRawDataRetentionDays        | Process utilization data - raw data                    | 1                          | 1                           |
| 16 | GroomProcessUsageMinuteDataRetentionDays     | Process utilization data - minute granularity          | 3                          | 3                           |

|    | Setting name                                | Affected grooming                           | Retention days for Premium | Retention days for Advanced |
|----|---------------------------------------------|---------------------------------------------|----------------------------|-----------------------------|
| 17 | GroomProcessUsageRawDataRetentionDays       | Process utilization data - hour granularity | 7                          | 7                           |
| 18 | GroomProcessUsageMinuteDataRetentionDays    | Process utilization data - day granularity  | 30                         | 30                          |
| 19 | GroomSessionMetricsDataRetentionDays        | Session metrics data                        | 1                          | 1                           |
| 20 | GroomMachineMetricsDataRetentionDays        | Machine metrics data                        | 3                          | 3                           |
| 21 | GroomMachineMetricsSummaryDataRetentionDays | Machine metrics summary data                | 30                         | 30                          |
| 22 | GroomApplicationErrorRetentionDays          | Application error data                      | 1                          | 1                           |
| 23 | GroomApplicationFailureRetentionDays        | Application failure data                    | 1                          | 1                           |

**Caution:**

Modifying values on the Monitor Service database requires restarting the service for the new values to take effect. You are advised to make changes to the Monitor Service database only under the direction of Citrix Support.

The settings GroomProcessUsageRawDataRetentionDays, GroomResourceUsageRawDataRetentionDays, and GroomSessionMetricsDataRetentionDays are limited to their default values of 1, while GroomProcessUsageMinuteDataRetentionDays is limited to its default value of 3. The PowerShell commands to set these values have been disabled, as the process usage data tends to grow quickly. Also, license based retention settings are as follows:

- **Premium licensed sites** - the grooming retention for all settings is limited to 1000 days (Citrix recommends 365 days).
- **Advanced licensed sites** - the grooming retention for all settings is limited to 31 days.
- **All other sites** - the grooming retention for all settings is limited to 7 days.

**Exceptions:**

- GroomApplicationInstanceRetentionDays can be set only in Premium licensed sites.
- GroomApplicationErrorsRetentionDays and GroomApplicationFaultsRetentionDays are limited to 31 days in Premium licensed sites.

Retaining data for long periods have the following implications on table sizes:

- **Hourly data.** If hourly data is allowed to stay in the database for up to two years, a site of 1000 delivery groups can cause the database to grow as follows:  
1000 delivery groups x 24 hours/day x 365 days/year x 2 years = 17,520,000 rows of data. The performance impact of such a large amount of data in the aggregation tables is significant. Given that the dashboard data is drawn from this table, the requirements on the database server might be large. Excessively large amounts of data might have a dramatic impact on performance.
- **Session and event data.** Data collected every time a session is started and a connection/re-connection is made. For a large site (100 K users), this data grows fast. For example, two years' worth of these tables would gather more than a TB of data, requiring a high-end enterprise-level database.

## Citrix Director failure reasons and troubleshooting

July 14, 2023

The following tables describe the various failure categories, the reasons, and the action you need to take to resolve the issues. For more information, see [Enums, error codes, and descriptions](#).

### Connection failure errors

| Category | Reason                                      | Issue                                                                                                                                              | Action                                                         |
|----------|---------------------------------------------|----------------------------------------------------------------------------------------------------------------------------------------------------|----------------------------------------------------------------|
| N/A      | [0] Unknown. This error code is not mapped. | The Monitoring service cannot determine the reason for the reported launch or connection failure from information shared by the Brokering service. | Collect CDF logs on the controller and contact Citrix support. |
| [0] None | [1] None                                    | None                                                                                                                                               | N/A                                                            |

---

| Category           | Reason                  | Issue                                                                                                                                                                                                                                                                                                    | Action                                                                                                                                                                                                                                                                                       |
|--------------------|-------------------------|----------------------------------------------------------------------------------------------------------------------------------------------------------------------------------------------------------------------------------------------------------------------------------------------------------|----------------------------------------------------------------------------------------------------------------------------------------------------------------------------------------------------------------------------------------------------------------------------------------------|
| [2] MachineFailure | [2] SessionPreparation  | Session preparation request from the delivery controller to the VDA failed.<br>Possible causes:<br>Communication issues between the controller and the VDA, issues experienced by the Broker Service while creating a prepare request, or network issues resulting in the VDA not accepting the request. | Refer to troubleshooting steps listed in Knowledge center article, <a href="#">Troubleshooting Virtual Delivery Agent Registration with delivery controllers in Citrix Virtual Apps and Desktops</a> for common problems that cause communication issues between the controller and the VDA. |
| [2] MachineFailure | [3] RegistrationTimeout | The VDA was powered on, but a time-out occurred while it was attempting to register with the delivery controller.                                                                                                                                                                                        | Verify that the Citrix Broker Service is running on the delivery controller and that the Desktop service is running on the VDA. Start each if stopped.                                                                                                                                       |



| Category                     | Reason                | Issue                                                                                                                                                                                                                                                                                                           | Action                                                                                                                                                                                                                                                                                     |
|------------------------------|-----------------------|-----------------------------------------------------------------------------------------------------------------------------------------------------------------------------------------------------------------------------------------------------------------------------------------------------------------|--------------------------------------------------------------------------------------------------------------------------------------------------------------------------------------------------------------------------------------------------------------------------------------------|
| [1] ClientConnection-Failure | [4] ConnectionTimeout | The client did not connect to the VDA after the VDA was prepared for session launch. The session was successfully brokered, but a time-out occurred while waiting for the client to connect to the VDA. Possible causes: Firewall settings, network interruptions, or settings that prevent remote connections. | Check the Director console to see if the client currently has an active connection, which means no user is impacted. If no session exists, review the event logs on the client and on the VDA for any errors. Resolve any issues with network connectivity between the client and the VDA. |
| [4] NoLicensesAvailable      | [5] Licensing         | The licensing request failed. Possible causes: Insufficient number of licenses, or the license server has been down for more than 30 days.                                                                                                                                                                      | Verify that the license server is online and reachable. Resolve any network connectivity issues to the license server or reboot the license server if it appears to be malfunctioning. Verify that there are sufficient licenses in the environment and allocate more if necessary.        |

| Category                     | Reason        | Issue                                                                                                                                                                                                                                                                                                                                                                                                                                         | Action                                                                                                                                                                                                                                                                                                                                                                                                                                                                           |
|------------------------------|---------------|-----------------------------------------------------------------------------------------------------------------------------------------------------------------------------------------------------------------------------------------------------------------------------------------------------------------------------------------------------------------------------------------------------------------------------------------------|----------------------------------------------------------------------------------------------------------------------------------------------------------------------------------------------------------------------------------------------------------------------------------------------------------------------------------------------------------------------------------------------------------------------------------------------------------------------------------|
| [1] ClientConnection-Failure | [6] Ticketing | <p>A failure occurred during ticketing, indicating that the client connection to the VDA does not match the brokered request. A launch request ticket is prepared by the Broker and delivered in the ICA file. When the user attempts to launch a session, the VDA validates the launch ticket in the ICA file with the Broker.</p> <p>Possible causes: ICA file is corrupt or the user is attempting to make an unauthorized connection.</p> | <p>Verify that the user has access to the application or desktop based on user groups defined in the delivery groups. Instruct the user to relaunch the application or desktop to determine whether this is a one off issue. If the issue occurs again, review the client device event logs for errors. Verify that the VDA to which the user is attempting to connect is registered. If unregistered, review the event logs on the VDA and resolve any registration issues.</p> |
| [1] ClientConnection-Failure | [7] Other     | <p>A session has been reported as terminated from the VDA after the client has initially contacted the VDA but before it completed the connection sequence.</p>                                                                                                                                                                                                                                                                               | <p>Verify if the session was not terminated by the user before launch. Try relaunching the session, if the problem persists, collect CDF logs and contact Citrix support.</p>                                                                                                                                                                                                                                                                                                    |

| Category                     | Reason                     | Issue                                                                                                                                                                                            | Action                                                                                                                                                                                   |
|------------------------------|----------------------------|--------------------------------------------------------------------------------------------------------------------------------------------------------------------------------------------------|------------------------------------------------------------------------------------------------------------------------------------------------------------------------------------------|
| [1] ClientConnection-Failure | [8] GeneralFail            | The session failed to launch. Possible causes: A brokered launch was requested while the broker was still starting up or initializing, or internal error during the brokering phase of a launch. | Verify that the Citrix Broker Service is running and retry launching the session.                                                                                                        |
| [5] Configuration            | [9] MaintenanceMode        | The VDA, or the delivery group to which the VDA belongs, is set in maintenance mode.                                                                                                             | Determine whether maintenance mode is required. Disable maintenance mode on the delivery group or machine in question if it is not needed and instruct the user to attempt to reconnect. |
| [5] Configuration            | [10] ApplicationDisabled   | The application cannot be accessed by end users because it has been disabled by the administrator.                                                                                               | If the application is intended to be available for production use, enable the application and instruct the user to reconnect.                                                            |
| [4] NoLicensesAvailable      | [11] LicenseFeatureRefused | The feature being used is not covered by the existing licenses.                                                                                                                                  | Contact a Citrix sales representative to confirm the features that are covered by the existing Citrix Virtual Apps and Desktops license edition and type.                                |

| Category                   | Reason                      | Issue                                                                                                                                                                                                                                           | Action                                                                                                                                                                                                                                                                                                                                                   |
|----------------------------|-----------------------------|-------------------------------------------------------------------------------------------------------------------------------------------------------------------------------------------------------------------------------------------------|----------------------------------------------------------------------------------------------------------------------------------------------------------------------------------------------------------------------------------------------------------------------------------------------------------------------------------------------------------|
| [3]<br>NoCapacityAvailable | [13]<br>SessionLimitReached | All VDAs are in use and there is no capacity to host more sessions. Possible causes: All VDAs are in use (for single-session OS VDAs), or all VDAs have reached the configured maximum concurrent sessions allowed (for multi-session OS VDAs). | Verify if there are any VDAs in maintenance mode. Disable maintenance mode if it is not needed to free up more capacity. Consider increasing the value of <b>Maximum Number of Sessions</b> in the Citrix policy setting to allow more sessions per server VDA. Consider adding more multi-session OS VDAs. Consider adding more single-session OS VDAs. |
| [5] Configuration          | [14]<br>DisallowedProtocol  | The ICA and RDP protocols are not allowed.                                                                                                                                                                                                      | Run the <b>Get-BrokerAccessPolicyRule</b> PowerShell command on the delivery controller and verify that the <b>AllowedProtocols</b> value has all the desired protocols listed. This issue occurs only if there is a misconfiguration.                                                                                                                   |

| Category           | Reason                              | Issue                                                                                                                                                                                                                                                                                                                                                                                | Action                                                                                                                                                                                                                                                                                                                                     |
|--------------------|-------------------------------------|--------------------------------------------------------------------------------------------------------------------------------------------------------------------------------------------------------------------------------------------------------------------------------------------------------------------------------------------------------------------------------------|--------------------------------------------------------------------------------------------------------------------------------------------------------------------------------------------------------------------------------------------------------------------------------------------------------------------------------------------|
| [5] Configuration  | [15] ResourceUnavailable            | The application or desktop to which the user is attempting to connect is not available. This application or desktop might not exist, or there are no VDAs available to run it. Possible causes: The application or desktop has been unpublished, or the VDAs hosting the application or desktop have reached maximum load, or the application or desktop is set in maintenance mode. | Verify that the application or desktop is still published and the VDAs are not in maintenance mode. Determine whether the multi-session OS VDAs are at full load. If so, provision more multi-session OS VDAs. Verify that there are single-session OS VDAs available for connections. Provision more single-session OS VDAs if necessary. |
| [5] Configuration  | [16] ActiveSessionReconnectDisabled | The ICA session is active and connected to a different endpoint. However, because the <b>Active Session Reconnection</b> is disabled, the client cannot connect to the active session.                                                                                                                                                                                               | On the delivery controller, verify that <b>Active Session Reconnection</b> is enabled. Verify that the value of <b>DisableActiveSessionReconnect</b> in the registry, under <b>HKEY_LOCAL_MACHINE\Software</b> is set to 0.                                                                                                                |
| [2] MachineFailure | [17] NoSessionToReconnect           | The client attempted to reconnect to a specific session but the session was terminated.                                                                                                                                                                                                                                                                                              | Retry the workspace control reconnection.                                                                                                                                                                                                                                                                                                  |

| Category           | Reason            | Issue                                                                                                                                       | Action                                                                                                                                                                                                                                                                                                                                                           |
|--------------------|-------------------|---------------------------------------------------------------------------------------------------------------------------------------------|------------------------------------------------------------------------------------------------------------------------------------------------------------------------------------------------------------------------------------------------------------------------------------------------------------------------------------------------------------------|
| [2] MachineFailure | [18] SpinUpFailed | The VDA cannot be powered on for session launch. This is a hypervisor reported issue.                                                       | If the machine is still powered off, attempt to start the machine from Citrix Studio. If this fails, review the hypervisor connectivity and permissions. If the VDA is a PVS-provisioned machine, verify in the PVS console that the machine is running. If not, verify that the machine is assigned a Personal vDisk, log in to the hypervisor to reset the VM. |
| [2] MachineFailure | [19] Refused      | The delivery controller sends a request to the VDA to prepare for a connection from an end user, but the VDA actively refuses this request. | Verify via ping, that the delivery controller and the VDA can successfully communicate. If not, resolve any firewall or network routing issues.                                                                                                                                                                                                                  |

---

| Category                | Reason                         | Issue                                                                                                                                                                                                                                                                                                                                                                                    | Action                                                                                                                                             |
|-------------------------|--------------------------------|------------------------------------------------------------------------------------------------------------------------------------------------------------------------------------------------------------------------------------------------------------------------------------------------------------------------------------------------------------------------------------------|----------------------------------------------------------------------------------------------------------------------------------------------------|
| [2] MachineFailure      | [20] ConfigurationSet Failure  | The delivery controller did not send required configuration data, such as policy settings and session information, to the VDA during session launch. Possible causes:<br>Communication issues between the controller and the VDA, issues experienced by the Broker Service while creating a configuration set request, or network issues resulting in the VDA not accepting the request. | -                                                                                                                                                  |
| [3] NoCapacityAvailable | [21] MaxTotalInstancesExceeded | The maximum number of instances of an application has been reached. No additional instances of the application can be opened on the VDA. This issue is related to the application limits feature.                                                                                                                                                                                        | Consider increasing the application setting, <b>Limit the number of instances running at the same time</b> to a higher value if licensing permits. |

---

| Category                     | Reason                           | Issue                                                                                                                                                                                                                           | Action                                                                                                                                                                                                                                                                 |
|------------------------------|----------------------------------|---------------------------------------------------------------------------------------------------------------------------------------------------------------------------------------------------------------------------------|------------------------------------------------------------------------------------------------------------------------------------------------------------------------------------------------------------------------------------------------------------------------|
| [3] NoCapacityAvailable      | [22] MaxPerUserInstancesExceeded | The user is attempting to open more than one instance of an application but the application is configured to allow only a single instance of the application per user. This issue is related to the application limits feature. | Only one instance of the application is allowed per user by default. If multiple instances per user are required, consider clearing the <b>Limit to one instance per user</b> setting in the application setting.                                                      |
| [1] ClientConnection-Failure | [23] Communication error         | The delivery controller attempted to send information to the VDA, such as a request to prepare for a connection, but an error occurred during the communication attempt. This can be caused due to network disruptions.         | If already started, restart the Desktop service on the VDA to restart the registration process and verify that the VDA registers successfully. Confirm that the delivery controllers configured for the VDA are accurate via the details in the application event log. |



| Category                   | Reason                                                                                                             | Issue                                                                                                                                                                                                                                                                                                                                                       | Action                                                                                                                                                                                                                                                                                                                                                                                                             |
|----------------------------|--------------------------------------------------------------------------------------------------------------------|-------------------------------------------------------------------------------------------------------------------------------------------------------------------------------------------------------------------------------------------------------------------------------------------------------------------------------------------------------------|--------------------------------------------------------------------------------------------------------------------------------------------------------------------------------------------------------------------------------------------------------------------------------------------------------------------------------------------------------------------------------------------------------------------|
| [3]<br>NoCapacityAvailable | [100]<br>NoMachineAvailable<br>Monitoring service<br>converts [12]<br>NoDesktopAvailable to<br>this error code.    | The VDA assigned to launch the session is in an invalid state or is unavailable. Possible causes: Power state of the VDA is unknown or unavailable, the VDA did not reboot since the last user's session, session sharing is disabled while the current session requires it to be enabled, or the VDA was removed from the delivery group or from the site. | Verify that the VDA is in a delivery group. If not, add it to the appropriate delivery group. Verify that there are sufficient VDAs registered and in ready state to be able to launch the published shared desktop or application requested by the user. Verify that the hypervisor hosting the VDA is not in maintenance mode.                                                                                   |
| [2] MachineFailure         | [101]<br>MachineNotFunctional.<br>Monitoring service<br>converts [12]<br>NoDesktopAvailable to<br>this error code. | The VDA is not operational. Possible causes: The VDA was removed from the delivery group, the VDA is unregistered, the VDA power state is unavailable, or the VDA is experiencing internal issues.                                                                                                                                                          | Verify that the VDA is in a delivery group. If not, add it to the appropriate delivery group. Verify that the VDA shows as powered on in Citrix Studio. If the power state is unknown for several machines, resolve any issues with connectivity to the hypervisor or host failures. Verify that the hypervisor hosting the VDA is not in maintenance mode. Restart the VDA once these issues have been addressed. |

**Machine failure type**

| Error Code                                           | Error Code ID | Issue                                                                                   | Action                                                                                                                                                                                                                 |
|------------------------------------------------------|---------------|-----------------------------------------------------------------------------------------|------------------------------------------------------------------------------------------------------------------------------------------------------------------------------------------------------------------------|
| Unknown                                              | -             | -                                                                                       | -                                                                                                                                                                                                                      |
| Unregistered                                         | 3             | -                                                                                       | -                                                                                                                                                                                                                      |
| MaxCapacity<br>(represented as Max Load on Director) | 4             | Machine is reporting itself at maximum capacity i.e. Max Load Index                     | Ensure that all hypervisors are powered on. Add more machines to the affected Delivery Groups by adding more capacity to the hypervisor or by adding more hypervisors.                                                 |
| StuckOnBoot                                          | 2             | The VM did not complete its boot sequence and is not communicating with the hypervisor. | Ensure that the VM booted successfully on the hypervisor. Check for other messages on the VM, such as OS issues. Ensure that the hypervisor tools are installed on the VM. Ensure that the VDA is installed on the VM. |
| FailedToStart                                        | 1             | The VM experienced issues when trying to start on the hypervisor.                       | Check the hypervisor logs.                                                                                                                                                                                             |
| None                                                 | 0             | -                                                                                       | -                                                                                                                                                                                                                      |

**Machine deregistration reason (applicable when failure type is Unregistered or Unknown)**

| Error Code                   | Error Code ID | Issue                                                                                                      | Action                                                                                                                                                                                                                                                                                                                           |
|------------------------------|---------------|------------------------------------------------------------------------------------------------------------|----------------------------------------------------------------------------------------------------------------------------------------------------------------------------------------------------------------------------------------------------------------------------------------------------------------------------------|
| AgentShutdown                | 0             | The VDA experienced a graceful shutdown.                                                                   | Power on the VDA if you do not expect it to be off based on existing power management policies. Review any errors in the event logs.                                                                                                                                                                                             |
| AgentSuspended               | 1             | The VDA is in hibernation or sleep mode.                                                                   | Take the VDA out of hibernation mode. Consider disabling hibernation for Citrix Virtual Apps and Desktops VDAs via power settings.                                                                                                                                                                                               |
| IncompatibleVersion          | 100           | The VDA cannot communicate with the delivery controller due to a mismatch in the Citrix protocol versions. | Align the VDA and delivery controller versions.                                                                                                                                                                                                                                                                                  |
| AgentAddressResolutionFailed | 101           | The delivery controller was not able to resolve the VDA's IP address.                                      | Verify that the VDA machine account exists in AD. If not, create it. Verify that the name and the IP address of the VDA in DNS are accurate. If not, correct them. If widespread, validate the DNS settings on the delivery controllers. Verify DNS resolution from the controller by running the <code>nslookup</code> command. |

---

| Error Code          | Error Code ID | Issue                                                                       | Action                                                                                                                                                                                                                                                                                                                                                                                                                                                     |
|---------------------|---------------|-----------------------------------------------------------------------------|------------------------------------------------------------------------------------------------------------------------------------------------------------------------------------------------------------------------------------------------------------------------------------------------------------------------------------------------------------------------------------------------------------------------------------------------------------|
|                     | 101           | The delivery controller was not able to resolve the VDA's IP address.       | Verify that the VDA machine account exists in AD. If not, create it. Verify that the name and the IP address of the VDA in DNS are accurate. If not, correct them.                                                                                                                                                                                                                                                                                         |
| AgentNotContactable | 102           | A communication issue occurred between the delivery controller and the VDA. | Use a ping to verify that the delivery controller and the VDA can successfully communicate. If not, resolve any firewall or network issues. Refer to the troubleshooting steps listed in Knowledge Center article, <a href="#">Troubleshooting Virtual Delivery Agent Registration with delivery controllers in Citrix Virtual Apps and Desktops (CTX136668)</a> , for common problems that cause communication issues between the controller and the VDA. |

| Error Code                      | Error Code ID | Issue                                                                                                                                                                                  | Action                                                                                                                                                                                                                                                                                                                             |
|---------------------------------|---------------|----------------------------------------------------------------------------------------------------------------------------------------------------------------------------------------|------------------------------------------------------------------------------------------------------------------------------------------------------------------------------------------------------------------------------------------------------------------------------------------------------------------------------------|
|                                 | 102           | A communication issue occurred between the delivery controller and the VDA.                                                                                                            | Refer to troubleshooting steps listed in Knowledge Center article, <a href="#">Troubleshooting Virtual Delivery Agent Registration with delivery controllers in Citrix Virtual Apps and Desktops (CTX136668)</a> , for common problems that cause communication issues between the controller and the VDA. Contact Citrix support. |
| AgentWrongActiveDirectory       | 103U          | An Active Directory discovery misconfiguration occurred. The site-specific OU (where the site controller info is stored in AD) configured in the VDA registry is for a different Site. | Ensure the active directory configuration is correct, or check registry settings.                                                                                                                                                                                                                                                  |
| EmptyRegistrationRequest        | 104           | The registration request sent from the VDA to the delivery controller was empty. This can be due to a corrupt VDA software installation.                                               | Restart the Desktop service on the VDA to restart the registration process and verify that the VDA registers correctly via the application event log.                                                                                                                                                                              |
| MissingRegistrationCapabilities | 105           | The VDA version is not compatible with the delivery controller.                                                                                                                        | Upgrade the VDA or remove the VDA and then reinstall it.                                                                                                                                                                                                                                                                           |

| Error Code                            | Error Code ID | Issue                                                                                                                                                                                                                                                                                | Action                                                                        |
|---------------------------------------|---------------|--------------------------------------------------------------------------------------------------------------------------------------------------------------------------------------------------------------------------------------------------------------------------------------|-------------------------------------------------------------------------------|
| MissingAgentVersion                   | 106           | The VDA version is not compatible with the delivery controller.                                                                                                                                                                                                                      | Reinstall the VDA software if the issue is impacting all machines.            |
| InconsistentRegistrationCapabilities  | 107           | The VDA cannot communicate its capabilities to the Broker. This can be due to incompatibility between the VDA and delivery controller versions. The registration capabilities, which change with each version, are expressed in a form that does not match the registration request. | Align the VDA and delivery controller versions.                               |
| NotLicensedForFeature                 | 108           | The feature you are attempting to use is not licensed.                                                                                                                                                                                                                               | Check your Citrix licensing edition, or remove the VDA and then reinstall it. |
|                                       | 108           | The feature you are attempting to use is not licensed.                                                                                                                                                                                                                               | Contact Citrix support.                                                       |
| UnsupportedCredentialSecurity version | 109           | The VDA and the delivery controller are not using the same encryption mechanism.                                                                                                                                                                                                     | Align the VDA and delivery controller versions.                               |

| Error Code                 | Error Code ID    | Issue                                                                                                   | Action                                                                                                                                                                                                                                                                                                         |
|----------------------------|------------------|---------------------------------------------------------------------------------------------------------|----------------------------------------------------------------------------------------------------------------------------------------------------------------------------------------------------------------------------------------------------------------------------------------------------------------|
| InvalidRegistrationRequest | 110              | The VDA made a registration request to the Broker but the content of the request is corrupt or invalid. | Refer to the troubleshooting steps listed in Knowledge Center article, <a href="#">Troubleshooting Virtual Delivery Agent Registration with delivery controllers in Citrix Virtual Apps and Desktops (CTX136668)</a> , for common problems that cause communication issues between the controller and the VDA. |
| SingleMultiSessionMismatch | 111              | The VDA's operating system type is not compatible with the machine catalog or delivery group.           | Add the VDA to the correct machine catalog type or delivery group containing machines with the same operating system.                                                                                                                                                                                          |
| FunctionalLevelTooLowFor   | 112 Catalog      | The machine catalog is set to a higher VDA functional level than the installed VDA version.             | Verify that the VDA's machine catalog functional level matches that of the VDA. Upgrade or downgrade the machine catalog to match that of the VDA.                                                                                                                                                             |
| FunctionalLevelTooLowFor   | 113 DesktopGroup | The delivery group is set to a higher VDA functional level than the installed VDA version.              | Verify that the VDA's delivery group functional level matches that of the VDA. Upgrade or downgrade the machine catalog to match that of the VDA.                                                                                                                                                              |

| Error Code                  | Error Code ID | Issue                                                                                                                                                                                             | Action                                                                                                                                                                                                                                                                                           |
|-----------------------------|---------------|---------------------------------------------------------------------------------------------------------------------------------------------------------------------------------------------------|--------------------------------------------------------------------------------------------------------------------------------------------------------------------------------------------------------------------------------------------------------------------------------------------------|
| PowerOff                    | 200           | The VDA did not shut down gracefully.                                                                                                                                                             | If the VDA is supposed to be powered on, attempt to start the VDA from Citrix Studio and verify that it boots up and registers correctly.<br>Troubleshoot any boot or registration issues. Review the event logs on the VDA once it is back up to help determine the root cause of the shutdown. |
| AgentRejectedSettingsUpdate | 205           | Settings such as Citrix policies were changed or updated but there was an error in sending the updates to the VDA. This can occur if the updates are incompatible with the installed VDA version. | Upgrade the VDA if necessary. Review whether the updates that were applied are supported with the VDA version.                                                                                                                                                                                   |
| SessionPrepareFailure       | 206           | The Broker did not complete an audit of the sessions that are running on the VDA.                                                                                                                 | If widespread, restart the Citrix Broker Service on the delivery controller.                                                                                                                                                                                                                     |
|                             | 206           | The Broker did not complete an audit of the sessions that are running on the VDA.                                                                                                                 | Contact Citrix support.                                                                                                                                                                                                                                                                          |



| Error Code  | Error Code ID | Issue                                                                                            | Action                                                                                                                                                                                                                                                                                                                                                                                                                                                                                                                                                               |
|-------------|---------------|--------------------------------------------------------------------------------------------------|----------------------------------------------------------------------------------------------------------------------------------------------------------------------------------------------------------------------------------------------------------------------------------------------------------------------------------------------------------------------------------------------------------------------------------------------------------------------------------------------------------------------------------------------------------------------|
| ContactLost | 207           | The delivery controller lost connection with the VDA. This can be caused by network disruptions. | Verify that the Citrix Broker Service is running on the delivery controller and the Desktop service is running on the VDA. Start each if stopped. If already started, restart the Desktop service on the VDA to restart the registration process and verify that the VDA registers successfully. Confirm that the delivery controllers configured for the VDA are accurate via the details in the Application event log. Use a ping to verify that the delivery controller and the VDA can successfully communicate. If not, resolve any firewall or network issues. |
|             | 207           | The delivery controller lost connection with the VDA. This can be caused by network disruptions. | Verify that the Desktop service is running on the VDA. Start if stopped.                                                                                                                                                                                                                                                                                                                                                                                                                                                                                             |

| Error Code                     | Error Code ID | Issue                                                                                                                                                                                                        | Action                                                                                                                                                                                                                                                                                                                                                                                                                                                                    |
|--------------------------------|---------------|--------------------------------------------------------------------------------------------------------------------------------------------------------------------------------------------------------------|---------------------------------------------------------------------------------------------------------------------------------------------------------------------------------------------------------------------------------------------------------------------------------------------------------------------------------------------------------------------------------------------------------------------------------------------------------------------------|
| BrokerRegistrationLimitReached | 207           | The delivery controller has reached the configured maximum number of VDAs that are allowed to concurrently register with it. By default, the delivery controller allows 10,000 concurrent VDA registrations. | Consider adding delivery controllers to the Site or creating a Site. You can also increase the number of VDAs allowed to concurrently register with the delivery controller via the <b>HKEY_LOCAL_MACHINE\Software</b> registry key. See Knowledge Center article, <a href="#">Registry Key Entries Used by Citrix Virtual Apps and Desktops (CTX117446)</a> for more information. Increasing this number might require more CPU and memory resources for the controller. |
| SettingsCreationFailure        | 208           | The Broker did not construct a set of settings and configurations to send to the VDA. If the Broker is unable to gather the data, registration fails and the VDA becomes unregistered.                       | Check the event logs on the delivery controller for any errors. Restart the Broker Service if a specific issue is not evident in the logs. Once the Broker Service is restarted, restart the Desktop service on the affected VDAs and verify that they successfully register.                                                                                                                                                                                             |

| Error Code          | Error Code ID | Issue                                                                                                                                                                                  | Action                                                                                                                                                                                                                                                                                                                                                                                                                                                                                                                     |
|---------------------|---------------|----------------------------------------------------------------------------------------------------------------------------------------------------------------------------------------|----------------------------------------------------------------------------------------------------------------------------------------------------------------------------------------------------------------------------------------------------------------------------------------------------------------------------------------------------------------------------------------------------------------------------------------------------------------------------------------------------------------------------|
|                     | 208           | The Broker did not construct a set of settings and configurations to send to the VDA. If the Broker is unable to gather the data, registration fails and the VDA becomes unregistered. | Restart the Desktop service on the affected VDAs and verify that they successfully register. Contact Citrix support.                                                                                                                                                                                                                                                                                                                                                                                                       |
| SendSettingsFailure | 204           | The Broker did not send settings and configuration data to the VDA. If the Broker can gather the data but is unable to send it, registration fails.                                    | If limited to a single VDA, restart the Desktop service on the VDA to force reregistration and validate that the VDA registers successfully via the application event log.<br>Troubleshoot any errors seen. Refer to the troubleshooting steps listed in Knowledge center article, <a href="#">Troubleshooting Virtual Delivery Agent Registration with delivery controllers in Citrix Virtual Apps and Desktops (CTX136668)</a> , for common problems that cause communication issues between the controller and the VDA. |
| AgentRequested      | 2             | An unknown error occurred.                                                                                                                                                             | Contact Citrix support.                                                                                                                                                                                                                                                                                                                                                                                                                                                                                                    |

---

| Error Code                | Error Code ID | Issue                      | Action                  |
|---------------------------|---------------|----------------------------|-------------------------|
| DesktopRestart            | 201           | An unknown error occurred. | Contact Citrix support. |
| DesktopRemoved            | 202           | An unknown error occurred. | Contact Citrix support. |
| SessionAuditFailure       | 205           | An unknown error occurred. | Contact Citrix support. |
| UnknownError              | 300           | An unknown error occurred. | Contact Citrix support. |
| RegistrationStateMismatch | 302           | An unknown error occurred. | Contact Citrix support. |
| Unknown                   | -             | An unknown error occurred. | Contact Citrix support. |

---

## Third party notices

June 20, 2022

This release of Citrix Virtual Apps and Desktops may include third-party software licensed under the terms defined in the following documents:

- [Citrix Virtual Apps and Desktops Third Party Notices \(PDF Download\)](#)
- [Non-Commercial Software Disclosures For FlexNet Publisher 2017 \(11.15.0.0\) \(PDF Download\)](#)
- [FlexNet Publisher Documentation Supplement Third Party and Open Source Software used in FlexNet Publisher 11.15.0 \(PDF Download\)](#)

## SDKs and APIs

October 8, 2022

Several SDKs and APIs are available with this release. To access the SDKs and APIs, go to [Build anything with Citrix](#). From there, select **Citrix Workspace** to access programming information for Citrix Virtual Apps and Desktops and its related components.

**Note:**

The Citrix Virtual Apps and Desktops SDK and the Citrix Group Policy SDK can be installed as a module or a snap-in. Several component SDKs (such as Citrix Licensing, Citrix Provisioning, and StoreFront) install using only a snap-in.

This product supports PowerShell versions 3 through 5.

## Citrix Virtual Apps and Desktops SDK

This SDK installs automatically as a PowerShell module when you install a Delivery Controller or Studio. This enables you to use this SDK's cmdlets without having to add snap-ins. (Instructions are provided below if you choose to install this SDK as a snap-in.)

### Permissions

You must run the shell or script using an identity that has Citrix administration rights. Although members of the local administrators group on the Controller automatically have full administrative privileges to allow Citrix Virtual Apps or Citrix Virtual Desktops to be installed, Citrix recommends that for normal operation, you create Citrix administrators with the appropriate rights, rather than use the local administrators account.

### Access and run the cmdlets

1. Start a shell in PowerShell: Open Studio, select the **PowerShell** tab, and then click **Launch PowerShell**.
2. To use SDK cmdlets within scripts, set the execution policy in PowerShell. For information about PowerShell execution policy, see the Microsoft documentation.
3. If you want to use the snap-in (rather than the module), add the snap-in using the `Add-PSSnapin` (or `asnp`) cmdlet.

V1 and V2 denote the version of the snap-in. XenDesktop 5 snap-ins are version 1. Citrix Virtual Apps and Desktops, and earlier XenDesktop 7 version snap-ins are version 2. For example, to install Citrix Virtual Apps and Desktops snap-in, type `Add-PSSnapin Citrix.ADIIdentity.Admin.V2`. To import all the cmdlets, type: `Add-PSSnapin Citrix.*.Admin.V*`

You can now use the cmdlets and help files.

- To access the help files for this SDK, select the product or component in the [Categories](#) list, and then select **Citrix Virtual Apps and Desktops SDK**.
- For PowerShell guidance, see [Windows PowerShell Integrated Scripting Environment \(ISE\)](#).

## Group Policy SDK

The Citrix Group Policy SDK enables you to display and configure Group Policy settings and filters. This SDK uses a PowerShell provider to create a virtual drive that corresponds to the machine and user settings and filters. The provider appears as an extension to `New-PSDrive`.

To use the Group Policy SDK, either Studio or the Citrix Virtual Apps and Desktops SDK must be installed.

The Citrix Group Policy PowerShell provider is available as a module or a snap-in.

- To use the module, no additional work is needed.
- To add the snap-in, type `Add-PSSnapin citrix.common.grouppolicy`.

To access help, type: `help New-PSDrive -path localgpo:/`.

To create a virtual drive and load it with settings, type `New-PSDrive <Standard Parameters> [-PSProvider] CitrixGroupPolicy -Controller <string>` where the Controller string is the fully qualified domain name of a Controller in the site you want to connect to and load settings from.

## Citrix Virtual Apps and Desktops REST APIs

With Citrix Virtual Apps and Desktops REST APIs, you can automate the management of resources within a Citrix Virtual Apps and Desktops deployment.

The Citrix Virtual Apps and Desktops REST APIs are available at <https://developer.cloud.com/citrix-workspace/citrix-daas-rest-apis/docs/citrix-virtual-apps-and-desktops-apis>. APIs not applicable to Citrix Virtual Apps and Desktops are marked accordingly. Follow the guidance there to configure access to the API service and use the APIs to manage and optimize your resources.

## Monitor Service OData

The Monitor API allows access to the Monitor Service data using Version 3 or 4 of the OData API. You can create customized monitoring and reporting dashboards based on data queried from the Monitor Service data. OData V.4 is based on the [ASP.NET Web API](#) and supports aggregation queries.

For more information, see the [Monitor Service OData API](#).



© 2024 Cloud Software Group, Inc. All rights reserved. Cloud Software Group, the Cloud Software Group logo, and other marks appearing herein are property of Cloud Software Group, Inc. and/or one or more of its subsidiaries, and may be registered with the U.S. Patent and Trademark Office and in other countries. All other marks are the property of their respective owner(s).